

Instruction Manual

alpha TDS 190

1/8 DIN Total Dissolved Solids Controller
with Temperature display and Transmitter



EUTECH
INSTRUMENTS

Technology Made Easy...

68X276108
Rev 0 11/2004

CE

ISO 9001
CERTIFIED

PREFACE

This manual serves to explain the use of the α TDS 190 controller/transmitter. This manual functions in two ways: first, as a step-by-step guide to help you operate the meter; second, it serves as a handy reference guide.

This manual is written to cover as many anticipated applications of the α TDS 190 controller/transmitter as possible. If there are doubts in the use of the α TDS 190 controller / transmitter, do not hesitate to contact the nearest Eutech Instruments Authorized Distributor.

Eutech Instruments cannot accept any responsibility for damage or malfunction to the controller/transmitter caused by improper use of the instrument. Remember to fill in the guarantee card and mail it to your Authorized Distributor or Eutech Instruments Pte Ltd.

The information presented in this manual is subject to change without notice as improvements are made, and does not represent a commitment on the part of Eutech Instruments Pte Ltd.

Copyright© 2004

All rights reserved.

Rev. 0 11/2004

Eutech Instruments Pte Ltd.

TABLE OF CONTENTS

1	INTRODUCTION	1
2	SAFETY INFORMATION	2
3	OVERVIEW	3
	3.1 FRONT PANEL	3
	3.2 BACK PANEL	4
	3.3 WIRING	5
	3.4 PANEL-MOUNTING THE CONTROLLER	5
	3.5 FERRITE ASSEMBLY	6
4	MEASUREMENT MODE	7
	4.1 MEASUREMENT MODE DISPLAY	7
	4.2 SET POINTS ADJUSTMENTS	8
5	PASSWORD	9
6	TDS CALIBRATION	11
7	TEMPERATURE CALIBRATION	13
8	SETUP MODE	14
	8.1 GENERAL INFORMATION	14
	8.2 SETUP MODE OVERVIEW	15
	8.3 SET POINT 1 – P1.0	16
	8.4 SET POINT 2 – P2.0	18
	8.5 MEASUREMENT RANGE SELECTION – P3.0	20
	8.6 CONFIGURE TEMPERATURE SETTINGS – P4.0	21
	8.7 VIEWING TDS CALIBRATION DATA – P5.0	22
	8.8 VIEWING TDS/ TEMPERATURE ELECTRODE DATA – P6.0	23
	8.9 SETTING TDS FACTOR – P7.0	24
	8.10 CONTROLLER RESET – P8.0	25
9	RELAYS	26
10	TRANSMITTER FUNCTION	26
11	SPECIFICATIONS	27
12	ACCESSORIES	28
13	GENERAL INFORMATION	31

1 INTRODUCTION

Thank you for purchasing the α TDS 190 1/8 DIN TDS Controller. This controller is part of a series of quality process controllers available from Eutech Instruments. These sturdy, economical TDS controllers are designed with the features and reliability of a much more expensive instrument.

Your controller includes:

- Removable terminal blocks for easy connections;
- Two mounting brackets for easy panel mounting;

Some features of this controller are:

- Two set point, two SPDT relay operation
- Scrolling, 14-segment LED guides user easily through setup functions
- Reliable power supply from 85 to 260 V AC, 50/60 Hz or DC withstands voltage fluctuations
- Push-button operation from the front panel
- Single-point calibration for each individual range
- Adjustable hysteresis band prevents rapid contact switching around set-point
- Selectable automatic or manual temperature compensation
- Two-level password protection
- Removable terminal strips for quick and easy connections
- Built-in non volatile memory backup retains setup even if power fails, and lets you configure unit before installation
- Isolated 4-20 mA output for remote monitoring or hard copy recording

2 SAFETY INFORMATION

The Eutech Controller / Transmitter shall be installed and operated only in the manner specified in the Instruction manual. Only skilled, trained or authorized person should carry out installation, setup and operation of the instrument.

Before powering up the unit, make sure that power source it is connected to, is as specified in the top label. Failure to do so may result in a permanent damage to the unit.

The unit has live and exposed parts inside. If it has to be opened, make sure that the power to the unit is off and disconnected.

The unit is Fuse protected. In the event the fuse has to be replaced, use only those as specified in the manual.



The degree of protection against electric shock will be achieved only by observance of the corresponding installation rules.

3 OVERVIEW

3.1 Front Panel

The front panel consists of a 4-digit LED display, 8 LED annunciators and 4 keys.

Annunciators

- | | |
|----------|--|
| 1. REL 1 | Displayed when Relay 1 is activated |
| 2. REL 2 | Displayed when Relay 2 is activated |
| 3. MEAS | Displayed in measurement mode |
| 4. CAL | Displayed in calibration mode |
| 5. SETUP | Displayed in setup mode |
| 6. ppm | Unit of the displayed parameter (parts per million) |
| 7. °C | Unit of the displayed parameter (temperature) |
| 8. ppt | Unit of the displayed parameter (parts per thousand) |

Keys

- | | |
|------------------------|--|
| 9. MODE | Use to toggle between Measurement modes (TDS and temperature). |
| 10. CAL / ENTER | Use to enter Calibration mode.
Use also to enter into levels of the Setup mode and to confirm changes made. |
| 11. SP1 / ▲
SP2 / ▼ | Use to enter Set Point 1 (SP1) or Set Point 2 (SP2) adjustment mode.
Use as increment or decrement keys during Calibration and Setup modes.
Use both keys together in Calibration and Setup modes to escape to Measurement mode. |

12. 14-segment display

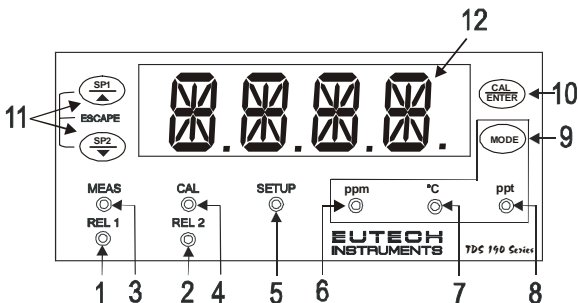

3.2 Back Panel

The back panel consists of three different connectors that can be used with removable terminal blocks (included):

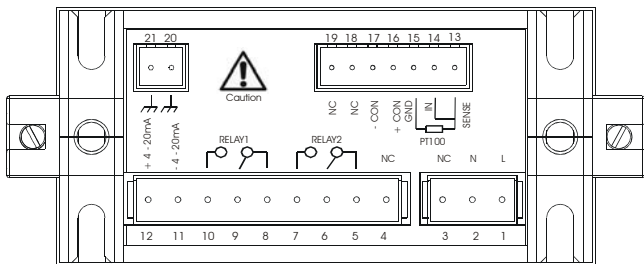

1. VAC live wire
2. VAC neutral wire
3. unused
4. unused
5. Relay 2 deactivated position (normally closed)
6. Relay 2 center pole
7. Relay 2 activated position (normally open)
8. Relay 1 deactivated position (normally closed)
9. Relay 1 center pole
10. Relay 1 activated position (normally open)
11. 4-20 mA connection, negative
12. 4-20 mA connection, positive
13. Pt 100 connection: sense (jumper to terminal 14 if using 2-wire RTD)
14. Pt 100 connection: input
15. Pt 100 connection: ground
16. Conductivity positive terminal
17. Conductivity negative terminal
18. unused
19. unused
20. VAC protective ground wire
21. VAC protective ground wire

3.3 Wiring



Caution: Ensure electrical mains are disconnected before proceeding.

1. Connect the power supply to the three-pin terminal block

- VAC live wire = 1
- VAC neutral wire = 2
- VAC protective ground wire = 20 OR 21

α pha TDS 190 controller accepts voltages from 85 to 260 VAC, 50/60 Hz or DC.

2. Connect the Pt 100 leads to terminals 13 to 15 of the seven-pin terminal block. Either wire can be connected to either terminal. Terminals 13 and 14 must be shunted unless using a 3-wire RTD.

NOTE: α pha TDS 190 is factory set for Automatic temperature compensation. MTC can be selected in Program P4.0.

3. Power on the controller. The display automatically shows the TDS reading, the ppm and 'MEAS' annunciators' lights.

NOTE: In the event Pt 100 is not connected or the connection is broken in the ATC mode, the display flashes 'OR' to alert you.

3.4 Panel-mounting the controller

The supplied mounting hardware allows surface mounting to all panels and protective enclosures. Mounting cut-out size is 91 x 45 mm.

To attach the mounting to the controller:

1. Align the catch to the side of the controller, and insert threaded rods through catch.

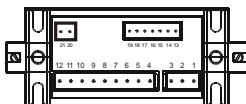

2. Screw the threaded-rod through the catch in a clock-wise direction. Tighten until the catch holds the controller firmly against the back of the panel or protective housing. Repeat on the other side.

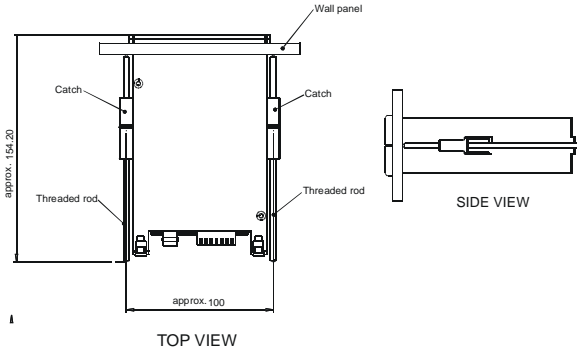

3.5 Ferrite Assembly

The power cable (L, N & E) needs to be connected to the instrument with two turns through the Split Ferrite which is supplied as an accessory with the instrument. It is strongly suggested that the Ferrite element supplied as a standard accessory be installed as described below.

Clamping Ferrite Assembly Process

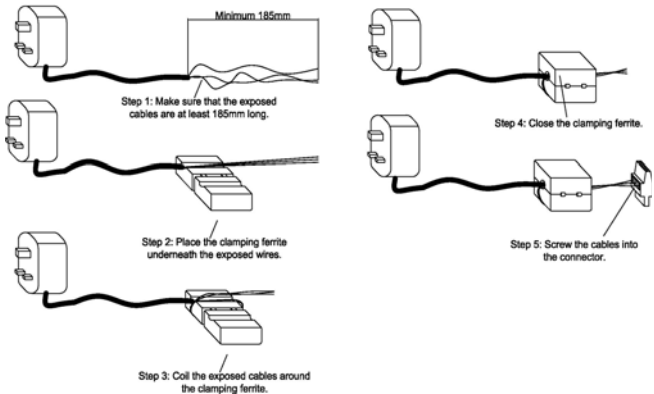

4 MEASUREMENT MODE

The α TDS 190 controller is capable of taking TDS measurement with Automatic (ATC) or Manual (MTC) Temperature Compensation.

The measurements are displayed distinguishingly by the annunciators on the front panel.

4.1 Measurement mode display

Press the MODE key to toggle between TDS and Temperature measurement mode.

Conductivity Measurement Mode

The controller displays the selected TDS range number, R X (X ranges from 1 to 8), for 2 seconds before displaying the TDS measurement. The ppm or ppt annunciator will light up depending on which range is selected.

<i>TDS Range</i>	<i>Range No., R</i>	<i>Resolution</i>	<i>Cell Constant</i>
0.00 – 10.00 ppm	1	0.01 ppm	0.1
0.0 – 100.0 ppm	2	0.1 ppm	0.1
0.0 – 100.0 ppm	3	0.1 ppm	1
0 – 1000 ppm	4	1 ppm	1
0.00 – 5.00 ppt	5	0.01 ppt	1
0.00 – 10.00 ppt	6	0.01 ppt	1
0.0 – 100.0 ppt	7	0.1 ppt	1
0.0 – 100.0 ppt	8	0.1 ppt	10

Temperature Measurement mode

Press MODE key once to view the temperature measurement. The °C annunciator lights up. The display shows ATC or MTC, then the current measured temperature. For selection of temperature compensation ATC or MTC, see Setup program P4.1.

NOTE: After pressing the MODE key to display Temperature, if there is no further key-press, the Controller will automatically revert to TDS Measurement mode after about 30 seconds.

4.2 Set Points Adjustments

You can make quick set points adjustments with the direct access of the Set Points adjustment modes (SP1 and/or SP2). By just pressing the SP1/▲ or SP2/▼ key, you can enter the Set Point adjustment mode and set a new TDS value that will cause your controller to activate.

Set Point 1 (SP1) adjustment mode

This lets you adjust the TDS value in Set Point 1. If this value is crossed, the set point relay 1 LED will light.

1. Press the SP1/▲ key. The screen will scroll P1.1, SP1, and then the current set point value.
2. Press the ▲ or ▼ keys and adjust first relay set point. Default value is 10% of full scale of range selected.
3. Press ENTER to confirm and return to the measurement mode.

NOTE: Press ▲ and ▼ keys together (ESCAPE) at anytime, to return to Measurement mode.

Set Point 2 (SP2) adjustment mode

This lets you adjust the TDS value in Set Point 2. If this value is crossed, the set point relay 2 LED will light.

4. Press the SP2/▲ key. The screen will scroll P2.1, SP2, and then the current set point value.
5. Press the ▲ or ▼ keys and adjust first relay set point. Default value is 90% of full scale of range selected.
6. Press ENTER to confirm and return to the measurement mode.

NOTE: Press ▲ and ▼ keys together (ESCAPE) at anytime, to return to Measurement mode.

NOTE: These modes are only for adjusting relay 1 and/or relay 2 set points values. To set the relays as low or high set points or to set its hysteresis values, you have to make the adjustments from the Setup mode as in Section 8.3 and Section 8.4.

5 PASSWORD

The Setup mode is to be accessed by entering a password code. The direct accessed Set Point adjustment mode (SP1 and SP2) and the Calibration mode can also be accessed through this password code procedure.

The α TDS 190 controller features two separate passwords:

- TDS and Temperature calibration mode password = 011
- Setup program password = 022

To enter the password:

1. Press the MODE key, and within 1 second, press the CAL/ENTER key. The display reads P.WRD.
2. Press ENTER again. The display reads "P.000". The first "0" flashes.
3. Press ENTER again to leave the first digit "0" and to scroll to the next number.
4. Press the ▲ or ▼ keys to change the second digit to the desired password number (1 or 2). Press ENTER.
5. Press the ▲ or ▼ keys to change the second digit to the correct password number (1 or 2). Press ENTER. The display flashes the password that has been entered.

NOTE: If you enter an incorrect digit, press MODE to step backward.

6. Press ENTER again. You are now in Calibration mode or Setup mode, depending on password entered.

NOTE: In the Password Entry mode, if there is no key-press for more than 30 seconds, Controller will automatically revert to measurement

P.WRD

P.000

P.000

P.010

P.020

P.011

P.022

P.011

P.022

6 TDS CALIBRATION

IMPORTANT: When Calibration mode is entered, controller automatically goes into a "HOLD" mode where the 4-20 mA output freezes and relays are de-activated (if it was in an activated condition). Upon return to measurement mode, both 4-20mA output and relay activities resume, depending on settings.

The α TDS 190 controller includes 8 TDS measurement ranges. One-point slope calibration is possible, in each range.

Choose fresh standard solutions, whose value is reasonably close to the measurement value.

Before calibration, make sure electrode is clean. Use iso-propyl alcohol followed by thorough rinsing in distilled water to clean electrode.

Important: To achieve a successful TDS calibration, two conditions must be satisfied:

1. Difference between measured value of standard solution, and actual value of standard solution, must be within $\pm 40\%$. (e.g. if value of standard solution is 1500 ppm, then allowable measured values by controller must be within 2100ppm $\{+ 40\%$ and 900 ppm $\{- 40\%$); and
2. The lowest possible value must be at least 10% of full scale (e.g. if range of 0 to 100.0 ppm selected, min. measured value at calibration, must be at least 10.0 ppm).



Err 1

If any or both conditions are not satisfied, controller will display ERR 1 (blinking).

1. Press CAL / ENTER key to directly access the Calibration mode when the unit is in conductivity measurement mode. Controller displays the value of the standard solution.

NOTE: Instead of pressing the CAL/ENTER key, you can also enter the Calibration mode using the password code procedure as explained in Section 5.

2. Use electrode to agitate standard solution to obtain a homogeneous solution and to dislodge any bubbles. Allow electrode time to stabilize with solution temperature.
3. Use \blacktriangle / \blacktriangledown keys to adjust displayed readings to the value of the standard solution. Press ENTER.

- If any of the two conditions mentioned above is not satisfied, controller will display ERR1, blinking.
- If calibration is successful, Controller displays DONE, blinking. Press ENTER to revert to TDS measurement mode (Relays and 4-20 mA output resume previous settings).

NOTE: To clear the ERR1 display and return to calibration mode, press ▲ / ▼ keys together.

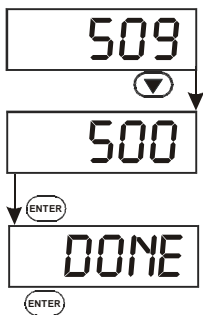

Notes:

You can view the calibrated TDS value from Setup program. See Setup program P5.0.

Controller displays calibrated TDS point for selected range.

If calibration is not done for the selected range, controller displays '- - - -'.

If after thorough cleaning of electrode and ERR1 is displayed after an attempted calibration, consider changing electrode.

7 TEMPERATURE CALIBRATION

IMPORTANT: When Calibration mode is entered, controller automatically goes into a "HOLD" mode where the 4-20 mA output freezes and relays are de-activated (if it was in an activated condition). Upon return to measurement mode, both 4-20mA output and relay activities resume, depending on settings.

This controller features selectable Automatic Temperature Compensation (ATC) or Manual Temperature Compensation (MTC).

ATC: ATC mode requires a Pt 100 temperature element. ATC automatically compensates for temperature fluctuations. ATC temperature readings can be offset by ± 10 °C.

Important: If there is no temperature element wired to controller and ATC is selected on, screen will flash in TDS mode and an error message (OR) is displayed in temperature mode.

MTC: MTC lets you select a specific value at which temperature will be compensated. You can select a manual temperature value from 0 to 50°C. Factory default is 25.0°C.

See Setup program P4.0 for instructions on ATC or MTC selection.

To offset temperature:

1. Press MODE to select °C mode. Display shows MTC or ATC, then temperature.
2. Press CAL / ENTER key to directly access the offset mode when the unit is in temperature measurement mode.

NOTE: Instead of pressing the CAL/ENTER key, you can also enter the offset mode using the password code procedure as explained in Section 5.

3. The screen will flash current °C reading.
4. For ATC: Determine temperature of solution with an accurate meter (such as the Temp 5). Press ▲ or ▼ keys to offset °C value on controller display to match value of the solution you are measuring.
For MTC: Press ▲ or ▼ keys to offset °C value on controller display to match desired value.
5. Press ENTER. The display flashes "DONE" for about 3 seconds and returns to measurement mode.

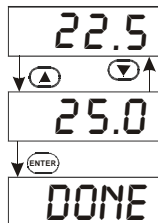

8 SETUP MODE

8.1 General Information

IMPORTANT: When Setup mode is entered, controller automatically goes into a "HOLD" mode where the 4-20 mA output freezes and relays are de-activated (if it was in an activated condition). Upon return to measurement mode, both 4-20mA output and relay activities resume, depending on settings.

To enter setup mode:

1. Key in password "022" using method described in section 5.
2. Press ▲ or ▼ keys to display various sub-menus shown here.
3. When a sub-menu item is displayed, press ENTER key to enter that sub-menu.
4. Press ▲ and ▼ keys together (ESCAPE) to leave Setup mode and return to Measurement mode (Relays and 4-20 mA output resume previous settings).

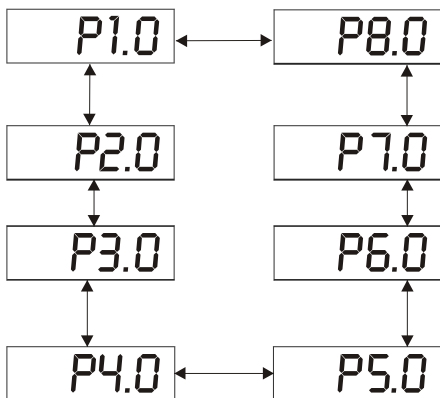

8.2 Setup mode overview

P1.0: Set Point 1

P1.1: select relay 1 set point value

P1.2: select relay 1 as low or high set point

P1.3: set relay 1 hysteresis value

P2.0: Set Point 2

P2.1: select relay 2 set point value

P2.2: select relay 2 as low or high set point

P2.3: set relay 2 hysteresis value

P3.0: Range

P3.1: select measurement range (with the corresponding cell constant value).
Eight measurement ranges are available.

P4.0: Temperature Data

P4.1: select ATC or MTC

P4.2: select temperature coefficient value

P4.3: select normalization temperature

P5.0: TDS Calibration points

P5.1: view TDS value at which calibration was performed

P6.0 Electrode Properties

P6.1: view cell constant value after calibration

P6.2: view temperature offset value after calibration (only if in ATC mode)

P7.0: TDS Factor

P7.1: select TDS factor for appropriate application

P8.0: Reset

P8.1: select yes/no to reset controller to factory defaults

8.3 Set Point 1 – P1.0

Setup program P1.0 allows you to set parameters for relay 1.

P1.1: select relay 1 set point value

P1.2: select relay 1 as low or high set point

P1.3: set relay 1 hysteresis value (dead band)

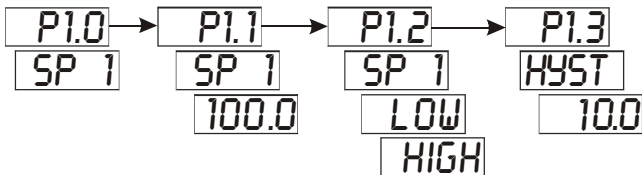

Press ▲ and ▼ keys together (ESCAPE) at anytime, to leave Setup mode and return to Measurement mode.

P1.1: Select relay set point value

Set the TDS value that will activate Relay 1. If measured value overshoots or undershoots Set Point value, Relay 1 will be activated and corresponding LED on front panel will light.

1. Key in password "022" as per procedure in Section 5.
2. Screen will scroll P1.0 and SP1. Press ENTER.
3. Screen will scroll P1.1, SP1, then current set point value.
4. Press ▲ or ▼ keys and adjust first relay set point. Default value is 10% of full scale of range selected.
5. Press ENTER to confirm and continue to step three of P1.2, or press ▲ and ▼ keys together to return to P1.0. Press ▲ and ▼ keys together again, to return to the TDS measurement mode.

P1.2: Set relay as high or low set point

Select low set point to activate Relay when measured value undershoots Set point; select high set point to activate Relay when measured value overshoots Set point.

Using both SP1 and SP2, you can select lo/lo, lo/hi, hi/lo or hi/hi set points.

1. Key in password "022" as per procedure in Section 5.
2. The screen will scroll P1.0 and SP1. Press ENTER twice.
3. The screen will scroll P1.2, SP1, and LOW (or HIGH).
4. Use ▲ or ▼ keys to toggle between LOW and HIGH.
5. Press ENTER to confirm and continue to step 3 of P1.3, or press ▲ and ▼ keys together to return to P1.0. Press ▲ and ▼ keys together again, to return to TDS measurement mode.

P1.3: Set Hysteresis value

Hysteresis prevents rapid contact switching if measured value is fluctuating near the set point. Once activated, relay will not de-activate until measured value reaches set point plus hysteresis value.

Example: Low set point is 100.0 ppm and hysteresis 10.0 ppm, relay will activate when value drops below 100.0 ppm, but will not de-activate till measured TDS value rises above 110.0 ppm.

Default hysteresis value is 5% of full scale. The hysteresis window can be set to any value within the range shown below:

<i>TDS Range</i>	<i>Range No., R</i>	<i>Hysteresis Window</i>
0.00 – 10.00 ppm	1	0.00 – 1.00 ppm
0.0 – 100.0 ppm	2	0.0 – 10.0 ppm
0.0 – 100.0 ppm	3	0.0 – 10.0 ppm
0 – 1000 ppm	4	0 – 100 ppm
0.00 – 5.00 ppt	5	0.00 – 0.50 ppt
0.00 – 10.00 ppt	6	0.00 – 1.00 ppt
0.0 – 100.0 ppt	7	0.0 – 10.0 ppt
0.0 – 100.0 ppt	8	0.0 – 10.0 ppt

1. Key in password "022" as per procedure in Section 5.
2. The screen will scroll P1.0 and SP1. Press ENTER three times.
3. The screen will scroll P1.3, HYS1, and current hysteresis value.
4. Press ▲ or ▼ keys to adjust hysteresis value (0 to 10% of full scale).
5. Press ENTER to confirm. Press ▲ and ▼ keys together to return to P1.0. Press ▲ and ▼ keys together again, to return to TDS measurement mode.

8.4 Set Point 2 – P2.0

Setup program P2.0 allows you to set parameters for relay 2.

P2.1: select relay 2 set point value

P2.2: select relay 2 as low or high set point

P2.3: set relay 2 hysteresis value (dead band)

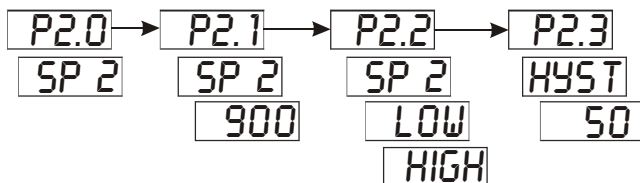

Press ▲ and ▼ keys together (ESCAPE) at anytime, to leave Setup mode and return to Measurement mode.

P2.1: Select relay set point value

Set the TDS value that will activate Relay 2. If measured value overshoots or undershoots Set Point value, Relay 2 will be activated and corresponding LED on front panel will light.

1. Key in password "022" as per procedure in Section 5.
2. Press ▲ key until screen displays P2.0 and SP2. Press ENTER.
3. The screen will scroll P2.1, SP2, then current set point value.
4. Press ▲ or ▼ keys and adjust second relay set point. Default value is 90% of full scale of range selected.
5. Press ENTER to confirm and continue to step three of P2.2, or press ▲ and ▼ keys together to return to P2.0. Press ▲ and ▼ keys together to return to TDS measurement mode.

P2.2: Set relay as high or low set point

Select low set point to activate Relay when measured value undershoots Set point; select high set point to activate Relay when measured value overshoots Set point.

Using both SP1 and SP2, you can select lo/lo, lo/hi, hi/lo or hi/hi set points.

1. Key in password "022" as per procedure in Section 5.
2. Press ▲ key until screen displays P2.0 and SP2. Press ENTER twice.
3. The screen will scroll P2.2, SP2, and LOW (or HIGH).
4. Press the ▲ or ▼ keys to toggle between LOW and HIGH.
5. Press ENTER to confirm and continue to step 3 of P2.3, or press ▲ and ▼ keys together to return to P2.0. Press ▲ and ▼ keys together to return to TDS measurement mode.

P2.3: Set Hysteresis value

Hysteresis prevents rapid contact switching if measured value is fluctuating near the set point. Once activated, relay will not de-activate until measured value reaches set point plus hysteresis value.

Example: High set point is 900 ppm and hysteresis 50 ppm, relay will activate when value rises above 900 ppm, but will not de-activate till measured TDS value drops below 850 ppm.

Default hysteresis value is 5% of full scale. The hysteresis window can be set to any value within the range shown below:

<i>TDS Range</i>	<i>Range No., R</i>	<i>Hysteresis Window</i>
0.00 – 10.00 ppm	1	0.00 – 1.00 ppm
0.0 – 100.0 ppm	2	0.0 – 10.0 ppm
0.0 – 100.0 ppm	3	0.0 – 10.0 ppm
0 – 1000 ppm	4	0 – 100 ppm
0.00 – 5.00 ppt	5	0.00 – 0.50 ppt
0.00 – 10.00 ppt	6	0.00 – 1.00 ppt
0.0 – 100.0 ppt	7	0.0 – 10.0 ppt
0.0 – 100.0 ppt	8	0.0 – 10.0 ppt

1. Key in password "022" as per procedure in Section 5.
2. The screen will scroll P2.0 and SP2. Press ENTER three times.
3. The screen will scroll P2.3, HYS2, and current hysteresis value.
4. Press ▲ or ▼ keys to adjust hysteresis value (0 to 10% of full scale).
5. Press ENTER to confirm. Press ▲ and ▼ keys together to return to P2.0. Press ▲ and ▼ keys together to return to TDS measurement mode.

8.5 Measurement Range Selection – P3.0

Setup program P3.0 is for selecting the range of measurement.

P3.1: select measurement range and corresponding cell constant

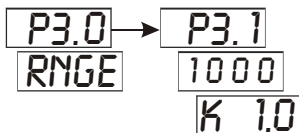

Press ▲ and ▼ keys together (ESCAPE) at anytime, to leave the Setup mode and return to Measurement mode.

P3.1: Select Measurement Range

Set controller to the specific range of measurement. Ensure the cell you have connected to the controller has the same cell constant as that stated in the range.

1. Key in the password "022" as per procedure in Section 5.
2. Press ▲ key until screen displays P3.0 and RNGE. Press ENTER.
3. The screen will scroll P3.1 and the selected range.
4. Press ▲ or ▼ keys to select appropriate range and cell.

Available ranges are as follows (Default range is highlighted):

<i>TDS Range</i>	<i>Cell Constant</i>	<i>4 mA current</i>	<i>20 mA current</i>
0.00 – 10.00 ppm	0.1	0.00 ppm	10.00 ppm
0.0 – 100.0 ppm	0.1	0.0 ppm	100.0 ppm
0.0 – 100.0 ppm	1	0.0 ppm	200.0 ppm
<u>0 – 1000 ppm</u>	<u>1</u>	<u>0 ppm</u>	<u>1000 ppm</u>
0.00 – 5.00 ppt	1	0.00 ppt	5.0 ppt
0.00 – 10.00 ppt	1	0.00 ppt	10.0 ppt
0.0 – 100.0 ppt	1	0.0 ppt	100.0 ppt
0.0 – 100.0 ppt	10	0.0 ppt	100.0 ppt

5. Press ENTER to confirm (The set points 1 & 2, TDS and Temperature calibration are reset to default values).
6. Press ▲ and ▼ keys together (ESCAPE) to return to P3.0. Press the ▲ and ▼ keys together again, to return to measurement mode.

8.6 Configure Temperature Settings – P4.0

Setup program P4.0 is for selecting ATC or MTC, set temperature coefficient values, and select normalization temperature

P4.1: ATC or MTC mode (default : ATC mode)

P4.2: set temperature coefficient (default : 2.10 %)

P4.3: set Normalization temperature (default : 25.0 °C)

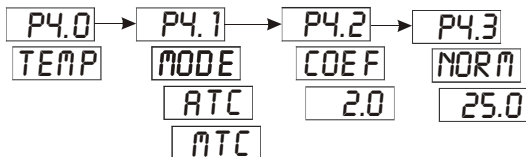

P4.1: Selecting ATC or MTC

1. Key in the password "022" as per procedure in Section 5.
2. Press ▲ key until screen displays P4.0 and TEMP. Press ENTER.
3. Screen will scroll P4.1, MODE, then either ATC or MTC.
4. Press the ▲ or ▼ keys to select either ATC or MTC. Press ENTER.
5. Proceed to P4.2 or press the ▲ and ▼ keys together to return to P4.0. Press the ▲ and ▼ keys together again, to return to TDS measurement mode.

P4.2: Setting Temperature Coefficient

1. Key in the password "022" as per procedure in Section 5.
2. Press ▲ key until screen displays P4.0 and TEMP. Press ENTER until screen shows P4.2.
3. Screen will scroll P4.2, COEF, then 2.1 (to indicate 2.1%).
4. Press the ▲ or ▼ keys to change the temperature coefficient value (adjustable range: 0.0% to 5.0 %). Press ENTER to confirm.
5. Proceed to P4.3 or press the ▲ and ▼ keys together to return to P4.0. Press the ▲ and ▼ keys together again, to return to TDS measurement mode.

P4.3: Setting Normalization Temperature

1. Key in the password "022" as per procedure in Section 5.
2. Press ▲ key until screen displays P4.0 and TEMP. Press ENTER until screen shows P4.3.
3. Screen will scroll P4.3, then NORM, then 25.0.
4. Press ▲ or ▼ keys to change the normalization temperature value (adjustable range: 10.0°C to 30.0°C). Press ENTER to confirm.
5. Press ▲ and ▼ keys together (ESCAPE) twice, to return to measurement mode.

8.7 Viewing TDS Calibration Data – P5.0

Program 5 is a “view only” option, which displays the value at which calibration was performed.

P5.1: view Calibrated TDS value (if no calibration performed for this range, controller displays ‘- - -’).

These parameters will change each time you recalibrate the controller.

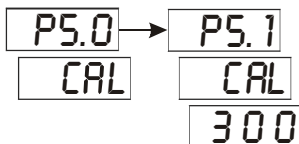

Press ▲ and ▼ keys together (ESCAPE) at anytime, to leave the Setup mode and return to Measurement mode.

P5.0: Viewing Calibrated TDS data

1. Key in the password “022” as per procedure in Section 5.
2. Press ▲ key until screen displays P5.0 and CAL. Press ENTER.
3. Screen will scroll P5.1, ‘CAL’, then Calibrated value (in ppm or ppt).
4. Press ▲ and ▼ keys together (ESCAPE) twice, to return to measurement mode.

8.8 Viewing TDS/ Temperature Electrode Data – P6.0

Program 6 has two "view only" options that let you check the electrode parameters for diagnostic purposes.

P6.1: view revised cell constant value of electrode

P6.2: view temperature probe offset (ATC on only)

These parameters will change each time you recalibrate the controller.

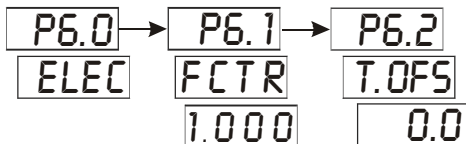

Press ▲ and ▼ keys together (ESCAPE) at anytime, to leave the Setup mode and return to Measurement mode.

P6.1: Viewing TDS electrode data

1. Key in the password "022" as per procedure in Section 5.
2. Press ▲ key until screen displays P6.0 and ELEC. Press ENTER.
3. Screen will scroll P6.1, 'FCTR' then cell constant factor. Each time a calibration is performed, the value of the cell constant factor will be updated.
4. Press ▲ and ▼ keys together (ESCAPE) to return to P6.0 or press ENTER to view Temperature electrode data.

P6.2: Viewing Temperature electrode data

5. Follow procedure from above (P6.1) until step 3 and press ENTER.
6. Screen will scroll P6.2, 'T.OFS' (Temperature Offset), then amount of offset (in °C).
7. Press ENTER or press ▲ and ▼ keys together (ESCAPE) twice, to return to measurement mode.

8.9 Setting TDS Factor – P7.0

Program 7 allows the TDS factor to be selected, depending on the application.

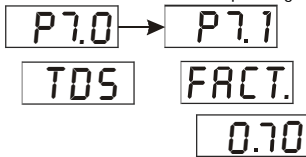

P7.1: Setting TDS Factor

1. Key in the password "022" as per procedure in Section 5.
2. Press ▲ key until screen displays P7.0 and TDS. Press ENTER.
3. Screen will scroll P7.1, 'FACT.' then TDS factor. (Default is 0.70)
4. Press the ▲ or ▼ keys to change TDS factor (0.40 to 1.0). Press ENTER to confirm.
5. Press ▲ and ▼ keys together (ESCAPE) to return to P7.0.

8.10 Controller Reset – P8.0

Program 8 gives an option to reset the controller to factory default values.

- TDS range remains unchanged based on last selected range
- All calibration data and TDS factor are reset
- SP 1 is reset to 10 % of full scale and LOW
- SP 2 is reset to 90 % of full scale and HIGH
- Hysteresis for both set points is reset to 5 % of full scale
- Temperature compensation mode remains unchanged (ATC or MTC)
- In MTC mode, temperature value is reset to 25.0 °C
- Temperature Coefficient is reset to 2.1%
- Normalization Temperature is reset to 25.0°C

NOTE: ATC temperature offset is NOT reset

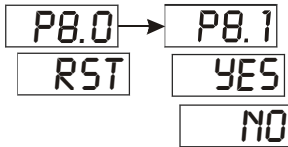

Press ▲ and ▼ keys together (ESCAPE) at anytime, to leave the Setup mode and return to Measurement mode.

P8.0: Controller reset

1. Key in the password "022" as per procedure in Section 5.
2. Press ▲ key until screen displays P8.0 and RST. Press ENTER.
3. Screen will scroll P8.1, then 'No'.
4. Press ▲ or ▼ keys to toggle between YES and NO. Press ENTER to confirm selection.
5. Press ▲ and ▼ keys together (ESCAPE) to return to P8.0. Press ▲ and ▼ keys together again, to return to measurement mode.

9 RELAYS

The α TDS 190 features two SPDT non-powered relays; rated for 6A at 110 VAC, 250 VAC maximum. When your process exceeds the set parameters of a relay set point, the REL 1 or REL 2 indicator will light up.

To set parameters for relay 1 and relay 2, see Setup programs P1.0 and P2.0.

10 TRANSMITTER FUNCTION

If remote data logging is required, a 4-20 mA current loop can be connected. The current will be proportional to the TDS value displayed on the panel and according to the measurement range selected.

<i>TDS Range</i>	<i>Range No., R</i>	<i>Cell Constant</i>	<i>4 mA current</i>	<i>20 mA current</i>
0.00 – 10.00 ppm	1	0.1	0.00 ppm	10.00 ppm
0.0 – 100.0 ppm	2	0.1	0.0 ppm	100.0 ppm
0.0 – 100.0 ppm	3	1	0.0 ppm	200.0 ppm
0 – 1000 ppm	4	1	0 ppm	1000 ppm
0.00 – 5.00 ppt	5	1	0.00 ppt	5.0 ppt
0.00 – 10.00 ppt	6	1	0.00 ppt	10.0 ppt
0.0 – 100.0 ppt	7	1	0.0 ppt	100.0 ppt
0.0 – 100.0 ppt	8	10	0.0 ppt	100.0 ppt

The 4-20 mA current loop can drive a load resistance of no more than 200 Ω .

11 SPECIFICATIONS

<i>TDS Range</i>	<i>Resolution</i>	<i>Cell Constant</i>
0.00 – 10.00 ppm	0.01 ppm	0.1
0.0 – 100.0 ppm	0.1 ppm	0.1
0.0 – 100.0 ppm	0.1 ppm	1
0 – 1000 ppm	1 ppm	1
0.00 – 5.00 ppt	0.01 ppt	1
0.00 – 10.00 ppt	0.01 ppt	1
0.0 – 100.0 ppt	0.1 ppt	1
0.0 – 100.0 ppt	0.1 ppt	10
Relative Accuracy	± 1 % of full scale	
Temperature	-10 to 110 °C	
Resolution/Accuracy	0.1 / ± 0.5 °C	
Sensor	Pt 100 (3-wire)	
Temperature Compensation	Automatic / Manual (0 to 50 °C)	
Temperature Coefficient	0.0 to 5.0 %	
TDS Factor	0.40 to 1.0	
Normalization Temperature	10.0°C to 30.0°C	
<i>Set-point And Controller Functions</i>		
Function	Limit Control	
Switching Hysteresis	0 to 10% of full scale	
Contact Outputs, Controller	2 SPDT relays	
Switching Voltage / Current / Power	Max 250 VAC / Max 3A / Max 600 VA	
Signal Output / Load	4-20 mA galvanically isolated / 200 Ω	
<i>Electrical Data And Connections</i>		
Power Requirements	85 to 260 VAC, 50/60 Hz or DC	
Rated Input Current (MAX)	100 mA	
Insulation Category	II	
Connection Terminals	3 Detachable connectors (3-pin; 7-pin & 9-pin terminal blocks) + 1 FIXED CONNECTOR	
Main Fuse	250 mA, Anti-surge (BUSSMAN S504+250mA)	
<i>Environmental Conditions</i>		
Ambient Temp. Operating Range	- 10 to 50 °C (14 to 122 °F)	
Rel. Humidity	10 to 95 % (non-condensing)	
<i>Mechanical Specifications</i>		
Dimensions (Panel Housing – W x H x D)	96 x 48 x 150 mm	
Weight	300g (350g boxed)	

12 ACCESSORIES

Product Description	Code no.
Conductivity cell, Epoxy body, Graphite sensor, w/3-wire Pt100, k = 0.1	ECCONSEN89X
Conductivity cell, Epoxy body, Graphite sensor, w/3-wire Pt100, k = 1.0	ECCONSEN88X
Conductivity 2 Cell type probe, 0.1 - 200 μ S; Cell constant, K=0.1 with integrated Pt 100, Material SS316 and 25ft cable (open-ended)	EC-CS10-0-1S
Conductivity 2 Cell type probe, up to 200 mS; Cell constant, K=1.0 with integrated Pt 100, Material SS316 and 25ft cable (open-ended)	EC-CS10-1-0S

Note:

Please contact your authorised distributor or dealer for the prices of extension measuring cables and other accessories like tee joints, electrode assembly, and calibration solutions.

Appendix 1: Simple Explanation on the Function of Hysteresis

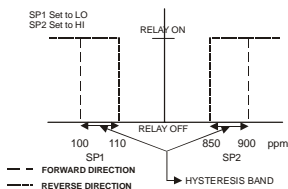

The controller relay activates when the set-point is reached. In the reverse direction, it does not de-activate when the value reaches the set-point. Instead, it continues to be active till the value reaches the amount set by the Hysteresis band.

Appendix 2: Factory Defaults

Resetting the controller to factory default settings (See program P8.0) clears all calibration data and most other setup functions.

The following settings will remain unchanged:

1. Measurement range
2. Temperature compensation mode (ATC or MTC)
3. Temperature offset calibration value, if in ATC mode.

<i>TDS Defaults</i>	
TDS range	Remains unchanged at last selected range
Set point 1	10% full scale / Hyst. 5% full scale / Low
Set point 2	90% full scale / Hyst. 5% full scale / High
TDS Factor	0.70
<i>Temperature Defaults</i>	
Temp. Compensation mode	remains unchanged
MTC mode	reset to 25°C if in MTC mode
ATC mode	remains at last calibration if in ATC mode
Temperature Coefficient	2.1 %
Normalization Temperature	25.0 °C

Appendix 3: External Relays

The relays on the α TDS 190 series controller are rated for 6 amps at 110 VAC and can be wired directly to your final control element (provided its power requirements does not exceed this). However, to preserve the life of your controller, or if higher power is needed, it is recommended that you use the controller relay to drive an external relay.

Diagram below shows a typical installation. Wiring should be changed appropriately if normally closed (N.C.) operation is desired.

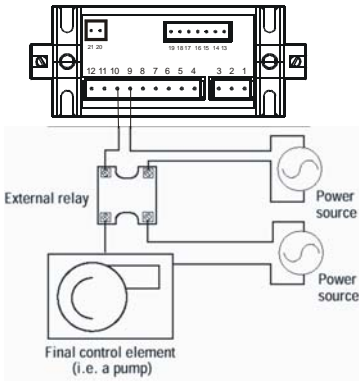

13 GENERAL INFORMATION

Warranty

Eutech Instruments warrants this product to be free from significant deviations in material and workmanship for a period of one year from the date of purchase. If repair is necessary and has not been the result of abuse or misuse within the warranty period, please return by freight pre-paid and amendment will be made without any charge. Eutech Instruments' Customer Service Dept. will determine if product problem is due to deviations or customer abuse. Out of warranty products will be repaired on a charge basis.

Return of Goods

Authorisation must be obtained from Eutech Instruments' Customer Service Dept. to issue a RGA (Return of Goods Authorisation) number before returning items for any reason. When applying for authorisation, please include data requiring the reason of return. Items must be carefully packed to prevent damage in shipment and insured against possible damage or loss. Eutech Instruments will not be responsible for any damage resulting from careless or insufficient packing.

Warning: Shipping damage as a result of inadequate packaging is the user/distributor's responsibility, whoever applicable. Please follow the guidelines below before shipment.

Guidelines for Returning Unit for Repair

Use the original packaging material, if possible when shipping the unit for repair. Otherwise wrap it with bubble pack and use a corrugated box for better protection. Include a brief description of any faults suspected for the convenience of Customer Service Dept., if possible.

For more information on Eutech Instruments products, contact your nearest Eutech Instruments distributor or visit our website listed below:

Manufactured by:

Eutech Instruments Pte Ltd.

Blk 55, Ayer Rajah Crescent,

#04-16/24 Singapore 139949

Tel: (65) 6778 6876

Fax: (65) 6773 0863

E-mail: marketing@eutechinst.com

Web-site: <http://www.eutechinst.com>

Distributed by: