



DigitalFlow™ GF868

Panametrics Ultrasonic Flowmeter for Flare Gas

Programming Manual (1-Channel)



DigitalFlow™ GF868

Panometrics Ultrasonic Flowmeter for Flare Gas



Programming Manual (1-Channel)

910-194P1D1

March 2008

The *DigitalFlow GF868* is a GE Panometrics product. GE Panometrics has joined other GE high-technology businesses under a new name—GE Sensing & Inspection Technologies.



Warranty

Each instrument manufactured by GE Sensing, Inc. is warranted to be free from defects in material and workmanship. Liability under this warranty is limited to restoring the instrument to normal operation or replacing the instrument, at the sole discretion of GE. Fuses and batteries are specifically excluded from any liability. This warranty is effective from the date of delivery to the original purchaser. If GE determines that the equipment was defective, the warranty period is:

- one year for general electronic failures of the instrument
- one year for mechanical failures of the sensor

If GE determines that the equipment was damaged by misuse, improper installation, the use of unauthorized replacement parts, or operating conditions outside the guidelines specified by GE, the repairs are not covered under this warranty.

The warranties set forth herein are exclusive and are in lieu of all other warranties whether statutory, express or implied (including warranties of merchantability and fitness for a particular purpose, and warranties arising from course of dealing or usage or trade).

Return Policy

If a GE Sensing, Inc. instrument malfunctions within the warranty period, the following procedure must be completed:

1. Notify GE, giving full details of the problem, and provide the model number and serial number of the instrument. If the nature of the problem indicates the need for factory service, GE will issue a RETURN AUTHORIZATION number (RA), and shipping instructions for the return of the instrument to a service center will be provided.
2. If GE instructs you to send your instrument to a service center, it must be shipped prepaid to the authorized repair station indicated in the shipping instructions.
3. Upon receipt, GE will evaluate the instrument to determine the cause of the malfunction.

Then, one of the following courses of action will then be taken:

- If the damage is covered under the terms of the warranty, the instrument will be repaired at no cost to the owner and returned.
- If GE determines that the damage is not covered under the terms of the warranty, or if the warranty has expired, an estimate for the cost of the repairs at standard rates will be provided. Upon receipt of the owner's approval to proceed, the instrument will be repaired and returned.

Table of Contents

Chapter 1: Programming Site Data

Introduction.....	1-1
Using the Keypad	1-2
Obtaining On-line Help	1-6
Using the Console Control Keys	1-7
Audio Alarm Volume	1-7
Stopwatch Totalizer	1-7
Display Brightness.....	1-7
Display Contrast.....	1-7
Entering Programming Mode	1-8
Activating the Channel.....	1-9
Entering System Data	1-10
Entering System Units	1-10
Entering Volumetric Data	1-10
Entering Totalizer Data.....	1-11
Entering Mass Flow Data.....	1-11
Entering Pipe Data	1-12
Special Transducers	1-12
Pipe OD	1-12
Pipe Wall.....	1-13
Path Length	1-13
Axial Length.....	1-13
Reynolds Correction	1-13
Calibration Factor	1-13
Setting Up Inputs/Outputs	1-15
Selecting Error Handling	1-15
Setting Up Analog Outputs	1-16
Option Card Alarms.....	1-17
Setting Up the Totalizer/Frequency Outputs.....	1-18
Setting up the Analog Inputs	1-19
Setting up RTD Inputs.....	1-20
Entering the Zero Cutoff	1-20
Setting Up Temperature and Pressure Inputs	1-21
Entering Setup Data	1-23
Setting Transducer Signal Limits.....	1-23
Setting Response Time.....	1-29
Initializing the System.....	1-29
Setting Advanced Parameters.....	1-30
Setting the Clock	1-32
Setting the Date	1-32
Setting the Time	1-32
Setting Up Serial Communications	1-34
MODBUS (RS485) Parameters	1-35
MODBUS/TCP Parameters.....	1-35
MODBUS Register Map.....	1-37

Table of Contents (cont.)

Chapter 1: Programming Site Data (cont.)

Saving Site Data	1-39
Recalling a Site.....	1-40
Activating Security	1-41

Chapter 2: Displaying Data

Introduction	2-1
The BIG Submenu	2-2
The DUAL Submenu	2-3
The GRAPH Submenu.....	2-4
Setting Up the GRAPH Format.....	2-4
Using the GRAPH Format	2-5
The LOG Submenu	2-7
Entering the LOG Submenu	2-7
Numeric Format.....	2-8
Graphical Format.....	2-9
Displaying the Transducer Signal	2-11
Setting the LCD Backlight.....	2-14
Activating Sleep Mode.....	2-15

Chapter 3: Logging Data

Introduction	3-1
Creating a Standard Log.....	3-2
Log Type.....	3-3
STARTTIME Prompt	3-3
START DATE Prompt	3-4
END TIME Prompt.....	3-4
END DATE Prompt.....	3-5
DURATION Prompt.....	3-5
LOG TIME Prompt.....	3-5
TIME INCREMENT Prompt	3-5
Checking the Memory	3-7
Stopping a Log.....	3-8
Creating an ERROR Log.....	3-9
Log Type.....	3-10
STARTTIME Prompt	3-10
START DATE Prompt	3-11

Table of Contents (cont.)

Chapter 4: Printing Data

Introduction.....	4-1
Print Live Data	4-2
Numeric Format.....	4-2
Graphical Format.....	4-3
Printing Logs	4-5
Numeric Format.....	4-5
Graphical Format.....	4-6
Print Site File	4-7
Stop Printing	4-8
Setting Up a Printer.....	4-9
Printing Signal Array Data	4-10
Printing RTD Data	4-12

Chapter 5: Clearing Data

Introduction.....	5-1
Reset Totals.....	5-2
Deleting Site Files.....	5-3
Deleting Log Files.....	5-4

Chapter 6: Serial Communications

Introduction.....	6-1
Wiring the RS232 Interface	6-1
Checking the GF868 Baud Rate	6-2
Setting Up the Terminal Software and Transferring Data	6-2
Windows 3.X Systems.....	6-3
Windows 9X/NT Systems.....	6-4
The Optional RS485 Serial Interface	6-5
Interface Converter Mounting.....	6-5
Point-To-Point Wiring	6-6
Multi-Point Wiring	6-7
Setting Up an Ethernet Connection.....	6-10
Setting Up a MODBUS/TCP Connection	6-11

Appendix A: Menu Maps

Appendix B: Data Records

Option Cards Installed	B-1
Initial Setup Data	B-2

Table of Contents (cont.)

Appendix C: Programming with PanaView

Introduction	C-1
Wiring the RS232 Interface	C-1
Setting Up the Communications Port.....	C-2
Setting up Ethernet Communications.....	C-4
Adding the GF868.....	C-5
Editing Meter Properties	C-7
Setting the Meter Clock.....	C-9
Reading Transducer Signals	C-10
Plotting Transducer Signals.....	C-11
Saving Transducer Signals.....	C-11
Clearing Totalizers.....	C-11
Handling Site Files.....	C-12
Changing Meter Settings	C-15

Appendix D: Foundation Fieldbus Communications

Optional Measurements	D-1
Configuration Utility Setup.....	D-2
Selecting the Desired Measurements.....	D-2
Selecting Units for AI Blocks	D-4
Resetting Instrument Totalizers.....	D-5
Function Block Application.....	D-6

Chapter 1

Programming Site Data

- Introduction..... 1-1
- Using the Keypad..... 1-2
- Obtaining On-line Help..... 1-6
- Using the Console Control Keys..... 1-7
- The User Program..... 1-8
- Activating the Channel..... 1-9
- Entering System Data..... 1-10
- Entering Pipe Data..... 1-12
- Setting Up Inputs/Outputs..... 1-15
- Entering Setup Data..... 1-23
- Setting the Clock..... 1-32
- Setting Up Serial Communications..... 1-34
- Saving Site Data..... 1-39
- Recalling a Site..... 1-40
- Activating Security..... 1-41

Introduction

The Model GF868 flowmeter cannot provide accurate flow rate measurements until the instrument has been properly installed and the basic system and pipe parameters have been programmed into the meter. See the *Startup Guide* for detailed instructions on performing these tasks. After completing the installation and initial setup, use this chapter to program the Model GF868's advanced features.

IMPORTANT: *If you are using PanaView™ software to program the GF868, refer to Appendix C.*

Ten submenus within the *User Program* provide access to the various programmable features of the Model GF868. Step-by-step programming instructions are presented in this chapter. Refer to the appropriate section for a discussion of the following *User Program* submenus:

- ACTIV - select the desired measurement method
- SYSTM - enter the system data
- PIPE - enter the pipe parameters
- I/O - set up the inputs and outputs
- SETUP - set the signal limits and response times
- CLOCK - set the time and date
- COMM - set the serial port parameters
- SAVE - save site files
- RECLL - recall stored site files
- SECUR - enter a passcode

As an aid in following the programming instructions, a complete menu map of the *User Program* is included in Appendix A, *Menu Maps*.

Note: *In the menu map drawings, plain text represents prompt area messages and boxed text represents option bar choices. Fx represents a function key to select an option bar choice.*

Using the Keypad

The Model GF868 keypad contains 39 keys, that are labeled with their primary (unshifted) functions. In addition, pressing the red [SHIFT] key will access the secondary functions assigned to most of the keys.

The complete keypad is illustrated in Figure 1-1 below and a detailed description of both the unshifted and shifted functions for each of the 39 keys is listed in Table 1-1 on page 1-3.

Note: *Only the [SHIFT] key and the eight [F x] keys have no shifted function.*

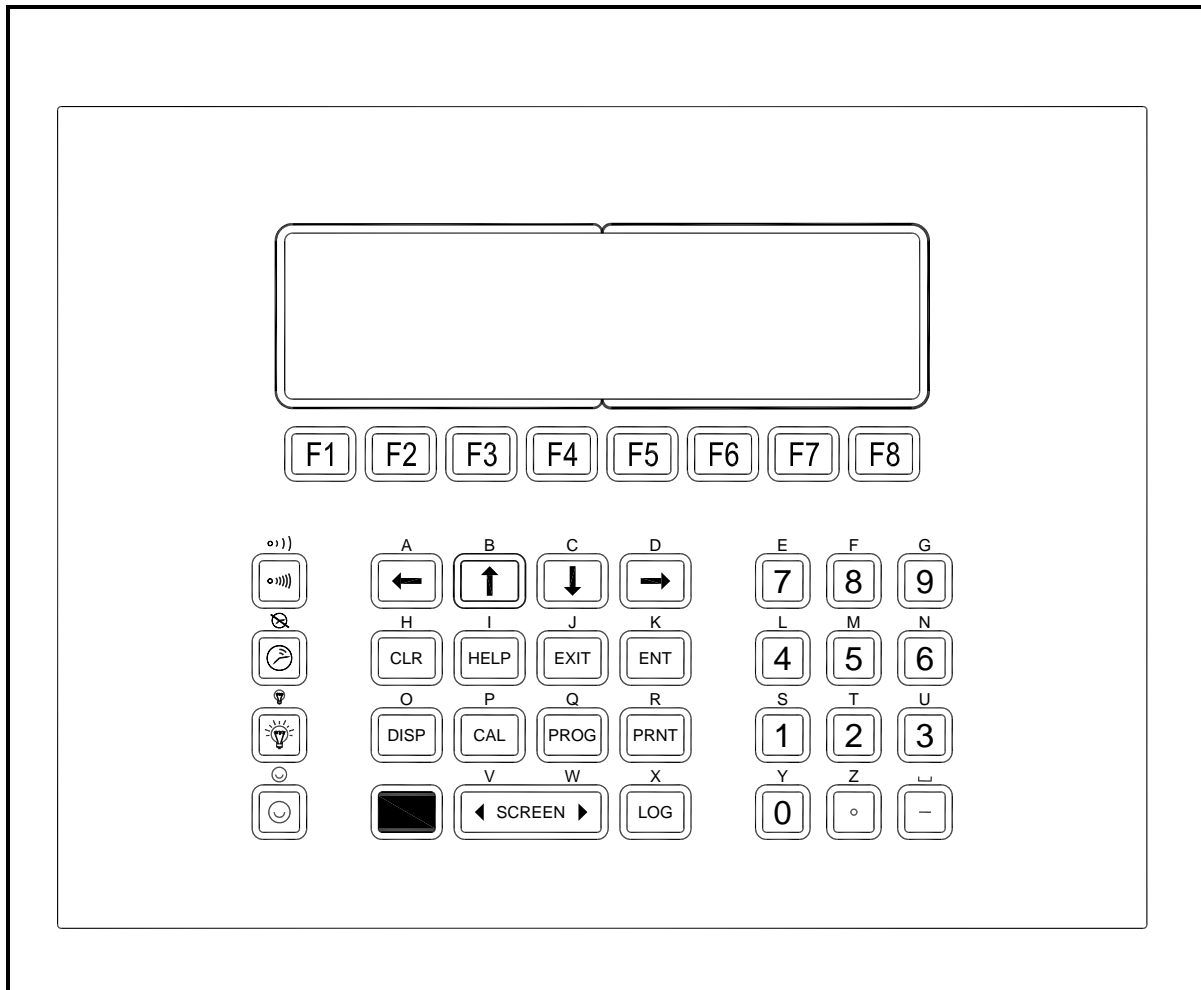

Figure 1-1: The Model GF868 Keypad

Note: *Although the keypad is essentially the same, the front panel layout of meters supplied in one of the optional enclosures is different. See Appendix C, Optional Enclosures, of the Startup Guide for a picture of the applicable front panel.*

Table 1-1: Model GF868 Key Functions















Key	Unshifted Function	Shifted Function
	Software Function Keys - press to select the functions displayed directly above them in the option bar. These keys apply only to the left pane of the display screen.	None
		
		
		
	Software Function Keys - press to select the functions displayed directly above them in the option bar. These keys apply only to the right pane of the display screen.	None
		
		
		
	Shift Key - use this red key to access the shifted function of the other keys. One press shifts the next keystroke only, while two presses locks the keypad in shifted mode. A third press releases the shift function.	None
	Arrow Keys - in measurement mode, use to scroll through function choices on the option bar. In programming mode, use to scroll through menu choices. The [←] also acts as a back-space key in programming mode.	Use to enter the letters A, B, C and D, respectively.
		
		
		
	Program Key - press to enter the <i>User Program</i> . See page 1-8 for details.	Use to enter the letter Q.

Table 1-1: Model GF868 Key Functions (cont.)



















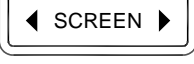





Key	Unshifted Function	Shifted Function
	Display Key - use to display data in a variety of numeric and graphic formatting options. See page 2-1 for details.	Use to enter the letter O.
	Log Key - use to set up logs. See page 3-1 for details.	Use to enter the letter X.
	Print Key - use to print live measurements, log files and signal arrays. See page 4-1 for details.	Use to enter the letter R.
	Clear Key - use to reset totals and to delete site and log files from the Model GF868 memory. See page 5-1 for details.	Use to enter the letter H.
	Calibration Key - use to calibrate the analog inputs and outputs and to test the alarm relays and the totalizer/frequency outputs. See Chapter 1, <i>Calibration</i> , of the <i>Service Manual</i> for details.	Use to enter the letter P.
	Exit Key - use to move up one level in the user program or to exit the user program. See this chapter for details.	Use to enter the letter J.
	Enter Key - use to confirm the most recent input information.	Use to enter the letter K.
	Help Key - use to access the Model GF868's context-sensitive on-line help system. See the next section for details.	Use to enter the letter I.
	Screen Key - press the left side to select the left display pane or press the right side to select the right display pane.	Press the left side to enter the letter V or press the right side to enter the letter W.
	Decimal Point Key - press to enter a decimal point during numeric entry.	Use to enter the letter Z.
	Minus Key - use to enter a minus sign or a dash.	Use to enter a space character.
	Zero Key - use to enter the number 0.	Use to enter the letter Y.
	One Key - use to enter the number 1.	Use to enter the letter S.

Table 1-1: Model GF868 Key Functions (cont.)

Key	Unshifted Function	Shifted Function
	Two Key - use to enter the number 2.	Use to enter the letter T.
	Three Key - use to enter the number 3.	Use to enter the letter U.
	Four Key - use to enter the number 4.	Use to enter the letter L.
	Five Key - use to enter the number 5.	Use to enter the letter M.
	Six Key - use to enter the number 6.	Use to enter the letter N.
	Seven Key - use to enter the number 7.	Use to enter the letter E.
	Eight Key - use to enter the number 8.	Use to enter the letter F.
	Nine Key - use to enter the number 9.	Use to enter the letter G.
	Audio Level Key - press to increase the audio alarm volume.	Press to decrease the audio alarm volume.
	Stopwatch Timer Key - press to turn the stopwatch timer on.	Press to turn the stopwatch timer off.
	Backlight Key - press to turn the display backlight on or to increase its brightness.	Press to turn the display backlight off or to decrease its brightness.
	Contrast Key - press to increase the contrast of the display screen.	Press to decrease the contrast of the display screen.

Obtaining On-line Help

A context-sensitive, on-line help system is programmed into every Model GF868 flowmeter. On-line help, which displays additional information related to the current task, may be accessed at any time by pressing the [HELP] key on the keypad. The help information will be shown on the currently selected pane of the display screen, as shown in Figure 1-2 below.

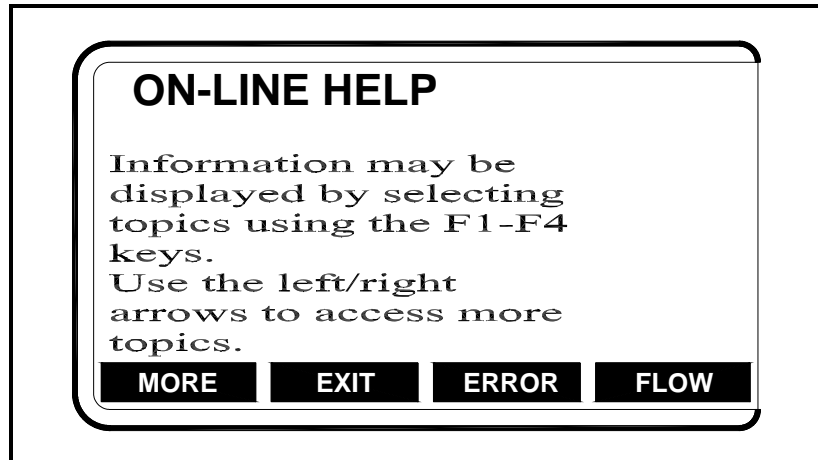

Figure 1-2: Typical On-Line Help Screen

After entering the on-line help system, the following functions are available on the option bar of the selected display pane:

- MORE: Press [F1] (or [F5]) to access this function, and the next screen of text is displayed in the prompt area.
- EXIT: Press [F2] (or [F6]) to access this function, and the Model GF868 returns to measurement mode.
- ERROR: Press [F3] (or [F7]) to access this function, and the various Model GF868 error codes are displayed. Use the [F1]-[F4] (or [F5]-[F8]) function keys, in conjunction with the [←] and [→] keys, to obtain additional information on the desired error code or to exit the help system.

Note: See the Service Manual for a complete listing of all error codes and messages

- FLOW: Press [F4] (or [F8]) to access this function, and the various flow measurement parameters are displayed. Use the [F1]-[F4] (or [F5]-[F8]) function keys, in conjunction with the [←] and [→] keys, to obtain additional information on the desired measurement parameter or to exit the help system.

Using the Console Control Keys

The Model GF868 has four console control keys, which are located on the left side of the keypad. Use these keys, which are described and pictured in Table 1-1 on page 1-3, as follows:

Audio Alarm Volume

Use the top console control key to adjust the audio alarm volume.



Discrete presses will incrementally increase the volume of the audio alarm. Hold the key down for continuous increase. Use the key in shifted mode to decrease the volume of the audio alarm.

Stopwatch Totalizer

Use the second console control key for the stopwatch totalizer.



Press the key once to start the stopwatch totalizer. Press the key once, in shifted mode, to stop the stopwatch totalizer.

Note: *Instructions on properly setting up the stopwatch totalizer are given later in this chapter. Also, the Service Manual provides information on the error response of the stopwatch totalizer.*

Display Brightness

Use the third console control key to adjust the display backlight.



Discrete presses of this key will increase the backlight brightness through settings of Off, Mid and Full. Discrete presses of this key in shifted mode, will decrease the backlight brightness through settings of Full, Mid and Off.

Note: *The display backlight has an automatic time-off feature. See page 2-14 for setup instructions.*

Display Contrast

Use the bottom console key to adjust the display contrast.



Discrete presses will incrementally increase the display contrast. Hold the key down for continuous increase. Use the same key, in shifted mode, to decrease display contrast.

Entering Programming Mode

Use the keypad, as described in the previous section, to navigate through the *User Program*. The menu map may be followed in sequence, or the [↑] and [↓] keys may be used to scroll through the prompt screens. The [←] key may be used to delete the last alphanumeric character that was entered from the keypad.

The following discussion assumes that the left screen pane is active. If the right screen pane is active, only the function key designations change. That is, replace [F1]-[F4] with [F5]-[F8].

Note: *Be sure to record all the programming data entered in this chapter in Appendix B, Data Records.*

Programming of the ACTIV, SYSTM and PIPE submenus is necessary for operation of the Model GF868. Failure to accurately enter all of the required information will result in unreliable flow rate data. Therefore, be sure to complete at least the sections of this chapter pertaining to those three submenus.

Note: *Because it is so essential, instructions for programming the ACTIV, SYSTM and PIPE submenus are also included in the Startup Guide. If that programming has already been completed, those sections of this chapter may be skipped.*

Except for the three submenus noted above, it is not necessary to program the Model GF868 flowmeter in any particular order. Therefore, the sections of this chapter need not be completed in sequence. Proceed immediately to any section of interest.

To access the *User Program*, press the [PROG] key on the keypad. The standard measurement mode screen is replaced by the following initial programming mode screen:

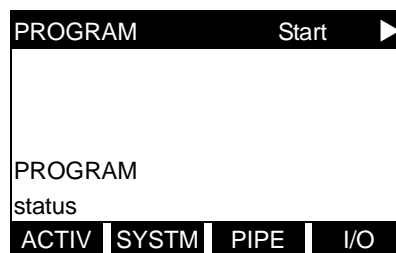

Press the [←] and [→] keys and one of the function keys [F1]-[F4] to select the desired submenu. From this screen, press [EXIT] to return to measurement mode.

Note: *If the security feature is active, enter the password and press the [ENT] key to enter the User Program. See the SECUR submenu section of this chapter for more information on the security feature.*

Activating the Channel

The ACTIV submenu permits selection of the desired measurement method. While following the programming instructions, refer to Figure A-1 on page A-1.

1. Enter the ACTIV submenu by pressing [F1] at the User PROGRAM prompt.
2. Press [F1] to activate the channel in BURST mode.

Note: *The current status of the meter is displayed in the bottom line of the prompt area.*

3. Press [F1] to select *Skán* mode or [F2] to select *Skán/Measure* mode. The meter will exit the ACTIV submenu and return to the channel menu screen.

The Model GF868 flowmeter can take measurements in two different ways:

- **Skán** is a low resolution technique for locating the acoustic signal and for high velocity measurements. It is more robust in a noisy environment than the Measure technique.
- **Measure** is a more precise technique best used for low velocity measurements.

If *Skán* is selected at the next prompt, the instrument uses this technique exclusively. However, if *S/M* is selected, the meter uses *Skán* to find the acoustic signal and then tries to use the *Measure* technique for a more precise measurement.

Note: *To change the Skán and Measure parameters, see the SIGNAL submenu section of this chapter.*

Procedure Options

After completing the above steps, the meter returns to the User PROGRAM prompt. Continue as follows:

- To continue programming the meter, refer to the menu maps in Appendix A and navigate to the desired menu. Then, proceed to the appropriate section of the manual for instructions.
- To leave the *User Program* and retain the previous settings, press [EXIT] and then press [F1] = NO at the SAVE prompt. Any programming changes will be discarded and you will be returned to the data display.
- To leave the *User Program* and return to measurement mode, press [EXIT] and then press [F2] = YES at the SAVE prompt. Your programming changes will be entered into the meter's memory, and you will be returned to the data display.

Entering System Data

1. At the *User Program* screen, press the [F2] function key to program the SYSTM submenu.
2. Enter a *Site Label* of up to 9 characters and press [ENT]. (While taking measurements, the site label will appear on the locator bar.)
3. Enter a *Site Message* of up to 21 characters. Press [ENT].

Entering System Units

4. To select the *System Units*, press [F1] to display parameters and measurements in English units, or press [F2] to display parameters and measurements in Metric units.
5. Use the [F1]-[F4] keys to select the type of *Pressure Units* desired. The available pressure units are shown in Figure A-1 on page A-1. The choices shown on the option bar are determined by the selections made at the previous SYSTEM UNITS prompt.
 - a. If you have entered gage pressure, or the local atmospheric pressure (PSIg, BARg or kPag), use the numeric keys to enter the gage pressure value. Press [ENT].
6. At the *Stopwatch Totalizer* prompt, press [F1] to totalize all liquid flow continuously, or [F2] to measure totals manually with the Stopwatch Timer. (With MNUAL ([F2]), the console key on the keypad is used to start and stop the totalizer. See page 1-7 for details.)

IMPORTANT: *After setting up the Stopwatch Totalizer, press [CLR] to clear the Stopwatch Totalizer, or the new totals will be added to any previously accumulated totals.*

Note: *The manner in which the Stopwatch Totalizer responds to an error condition may be set in the I/O submenu.*

Entering Volumetric Data

7. Use the [F1]-[F4] and [→] keys to select the desired *Volumetric Units* for the flow rate display. The available volumetric and totalizer units are shown in Figure A-1 on page A-1.
8. Use the [F1]-[F4] keys to select the *Volumetric Time* (units for the volumetric flow rate display).
9. Use the [F1]-[F4] keys to select the *Vol Decimal Digits* (the desired number of digits to the right of the decimal point) in the volumetric flow rate display.

- Entering Totalizer Data
10. Use the [F1]-[F4] and [→] keys to select the *Totalizer Units*.
 11. Use the [F1]-[F4] keys to select the *Total Decimal Digits* (the desired number of digits to the right of the decimal point) in the totalized flow display.
- Entering Mass Flow Data.
12. Use the [F1]-[F4] keys to select the *Mass Flow* units, listed in Figure A-1 on page A-1.
 13. Use the [F1]-[F4] keys to select the *Mass Flow Time* units.
 14. Use the [F1]-[F4] keys to select the *MDOT Decimal Digits* (the number of digits to the right of the decimal point) for displaying mass flow.
 15. Use the [F1]-[F4] keys to select the *Mass (Totalizer)* units.
 16. Use the [F1]-[F4] to specify the *Mass Decimal Digits* (the number of digits to the right of the decimal point) for displaying totalized mass flow. The meter returns to the initial *User Program* screen.

Procedure Options

After completing the above steps, the meter returns to the User PROGRAM prompt. Continue as follows:

- To continue programming the meter, refer to the menu maps in Appendix A and navigate to the desired menu. Then, proceed to the appropriate section of the manual for instructions.
- To leave the *User Program* and retain the previous settings, press [EXIT] and then press [F1] = NO at the SAVE prompt. Any programming changes will be discarded and you will be returned to the data display.
- To leave the *User Program* and return to measurement mode, press [EXIT] and then press [F2] = YES at the SAVE prompt. Your programming changes will be entered into the meter's memory, and you will be returned to the data display.

Entering Pipe Data

Enter the transducer and pipe parameters using the PIPE submenu. While following the programming instructions, refer to Figure A-1 on page A-1. To program this menu, complete the following steps:

1. At the *User* (or *Channel*) *Program* screen, press [F3] to program the PIPE submenu.
2. Enter the *Transducer Number* (normally engraved on the head of the transducer). Press [ENT]. If there is no engraved number, complete the steps below. Otherwise, proceed to step 3.

IMPORTANT: *Special transducers, which have no engraved number on the head, are rarely used. Examine the transducer head carefully for a number.*

Special Transducers

- a. Assign a number between 91 and 99 to the *Special Transducer* and press [ENT]. (The meter will only accept values from 1 to 199.)
- b. Use the [→] and [F1]-[F4] keys to select the *Frequency* of the special transducer. The meter can not transmit an excitation voltage at the transducer's natural frequency without this data.
- c. Enter the special transducer *Time Delay (Tw)* value supplied by the factory. Press [ENT]. (The meter will only accept values from 0 to 1000 μ sec.)

Note: *Tw is the time required for the transducer signal to travel through the transducer and its cable. This time delay must be subtracted from the transit times of the upstream and downstream transducers to ensure an accurate measurement.*

Pipe OD

3. Enter the known *Pipe OD* or circumference and use the [F1]-[F4] keys to select the appropriate units. Press [ENT]. (The meter will only accept values from 1/8 to 648 in.) The option bar choices, listed in Figure A-1 on page A-1, may appear in English or Metric units. Obtain the required information by measuring either the pipe outside diameter (OD) or circumference at the transducer installation site. The data may also be obtained from standard pipe size tables.

Pipe Wall

4. Use the numeric keys to enter the known thickness of the *Pipe Wall*. Press [ENT].

IMPORTANT: *Because the units cannot be independently chosen for this parameter, the value must be entered in the same units used for the pipe OD.*

If the pipe wall thickness is not available, look up the value in a table of standard pipe size data or use the Model GF868's on-line *Help Menu* (see the *Programming Manual* for details).

Path Length

5. Press [F1] = inch or [F2] = feet to select the units. Then, enter the *Path Length (P)* of the ultrasonic signal. Press [ENT]. (The meter will only accept values from 1/8 to 900 in.)

Note: *The factory has calculated both the transducer signal path length (P) and the transducer signal axial length (L), based on the exact transducer configuration used for the application. These values are engraved on the flowcell and/or are included in the documentation supplied with the meter.*

Axial Length

6. Press [F1] = inch or [F2] = feet to select the units. Then, enter the *Axial Length (L)* of the ultrasonic signal and press [ENT].

Note: *The factory has calculated both the transducer signal path length (P) and the transducer signal axial length (L), based on the exact transducer configuration used for the application. These values are engraved on the flowcell and/or are included in the documentation supplied with the meter.*

Reynolds Correction

7. Press [F1] to turn *Reynolds Correction* off, or [F2] to turn it on.

Note: *Reynolds Correction is a number based on the Kinematic Viscosity and flow rate of the fluid. It should be enabled for most applications.*

- a. When you enable the Reynolds Correction Factor, you must also enter the *Kinematic Viscosity* of your gas, as listed in *Sound Speeds and Pipe Size Data*. Use the numeric keys to enter a value, and press [ENT].

Calibration Factor

8. Enter a value for the flow *Calibration Factor* and press [ENT]. The default value is 1.00. (The meter will only accept values between 0.50 and 2.00.)

Procedure Options

After completing the above steps, the meter returns to the User PROGRAM prompt. Continue as follows:

- To continue programming the meter, refer to the menu maps in Appendix A and navigate to the desired menu. Then, proceed to the appropriate section of the manual for instructions.
- To leave the *User Program* and retain the previous settings, press [EXIT] and then press [F1] = NO at the SAVE prompt. Any programming changes will be discarded and you will be returned to the data display.
- To leave the *User Program* and return to measurement mode, press [EXIT] and then press [F2] = YES at the SAVE prompt. Your programming changes will be entered into the meter's memory, and you will be returned to the data display.

Setting Up Inputs/ Outputs

Set up the GF868's inputs and outputs using the four options in the I/O submenu. While following the programming instructions, refer to Figure A-2 on page A-2.

- ERROR - program the meter's response during an error condition
- OPTN - set up the Slot 0 analog outputs and any option cards
- ZERO - set the meter's zero point cutoff value
- T,P - set up the temperature and pressure inputs

Enter the I/O submenu by pressing [F4] at the initial *User Program* screen. Then press [F1]-[F4] to select the desired I/O option.

Note: *In this section, a slot's number will appear on the option bar only if an option card is installed in that slot. The generic designations Slot x and Fx are used to indicate any one of the expansion slots and the function key used to select it.*

Proceed to the appropriate section to program the option selection made at the above prompt. Remember to record all programmed data in Appendix B, *Data Records*.

Selecting Error Handling

This menu option permits programming of the manner in which the Model GF868's totalizers respond during an error condition. See Chapter 2, *Error Codes and Screen Messages*, of the *Service Manual* for a discussion of the built-in error codes.

1. At the I/O prompt, press [F1] = Error.
2. Press [F1] if you want the GF868 to *Hold* the last "good" reading and continues to totalize, based on that reading, or press [F2], *No Up*, if you want the meter to stop totalizing.

Setting Up Analog Outputs The Model GF868 has two built-in analog outputs, which are assigned to Slot 0. Also, a variety of option cards may be installed in the six expansion slots. See Chapter 1, *Installation*, of the *Startup Guide* for a complete description of the available option cards.

This menu option is used to set up and/or scale the analog inputs and outputs. To accomplish this, complete the following steps:

1. Use the [←] and [→] and the [F1]-[F4] keys to select the desired slot number. (Only those slots which contain an option card will appear on the option bar.)

Note: *If the number of a slot with an installed option card does not appear, the card may not have been initialized or it may be defective. Call the factory for assistance.*

Complete the following steps to set up the Slot \times analog outputs:

1. Use the [F1]-[F4] keys to set up outputs A, B, C or D, respectively.

Note: *The set up of output A is used as an example. Identical procedures would be used to set up the other outputs.*

2. Press [F1] = OFF to disable output A and return to the previous prompt, or press [F2] = 0-20 m or [F3] = 4-20 m to specify the desired range for output A.
3. Use the [←] and [→] and [F1]-[F4] keys to specify the desired *Output Measurement* parameter (see Figure A-1 on page A-1).
4. Enter the *Zero* value for the low end of the chosen output range. Press [ENT].
5. Enter the *Full* value for the high end of the chosen output range. Press [ENT].
6. Use the [F1]-[F4] keys to set up another output or press [EXIT] to select another slot for setup.

For instructions on setting up additional inputs and/or outputs proceed to the appropriate section. Otherwise, press [EXIT] to return to the main I/O menu prompt.

Option Card Alarms

1. Use the [←] and [→] and the [F1]-[F4] keys to select the desired slot number.
2. Use the [F1]-[F3] keys to set up alarm relays A, B, or C, respectively.

Note: *The set up of alarm A is used as an example. Identical procedures would be used to set up the other alarms.*

3. Press [F1] = OFF to disable Alarm A and return to the previous prompt, or press [F2] = HIGH, [F3] = LOW or [F4] = FAULT to specify the type for Alarm A.
4. Press [F1] = NO for standard operation or [F2] = YES for *Failsafe* operation.
5. Do one of the following:
 - If you selected FAULT, proceed to step 6.
 - If you selected HIGH or LOW, complete the steps below.
 - a. Use the [←] and [→] and [F1]-[F4] keys to specify the desired *Output Measurement* parameter, as shown in Figure A-2 on page A-2.
 - b. Enter a value for the trigger point of the alarm and press [ENT].
6. To select the Fault Type that will trigger the alarm, press F1 = FLOW, F2 = OTHER (non-flow), or F3 = ALL.
7. Press [F1]-[F3] to set up another alarm or press [EXIT] to select another slot for set up.

For instructions on setting up additional inputs and/or outputs proceed to the appropriate section. Otherwise, press [EXIT] to return to the main I/O menu prompt.

Setting Up the Totalizer/ Frequency Outputs

1. Press [F1]-[F4] to set up outputs A, B, C or D, respectively.
2. Press [F1] = OFF to disable output A and return to the previous prompt, or press [F2] = FREQ or [F3] = TTLZR to designate output A as a frequency or a totalizer output, respectively.

Note: *The setup of output A is used as an example. Identical procedures would be used to set up the other outputs.*

- To program a frequency output, go to step 3.
- To program a totalizer output, go to step 4.

Programming a Frequency Output

3. The FREQ output, [F2], produces a frequency pulse that is proportional to the output measurement. Complete the steps below to program the frequency output.
 - a. Use the [←] and [→] and [F1]-[F4] keys to specify the desired *Output Measurement* parameter.
 - b. Enter the *Base* value for the low end of the frequency output range and press [ENT].
 - c. Enter the *Full* value for the high end of the frequency output range. Press [ENT].
 - d. Enter a value between 1 and 10,000 for the *Full Scale Frequency*. Press [ENT].

Programming a Totalizer Output

4. The TTLZR output, [F3], issues one pulse per selected volume of flow. The meter produces a pulse each time the programmed amount of flow passes through the pipe. Complete the steps below to program the totalizer output.
 - a. Press [F1] = +TOTL to totalize the forward flow, [F2] = -TOTL to totalize the reverse flow, [F3] = +MASS (if available) to totalize the forward mass flow or [F4] = -MASS (if available) to totalize reverse mass flow.
 - b. Enter a value from 50 to 500,000 μ sec for the *Minimum Pulse ON Time* and press [ENT].

Note: *A complete pulse consists of equal amounts of ON and OFF times. Choose a value that is compatible with the frequency counter to be used.*

- c. Enter a value for the number of measurement *Units/Pulse* and press [ENT].
5. Press [F1]-[F4] to set up another totalizer/frequency output or press [EXIT] to select another slot for setup.

Setting up the Analog Inputs

1. Press [F1] to set up input A or [F2] to set up input B.
Note: *The set up of input A is used as an example in this manual. Identical procedures would be used to set up input B. (An analog input option card may contain one standard analog input and one RTD analog input.)*
2. Enter a *Label* of up to eight characters for input A and press [ENT].
3. At the *Input Measurement* prompt, press [F1] = OFF to disable input A and return to the previous prompt, or press [F2] = PRESR (pressure), [F3]= TEMP (temperature) or [F4] = SPEC (special) to designate the input.
4. Do one of the following:
 - If you selected PRESR or TEMP, proceed to step 5.
 - If you selected SPEC, complete the steps below.
 - a. Enter an *Input Name* and press [ENT].
 - b. Enter the *Input Units* of measurement and press [ENT].
5. Enter the *Zero Value* for the low end of the chosen input range and press [ENT].
6. Enter the *Full Scale Value* for the high end of the chosen input range and press [ENT].
7. Press [F1]-[F2] to set up another input or press [EXIT] to select another slot for setup.

For instructions on setting up additional inputs and/or outputs proceed to the appropriate section. Otherwise, press [EXIT] to return to the main I/O menu prompt.

Setting up RTD Inputs

Option cards with RTD inputs have a temperature range of -100° to 350°C . Complete the following steps to set up the two RTD inputs of an option card installed in Slot x:

1. Press [F1] to set up RTD input A or [F2] to set up RTD input B.

Note: *The setup of RTD input A is used as an example. Identical procedures would be used to set up RTD input B.*

2. Enter a label of up to eight characters and press [ENT].
3. At the *Input Measurement* prompt, press [F1] = OFF to disable RTD input A and return to the previous prompt, or press [F2] = TEMP to enable RTD input A.
4. Enter the *Zero Value* for the low end of the chosen input range and press [ENT].
5. Enter the *Full Scale Value* for the high end of the chosen input range and press [ENT].
6. Press [F1]-[F2] to set up another input or press [EXIT] to select another slot for set up.

For instructions on setting up additional inputs and/or outputs proceed to the appropriate section. Otherwise, press [EXIT] to return to the main I/O menu prompt.

Entering the Zero Cutoff

Near zero flow, the Model GF868's readings may fluctuate due to small offsets caused by thermal drift or similar factors. To force a zero reading when there is minimal flow, enter a zero cutoff value as described below:

1. At the main I/O menu prompt, press [F3] = ZERO.
2. Enter the desired *Zero Cutoff* value and press the [ENT] key. A value of 0.1 ft/s (0.03 m/s) is recommended, but values from 0–1 ft/s (0–0.3 m/s) are acceptable. The menu returns to the main I/O prompt.

Setting Up Temperature and Pressure Inputs

The Model GF868 can use either fixed temperature and pressure quality values or live measurement inputs to calculate standard volumetric or mass flow. Complete the following steps to configure these inputs:

1. At the main I/O menu prompt, press [F4] =T,P.

Entering the Temperature Input

2. At the *Temperature Input* prompt, press [F1] to enter a constant temperature value or press [F \times] to select the option card in Slot \times that will supply the live temperature input.

Note: *Each slot that contains an option card with an analog input assigned to TEMP or an RTD input will appear on the option bar. If the process temperature is stable, a fixed value may be used, but most applications require a live temperature input.*

3. Do one of the following:

- If you selected FIXED, enter the known fixed process temperature. Press [ENT]. (The meter will only accept values from -148° to 662° F.)
- If you selected SLOT X,
 - a. Press [F1] to select input A or press [F2] to select input B. The inputs were labeled during setup.

Note: *The set up of input A is used as an example. Identical procedures would be used to set up input B.*

- b. Enter the *Base Temperature* (from -148° to 662° F), and press [ENT]. The ratio of this value to the actual temperature is used to calculate the standard volumetric flow.

Entering the Pressure Input

4. At the *Pressure Input* prompt, press [F1] to enter a constant pressure value or press [F \times] to select the option card in Slot X that will supply the live pressure input.

Note: *Each slot that contains an option card with an analog input assigned to PRESR will appear on the option bar. If the process pressure is stable, a fixed value may be used, but most applications require a live pressure input.*

5. Do one of the following:

- If you selected FIXED, enter the known fixed process pressure. Press [ENT]. (The meter will only accept values from 0–5000 psia.)

Entering the Pressure Input (cont.)

- If you selected SLOT X,
 - a. Press [F1] to select input A or press [F2] to select input B. The inputs were labeled during setup.
 - b. Enter the *Base Pressure* (standard) value for the process, and press the [ENT] key. (The meter will only accept values from 0–5000 psia. In this parameter, it does not accept psig values.)

Note: *If an installed option card does not appear on the option bar for the TEMPERATURE INPUT or PRESSURE INPUT, the card may not have been initialized or it may be defective. Call the factory for assistance.*

6. At the *N2 Input* prompt, press [F1] to enter a constant N₂ percentage or press [Fx] to select the option card in Slot x that will supply the live N₂ percentage.
7. Do one of the following:
 - If you selected FIXED, enter the known fixed N₂ percentage. Press [ENT]. (The meter will accept values from 0 to 100 percent.)
 - If you selected SLOT X,
 - a. Press [F1] to select input A or press [F2] to select input B. The inputs were labeled during setup.

Procedure Options

After completing the above steps, the meter returns to the main I/O prompt. Continue as follows:

- To continue programming the meter, press [EXIT] to return to the *User Program*. Refer to the menu maps in Appendix A and navigate to the desired menu. Then, proceed to the appropriate section of the manual for instructions.
- To leave the *User Program* and retain the previous settings, press [EXIT] and then press [F1] = NO at the SAVE prompt. Any programming changes will be discarded and you will be returned to the data display.
- To leave the *User Program* and return to measurement mode, press [EXIT] and then press [F2] = YES at the SAVE prompt. Your programming changes will be entered into the meter's memory, and you will be returned to the data display.

Entering Setup Data

The signal limits and response times for the Model GF868 are specified using the SETUP submenu. While following the programming instructions, refer to Figure A-3 on page A-3. The following four submenus are included in this section:

- SIGNAL - set the parameters related to the transducer signal
- AVRG - specify the response of the meter to step changes
- INIT - initialize some parameters to default values.
- ADVAN - enter mass flow and K-factor data.

Enter the SETUP submenu by pressing [→] and [F1] at the initial *User Program* screen and complete the following steps:

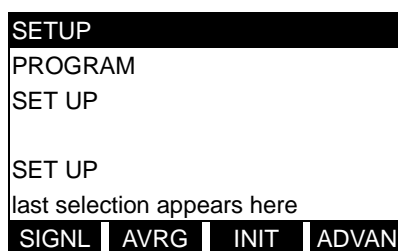

Press [F1]-[F4] to select the desired SETUP option.

Proceed to the appropriate section to program the option selection made at the above prompt. Remember to record all programmed data in Appendix B, *Data Records*.

Setting Transducer Signal Limits

Use this option to set the limits for the incoming signal and other parameters affecting the transducer signal. For example, the programmed signal strength low limit may be used to determine the trigger point for an alarm.

Caution!

The SIGNAL default settings are suitable for most applications. Before changing any of these parameters, consult the factory.

Complete the following steps to enter the signal parameters:

1. To enter the SIGNAL submenu, press [F1] at the SETUP window.
2. Press [ENT] to accept the current *Signal Low Limit* value or enter a new value and press [ENT].

The default value for this parameter is 20 and values from -20 to 100 are acceptable. The E1: LOW SIGNAL error message appears when the signal strength falls below the programmed SIGNAL LOW LIMIT value. See the *Service Manual* for a discussion of error codes.

Setting Signal Limits
(cont.)

3. Press [ENT] to accept the current *Cor. Peak Limit* value or enter a new value and press [ENT].

The default value for this parameter is 100 and values from 0 to 500 are acceptable. The E4: SIGNAL QUALITY error message appears when the signal quality falls below the programmed COR. PEAK LIMIT value. See the *Service Manual* for a discussion of error codes.

4. Press [ENT] to accept the current *Velocity Low Limit* value or enter a new value and press [ENT].

The default value for this parameter is -300.0 ft/sec (-85 m/sec) and values from -500 to 500 ft/sec (-150 to 150 m/sec) are acceptable. The E3: VELOCITY RANGE error message appears when the calculated fluid velocity is less than the programmed VELOCITY LOW LIMIT value. See the *Service Manual* for a discussion of error codes.

5. Press [ENT] to accept the current *Velocity High Limit* value or enter a new value and press [ENT].

The default value for this parameter is 300.0 ft/sec (85 m/sec) and values from -500 to 500 ft/sec (-150 to 150 m/sec) are acceptable. The E3: VELOCITY RANGE error message appears when the calculated fluid velocity exceeds the programmed VELOCITY HIGH LIMIT value. See the *Service Manual* for a discussion of error codes.

6. Press [ENT] to accept the current *Acceleration* value or enter a new value and press [ENT].

The default value for this parameter is 100.0 ft/sec² (30.48 m/sec²) and values from 0 to 250 ft/sec² (0 to 76 m/sec²) are acceptable. The E6: CYCLE SKIP error message appears when the calculated fluid velocity changes by more than the programmed ACCELERATION LIMIT value from one reading to the next. See the *Service Manual* for a discussion of error codes.

7. Press [ENT] to accept the current *Amp. Discrim Low* value or enter a new value and press [ENT].

IMPORTANT: *Consult the factory before performing this step.*

The amplitude discriminator measures the size of the transducer signal received by the Model GF868. The default value for this parameter is 14 and values from 0 to 100 are acceptable. The E5: AMPLITUDE error message appears when the amplitude discriminator falls below the programmed AMP. DISCRIM LOW value. See the *Service Manual* for a discussion of error codes.

Setting Transducer Signal Limits (cont.)

8. Press [ENT] to accept the current *Amp. Discrim High* value or enter a new value and press [ENT].

IMPORTANT: *Consult the factory before performing this step.*

The amplitude discriminator measures the size of the transducer signal received by the Model GF868. The default value for this parameter is 34 and values from 0 to 100 are acceptable. The E5: AMPLITUDE error message appears when the amplitude discriminator exceeds the programmed AMP. DISCRIM HIGH value. See the *Service Manual* for a discussion of error codes.

9. Press [ENT] to accept the current *Delta T Offset* value or enter a new value and press [ENT].

IMPORTANT: *Consult the factory before performing this step.*

An offset between the upstream and downstream transit times is specified at this prompt. The default value for this parameter is 0 μsec and values from -1000 to 1000 μsec are acceptable.

10. Press [ENT] to accept the current *Skat T Offset* value or enter a new value and press [ENT].

At this prompt, specify a time measurement offset that compensates for any shift resulting from cross-correlation. The default value for this parameter is 58 μsec and values from -500 to 500 μsec are acceptable.

Note: *If you enter a value of 0 for this command, you enable a special mode of operation, ACTIVE SKAN T-OFFSET, that dynamically calculates the offset.*

11. Press [ENT] to accept the current *% of Peak* value or enter a new value and press [ENT].

The percentage of peak used to calculate the transit times and Delta T is specified at this prompt. The default value for this parameter is 50% and values from 1 to 100% are acceptable.

12. Use the [→] and [F1]-[F4] keys to select one of the preset values for the *XMIT Sample Size* from the option bar.

IMPORTANT: *Consult the factory before performing this step.*

Both the upstream and downstream transducers transmit ultrasonic pulses in bursts, which consist of a series of transmit pulses. XMIT SAMPLE SIZE determines how many bursts are sent in one direction before sending in the other direction. The default value for this parameter is 8 and values of 2, 4, 8, 16 and 32 are acceptable.

Setting Transducer Signal Limits (cont.)

13. Press [ENT] to accept the current *M>S_Switch* value or enter a new value and press [ENT].

IMPORTANT: *Consult the factory before performing this step.*

If the burst mode is set to Skan/Measure (S/M), the meter switches from Skan to Measure Mode when Delta T is less than the *M>S_Switch* value. **DO NOT** change this value unless advised to do so by the factory. The default value for this parameter is 50 μ sec and values from 0 to 250 μ sec are acceptable.

14. Press [ENT] to accept the current *# shifts* value or enter a new value and press [ENT].

The number of shifts corresponds to the actual number of transmits per cycle (number of signals added together in one direction to produce an averaged signal for one interrogation of the fluid) and need only be changed if the environment is very noisy or the acoustic signal is weak. The default value for this parameter is 3 and values from 0 to 10 are acceptable.

15. Press [ENT] to accept the current *A Divisor* value or enter a new value and press [ENT].

A Divisor is used in the calculation of the Measure Mode integrated threshold level and is not normally changed. The default value for this parameter is 2.5 and values from 0.1 to 10 are acceptable.

16. Press [ENT] to accept the current *# Transmit Pulses* value or enter a new value and press [ENT].

IMPORTANT: *Consult the factory before performing this step.*

Transmit Pulses specifies the number of pulses in a burst. The default value for this parameter is 4 and values from 1 to 16 are acceptable. For difficult conditions (i.e., long paths, high velocity or high temperature), settings as high as 16 may be necessary.

17. Press [ENT] to accept the current *T Window (Cycles)* value or enter a new value and press [ENT].

IMPORTANT: *Consult the factory before performing this step.*

Normally, the Model GF868 calculates the size of the transmit window based on pipe size and fluid sound speed. However, for special diagnostic purposes, it may sometimes be necessary to reset the window size. The default value for this parameter is 0 and values from 0 to 1000 are acceptable.

Setting Transducer Signal
Limits (cont.)

18. Press [ENT] to accept the current *R WINDOW (cycles)* value or enter a new value and press [ENT].

IMPORTANT: *Consult the factory before performing this step.*

Normally, the Model GF868 calculates the size of the receive window based on pipe size and fluid sound speed. However, for special diagnostic purposes, it may sometimes be necessary to reset the window size. The default value for this parameter is 10 and values from 10 to 300 are acceptable.

Note: *If the T WINDOW prompt is set to 0, the R WINDOW prompt does not appear, and the GF868 uses a R WINDOW Width based on the expected arrival of the signal.*

After completing these steps, the program returns to the SETUP window. Table 1-2 on the next page lists the default values and limits for SETUP parameters.

Setting Signal Limits
(cont.)**Table 1-2: Default Values and Limits for SETUP Parameters**

Parameter	Default Value	Low Limit	High Limit
Signal Low Limit	20	-20	100
Cor. Peak Limit	100	0	500
Velocity Low Limit	-300.0 ft/sec (- 85 m/sec)	-500 ft/sec (-150 m/sec)	+500 ft/sec (+150 m/sec)
Velocity High Limit	300.0 ft/sec (85 m/sec)	-500 ft/sec (-150 m/sec)	+500 ft/sec (+150 m/sec)
Acceleration Limit	100 ft/sec ² (30.48 m/sec ²)	0	250 ft/sec ² (76 m/sec ²)
Amp. Discrim Low	14	0	100
Amp. Discrim High	34	0	100
Delta T Offset	0	-1,000 µsec	1,000 µsec
Skat T Offset	58 µsec	-500 µsec	500 µsec
% of Peak	50%	1%	100%
XMIT Sample Size	8	2	32
M>S Switch	50 µsec	0 µsec	250 µsec
# shifts	3	0	10
A Divisor	2.5	0.1	10
# Transmit Pulses	4	1	16
T Window	0	0	1,000
R Window	10	10	300

Setting Response Time

Use this option to specify the number of readings that occur before the meter will respond to a step change in flow rate. In general, the smaller the number of readings, the less steady the display will appear.

1. To enter the AVRГ submenu, press [F2] at the SETUP window.
2. Use the [→] and [F1]-[F4] keys to select the desired option. The available response time options are 1, 2, 5, 10, 30, 60 and STATS. For best results, select STATS (statistics), as this increases the response time under steady flow conditions while still allowing a rapid response to changes in flow rate.

The GF868 program returns to the SETUP window. Remember to record all programmed data in Appendix B, *Data Records*.

Initializing the System

Use this option to initialize (reset) many of the parameters within the SETUP menu to their default values. These parameters include: Signal Low Limit, Correlation Peak Limit, Velocity Low and High Limits, Acceleration Limit, Amplitude Discrimination Low, Amplitude Discrimination High, Delta T Offset, Skan T Offset, % of Peak and XMIT Sample Size. They do **not** include: M>S_Switch, # Shifts, A Divisor, # Transmit Pulses, T WINDOW and R WINDOW, which remain at their last programmed values.

1. To enter the INIT submenu, press [F3] at the SETUP window.
2. Press [F1] = NO to keep the current values or press [F2] = YES to reset all values to their default settings.

Setting Advanced Parameters

The ADVAN option enables you to access the more advanced features of the GF868. In this option you can perform two functions:

- enable mass flow (calculated for static fluid density)
- enter a table of K-factors (based on velocity or Reynolds number) that compensates for non-linear flow rates (see the next page)

To enter the ADVAN submenu, press [F4] at the SETUP window.

Static Density?

1. Press [F1] = MASS to enter the Mass Flow option.
2. At the *Static Density?* prompt, press [F1] = NO or [F2] = YES. If you press NO, the GF868 returns to the Advanced Features prompt.
3. If you press YES, enter the *Fluid Density* of the gas to be measured and press [ENT]. (The meter will only accept values from 0.00001-100 lb/ft³.)

The GF868 returns to the Advanced Features prompt.

Edit K Factors

1. Press [F2] = MULTK to enter the MultiK option.
2. Press [F1] = NO to disable or [F2] = YES to enable *Multiple K-factors*.
 - If you press NO, the GF868 returns to the Advanced Features prompt.
 - If you press YES, complete the steps below.
 - a. The GF868 asks for the type of K factor. Press [F1] to select CstV (Custom velocity) or [F2] to select CstR (Custom Reynolds number).
 - If you enable CstR, you must also enter the *Kinematic Viscosity* of your gas, as listed in *Sound Speeds and Pipe Size Data*. Use the numeric keys to enter a value, and press [ENT].
 - b. Press [F1] = NO to retain the current K-factor table and return to the Advanced Features prompt, or press [F2] = YES to *Edit The K-factor Table*.

Note: *If velocity vs. K-factor data was not provided with the Model GF868, the K-factor table can not be edited.*

- c. Enter the *Number of K-factors* to be entered into the table. Press [ENT]. (The meter will only accept values from 2 to 20.)
- IMPORTANT:** *When editing the K-factor table, the velocities must be entered in increasing order.*
- d. Enter the *Velocity (or Reynolds) Value* for K-factor number “x”. Press [ENT]. (The meter will only accept values from –30,000 to +30,000 ft/sec.)
 - e. Enter the *K-factor* corresponding to velocity number “x”. Press [ENT].
3. Repeat steps c and d until all of the data points have been entered.

Procedure Options

After completing the above steps, the meter returns to the Advanced Features prompt. Continue as follows:

- To continue programming the meter, refer to the menu maps in Appendix A and navigate to the desired menu. Then, proceed to the appropriate section of this manual for instructions.
- To leave the *User Program* and retain the previous settings, press [EXIT] twice and then press [F1] = NO at the SAVE prompt. Any programming changes will be discarded and you will be returned to the data display.
- To leave the *User Program* and return to measurement mode, press [EXIT] twice and then press [F2] = YES at the SAVE prompt. Your programming changes will be entered into the meter's memory, and you will be returned to the data display.

Setting the Clock

Use the CLOCK submenu to enter the current date and time. Refer to Figure A-3 on page A-3.

1. To program the CLOCK submenu, press [→] and [F2] at the initial *User Program*.

Setting the Date

2. The first prompt displays the programmed *Date*.
 - If the displayed date is correct, press [F1] = OK and proceed to step 2.
 - If the displayed date is incorrect, press [F2] = EDIT to change the date, and complete the steps below.
 - a. Enter the current *Year* and press [ENT]. The allowable range is 0 to 99.
 - b. Use the [←], [→] and [F1]-[F4] keys to select the current *Month*.
 - c. Enter the current *Day* and press [ENT]. The allowable range is 1 to the number of days in the current month.

Setting the Time

3. The next prompt displays the programmed *Time*.
 - If the displayed time is correct, press [F1] = OK to return to the *User Program*.
 - If the displayed time is incorrect, press [F2] = EDIT to change the time, and complete the steps below.
 - a. Press [F1] = AM or [F2] = PM. Then enter the current *Hour* and press [ENT]. The allowable range is 1 to 12.

Note: *A time of 12 PM represents Noon and a time of 12 AM represents Midnight.*

- b. Enter the current *Minutes* and press [ENT]. The allowable range is 0 to 59.
- c. Enter the current *Seconds* and press [ENT]. The allowable range is 0 to 59.

Procedure Options

After completing the above steps, the meter returns to the *User Program*. Continue as follows:

- To continue programming the meter, refer to the menu maps in Appendix A and navigate to the desired menu. Then, proceed to the appropriate section of this manual for instructions.
- To leave the *User Program* and retain the previous settings, press [EXIT] and then press [F1] = NO at the SAVE prompt. Any programming changes will be discarded and you will be returned to the data display.
- To leave the *User Program* and return to measurement mode, press [EXIT] and then press [F2] = YES at the SAVE prompt. Your programming changes will be entered into the meter's memory, and you will be returned to the data display.

Setting Up Serial Communications

The Model GF868 flowmeter can transmit stored data and displayed readings to a remote ANSI terminal or a personal computer by connecting the meter's RS232 interface to the serial port of the PC. In addition, the Model GF868 can receive and execute remote commands using this link. The meter can also be configured with a MODBUS option card for MODBUS communications, a Foundation Fieldbus option card for Foundation Fieldbus communications, an Ethernet option card for Ethernet communications, or with a MODBUS/TCP option card for MODBUS communication over the Ethernet, if desired.

Note: *To set Fieldbus communications parameters, see Appendix D, Foundation Fieldbus Communications.*

Use the COMM submenu to set the RS232, MODBUS, Ethernet and MODBUS/TCP communications port parameters and to enter a network identification number. A network identification number is required to use the GE *Instrument Data Manager* or *PanaView* software. While following the programming instructions, refer to the menu map in Figure A-3 on page A-3. Enter the COMM submenu by pressing [→] and [F3] at the initial *User Program* screen and complete the following steps:

1. Use the [←] and [→] and [F1]-[F4] keys to select the desired *Baud Rate*. The available rates are 300, 600, 1200, 2400, 4800, 9600 and 19,200 baud.
2. Use the [←] and [→] and [F1]-[F4] keys to select the number of *UART Bits*, as listed in Table 1-3 below.

Table 1-3: UART Bits Options

Option Bar	# Data Bits	# Stop Bits	Parity
8,no	8	0	None
8,odd	8	0	Odd
8even	8	0	Even
7,odd	7	1	Odd
7even	7	1	Even

3. Enter a *Network ID* number between 1 and 254 and press [ENT]. The default number is 1.

A network ID number is necessary only for communication with the GE *Instrument Data Manager*[™] or *PanaView*[™] software. See the software *User's Manual* for more information.

IMPORTANT: *If the network ID number is changed, communication with the Instrument Data Manager or PanaView must be re-established with the new ID number.*

MODBUS (RS485) Parameters

If your GF868 does not include an option card for MODBUS communications, you have completed programming the COMM submenu. However, if you have installed a MODBUS option card, the following additional prompts appear.

1. Press [F1]-[F4] to select the desired *MODBUS Baud Rate* from four selections: 2400, 4800, 9600 and 19,200.
2. Press [F1]-[F3] to set the *MODBUS Parity* as none, odd or even.
3. Press [F1] to select one *MODBUS Stop Bit*, or [F2] to select two stop bits.
4. Use the numeric keys to enter a *MODBUS Address* (from 1 to 247) and press [ENT].

Programming of the COMM submenu has now been completed. To leave the *User Program*, press [EXIT]. If changes have been made in any of the submenus, the following screen appears:

PROGRAM	Start
Do you want to SAVE current selection appears here	
No	Yes

At the *User Program* screen shown, press [F1] to return to measurement mode without saving the file or press [F2] to enter the SAVE submenu.

Note: See the *SAVE submenu* section on page 1-39 of this chapter for more information on this function.

MODBUS/TCP Parameters

If your GF868 does not include an option card for MODBUS/TCP communications, you have completed programming the COMM submenu. However, if you have installed a MODBUS/TCP option card, you must complete the following steps:

1. Press [F3] to select the appropriate *MODBUS Baud Rate* of 9600.
2. Press [F1]-[F3] to set the *MODBUS Parity* as none, odd or even.
3. Press [F1] to select one *MODBUS Stop Bit*, or [F2] to select two stop bits.
4. Use the numeric keys to enter a *MODBUS Address* (from 1 to 247) and press [ENT].

Programming of the COMM submenu has now been completed. To leave the *User Program*, press [EXIT]. If changes have been made in any of the submenus, the *SAVE* screen (shown above) appears. Press [F1] to return to measurement mode without saving the file or press [F2] to enter the *SAVE* submenu and save the file.

Procedure Options

After completing the above steps, the meter returns to the User Program. Continue as follows:

- To continue programming the meter, refer to the menu maps in Appendix A and navigate to the desired menu. Then, proceed to the appropriate section of this manual for instructions.
- To leave the *User Program* and retain the previous settings, press [EXIT] and then press [F1] = NO at the SAVE prompt. Any programming changes will be discarded and you will be returned to the data display.
- To leave the *User Program* and return to measurement mode, press [EXIT] and then press [F2] = YES at the SAVE prompt. Your programming changes will be entered into the meter's memory, and you will be returned to the data display.

MODBUS Register Map

When equipped with the optional MODBUS output card, the GF868 flow transmitter can send flow data and diagnostic information to a flow computer (or SCADA) serially, using a Gould-type RTU protocol. In this case, only the MODBUS function command, 3 (read multiple registers), 6 (write multiple registers) is valid. The format for the data exchange is as follows:

- The **send** command (initiated by the host flow computer or controller) comes in the form:
[time delimiter]<Addr><3><First Register MSB>
<First Register LSB><Register Count MSB>
<Register Count LSB><CRC Low><CRC High>[time delimiter]
- The response (initiated by the host flow computer or controller) comes in the form:
[time delimiter]<Addr><3><Byte count><Data.....>
<CRC Low><CRC High>[time delimiter]

The format for the returned data types is as follows:

- Integer (16 bit Integer) <MSB><LSB>
1 Register - 16 bit integer
- Integer (32 bit IntegerI) <MSB><LSB><LSB><LSB>
2 Register - 32 bit integer
- Floating Point (FP) <EXP><MAN><MAN><MAN>
2 Registers - 32 bit IEEE floating point number

To request specific parameters from the GF868 using the MODBUS, the control system must enter the appropriate register number. Only registers 1 through 90 are available for MODBUS communications, while registers 508 through 512 are used by the GF868 to store the MODBUS parameters. For details, see Table 1-4 on the next page.

Note: *If you request Ch2 or AVE data from a 1-Channel meter, the values will all be zero.*

Table 1-4: MODBUS Registers for a 1-Channel GF868

MODBUS Reg #	DPR Hex Addr	Description	Scaling (decimal places)	Size in Bytes
1	0	¹ "Clear Ch1 Totalizers"	--	2 (16 bit signed)
2	2	Not Used	--	2 (16 bit signed)
3	4	Velocity	2	4 (2 16-bit int)
5	8	Act Volumetric	#Q DIGITS	4 (IEEE 32 bit)
7	C	Std Volumetric	#Q DIGITS	4 (IEEE 32 bit)
9	10	Fwd Totals	#T DIGITS	4 (2 16 bit int)
11	14	Rev Totals	#T DIGITS	4 (2 16 bit int)
13	18	#Tot Digits	0	2
14	1A	Mass Flow	#M DIGITS	4 (IEEE 32 bit)
16	1E	Fwd Mass Totals	#MT DIGITS	4 (2 16-bit int)
18	22	Rev Mass Totals	#MT DIGITS	4 (2 16-bit int)
20	26	#Mass Tot Digits	0	2
21	28	Timer	2	4 (2 16-bit int)
23	2C	Error Code	0	2
24	2E	Sound Speed	3	4 (2 16-bit int)
26	32	Molecular Weight	4	4 (2 16-bit int)
28	36	Signal Strength Upstream	1	4 (2 16-bit int)
30	3A	Signal Strength Downstream	1	4 (2 16-bit int)
32	3E	Temperature	2	4 (2 16-bit int)
34	42	Pressure	3	4 (2 16-bit int)
508	3F6	² MODBUS baud rate	0	2
509	3F8	³ MODBUS parity	0	2
510	3FA	⁴ MODBUS stop bits	0	2
511	3FC	MODBUS meter addr	0	2
512	3FE	RESERVED	---	---

Notes:

1. Clear Totalizers:

flag from the 8051 to clear either the Channel 1 or Channel 2 totalizers.

2. MODBUS baud rate:

5 = 2400, 6 = 4800, 7 = 9600, 8 = 19,200

3. MODBUS parity:

0 = none, 1 = odd, 2 = even

4. MODBUS stop bits:

1 = 1 stop bit, 2 = 2 stop bits

5. AVG Error Code:

0=Both Ch1 and Ch2 are in error.

1=Ch1 only is in error

2=Ch2 only is in error

3=Both channels are error free

- 6.** You must scale measurements in the host system. For example, velocity scaling is two decimal places; thus, if the MODBUS card reports that the velocity is 100, the host system must interpret the number as 1.00 (two decimal places).

Saving Site Data

The currently programmed site data may be stored in the Model GF868's non-volatile memory by saving it as a site file. Up to ten site file names, consisting of up to five characters each, may be stored at any given time. While following the programming instructions, refer to Figure A-3 on page A-3. Enter the SAVE submenu by pressing [→] and [F4] at the initial *User Program* screen and complete the following steps:

1. Enter a new site file name and press [ENT], or use the [←], [→] and [F1]-[F4] keys to select and overwrite an existing site file.

Note: *The option bar will show only as many choices as there are existing site files.*

If ten site files are already stored in memory, an existing site file must be deleted before a new site file name can be assigned. See Chapter 5, *Clearing Data*, for details.

When a site file is stored in memory, it becomes the active site file until another site file is created or retrieved. (See the next section for instructions on retrieving a site file.) To verify that the site file has been saved, use the [↑] key to scroll back to the SITE NAME prompt and see if the name appears on the option bar (use the [←] and [→] keys to scroll through the list, if necessary). Whenever a new site file name is saved, it is automatically assigned to the next available function key. Press [EXIT] to leave the SAVE submenu.

2. Use the [←] and [→] and [F1]-[F4] keys to select another menu, or press [EXIT] to leave the *User Program* and return to measurement mode.

Recalling a Site

Any site file currently stored in the Model GF868's non-volatile memory may be recalled at any time. Up to ten site file names, consisting of up to five characters each, may be stored at any given time. While following the programming instructions, see Figure A-3 on page A-3. Enter the RECLL submenu by pressing [→] twice and [F1] at the initial *User Program* screen and complete the following steps:

1. Use the [←], [→] and [F1]-[F4] keys to select and recall an existing site file.

Note: *The option bar shows only as many choices as there are existing site files. The files are listed in chronological order by creation date.*

Upon recall, the selected site file becomes active and all of its programmed parameters become current.

IMPORTANT: *The CLOCK and I/O data is not recalled with the site file, while the SYSTM and COMM data is recalled with the site file.*

Note: *If you have loaded a site file into a GF868, but the option cards are not in the same slots or programmed the same way as when the site file was first saved, the GF868 displays a warning to review slot information. This display does not mean that the option cards have lost their program information!*

2. Use the [←] and [→] and [F1]-[F4] keys to select another menu, or press [EXIT] to leave the *User Program* and return to measurement mode.

Activating Security

In order to prevent unauthorized tampering with the flowmeter's programming, the Model GF868 is equipped with a security feature that locks out the following menus:

- Program Menu [PROG]
- Calibration Menu [CAL]
- Log Menu [LOG]
- Clear Menu [CLR]

When the system is locked, access to the above menus will be denied unless the correct password is entered. The Model GF868 is shipped with a *default password*, which is given later in this section. For increased security, the default password should be changed.

IMPORTANT: *Once the system has been locked, it can only be unlocked by entering the password, because access to the SECUR submenu is restricted.*

To program the SECUR submenu, press [→] twice and [F2] at the initial *User Program* screen. Refer to Figure A-3 on page A-3.

IMPORTANT: *It is recommended that all program parameters be recorded before changing the password. (This information should be recorded in Appendix B, Data Records, as a matter of routine.) If the password is lost, the site data is not retrievable and will have to be re-entered.*

1. At the *Lock Out* prompt, press [F1] = UNlck to unlock the system and return to the Global PROGRAM prompt, or press [F2] = LOCK to lock the system.

Note: *If the system was unlocked at the above prompt, the following three prompts do not appear.*

2. *Enter the current Password (2719 is the default password) and press [ENT].*
3. At the *?Edit Password* prompt, press [F1] = NO to leave the password unchanged and proceed to *Procedure Options* on the next page, or press [F2] = YES to enter a new password.

IMPORTANT: *Since the default password is printed in this manual, a new password should be entered. If the password is ever lost, contact the factory for assistance.*

Activating Security (cont.)

4. Enter the *New Password* and press [ENT]. Any combination of letters and numbers up to a total of 21 characters may be used as a password.

Note: *Keep in mind that the password may have to be entered frequently from the keypad. A long and/or complex password may soon become annoying to use.*

5. Verify the *New Password* by entering it again and press [ENT]. Be sure to record the new password in a safe place.

Procedure Options

After completing the above steps, the meter returns to the *User Program* prompt. Continue as follows:

- To continue programming the meter, refer to the menu maps in Appendix A and navigate to the desired menu. Then, proceed to the appropriate section of this manual for instructions.
- To leave the *User Program* and retain the previous settings, press [EXIT] and then press [F1] = NO at the SAVE prompt. Any programming changes will be discarded and you will be returned to the data display.
- To leave the *User Program* and return to measurement mode, press [EXIT] and then press [F2] = YES at the SAVE prompt. Your programming changes will be entered into the meter's memory, and you will be returned to the data display.

Chapter 2

Displaying Data

- Introduction..... 2-1
- The BIG Submenu..... 2-2
- The DUAL Submenu..... 2-3
- The GRAPH Submenu..... 2-4
- The LOG Submenu..... 2-7
- Displaying the Transducer Signal..... 2-11
- Setting the LCD Backlight..... 2-14
- Activating Sleep Mode..... 2-15

Introduction

This chapter explains how to display measurement data in various formats. Each of the two display screen panes may be programmed independently.

Note: *The instructions in this chapter assume that the left display pane is active. If the right display pane is active, simply change all [F1]-[F4] designations to [F5]-[F8].*

The following submenus are included in the *Display Menu*:

- BIG - displays a single measurement in large size text
- DUAL - permits the simultaneous display of two measurements, in the same screen pane, in standard size text
- GRAPH - displays a graph of either velocity or volumetric flow versus time
- LOG - displays the data stored in a log file either graphically or numerically
- SIGNL - graphically displays any one of five transducer signals versus time
- BACKL - sets the time that the LCD display backlight remains on before it is automatically turned off.
- SLEEP - blanks out the display screen until a key is pressed.

Refer to Figure A-4 on page A-4, and proceed to the appropriate section to set up the Model GF868 display screen(s), using one of the listed submenus.

The BIG Submenu

The BIG format, which is the Model GF868's default power up format, displays one measurement in large print. To select the BIG format and the measurement to display in this format, follow the instructions in this section.

Upon power up, a standard measurement mode display (similar to the one shown below) appears. Press the appropriate side of the [SCREEN] key to activate the desired pane of the display screen, and complete the following steps:

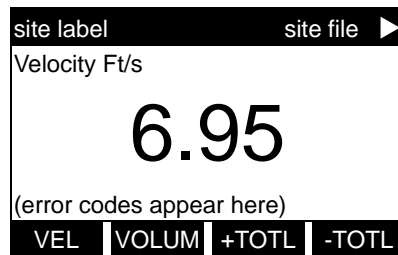

The default power up screen is already in BIG mode. If a different display mode is active, access the *Display Menu* by pressing the [DISP] key.

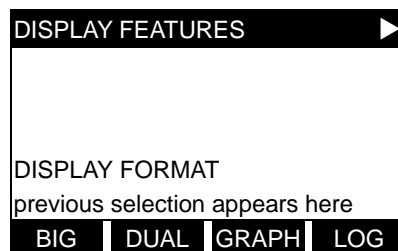

Press [F1] to select the BIG option. The measurement mode screen reappears with the display in the BIG format.

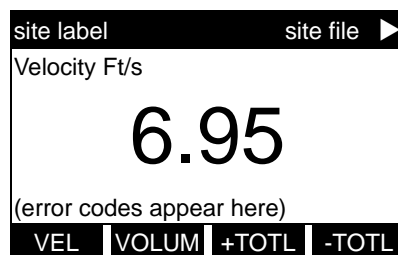

Use the [F1]-[F4], [←] and [→] keys to select the desired display parameter option. See Table 2-1 below for a complete description of the available options.

Table 2-1: Measurement Parameter Options

Option Bar Choice	Description
[F1] = VEL	Flow Velocity
[F2] = VOLUM	Volumetric Flow
[F3] = +TOTL	Forward Totalized Volume Flow
[F4] = -TOTL	Reverse Totalized Volume Flow
[→] + [F1] = TIME	Total Flow Measurement Time
[→] + [F2] = MDOT	Mass Flow
[→] + [F3] = +MASS	Forward Totalized Mass Flow
[→] + [F4] = -MASS	Reverse Totalized Mass Flow
[→] + [→] + [F1] = DIAG	Diagnostic

Note: See Chapter 3, Operation, of the Startup Guide for more details on selecting a measurement parameter to display.

The DUAL Submenu

The DUAL format displays two measurements simultaneously in normal print. To select the DUAL format and the measurements to display in this format, follow the instructions in this section.

Upon power up, a standard measurement mode display (similar to the one shown below) appears in BIG format. Press the appropriate side of the [SCREEN] key to activate the desired pane of the display screen, and complete the following steps:

1. To access the *Display Menu*, press the [DISP] key.
2. Press [F2] = DUAL. The measurement mode display reappears and the display is now in the DUAL format.
3. Use the [F1]-[F4], [←] and [→] keys to select the desired display parameter option. See Table 2-1 on page 2-2 for a complete description of the available options.

Note: See Chapter 3, Operation, of the Startup Guide for more details on selecting a measurement parameter to display.

With the DUAL format display screen active, when a measurement parameter is selected, the top line of the prompt area will be changed to show that parameter. The parameter previously displayed at the top of the display is moved to the bottom of the display, and the previous bottom parameter is no longer shown.

The GRAPH Submenu

The GRAPH submenu permits the display of either the flow velocity, mass flow or the volumetric flow on an XY bar graph, with a specified time interval on the x-axis. This section describes the procedures for setting up and using the graph format.

Setting Up the GRAPH Format

Press the appropriate side of the [SCREEN] key to activate the desired pane of the display screen, and complete the following steps:

1. To access the *Display Menu*, press the [DISP] key.
2. Press [F3] = GRAPH.
3. Press [F1]-[F3] to graph the *Flow Velocity*, *Volumetric Flow* or *Mass Flow*, respectively.
4. Use the [←], [→] and [F1]-[F4] keys to select the desired *Time Increment*.
5. Enter a maximum value for the *Y-axis* (vertical) scale that is larger than the maximum expected reading and press [ENT].
6. At the *Y Range* prompt, press [F1] to graph only positive Y values or press [F2] to graph both positive and negative Y values.

After the Y RANGE is entered, the Model GF868 automatically begins taking measurements and displays them in the specified graphical format. Proceed to the next section for a discussion of manipulating the graphical display.

Using the GRAPH Format

While viewing data in the GRAPH format, the function keys are programmed to permit a variety of actions. These options are described in detail below.

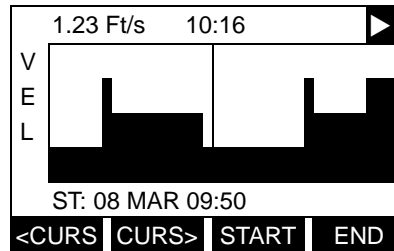

Use the [←], [→] and [F1]-[F4] keys to select the desired option. See Table 2-2 on the next page for a listing of the available choices.

At any given time, 120 data points will be shown on the GRAPH screen. The *cursor*, which is displayed as a vertical line that extends the full height of the graph window, can be used to select any one of these data points.

The typical screen shown above is for a *Velocity vs. Time* graph with only the positive y-axis displayed. The measurement parameter (VEL) is shown to the left of the y-axis and there is a *message line* below the graph that initially indicates the starting date and time of the graphed data. Notice that most of the locator bar has been replaced by a *status line* in standard video that shows the value, units and time of the measurement at the current cursor location. However, there is still an inverse video *pointer* at the far right of this line to indicate that additional option bar choices are available.

Note: *The date in the message line includes only the day and the month (not the year), and the times in the status line and the message line include only the hours and minutes (not the seconds).*

Because the times displayed in the GRAPH format are in whole minutes only, movement of the cursor may not result in a visible change in the posted times. For example, if a TIME INCREMENT of 30 seconds has been programmed, two presses of either cursor movement key will be required to change the displayed time by one minute.

Using the GRAPH Format
(cont.)

Table 2-2: Graph Display Options

Option Bar Choice	Description
[F1] = <CURS	Moves the cursor to the left and displays the corresponding measurement value and time in the status line: (i.e. 6.85 Ft/s 10:38)
[F2] = CURS>	Moves the cursor to the right and displays the corresponding measurement value and time in the status line: (i.e. 5.31 Ft/s 10:38)
[F3] = START	Moves the cursor all the way to the left side of the graph and posts the starting date and time in the message line: (i.e. ST: 08 MAR 10:38)
[F4] = END	Moves the cursor all the way to the right side of the graph and posts the ending date and time in the message line: (i.e. END 08 MAR 11:14)
[→] + [F1] = YMAX	Displays the programmed maximum Y value in the message line: (i.e. YMAX 25.0 Ft/s)
[→] + [F2] = T INC	Displays the programmed time increment value in the message line: (i.e. T INC 30 seconds)
[→] + [F3] = EXIT	Leaves the GRAPH format and returns the display to the previous data format. (The [EXIT] key on the keypad will also perform this function.)

The LOG Submenu

The LOG submenu permits the display of the data in a log file either graphically or numerically. Although the Model GF868 can display all of the data in a log file, screen size limitations prevent the simultaneous display of the complete log file. Therefore, the function keys must be used to view the remaining data. Follow the instructions in this section to display a log file in the desired format.

Entering the LOG Submenu

Press the appropriate side of the [SCREEN] key to activate the desired pane of the display screen, and complete the following steps:

1. To access the *Display Menu*, press the [DISP] key.
2. Press [F4] = LOG.
3. Use the [←], [→] and [F1]-[F4] keys to select the desired log file to display. At the NAME prompt, the option bar will show the names of all log files that are currently stored in memory. If there are no log files currently stored in memory, the following prompt will appear instead:

```

DISPLAY FEATURES
DISPLAY FORMAT
logging
All Logs Cleared!
hit key

```

There are no log files currently stored in memory. Either all of the log files have been cleared or no log files have yet been created. Press any key to return to measurement mode.

If the All Logs Cleared! prompt appears, at least one log file must be created and stored in memory before the *Display Log* function can be accessed. See Chapter 3, *Logging Data*, for instructions on creating a log file. After at least one log file is stored in memory and selected at the NAME prompt of the LOG submenu, proceed to the next step.

4. At the *Format* prompt, press [F1] to display the selected log in numeric format or press [F2] to display the selected log in graphical format.
 - If you pressed [F1], go to the next page.
 - If you pressed [F2], go to page 2-9.

Numeric Format

The Model GF868 can log up to three parameters simultaneously. Each set of data values is called a *record*, and up to 120 consecutive records can be stored in a *page*. A *log file* can consist of up to 120 pages. The numeric log display, which shows one record at a time, includes the following components:

- page number
- record number
- time and date of creation
- measurement value set
- error messages (if any)

Upon choosing NUM at the FORMAT prompt, the first record of the selected log file is displayed in a screen similar to the following:

```

PAGE# 1      REC# 80
              09 MAR 98
              11.66 Ft/s
              1.32 KACF/MI
              6.91 KACF
E5: Amplitude
<CURS | CURS> | <PAGE | PAGE>
    
```

Use the [←], [→] and [F1]-[F4] keys to view additional records or to exit the log display. The options are listed in Table 2-3 below.

In the numeric display screen, the locator bar (except for the inverse video pointer at the far right) is replaced by a standard video display of the page number and record number. The first line of the prompt area shows the time and date that the record was created, and the next three lines list the values for the three logged parameters. Finally, any error condition that existed at the time the record was taken is indicated by an error code in the bottom line of the prompt area.

Table 2-3: Numeric Log Display Options

Option Bar Choice	Description
[F1] = <CURS	display previous record on the current page
[F2] = CURS>	display the next record on the current page
[F3] = <PAGE	display the previous page
[F4] = PAGE>	display the next page
[→] + [F1] = START	display the first record on the current page
[→] + [F2] = END	display the last record on the current age
[→] + [F3] = EXIT	Leave the numeric LOG display and return to the previous data format. (The [EXIT] key on the keypad will also perform this function.)

Graphical Format

After choosing PLOT at the FORMAT prompt, the programming sequence continues as follows:

5. Enter a maximum value for the *Y-axis* (vertical) scale that is larger than the maximum expected reading. Press [ENT].
6. At the *Y Range* prompt, press [F1] to graph only positive *Y* values or press [F2] to graph both positive and negative *Y* values.

After the *Y RANGE* is entered, the Model GF868 automatically displays the chosen log file records in the specified graphical format.

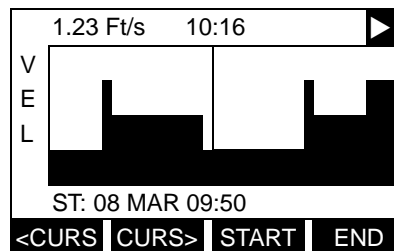

Use the [←], [→] and [F1]-[F4] keys to select the desired option. The options are listed in Table 2-4 below.

At any given time, the 120 records stored in one page of the log file will be graphed on the display screen. The *cursor*, which is shown as a vertical line that extends the full height of the graph window, can be used to highlight any one of these records.

IMPORTANT: *Only the first of the three logged parameters is displayed in the graphical format of the LOG submenu. Therefore, when creating a log file, be sure to specify the parameter to be graphed at the 1st Value Logged prompt. See Chapter 3, Logging Data, for details on creating a log file.*

Graphical Format (cont.)

Table 2-4: Graphical Log Display Options

Option Bar Choice	Description
[F1] = <CURS	Move the cursor one record to the left and display the value and time of that record in the status line: (i.e. 6.85 Ft/s 10:38)
[F2] = CURS>	Move the cursor one record to the right and display the value and time of that record in the status line: (i.e. 5.31 Ft/s 10:38)
[F3] = <PAGE	Display the previous page of records
[F4] = PAGE>	Display the next page of records
[→] + [F1] = START	Move the cursor to the first record on the current page and post the date and time of that record in the message line: (i.e. ST: 08 MAR 10:38)
[→] + [F2] = END	Move the cursor to the last record on the current page and post the date and time of that record in the message line: (i.e. END 08 MAR 11:14)
[→] + [F3] = YMAX	Display the programmed maximum Y value in the message line: (i.e. YMAX 25.0 Ft/s)
[→] + [F4] = T INC	Display the time increment value, as set when the log file was created, in the message line: (i.e. T INC 30 seconds)
[←] + [F1] = EXIT	Leave the graphical LOG display and return the display to the previous data format. (The [EXIT] key on the keypad will also perform this function.)

In the typical graphical display shown, the first logged parameter (VEL) is shown to the left of the y-axis and there is a *message line* below the graph that initially indicates the starting date and time of the current page. Notice that most of the locator bar has been replaced by a *status line* in standard video that shows the value, units and time of the record at the current cursor location. However, there is still an inverse video *pointer* at the far right of this line to indicate that additional option bar choices are available.

Note: *The date in the message line includes only the day and the month (not the year), and the times in the status line and the message line include only the hours and minutes (not the seconds).*

Because the times displayed in the LOG graph are in whole minutes only, movement of the cursor may not result in a visible change in the posted times. For example, if a TIME INCREMENT of 30 seconds has been programmed, two presses of either cursor movement key will be required to change the displayed time by one minute.

Displaying the Transducer Signal

The SIGNAL submenu permits the direct graphical display of several transducer signals. Specifically, the signals listed in Table 2-5 below may be viewed in this format.

Table 2-5: Available Transducer Signals

Transducer Signal	Description
Skam Types	
Sup	upstream Skam signal
Sdown	downstream Skam signal
Cup	upstream Skam correlation
Cdown	downstream Skam correlation
Measure Types	
Mup	upstream Measure signal
Mdown	downstream Measure signal

Note: *The Measure type signals (Mup and Mdown) are only available if the S/M burst technique was selected in the ACTIV menu.*

Refer to Figure A-4 on page A-4 and complete the following steps to display the transducer signals. Press the appropriate side of the [SCREEN] key to activate the desired pane of the display screen, then proceed as follows:

Note: *For this discussion, it is assumed that the left pane of the display screen is active. If the right pane is active, it is only necessary to replace the [F1]-[F4] keys designations by the [F5]-[F8] keys.*

1. To access the *Display Menu*, press the [DISP] key.
2. Press [→] and [F1] = SIGNAL.
3. Press [F1] to display the Skam type signals or press [F2] to display the Measure type signals.

Note: *If the Skam burst technique was selected in the ACTIV menu, the Signal to Display prompt does not appear and the Measure type signals are not available. To access these signals, the S/M burst technique must be selected.*

The signal graph is a plot of signal amplitude (y-axis) vs. time in microseconds (x-axis). When the SIGNAL display screen first appears, it may briefly remain blank. As soon as the signal is acquired, processed and loaded into the display memory, the graph will appear. A *cursor*, which is displayed as a vertical line that extends the full height of the graph window, is used to highlight any point in time along the x-axis.

**Displaying the
Transducer Signal (cont.)**

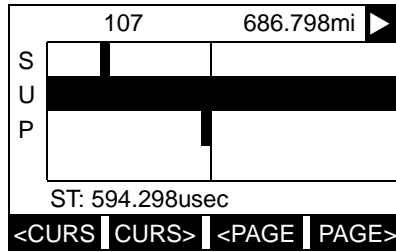

Use the [←], [→] and [F1]-[F4] keys to select the desired option. The options are listed in Table 2-6 below.

The typical display screen shown has the Sup transducer signal listed to the left of the y-axis and there is a *message line* below the graph that initially indicates the starting date and time of the graphed signal. Notice that most of the locator bar has been replaced by a *status line* in standard video that shows the signal amplitude and the time (in microseconds) of the measurement at the current cursor location. However, there is still an inverse video *pointer* at the far right of this line to indicate that additional option bar choices are available.

Table 2-6: Graphical Log Display Options

Option Bar Choice	Description
[F1] = <CURS	Move the cursor to the left and display amplitude and time in the status line: (i.e. 107 686.798mi)
[F2] = CURS>	Move the cursor to the right and display amplitude and time in the status line: (i.e. 107 686.798mi)
[F3] = <PAGE	Display the previous page
[F4] = PAGE>	Display the next page
[→] + [F1] = START	Move the cursor to the start of the current page and post the starting date and time in the message line: (i.e. ST: 451.798usec)
[→] + [F2] = END	Move the cursor to the end of the current page and post the ending date and time in the message line: (i.e. END: 744.298usec)
[→] + [F3] = YMAX	Display the maximum Y value, which is set to 128 divisions in arbitrary units, in the message line.
[→] + [F4] = T INC	Display the time increment value in the message line. This is based on the frequency of the transducers (equal to 0.125 μsec for a 1 MHz transducer).
[←] + [F1] = EXIT	Leave the graphical SIGNAL display and return the display to the previous data format. (The [EXIT] key on the keypad will also perform this function.)

Displaying the Transducer Signal (cont.)

In addition to the functions available on the option bar, some of the numeric keys are used to specify which transducer signal is displayed and to scale the resulting graph. Table 2-7 below lists these functions.

Table 2-7: Numeric Key Functions

Key	Function
1	Scroll down the transducer signal list
2	Scroll up the transducer signal list
4	Expand the graph vertically
5	Return expanded graph to previous size
7	Compress graph horizontally
8	Return compressed graph to previous size

In summary, three basic functions are performed with the numeric keys:

- **Signal Selection:** use the “1” and “2” keys to select a transducer signal for display by scrolling through the list of available signals.
- **Vertical Scaling:** The “4” and “5” keys are used to scale the graph vertically. Each press of the “4” key doubles the height of the graph, while each press of the “5” key halves the height of the graph. The three available scale factors are 1x, 2x and 4x.
- **Horizontal Scaling:** The “7” and “8” keys are used to scale the graph horizontally. Each press of the “7” key doubles the T INC value (2x horizontal compression), while each press of the “8” key halves the T INC value (2x horizontal expansion). The four available compression ratios are 1x, 2x, 4x and 8x.

To return to the standard data screen either select EXIT from the option bar or press the [EXIT] key on the keypad.

Setting the LCD Backlight Use the BACKL submenu to specify the number of minutes the LCD display backlight remains on before it is automatically turned off. Press the appropriate side of the [SCREEN] key to activate the desired pane of the display screen, then proceed as follows:

Note: *For this discussion, it is assumed that the left pane of the display screen is active. If the right pane is active, replace the [F1]-[F4] keys designations by the [F5]-[F8] keys.*

1. To access the *Display Menu*, press the [DISP] key.
2. Press [→] and [F2] = BACKL.
3. Use the numeric keys to enter a value from 1 to 60 minutes and press [ENT]. To keep the backlight on constantly, enter a value of 0 and press [ENT].

The Model GF868 will automatically return to the previous data display screen and the programmed backlight timeout interval will begin.

If no entries are made from the keypad before the backlight timeout interval expires, the backlight will automatically be turned off. At the next keypad entry, the backlight will be turned on and the specified timeout interval will begin again.

Activating Sleep Mode

During times when the display is not in use, use the SLEEP submenu to temporarily suspend LCD display activity, which allows the Model GF868 to process data more quickly. Press the appropriate side of the [SCREEN] key to activate the desired pane of the display screen, then proceed as follows:

Note: *For this discussion, it is assumed that the left pane of the display screen is active. If the right pane is active, replace the [F1]-[F4] keys designations by the [F5]-[F8] keys.*

1. To access the *Display Menu*, press the [DISP] key.
2. Press [→] and [F3] = SLEEP. The message “LCD SLEEP MODE -Press any key. . .” appears.
3. To reactivate the display and return to the previous data screen, press any key on the keypad. The Model GF868 will automatically return to the previous data display screen.

Note: *With BIG as the selected display format, exiting SLEEP mode may not erase the sleep mode message and the data screen will be superimposed on the message. If this occurs, simply enter the DISP menu and reselect the BIG format to refresh the screen. See the instructions earlier in this chapter.*

Chapter 3

Logging Data

Introduction.....	3-1
Creating a Standard Log.....	3-2
Checking the Memory.....	3-7
Stopping a Log	3-8
Creating an ERROR Log.....	3-9

Introduction

This chapter explains how to use the Model GF868's data logging capability. The LOG menu, which is accessed by pressing the [LOG] key on the keypad, is divided into four submenus:

- STD - used to log up to three of the available measurement data parameters
- MEM - used to check the data logger memory to determine if the specified log will exceed the available memory
- STOP - used to terminate current data logging activity
- ERROR - used to log any generated error messages.

Up to twenty standard or error log files may be created and stored in battery-backed memory. Each log file contains up to three measurement parameters, the log start time and date, the log end time and date, the time interval between updates, and any error messages. Error logs record data only when an error message is generated.

The Model GF868 allocates up to 120 *pages* of memory, each of which can contain up to 120 *records*, for data logging. Each page is assigned a *header*, to distinguish one page from another. The header contains the log title, start date and time, end date and time, and the time increment. Each record contains the date and time of the measurement and the values for the three logged parameters.

Note: *Each log file uses at least one page of memory, and the same page can not be shared by two different logs.*

Since a fixed amount of memory is allocated for data logging, the number of active logs, the log time increments, and the length of the log runs will all affect how much memory is available for additional logging. For example, a log that updates every 5 seconds will use more memory than a log that updates every 6 minutes, assuming that they both run for the same length of time.

After a log file has been created, it may be displayed, printed, cleared or uploaded to a personal computer. Refer to the appropriate chapters of this manual for specific instructions.

Refer to Figure A-6 on page A-6 and proceed to the appropriate section for the desired LOG submenu. Each submenu may be followed in the sequence shown or the [↑] and [↓] keys may be used to scroll through the prompts.

Creating a Standard Log

Use the STD submenu to create a new standard log and to select the parameters to log, the log start time and date, the log end time and date, and the time increment. Also, any log file already stored in memory may be inspected and/or changed.

Press the appropriate side of the [SCREEN] key to activate the desired pane of the display screen, and complete the following steps:

1. To access the *Log Menu*, press the [LOG] key.
 - a. If you have activated the security feature (see Chapter 1, *Programming Site Data*, page 1-41 for details), enter the assigned password and press [ENT].
2. Press [F1] = STD.
3. Use the [←], [→] and [F1]-[F4] keys to inspect a completed log or to change an active log, or enter a new name (up to 5 characters) and press [ENT] to create a new log file.

Note: *At the NAME prompt, the option bar will show the names of all completed or active log files that are currently stored in memory. Recall that a flashing asterisk (*) appears at the far right of the locator bar if the Model GF868 is currently logging data (see Chapter 3, Operation, of the Startup Guide).*

4. At the *Log Message* prompt, enter a brief description (up to 21 characters) of the log. Press [ENT].
5. Use the [←], [→] and [F1]-[F4] keys to select the first parameter to be logged. See Table 3-1 below for a list of the available options.

IMPORTANT: *Only the first parameter logged may be graphically displayed in the LOG Submenu of the Display Menu. Keep this in mind when selecting a parameter. See Chapter 2, Displaying Data, for instructions.*

Table 3-1: Measurement Parameter Options

Option Bar Choice	Description
[F1] = VEL	Flow Velocity
[F2] = VOLUM	Volumetric Flow
[F3] = +TOTL	Forward Totalized Volume Flow
[F4] = -TOTL	Reverse Totalized Volume Flow
[→] + [F1] = MDOT	Mass Flow
[→] + [F2] = +MASS	Forward Totalized Mass Flow
[→] + [F3] = -MASS	Reverse Totalized Mass Flow
[→] + [F4] = DIAG	Diagnostic

Creating a Standard Log (cont.)

Refer to Chapter 3, *Diagnostics*, of the *Service Manual* for a discussion of the many parameters accessible using the DIAG option.

Note: *The units assigned to the parameters in Table 3-1 on page 3-2 are those selected in the User Program (SYSTEM submenu).*

6. Use the [←], [→] and [F1]-[F4] keys to select the second parameter to be logged.
7. Use the [←], [→] and [F1]-[F4] keys to select the third parameter to be logged.
 - If you selected a totaled value for display, go to step 8.
 - If you did not, go to step 9.
8. At the *Set Log Totals to 0* prompt, press [F1] to leave the log totals at their present value or press [F2] to reset the log totals to zero. Choosing YES at this prompt only resets the log totals to zero and has no effect on the meter totals.

Log Type

9. Press [F1] to create a non-circular log or press [F2] to create a circular log.

A non-circular log automatically stops when the meter runs out of memory or the specified END TIME is reached. A circular log runs continuously until manually stopped, but only the data from the most recent log cycle is saved. At the start of each cycle, the oldest recorded data is overwritten by the new data from the current cycle.

Caution!

If data from one circular log cycle exceeds the meter's memory capacity, the earliest logged data will be lost.

STARTTIME Prompt

10. Press [F1] to accept the displayed start time or press [F2] to enter a different start time. To start logging immediately, press [F3].
 - If OK was selected, proceed to step 11.
 - If NOW was selected, proceed to step 12 if you selected a the non-circular log or to step 14 for a circular log.
 - If EDIT was selected, complete the steps listed on the next page.

STARTTIME Prompt (cont.)

- a. Press [F1]-[F2] to select AM or PM. Then, enter the desired *Hour* (1-12) and press [ENT]. (Entry of a start time earlier than the current time will generate an error message.)
- b. Enter the desired *Minutes* and press [ENT]. The acceptable range is 0 to 59.
- c. Enter the desired *Seconds* and press [ENT]. The acceptable range is 0 to 59.

START DATE Prompt

11. Press [F1] to accept the displayed *Start Date* or press [F2] to enter a different start date. To start logging today, press [F3].
 - If OK or TODAY was selected, proceed to step 12 for a non-circular log or to step 13 for a circular log.
 - Otherwise, complete the following steps to *Edit* the Start Date.
 - a. Enter the desired *Year* and press [ENT]. The acceptable range is 0 to 99.
 - b. Use the [←], [→] and [F1]-[F4] keys to select the desired *Month*.
 - c. Enter the desired *Day* and press [ENT]. The acceptable range is 1 to the number of days in the selected month (28, 29, 30 or 31).

END TIME Prompt

12. Press [F1] to accept the displayed *End Time* or press [F2] to enter a different end time. To select a specific time period for the log to run, press [F3].
 - If OK was selected, proceed to the END DATE prompt.
 - If TIMED was selected, proceed to the LOG TIME prompt.
 - If EDIT was selected, complete the steps on the next page.

Note: *The log END TIME must exceed the log START TIME by at least five minutes. Failure to observe this restriction will result in an error message.*

- a. Press [F1]-[F2] to select AM or PM. Then, enter the desired *Hour* (1-12) and press [ENT]. (Entry of a start time earlier than the current time will generate an error message.)
- b. Enter the desired *Minutes* and press [ENT]. The acceptable range is 0 to 59.
- c. Enter the desired *Seconds* and press [ENT]. The acceptable range is 0 to 59.

- END DATE Prompt
- 13.** Press [F1] to accept the displayed end date or press [F2] to enter a different end date. To end the log today, press [F3].
- If OK or TODAY was selected, proceed to the TIME INCREMENT prompt. Refer to Figure A-6 on page A-6 for a flow diagram of the programming sequences.
 - Otherwise, complete the steps below.
 - a. Enter the desired *Year* and press [ENT]. The acceptable range is 0 to 99.
 - b. Use the [←], [→] and [F1]-[F4] keys to select the desired *Month*.
 - c. Enter the desired *Day* and press [ENT]. The acceptable range is 1 to the number of days in the selected month (28, 29, 30 or 31). The program proceeds to step 15.
- DURATION Prompt
- If a circular log was specified, the programming sequence continues here after the log start time and/or start date is entered.
- 14.** Press [F1] and enter a log duration in hours or press [F2] and enter a log duration in days. When the desired value has been entered, press [ENT]. The program proceeds to step 16.
- LOG TIME Prompt
- If TIMED was selected at step 12, the programming sequence continues here.
- 15.** Use the [←], [→] and [F1]-[F4] keys to select the desired log duration. The available options are: 10min, 30min, 60min, 3 HR, 6 HR, 12 HR and 24 HR.
- TIME INCREMENT Prompt
- Regardless of which of the various options were selected during the previous programming steps, all of the paths converge at this point.
- 16.** Use the [←], [→] and [F1]-[F4] keys to select the desired *Time Increment*. The available options are: 5sec, 10sec, 30sec, 1min, 3min, 6min, 12min, 30min and 60 min.
- The time increment is the frequency at which the Model GF868 takes and records data measurements. If any reading takes longer than the programmed time increment, the log is filled in with the next consecutive reading. For example, assume that a velocity value of 3 ft/sec is recorded at 12:00:00 in a log with a time increment of five seconds. If the next reading is 8 ft/sec and it takes the meter 12 seconds to read this value, then both of the missed readings (12:00:05 and 12:00:10) will be filled in with the 8 ft/sec value.

Procedure Options

You have completed entering data for a standard log. You can now do one of the following:

- Use [↑] and [↓] to review the previous menu prompts.
- Press [F1]-[F4] to select one of the LOG submenus.
- To return to the data screen and begin logging data, press the [ENT] key.

Although each log is restricted to only three logged parameters, it is still possible to log more than three parameters. Simply re-enter the STD submenu as many times as necessary to set up additional logs. Select the other desired parameters, and run these logs simultaneously with the first log.

Checking the Memory

Use the MEM submenu to verify that the available log memory is sufficient for the desired log. If the expected amount of logged data will exceed the remaining memory capacity, the Model GF868 suggests that some old logs be cleared to make room for the new log.

Press the appropriate side of the [SCREEN] key to activate the desired pane of the display screen, and complete the following steps:

1. To access the *Log Menu*, press the [LOG] key.
 - a. If you have activated the security feature (see Chapter 1, *Programming Site Data*, page 1-41 for details), enter the assigned password and press [ENT].
2. Press [F2] = MEM.
3. After noting the information, press [ENT] to return to the main *Log Menu* screen.

The MEM screen lists the number of remaining unused memory pages out of the total number of 120 available pages. Also, the number of pages expected to be used by all currently programmed logs is given. If the number of pending pages exceeds the number of free pages, additional memory may be made available by clearing some old logs (see Chapter 5, *Clearing Data*).

If it is undesirable to delete old logs to free up additional memory, the number of pages pending may be reduced by altering the parameters of one or more of the currently active logs. For example, either increasing the time increment or decreasing the total logging time will reduce the memory requirements for a log file. Use the following equations to calculate the number of pages used by a log:

$$\text{number of records} = \frac{\text{length of log}}{\text{time increment}} \quad (3-1)$$

$$\text{number of pages} = \frac{\text{number of records}}{120} \quad (3-2)$$

Consider a log that is set to run for 24 hours with a time increment of 3 minutes. From Equation 3-1, the number of records = $(24 \times 60)/3 = 480$ records. Then, from Equation 3-2 above, the number of pages = $480/120 = 4$ pages. Thus, at least four pages of memory must be available for this log to run to completion. Notice that increasing the time increment to 6 minutes or decreasing the length of the log to 12 hours would reduce the memory requirement to only 2 pages.

Stopping a Log

Use the STOP submenu to terminate a logging process that is currently active. Press the appropriate side of the [SCREEN] key to activate the desired pane of the display screen, and complete the following steps:

1. To access the *Log Menu*, press the [LOG] key.
 - a. If you have activated the security feature (see Chapter 1, *Programming Site Data*, page 1-41 for details), enter the assigned password and press [ENT].

Note: *Once a log is stopped it cannot be restarted, but the log remains in memory. To clear the log from memory, refer to Chapter 5, Clearing Data, for instructions.*

2. Press [F3] = STOP.
3. Use the [←], [→] and [F1]-[F4] keys to select a log file to stop.

Note: *At the NAME prompt, the option bar will show the names of all completed or active log files that are currently stored in memory. Recall that a flashing asterisk (*) appears at the far right of the locator bar if the Model GF868 is currently logging data (see Chapter 3, Operation, of the Startup Guide).*

4. Press [F1] to continue logging and return to the initial *Log Menu* screen. Press [F2] to stop logging and return to the initial *Log Menu* screen.

Procedure Options

Do one of the following:

- Press [F1]-[F4] to enter another LOG submenu.
- Press [EXIT] to return to the data screen.

Creating an ERROR Log

Use the ERROR submenu to create a new error log and to select the logging parameters. An error log updates every 5 seconds (when the display updates), but only if a new error condition occurs. Error logs have a fixed length of 2 pages and contain sixty records per page. Each record shows the time of the error, the measurement parameter values at that time, and the error code message. The logged values of the chosen measurement parameters at the time of the error condition provide valuable troubleshooting information.

Press the appropriate side of the [SCREEN] key to activate the desired pane of the display screen, and complete the following steps:

1. To access the *Log Menu*, press the [LOG] key.
 - a. If you have activated the security feature (see Chapter 1, *Programming Site Data*, page 1-41 for details), enter the assigned password and press [ENT].
2. Press [F4] = ERROR.
3. Use the [←], [→] and [F1]-[F4] keys to inspect a completed log or to change an active log, or enter a new *Name* (up to 5 characters) and press [ENT] to create a new log file.

Note: *The option bar lists all error logs currently stored in memory. Recall that a flashing asterisk (*) appears at the far right of the locator bar if the Model GF868 is currently logging data (see Chapter 3, Operation, of the Startup Guide).*

4. At the Log Message prompt, enter a brief description (up to 21 characters) of the log. Press [ENT].
5. Use the [←], [→] and [F1]-[F4] keys to select the first parameter to be logged. See Table 3-2 below for a list of the available options.

IMPORTANT: *Only the first parameter logged may be graphically displayed (see Chapter 2, Displaying Data).*

Table 3-2: Measurement Parameter Options

Option Bar Choice	Description
[F1] = VEL	Flow Velocity
[F2] = VOLUM	Volumetric Flow
[F3] = +TOTL	Forward Totalized Volume Flow
[F4] = -TOTL	Reverse Totalized Volume Flow
[→] + [F1] = MDOT	Mass Flow
[→] + [F2] = +MASS	Forward Totalized Mass Flow
[→] + [F3] = -MASS	Reverse Totalized Mass Flow
[→] + [F4] = DIAG	Diagnostic

Creating an ERROR Log (cont.)

In addition, refer to Chapter 3, *Diagnostics*, of the *Service Manual* for a discussion of the many parameters accessible using the DIAG option.

Note: *The units assigned to the parameters in Table 3-2 on the previous page are those selected in the User Program (SYSTEM submenu).*

6. Use the [←], [→] and [F1]-[F4] keys to select the second parameter to be logged.
7. Use the [←], [→] and [F1]-[F4] keys to select the third parameter to be logged.
 - If you selected a totaled value for display, go to step 8.
 - If you did not, go to step 9.
8. At the *Set Log Totals to 0* prompt, press [F1] to leave the log totals at their present value or press [F2] to reset the log totals to zero. Choosing YES at this prompt only resets the log totals to zero and has no effect on the meter totals.

Log Type

9. Press [F1] to create a non-circular log or press [F2] to create a circular log.

A non-circular log automatically stops when the meter runs out of memory or the specified END TIME is reached. A circular log runs continuously until manually stopped, but only the data from the most recent log cycle is saved. At the start of each cycle, the oldest recorded data is overwritten by the new data from the current cycle.

Caution!

If data from one circular log cycle exceeds the meter's memory capacity, the earliest logged data will be lost.

STARTTIME Prompt

10. Press [F1] to accept the displayed start time or press [F2] to enter a different start time. To start logging immediately, press [F3].
 - If OK was selected, proceed to step 11.
 - If NOW was selected, you have finished setting up the error log. Proceed to *Procedure Options* on the next page.
 - If EDIT was selected, complete the steps listed on the next page.

- STARTTIME Prompt (cont.)
- a. Press [F1]-[F2] to select AM or PM. Then, enter the desired *Hour* (1-12) and press [ENT]. (Entry of a start time earlier than the current time will generate an error message.)
 - b. Enter the desired *Minutes* and press [ENT]. The acceptable range is 0 to 59.
 - c. Enter the desired *Seconds* and press [ENT]. The acceptable range is 0 to 59.

- START DATE Prompt
11. Press [F1] to accept the displayed *Start Date* or press [F2] to enter a different start date. To start logging today, press [F3].
 - If OK or TODAY was selected, you have finished setting up the error log. Proceed to *Procedure Options* below.
 - Otherwise, complete the following steps to *Edit* the Start Date.
 - a. Enter the desired *Year* and press [ENT]. The acceptable range is 0 to 99.
 - b. Use the [←], [→] and [F1]-[F4] keys to select the desired *Month*.
 - c. Enter the desired *Day* and press [ENT]. The acceptable range is 1 to the number of days in the selected month (28, 29, 30 or 31).

- Procedure Options*
- You have completed setting up the error log. Do one of the following:
- Use [↑] and [↓] to review the previous menu prompts.
 - Press [F1]-[F4] to select one of the LOG submenus.
 - To return to the data screen and begin logging data, press the [ENT] key. The * on the locator bar indicates that the Model GF868 is now compiling the specified error log.

The error log will continue to run until it is manually stopped, the meter runs out of memory (for a non-circular log), or the entire 120 records (2 pages x 60 records/page) have been logged.

Chapter 4

Printing Data

Introduction.....	4-1
Print Live Data	4-2
Printing Logs	4-5
Print Site File	4-7
Stop Printing	4-8
Setting Up a Printer	4-9
Printing Signal Array Data	4-10
Printing RTD Data.....	4-12

Introduction

The Model GF868 flowmeter has the capability to print any of the data stored in its memory using the built-in RS232 communications port. In order to use the function, the RS232 port must be connected to a printer with a serial port input. A printer with a parallel port input may be used with a third-party serial-to-parallel adapter.

Note: *See Chapter 1, Installation, of the Startup Guide for instructions on wiring the RS232 port. For additional information, refer to Chapter 6, Serial Communications.*

After connecting the Model GF868 to a printer, the *Print Menu* is used to print live or logged data in either numeric or graphical format. In addition, any site files stored in memory may be printed. The *Print Menu* is divided into the following submenus:

- DATA - use to print live data in numeric or graphical format
- LOG - use to print a log file in numeric or graphical format
- PROG - use to print a site file
- STOP - use to terminate any active print jobs
- PRNTR - use to specify the printer currently connected
- SGNLS - use to print transducer signal array data
- RTDs - use to send the numeric point value of a connected RTD device to the RS232 port.

For purposes of this discussion it is assumed that the left pane of the data display screen is active. If the right pane of the data display screen is active, all of the instructions remain the same, except that any references to the [F1]-[F4] keys should be replaced by the [F5]-[F8] keys.

Refer to Figure A-5 on page A-5, and proceed to the desired section for detailed instructions. As an additional aid, the relevant portion of the full menu map is reproduced in each section of this chapter. Any submenu may be followed in the sequence shown or the [↑] and [↓] keys may be used to scroll through the prompts.

Note: *If a printer has not yet been set up, the instructions in “The PRNTR Submenu” must be completed before proceeding to any of the other submenus.*

Print Live Data

Use the DATA submenu to print live measurement data, as it is collected. The data may be printed in either numeric or graphical format, with a user specified time increment.

IMPORTANT: *Make sure that a printer has been properly set up before proceeding with this section.*

To print live measurement data, refer to Figure A-5 on page A-5, and complete the following steps:

1. To access the *Print Menu*, press the [PRNT] key.

Note: *The Print Menu is not protected by the security feature and a password is never required to access this menu.*

2. Press [F1] to select the DATA option.
3. Press [F1] = NUM to print the data in numeric format or press [F2] = PLOT to print the data in graphical format.
 - If you press [F1], go to step 4.
 - If you press [F2], go to step 8.
4. Use the [←], [→] and [F1]-[F4] keys to select the first parameter to be printed. See Table 4-1 below for a list of the available options.

Numeric Format

Table 4-1: Measurement Parameter Options

Option Bar Choice	Description
[F1] = VEL	Flow Velocity
[F2] = VOLUM	Volumetric Flow
[F3] = +TOTL	Forward Totalized Volume Flow
[F4] = -TOTL	Reverse Totalized Volume Flow
[→] + [F1] = MDOT	Mass Flow
[→] + [F2] = +MASS	Forward Totalized Mass Flow
[→] + [F3] = -MASS	Reverse Totalized Mass Flow
[→] + [F4] = DIAG	Diagnostic

Refer to Chapter 3, *Diagnostics*, of the *Service Manual* for a discussion of the many parameters accessible using the DIAG option.

Note: *The units assigned to the parameters in Table 4-1 above are those selected in the User Program (SYSTEM submenu).*

Numeric Format (cont.)

5. Use the [←], [→] and [F1]-[F4] keys to select the second parameter to be printed.
6. Use the [←], [→] and [F1]-[F4] keys to select the third parameter to be printed.
7. Use the [←], [→] and [F1]-[F4] keys to select the desired time increment (the frequency at which measurements are taken). The available options are: 5sec, 10sec, 30sec, 1min, 3min, 6min and 12min.

After the time increment is chosen, the Model GF868 returns to the standard data display screen and continues to take measurements. The live data is printed at the specified time intervals, until a STOP command is issued (see the instructions for the STOP submenu). A portion of a typical printout is shown in Figure 4-1 below.

DATA_DUMP OF (SITE NAME)				
Channel LABEL	Channel MESSAGE			
Start Date	20 OCT 97			
Start Time	03:08:40 PM			
	CH1	CH1	CH1	
	VOLUM	+TOTL	SNDSP	
HH:MM:SS	ACF/HR	ACF	FT/S	
03:08:40 P	686.85	218.92	1039.147	
03:08:50 P	666.71	220.83	1039.003	
03:09:00 P	662.28	222.70	1039.511	
03:09:10 P	675.59	224.84	1039.509	
03:09:20 P	669.79	226.71	1039.470	
03:09:30 P	675.99	228.58	1039.137	
03:09:40 P	670.70	230.45	1039.105	
03:09:50 P	684.00	232.57	1039.082	
03:10:00 P	680.58	234.46	1039.255	
03:10:10 P	678.12	236.34	1038.860	
.	.	.	.	
.	.	.	.	

Figure 4-1: A Typical Numeric Printout

Graphical Format

To print live data in graphical format, continue as follows:

8. Use the [←], [→] and [F1]-[F4] keys to select the first parameter to be printed. See Table 4-2 on the next page for a list of the available options.

Graphical Format (cont.)

Table 4-2: Measurement Parameter Options

Option Bar Choice	Description
[F1] = VEL	Flow Velocity
[F2] = VOLUM	Volumetric Flow
[F3] = +TOTL	Forward Totalized Volume Flow
[F4] = -TOTL	Reverse Totalized Volume Flow
[→] + [F1] = MDOT	Mass Flow
[→] + [F2] = +MASS	Forward Totalized Mass Flow
[→] + [F3] = -MASS	Reverse Totalized Mass Flow
[→] + [F4] = DIAG	Diagnostic

Refer to Chapter 3, *Diagnostics*, of the *Service Manual* for a discussion of the many parameters accessible using the DIAG option.

Note: *The units assigned to the parameters in Table 4-2 above are those selected in the User Program (SYSTM submenu).*

9. Enter the desired maximum value for the Y (vertical) axis and press [ENT].

Note: *Enter a Y AXIS MAX value that is larger than the largest expected measurement value.*

10. At the Y Range prompt, press [F1] to show only the positive Y axis or press [F2] to display both the positive and negative y axis.

11. Use the [←], [→] and [F1]-[F4] keys to select the desired *Time Increment* (the frequency at which measurements are taken). The available options are: 5sec, 10sec, 30sec, 1min, 3min, 6min and 12min.

After the time increment is chosen, the Model GF868 returns to the standard data display screen and continues to take measurements. The live data is printed at the specified time intervals, until a STOP command is issued (see the instructions for the STOP submenu). A portion of a typical printout is shown in Figure 4-2 below.

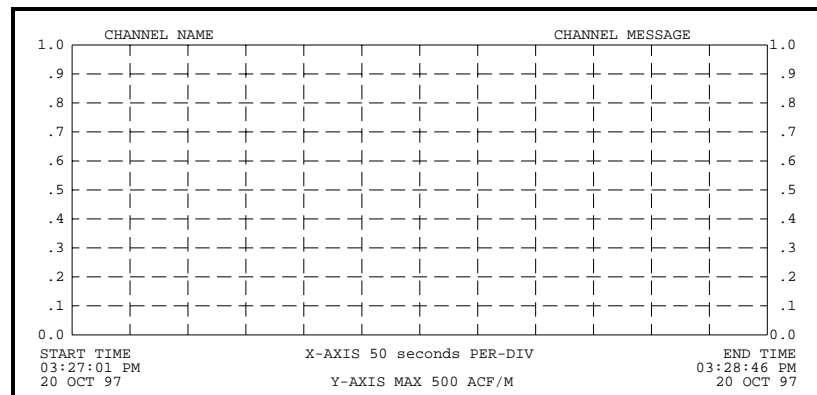

Figure 4-2: A Typical Graphical Printout

Printing Logs

Use the LOG submenu to print logged measurement data, from a log file in the meter's memory. The data may be printed in either numeric or graphical format, with a user specified time increment.

IMPORTANT: *Make sure that a printer has been properly set up before proceeding with this section.*

To print logged measurement data, refer to Figure A-5 on page A-5, and complete the following steps:

1. To access the *Print Menu*, press the [PRNT] key.

Note: *The Print Menu is not protected by the security feature and a password is never required to access this menu.*

2. Press [F2] = LOG.

3. At the *Format* prompt, press [F1] to print the log in numeric format or press [F2] to print the log in graphical format.

4. Use the [←], [→] and [F1]-[F4] keys to select a log file to print.

Note: *At the NAME prompt, the option bar shows the names of all completed or active log files currently stored in memory. If an active log is selected for printing, only the data already accumulated at the time of the print command will be printed.*

5. Enter the number of the *First Page* of the log to print and press [ENT]. (This prompt does not appear if the log file is only one page long.)

6. Enter the total number of log *pages* to print and press [ENT]. (This prompt does not appear if the log file is only one page long.)

- If you chose [F1] (Numeric) at step 3, see the section below.
- If you chose [F2] (Graphic) at step 3, go to the next page.

Numeric Format

After the numeric format (and starting page and number of pages, if applicable) is chosen, the Model GF868 returns to the standard data display screen and begins printing the log file. The printout continues until the entire log has been printed or until a STOP command is issued (see the instructions for the STOP submenu). A portion of a typical printout is shown in Figure 4-3 below.

LOG DUMP			
LOG NAME	Page# 1		
LOG MESSAGE			
Start Date	09 SEP 97		
Start Time	11:50:43 AM		
End Date	09 SEP 97		
End Time	11:54:45 PM		
	Ch1	Ch1	Ch2
	VOLUM	+TOTL	SNDSP
HH:MM:SS	ACF/HR	ACF	FT/S
11:50:45 A	686.85	218.92	1039.147
11:50:55 A	666.71	220.83	1039.003

Figure 4-3: A Typical Numeric Printout

Graphical Format

After the graphical format (and starting page and number of pages, if applicable) is chosen, complete the following additional steps:

7. Enter the desired maximum value for the Y (vertical) axis and press [ENT].

Note: *Enter a Y AXIS MAX value that is larger than the largest logged measurement value.*

8. At the Y Range prompt, press [F1] to show only the positive Y axis or press [F2] to display both the positive and negative y axis.

The Model GF868 returns to the standard data display screen and begins printing the log file. The printout continues until the entire log has been printed or until a STOP command is issued (see the instructions for the STOP submenu). A portion of a typical printout is shown in Figure 4-4 below.

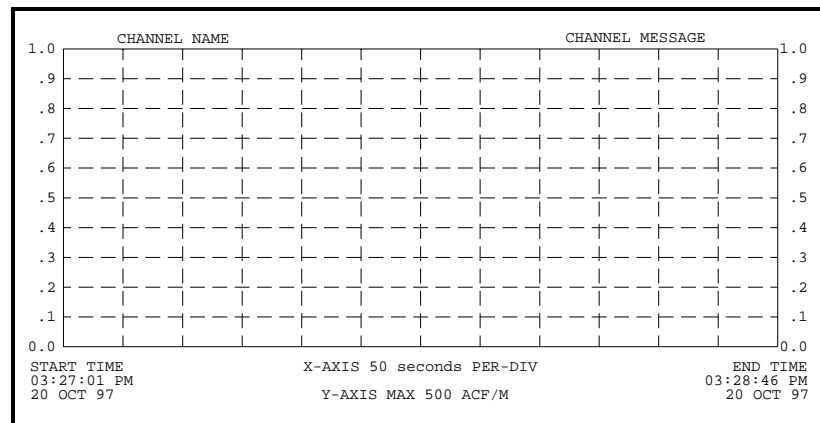

Figure 4-4: A Typical Graphical Printout

Print Site File

Use the PROG submenu to print the data in a site file that was set up and saved as described in Chapter 1, *Programming Site Data*. To print a site file, refer to Figure A-5 on page A-5 and complete the following steps:

IMPORTANT: *Make sure that a printer has been properly set up before proceeding with this section.*

1. To access the *Print Menu*, press the [PRNT] key.

Note: *The Print Menu is not protected by the security feature and a password is never required to access this menu.*

2. Press [F3] = PROG.

3. Use the [←], [→] and [F1]-[F4] keys to select the desired *Site File* to print.

Note: *All site files currently in memory appear on the option bar. The active site file is always listed as the first choice (Work).*

The Model GF868 returns to the standard data display screen and generates a site file printout similar to the one shown in Figure 4-5 below. The printout continues until the entire file has been printed or until a STOP command is issued (see the instructions for the STOP submenu on the next page).

```

PROGRAM PARAMETERS of SITE NAME
Model GF868 GF3G
With 1K FIFO and 1113 receiver board.
At 9:54:39 AM on 11 FEB 99

ACTIVE PARAMETERS:

Site status          Burst
Skan/measure mode   Skan Only

SYSTEM PARAMETERS:

no LABEL            No MESSAGE
System Units        ENGLISH
Totalizer Option    Automatic
Volumetric Units    Thousands ACF
Volumetric Time     /min
VOL Decimal Digits  0
Totalizer Units     Actual cubic ft
TOT Decimal Digits  0
Mass Flow Units     Pounds
MDOT Decimal Digits 0
Mass Units          Pounds
Mass Decimal Digits 0

PIPE PARAMETERS:

Transducer number   81
Pipe OD              12.000 inches
Pipe Wall            0.200 inches
Path Length         16.97 inches
Axial Dimension L   12.00 inches
Multi K-factors     OFF
Calibration Factor  1.000

```

Figure 4-5: A Typical Site File Printout

Stop Printing

Use the STOP submenu to terminate the printing of live, logged or site data. To stop any active printing activity, see Figure A-5 on page A-5, and complete the following steps:

IMPORTANT: *Make sure that a printer has been properly set up before proceeding with this section.*

1. To access the *Print Menu*, press the [PRNT] key.

Note: *The Print Menu is not protected by the security feature and a password is never required to access this menu.*

2. Press [F4] = STOP.

3. Press [F1] to continue printing or press [F2] to *Stop* the currently active printing job.

Note: *After the STOP command has been issued, the printer will complete the printing of any data already in the printer buffer. Either wait for the printer to finish or turn the printer off to empty the buffer immediately.*

The Model GF868 returns to the standard data display screen and normal measurement taking.

Setting Up a Printer

Use the PRNTR submenu to specify the type of printer connected to the Model GF868. To set up a printer, refer to Figure A-5 on page A-5, and complete the following steps:

IMPORTANT: *A printer must be properly set up before proceeding to any of the other sections in this chapter*

1. To access the *Print Menu*, press the [PRNT] key.

Note: *The Print Menu is not protected by the security feature and a password is never required to access this menu.*

2. Press the [←] or [→] key to display the option bar shown, and then press [F1] to select the PRNTR submenu.
3. Use the [←], [→] and [F1]-[F4] keys to select the desired *Printer Type*. See Table 4-3 below for a complete list of the available options.

Note: *For compatibility with the Model GF868, the printer must have an RS232 serial interface. To use a printer with a parallel interface, a serial-to-parallel adapter must be used.*

Table 4-3: Available Printer Options

Key(s)	Printer Type	Description
[F1]	DP411	Seiko Model DPU-411 Type II
[F2]	XTECH	Extech Mini Serial Printer 42
[F3]	EPSON	Epson or Epson-compatible
[F4]	KODAK	Kodak Diconix 150 Plus
[→]+[F1]	SP401	Syntest SP-401

After the desired printer type has been selected, the meter returns to the standard data display screen and normal measurement taking.

Printing Signal Array Data

Use the SGNLS submenu to print signal array data, to help diagnose certain problems. To print the signal data, see Figure A-5 on page A-5 and complete the following steps:

IMPORTANT: *Make sure that a printer has been properly set up before proceeding with this section.*

1. To access the *Print Menu*, press the [PRNT] key.

Note: *The Print Menu is not protected by the security feature and a password is never required to access this menu.*

2. Press the [←] or [→] key to display the option bar shown, and then press [F2] to select the SGNLS submenu.

3. Press the [F1]-[F3] keys to select the desired *Signal Array* data to print. To abort the procedure, press the [EXIT] key.

Note: *The SIGNAL option causes the raw signal array data to print, while the CROSS option causes the cross-correlation data to print. The BOTH option prints both sets of data.*

After the desired print selection has been made, the Model GF868 returns to the standard data display screen and normal measurement taking. The specified signal array data is printed continuously, until it is manually stopped. To terminate signal array printing, use the STOP submenu, as described earlier in this chapter. A portion of a typical printout is shown in Figure 4-6 below.

CH1	SKAN	SIGNAL
0	0	0
1	0	0
2	0	0
.		
.		
757	40	44
758	41	45
759	40	42
760	34	34
761	32	34
762	36	38
763	36	36
.		
.		
.		

Figure 4-6: A Typical Signal Array Printout

Printing Signal Array Data (cont.)

The data printed using the SIGNAL submenu consists of 1024 lines, each of which lists the following three values:

- **Index** - this is the printout line number, which locates the data point within the complete body of data.
- **Upstream** - this is the amplitude of the signal from the upstream transducer at the listed index number.
- **Downstream** - this is the amplitude of the signal from the downstream transducer at the listed index number.

Note: *The printouts generated from the CROSS and BOTH submenus will appear after the SIGNAL printout, as separate listings.*

The data printed in this array permits a comparison of the relative signal strengths of the upstream and downstream transducers, which are used to calculate a single flow measurement.

Printing RTD Data

Use the RTDs submenu to send the numeric point value of a connected RTD device to the RS232 port for display on a terminal or RS232 printer. By viewing the point value of the meter at a given temperature, you can calculate the points at the Set Temperature, and the slope of the RTD input in points/degree. (See Chapter 1, *Calibration*, of the *Service Manual* for more details.)

1. To access the *Print Menu*, press the [PRNT] key.

Note: *The Print Menu is not protected by the security feature and a password is never required to access this menu.*

2. Press the [←] or [→] key to display the option bar shown, and then press [F3] to select the RTDs submenu.
3. At the *Dump RTD Data* prompt, press [F1] to leave the PRINT menu without dumping data, or [F2] to send the RTD data to the RS232 port.

After the selection has been made, the Model GF868 returns to the standard data display screen and normal measurement taking. If you have selected YES at the DUMP RTD DATA prompt, the meter continues to send data until you reenter the PRINT menu and select the STOP option.

Chapter 5

Clearing Data

Introduction.....	5-1
Reset Totals.....	5-2
Deleting Site Files.....	5-3
Deleting Log Files.....	5-4

Introduction

This chapter explains how to purge the Model GF868's memory of various measurement totals and/or files. The *Clear Menu*, which is accessed by pressing the [CLR] key on the keypad, is divided into three submenus:

- TOTAL - used to reset totalized measurement values
- SITE - used to remove site parameter files from memory
- LOG - used to clear log files from memory.

Note: *For detailed information on creating a log file, see Chapter 3, Logging Data. For detailed information on creating a site file and for setting up the stopwatch totalizer, see Chapter 1, Programming Site Data.*

For purposes of this discussion it is assumed that the left pane of the data display screen is active. If the right pane of the data display screen is active, all of the instructions remain the same, except that any references to the [F1]-[F4] keys should be replaced by the [F5]-[F8] keys.

IMPORTANT: *None of the clearing procedures available using the Clear Menu can be undone. Be very sure that the exact consequences of a selected option are thoroughly understood before proceeding.*

Refer to Figure A-6 on page A-6, and proceed to the desired section for detailed instructions. Each submenu may be followed in the sequence shown or the [↑] and [↓] keys may be used to scroll through the prompts.

Reset Totals

The TOTAL submenu permits the user to reset volumetric totals to zero and to reset the stopwatch totalizer. Press the appropriate side of the [SCREEN] key to activate the desired pane of the display screen, and complete the following steps:

1. To access the *Clear Menu*, press the [CLR] key.
 - a. If you have activated the security feature (see Chapter 1, *Programming Site Data*, page 1-41 for details), enter the assigned password and press [ENT].
2. Press [F1] = TOTAL.
3. Press [F1] to abort the procedure or press [F2] to clear all volumetric totals and reset the stopwatch totalizer. In either case, the initial *Clear Menu* prompt returns.

Procedure Options

Do one of the following:

- Press [F1]-[F3] to enter one of the CLR submenus.
- Press the [EXIT] key to return to the data measurement display.

Deleting Site Files

Use the SITE submenu to clear site files from the GF868's memory. Use the [SCREEN] key to activate the desired display pane, and complete the following steps:

1. To access the *Clear Menu*, press the [CLR] key.
 - a. If you have activated the security feature (see Chapter 1, *Programming Site Data*, page 1-41 for details), enter the assigned password and press [ENT].
2. Press [F2] = SITE.
3. At the *Site Name* prompt, use the [←], [→] and [F1]-[F4] keys to select a site file for deletion. To leave the SITE submenu, press the [EXIT] key.

Note: *At the Site Name prompt, the option bar shows the names of all site files currently stored in memory.*

4. Press [F1] to abort the procedure or press [F2] to *Clear* the specified site file. If any site files remain in memory, the *Site Name* prompt repeats.

When all of the stored site files have been cleared or the [EXIT] key has been pressed at the SITE NAME prompt, the programming sequence resumes at this point.

Procedure Options

Do one of the following:

- Press [F1]-[F3] to enter one of the CLR submenus.
- Press the [EXIT] key to return to the data measurement display.

Deleting Log Files

Use the LOG submenu to clear log files from the Model GF868's memory. Press the appropriate side of the [SCREEN] key to activate the desired pane of the data display screen, and complete the following steps:

1. To access the *Clear Menu*, press the [CLR] key.
 - a. If you have activated the security feature (see Chapter 1, *Programming Site Data*, page 1-41 for details), enter the assigned password and press [ENT].
2. Press [F3] = LOG.
3. At the *Name* prompt, the option bar shows the names of all log files currently stored in memory. Use the [←], [→] and [F1]-[F4] keys to select a log file for deletion. To leave the LOG submenu, press the [EXIT] key.
4. Press [F1] to abort the procedure or press [F2] to *Clear* the specified log file. If any log files remain in memory, the *Name* prompt repeats.

When all of the stored log files have been cleared or the [EXIT] key has been pressed at the *Name* prompt, the programming sequence resumes at this point.

Procedure Options

Do one of the following:

- Press [F1]-[F3] to enter one of the CLR submenus.
- Press the [EXIT] key to return to the data measurement display.

Chapter 6

Serial Communications

Introduction.....	6-1
Wiring the RS232 Interface	6-1
Checking the GF868 Baud Rate.....	6-2
Setting Up the Terminal Software and Transferring Data	6-2
The Optional RS485 Serial Interface	6-5
Setting Up an Ethernet Connection	6-10

Introduction

The Model GF868 flowmeter is equipped with a standard RS232 serial interface. By using this interface, any log files stored in the GF868's memory may be easily uploaded to a personal computer. In order to accomplish this, the following steps must be completed:

- Connect the GF868 to the personal computer
- Check the GF868 baud rate setting
- Set up the personal computer's terminal software
- Transfer the log files to the personal computer.

This section also contains instructions for setting up an RS485 serial interface.

Wiring the RS232 Interface

The first step is to connect the built-in RS232 port in the GF868 to one of the serial ports (COM1 or COM2) on the personal computer. Table 6-1 below lists the standard cables available from the factory for this purpose.

Table 6-1: GE Serial Cables

Part Number	PC Connector	GF868 Connector
704-659	DB-25 Male	Flying Leads (5)
704-660	DB-9 Male	Flying Leads (5)
704-661	DB-25 Female	Flying Leads (5)
704-662	DB-9 Female	Flying Leads (5)

Each of the cables listed in Table 6-1 above is available in several standard lengths. However, a user-supplied cable may be used, if preferred. In either case, wire the GF868 end of the serial cable in accordance with the pin designations listed in Table 6-2 below.

Table 6-2: RS232 Pin Connections

GF868 Pin #	GE Cable Color	DB-25 Cable Pin #	DB-9 Cable Pin #
1 (RTN)	Green	7	5
2 (TX)	Black	3	2
3 (RX)	Red	2	3
4 (DTR)	White	20	4
5 (CTS)	Yellow	5	8

Note: For basic serial communications between a single GF868 and a personal computer, no connections are required to pins 4 and 5 of the GF868's serial connector. However, these pins should be jumpered together to ensure proper operation.

Checking the GF868 Baud Rate

For successful serial communications, the GF868 and the personal computer must be set up to send/receive data at the same speed. To verify or change the *baud rate* setting of the GF868, proceed as follows:

Access the *User Program*, by pressing the [PROG] key on the keypad. The standard measurement mode screen will be replaced by the following initial programming mode screen:

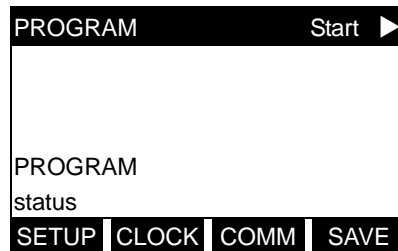

Press the [←] and [→] keys and the [F3] key to select the COMM submenu.

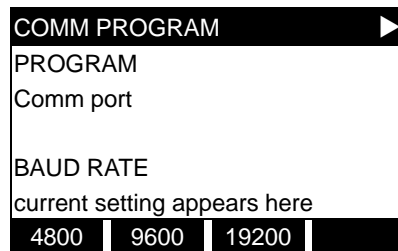

To change the baud rate, press the [→] key until the desired baud rate appears on the option bar, and then press the appropriate [F \times] function key.

The available rates are 300, 600, 1200, 2400, 4800, 9600 and 19200 baud. After verifying or changing the baud rate setting, press the [EXIT] key twice to return to standard measurement mode.

Note: *Refer to Chapter 1, Programming Site Data, for a detailed description of using the COMM submenu on page 1-33. The description includes information on checking UART bits and network ID.*

Setting Up the Terminal Software and Transferring Data

Specific instructions are given in this manual for communicating with personal computers running under either the Windows 3.X (page 6-3) or Windows 9X/NT (page 6-4) operating systems. Proceed to the appropriate section for detailed set up procedures.

Note: *For computers operating under other operating systems, contact the factory for assistance or consult the operating system manual supplied with the computer.*

Windows 3.X Systems

To set up serial communications with a personal computer running under Windows 3.X, make sure the GF868 is powered on and operating, and complete the following steps:

1. In Windows 3.X, select the Terminal Function, which is usually located in the Accessories window.
2. The Terminal Screen appears, with six menus located at the top of the screen. Using the Settings Menu, select the Communications option.
3. When the Communications Screen appears, make the following selections:
 - *Baud Rate* - set to the same value as the GF868 setting
 - *Data Bits* - 8
 - *Stop Bits* - 1
 - *Parity* - None
 - *Flow Control* - Xon/Xoff
 - *Connector* - select the correct communications port
 - *Parity Check* - not checked
 - *Carrier Detect* - not checked
4. Using the Transfer Menu, select the Receive Text File option.
5. A window appears asking for a file name. Select the desired directory and file name (with .prt extension) and then click on OK.
6. From the keypad on the GF868, enter the PRINT menu and select the log file to be uploaded to the computer in numeric format. See Chapter 4, *Printing Data*, for detailed instructions on this procedure.
7. The logged data will begin appearing on the computer screen. After the transfer has been completed, the uploaded file may be used in any software program, just like any other text file.

Note: *If the RS232 link does not function, switching the leads to pins 2 (TX) and 3(RX) at the RS232 connector on the meter often solves the problem.*

Windows 9X/NT Systems

Windows 9X/NT systems use a program called *Hyperterminal* to access the serial ports. To set up serial communications with a personal computer running under Windows 95, Windows 98 or Windows NT, make sure the GF868 is powered on and complete the following steps:

1. From the Windows START menu, select PROGRAMS>ACCESSORIES>HYPERTERMINAL>HYPERTERMINAL.
2. The NEW CONNECTION window should appear (if it does not, select it from the FILE menu). After entering the desired CONNECTION NAME and selecting an ICON, click on OK.
3. When the CONNECT TO window appears, select the serial communications port (COM1 or COM2) to which the GF868 is connected and click on OK.
4. When the COMx PROPERTIES window appears, make sure the settings are as follows:
 - Bits per Second: 9600 (must match the GF868 setting)
 - Data Bits: 8
 - Parity: None
 - Stop Bits: 1
 - Flow Control: Xon/Xoff

After making any necessary changes, click on OK.

5. Open the TRANSFER menu and select CAPTURE TEXT. Enter the desired DRIVE:\DIRECTORY\FILENAME for the file about to be transmitted, and click on OK.
6. From the keypad on the GF868, enter the PRINT menu and select the log file to be uploaded to the computer in numeric format. See Chapter 4, *Printing Data*, for detailed instructions on this procedure.
7. The logged data will begin appearing on the computer screen. When the transfer has been completed, open the TRANSFER menu and select CAPTURE TEXT>STOP. The uploaded file may now be used in any software program, just like any other text file.

Note: *If the RS232 link does not function, switching the leads to pins 2 (TX) and 3(RX) at the RS232 connector on the meter often solves the problem.*

Point-To-Point Wiring

Standard factory wiring of the RS485 serial interface is configured for point-to-point wiring. That is, a single Model GF868 may be wired directly to a single personal computer. To connect the RS485 serial interface, refer to Figure 6-1 on page 6-5 and complete the following steps:

Note: *For compliance with the European Union's Low Voltage Directive (73/23/EEC), a transparent plastic shroud protects the electrical connections. The shroud must remain in place, except while wiring the unit. Reinstall the shroud after the wiring has been completed.*

1. Disconnect the *main power* to the electronics console and open the cover.

!WARNING!

Dangerous voltages exist within the electronics console. Do not perform any wiring operations until the main power to the unit has been disconnected.

2. Remove the clear plastic *shroud* that covers the electrical connectors.
3. Using a *twisted-wire pair*, connect the XMT+ terminal of the barrier strip to the T+/R+ terminal of the PC's RS485 adapter and connect the XMT- terminal of the barrier strip to the T-/R-terminal of the PC's RS485 adapter (see the documentation provided with the RS485 adapter for details).

Note: *The XMT+ terminal on the barrier strip is the screw opposite the red wire connection and the XMT- terminal on the barrier strip is the screw opposite the green wire connection.*

4. Reinstall the clear plastic shroud, close the cover to the electronics console and reconnect the main power.

The RS485 serial interface is now ready for point-to-point operation. However, the installed version of the Model GF868 software must be *Version 3G* or higher to support RS485 operation. If necessary, contact the factory for information about a software upgrade.

Multi-Point Wiring

The standard point-to-point wiring configuration for the serial interface converter may be modified to permit the use of a multi-point wiring arrangement. In a multi-point RS485 system, one flowmeter (the master) is connected to the personal computer, while a number of additional flowmeters (the slaves) are chained together and connected to the master flowmeter. In order to implement such a system, the DIP switch settings inside each serial interface converter must be changed.

IMPORTANT: *The serial interface converter in the last slave unit in the chain should not be reconfigured.*

Reconfiguring a Serial Interface Converter

To reconfigure a serial interface converter for multi-point wiring, complete the following steps:

1. Disconnect the *main power* to the electronics console and open the cover.

!WARNING!

Dangerous voltages exist within the electronics console. Do not perform any wiring operations until the main power to the unit has been disconnected.

2. Remove the clear plastic *shroud* that covers the electrical connectors.
3. Remove the serial interface converter *mounting bracket* by removing the standoff located just below the RS232 terminal block and the grounding screw on its left (see Figure 6-1 on page 6-5).
4. Loosen the two screws that fasten the DB9 connector to the mounting bracket, and remove the *serial interface converter* from the bracket.
5. Use a small screwdriver to pry open the *plastic case* of the serial interface converter, as shown in Figure 6-2 on page 6-8.

The serial interface converter contains a main printed circuit board and a daughter printed circuit board. The daughter board has a small terminal block attached to it and the main board has a DIP switch (SW1) mounted near the center of the board.

6. Locate the switch assembly on the main board, and move the switch in position 1 from ON to OFF. The standard ON state for this switch is for point-to-point operation, while the OFF state is needed for multi-point operation. See Table 6-3 on page 6-8 for the proper settings of all four switches on the switch assembly.

Reconfiguring a Serial Interface Converter (cont.)

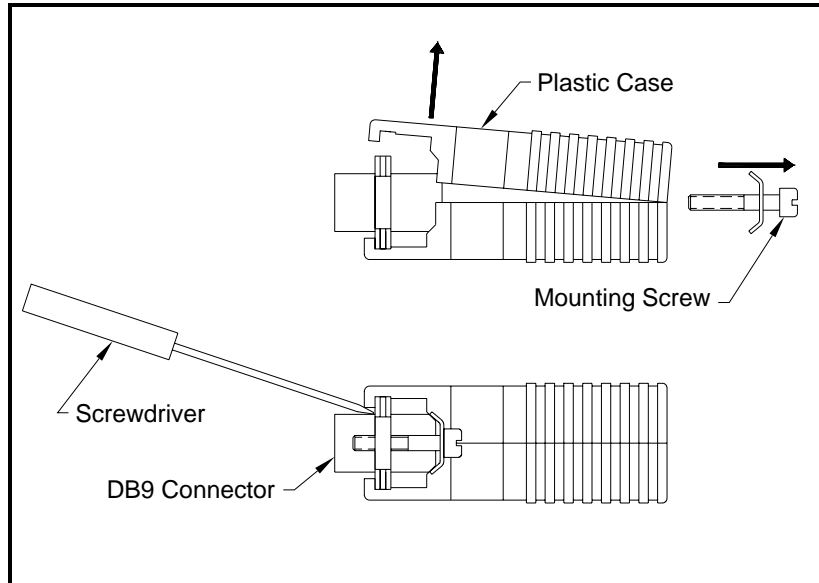

Figure 6-2: Opening the Converter Case

Table 6-3: Switch Assembly Settings

Position #	Point-To-Point	Multi-Point
1	ON	OFF
2	ON	ON
3	ON	ON
4	OFF	OFF

7. Reassemble the serial interface converter and secure it to the mounting bracket with the two mounting screws.
8. Reinstall the mounting bracket into the electronics enclosure and secure it with the standoff and the grounding screw.

Wiring the System

After the serial interface converters have been configured for multi-point operation, the system can be wired.

1. Using *twisted-wire pairs*, connect the XMT+ terminals of all the flowmeters together and connect the XMT– terminals of all the flowmeters together.

IMPORTANT: *Make sure that the flowmeter with the non-modified converter is wired as the last unit in the chain.*

2. Using a *twisted-wire pair*, connect the XMT+ terminal of the barrier strip to the T+/R+ terminal of the PC's RS485 adapter and connect the XMT– terminal of the barrier strip to the T-/R– terminal of the PC's 485 adapter (see the documentation provided with the RS485 adapter for details).

Note: *The XMT+ terminal on the barrier strip is the screw opposite the red wire connection and the XMT– terminal on the barrier strip is the screw opposite the green wire connection.*

3. Reinstall the clear plastic shroud, close the cover to the electronics console and reconnect the main power.

The RS485 serial interface is now ready for multi-point operation. However, the installed version of the Model GF868 software must be *Version 3G* or higher to support RS485 operation. If necessary, contact the factory for information about a software upgrade.

Setting Up an Ethernet Connection

A modified GF868 can use the Ethernet interface to communicate with an internal network. An optional Ethernet card with a unique MAC (IP) address (installed only in slots 5 or 6) includes an RJ45 connector. To connect the Ethernet-enabled GF868 to the network, insert the jack of an RJ45 cable into the RJ45 connector, route the cable through the bottom of the GF868, and wire the other end of the cable to the LAN according to the manufacturer's instructions.

To establish Ethernet communications with the GF868, you must install the Ethernet Device Discovery software utility (available with your modified GF868) on a PC connected to the LAN. Once installed and running, the software displays all Ethernet devices currently connected to the subnet. You can identify the GF868 by its MAC address, supplied as part of customer documentation. The default IP Port is 2101.

The default IP addressing for the GF868 is DHCP (dynamic). If you need to assign a static IP address to the GF868, complete the following steps:

IMPORTANT: *To assign a static IP address, the GF868 must be connected to an Ethernet network with a dynamic address assignment mechanism (DHCP) first.*

1. Run Ethernet Device Discovery software, and identify the GF868's current IP address.
2. Open your Internet browser (Internet Explorer, Netscape, or other) and type the DF868 IP address in the Address box.
3. The Connect ME Configuration and Management window opens. Two text boxes ask for the user name and password.
 - a. In the Username text box, type root.
 - b. In the Password text box, type dbps.
4. At the left of the window, click on Network.
5. The IP Settings window opens. In the text boxes for IP Address, Subnet Mask, and Default Gateway, type in the new information.
6. Click Apply. The software applies the new address.

Setting Up a MODBUS/ TCP Connection

A modified GF868 can use the MODBUS/TCP interface to communicate with an internal network. An optional MODBUS/TCP card with a unique MAC (IP) address (installed only in slots 5 or 6) includes an RJ45 connector. To connect the MODBUS/TCP-enabled GF868 to the network, insert the jack of an RJ45 cable into the RJ45 connector, route the cable through the bottom of the GF868, and wire the other end of the cable to the LAN according to the manufacturer's instructions.

To establish MODBUS/TCP communications with the DF868, you must install the Ruiping software utility (available with your modified GF868) on a PC connected to the LAN. Once installed and running, the software displays all Ethernet devices currently connected to the subnet. You can identify the GF868 by its MAC address, supplied as part of customer documentation. The default TCP Port is 502.

The default IP addressing for the GF868 is DHCP (dynamic). If you need to assign a static IP address to the DF868, complete the following steps:

IMPORTANT: *To assign a static IP address, the GF868 must be connected to an Ethernet network with a dynamic address assignment mechanism (DHCP) first.*

1. Run Ruiping software, and identify the GF868's current IP address.

Note: *"Ruiping-e" will return the found IP addresses as well as the MAC address.*

2. From a DOS command prompt, type: telnet "ip address" 10000
3. The "Welcome to Net+Works Configuration Utility" opens. Type in the login name and password.
 - a. Login: type root.
 - b. Password: type Netsilicon.
4. In the Main Menu:
 - a. Select IP Parameters (1). Enter the desired IP changes and return to the Main Menu.
 - b. Select Enable DHCP Client (3). Select N (2) to disable, then select 4 for Main Menu.
5. At the Main Menu, select 4 for Quit. Power cycle the GF868 (i.e., turn the meter off and on) to apply the changes.

Appendix A

Menu Maps

ACTIV, SYSTM, and PIPE Menu Map	A-1
I/O Menu Map	A-2
PROG Menu Map	A-3
DISP Menu Map	A-4
PRNT Menu Map	A-5
LOG and CLR Menu Maps	A-6

NOTE: Plain text represents prompt area messages and boxed text represents option bar choices. Fx represent function keys to select option bar choices.

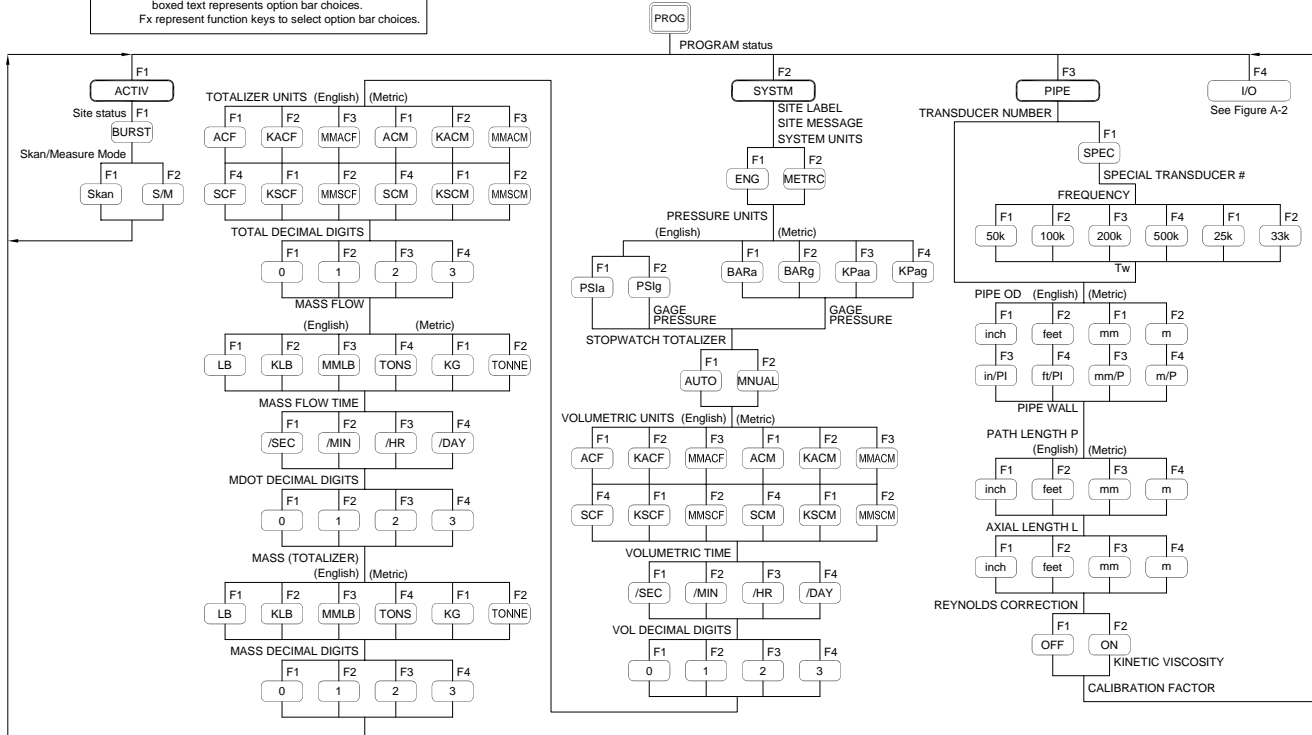

Figure A-1: ACTIV, SYSTEM, and PIPE Menu Map

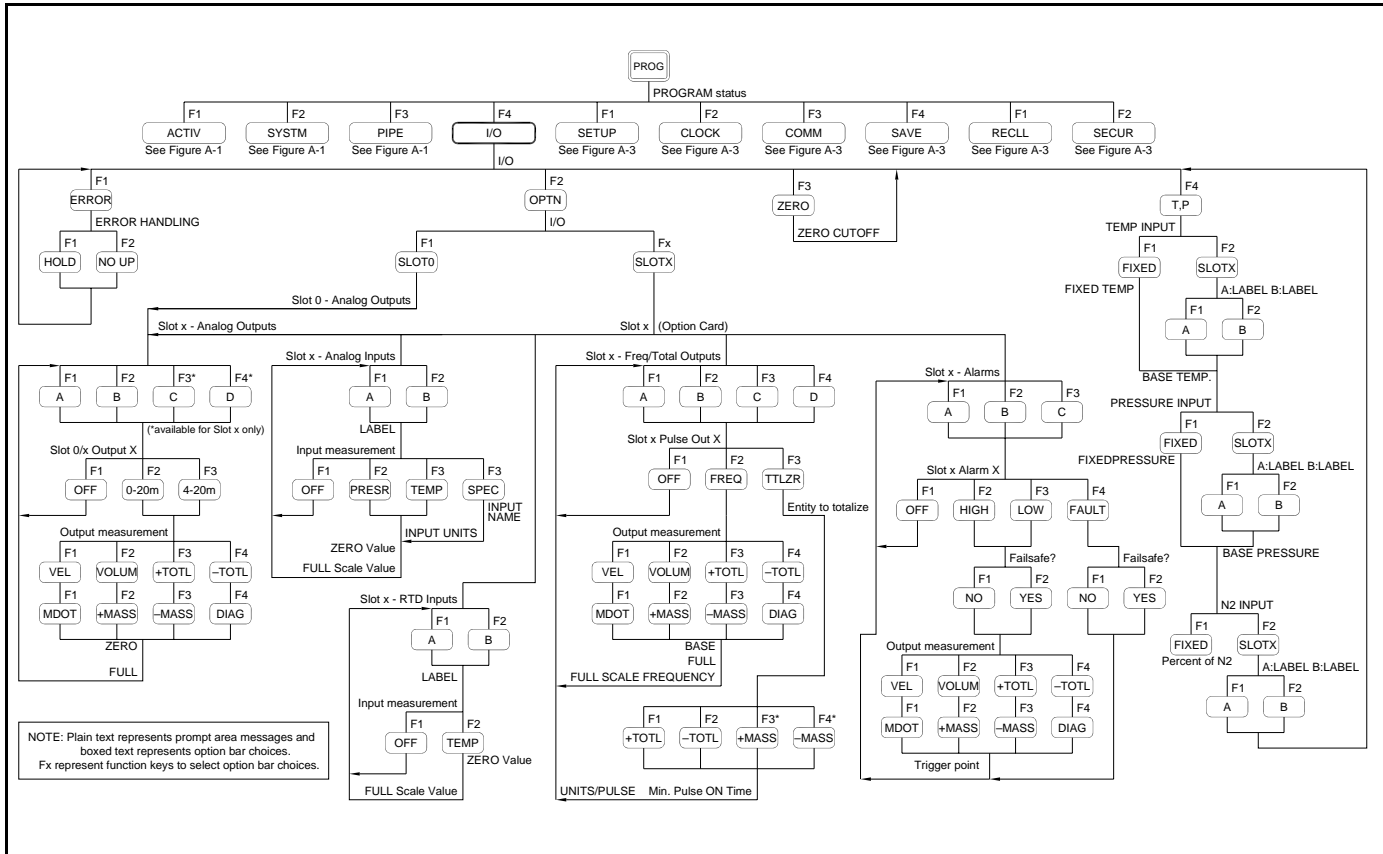

Figure A-2: I/O Menu Map

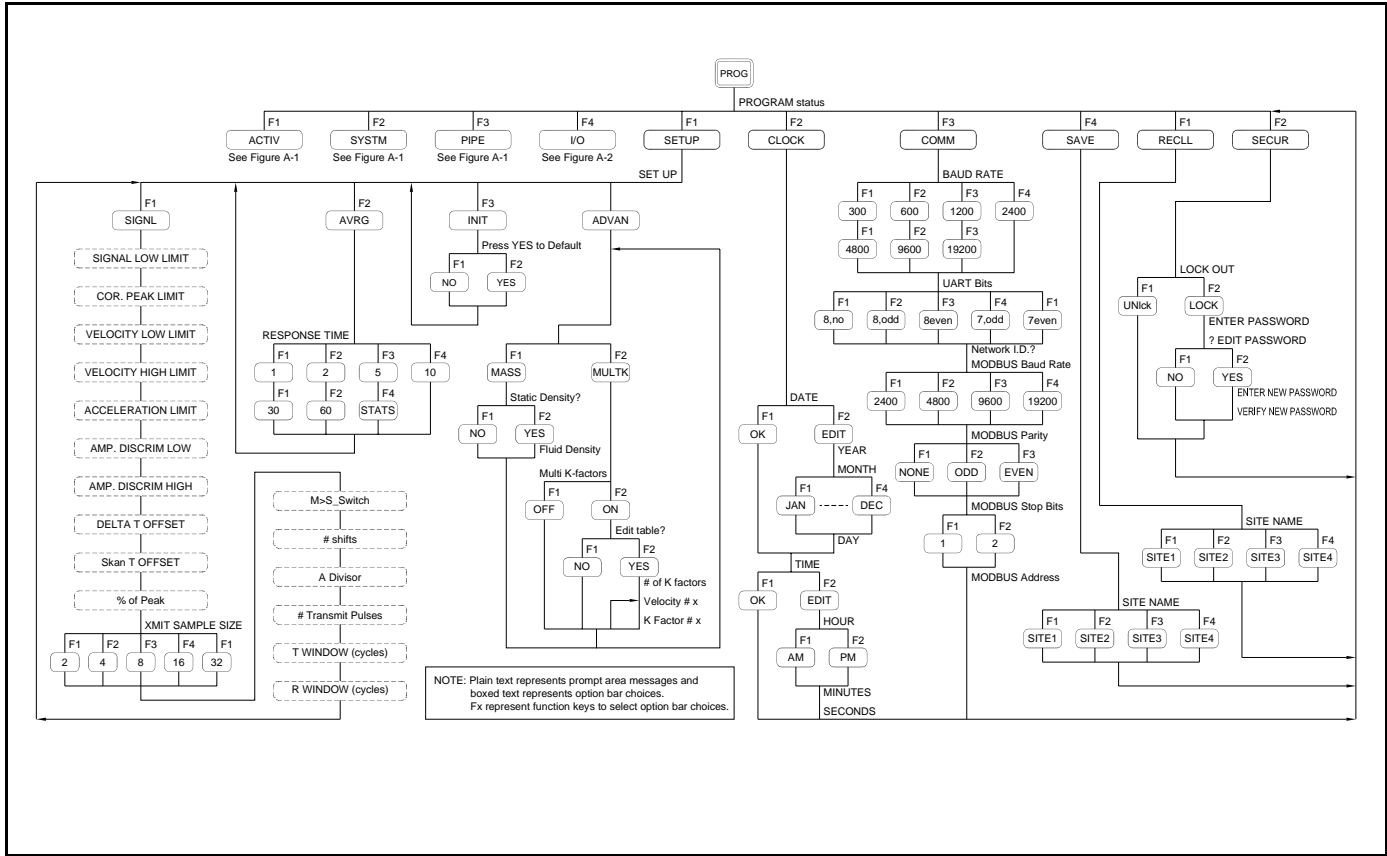

Figure A-3: PROG Menu Map

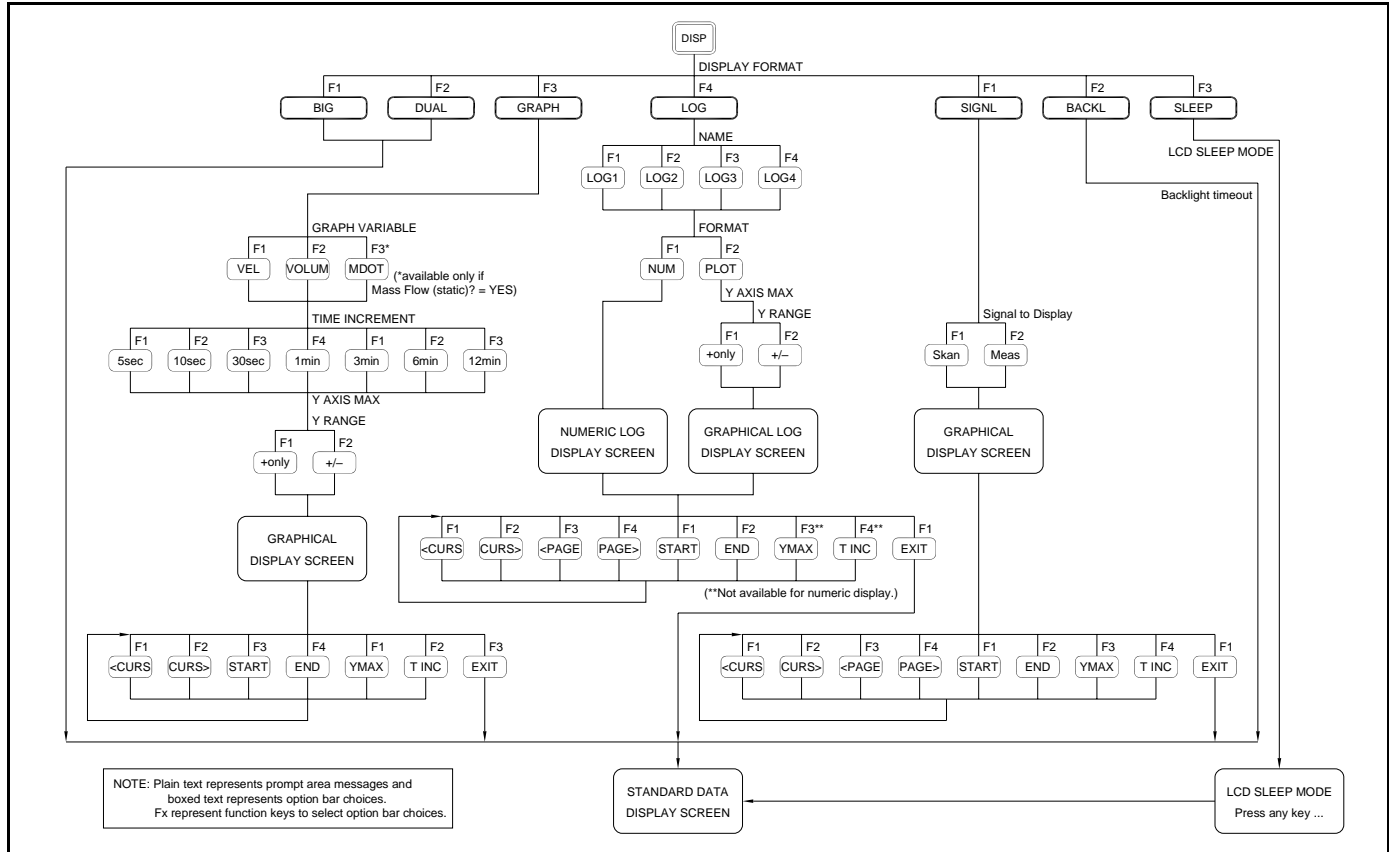

Figure A-4: DISP Menu Map

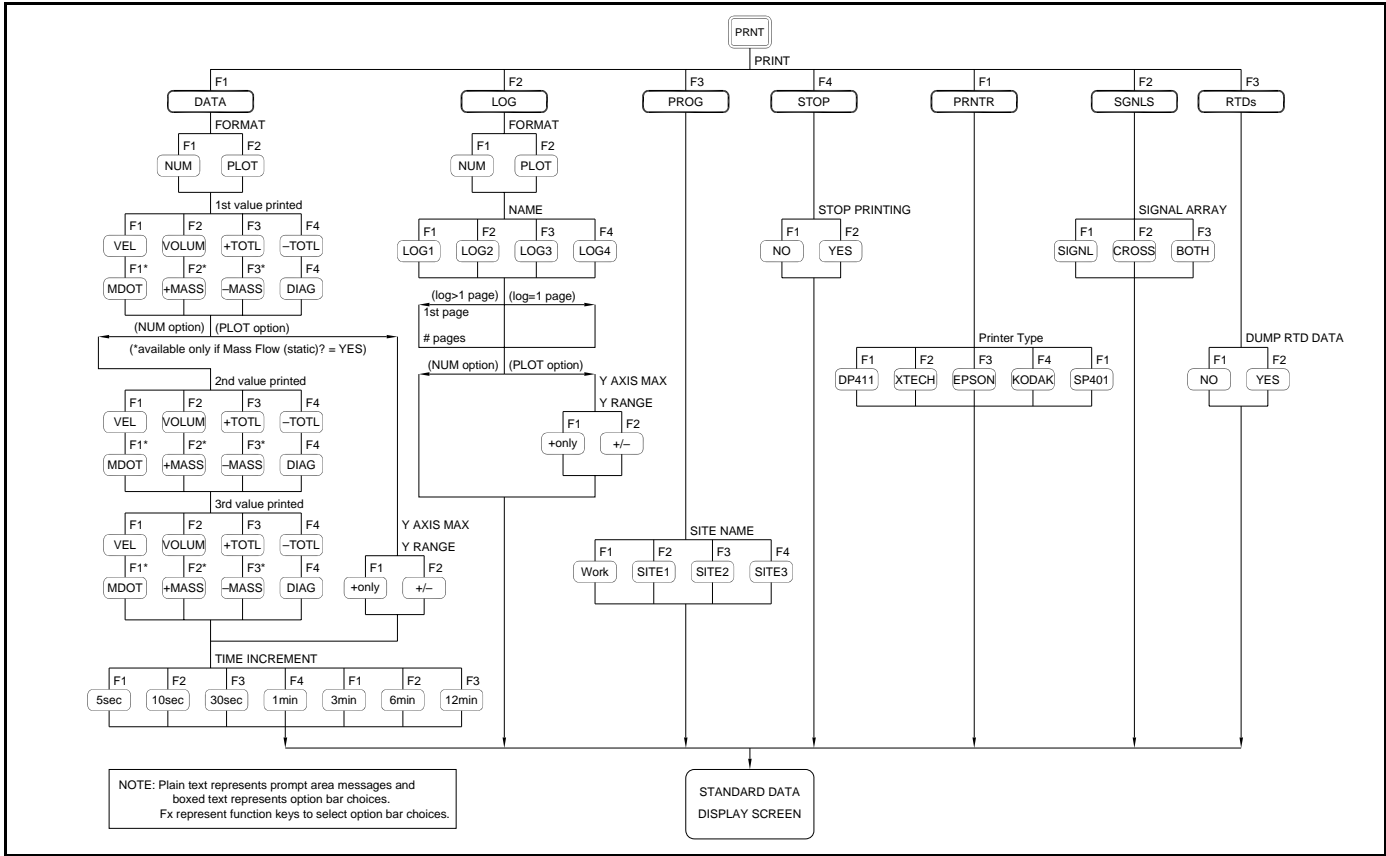

Figure A-5: PRINT Menu Map

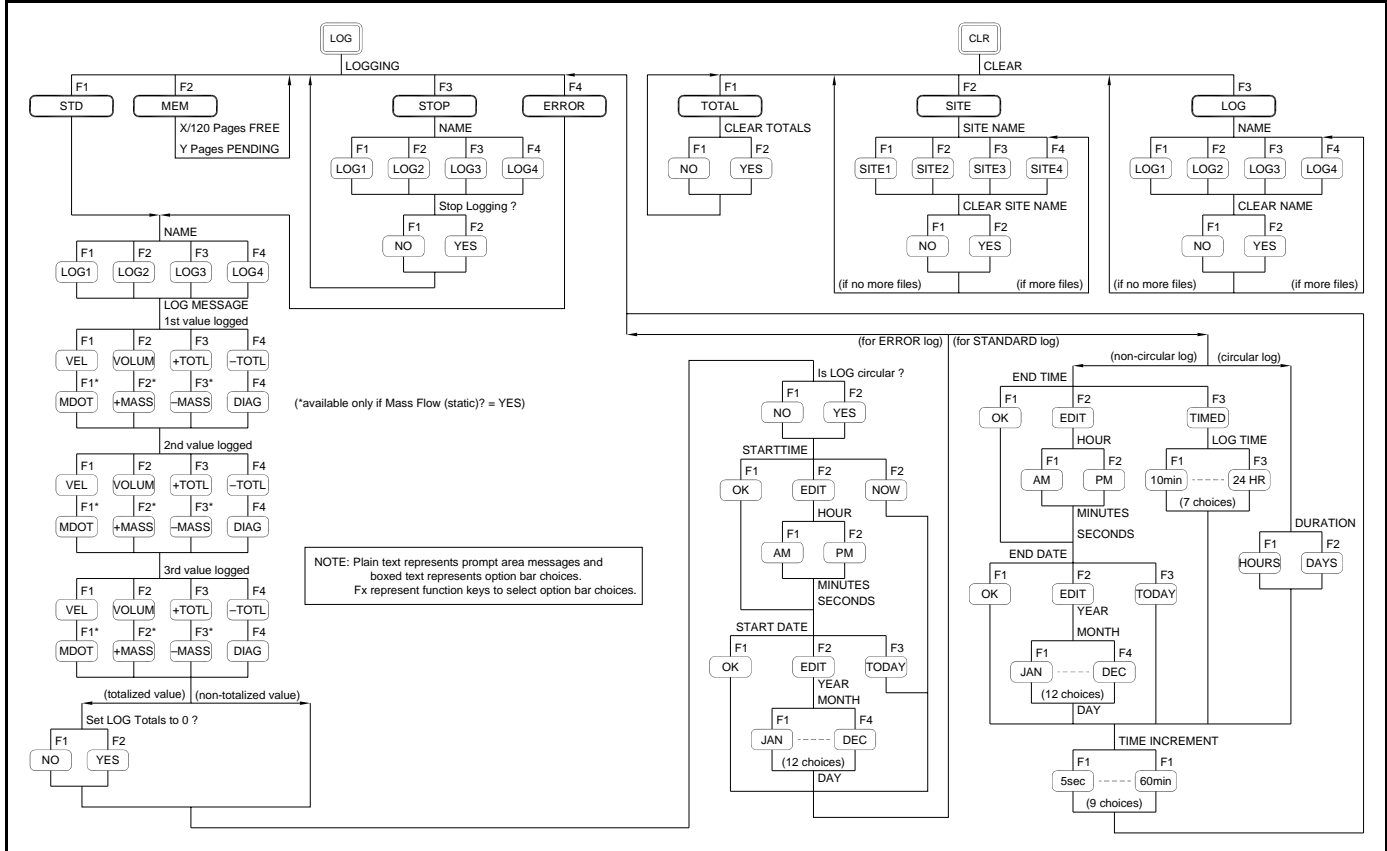

Figure A-6: LOG and CLR Menu Maps

Appendix B

Data Records

Option Cards InstalledB-1

Initial Setup DataB-2

Option Cards Installed

Whenever an option card is installed in one of the Model GF868's expansion slots, record the type of card and any additional setup information in the appropriate row of Table B-1 below.

Table B-1: Option Cards Installed

Slot #	Type of Option Card	Additional Setup Information
0	Analog Outputs (A, B)	
1		
2		
3		
4		
5		
6		

Initial Setup Data

After the Model GF868 flowmeter has been installed, some initial setup data must be entered using the *User Program*, prior to operation. Record that information in Table B-2 below.

Table B-2: Initial Setup Data

General Information						
Model #				Reference		
Software Vers.				Date		
Serial #				Z Dimension		
Measurement Method - <i>ACTIV</i>						
Site Status	Burst			Measure Mode	Skat	S/M
System Parameters - <i>SYSTEM</i>						
Site Label				Vol. Dec. Digits		
Site Message				Totalizer Units		
System Units	English	Metric		Tot. Dec. Digits		
Pressure Units				Mass Flow		
Gage Pressure				Mass Flow Time		
Stopwatch Total.	Auto	Manual		MDOT Dec. Dig.		
Vol. Units				Mass (TOT.)		
Vol. Time Units				Mass Dec. Dig.		
Pipe/Transducer Parameters - <i>PIPE</i>						
Trans. #				Reynolds Corr.	Off	On
Spec. Trans. Hz				Kin. Visc.		
Spec. Trans. Tw				Multi K Factors		
Pipe O.D.				Edit Table		
Pipe Wall				Cal. Factor		
Path Length (P)				Error Handling		
Axial Length (L)				Baud Rate		
				UART Bits		

K Factor Table						
K-Factor #	Velocity	K-Factor		K Factor #	Velocity	K-Factor
1				11		
2				12		
3				13		
4				14		
5				15		
6				16		
7				17		
8				18		
9				19		
10				20		

Appendix C

Programming with PanaView

- Introduction.....C-1
- Wiring the RS232 InterfaceC-1
- Setting Up the Communications PortC-2
- Adding the GF868.....C-5
- Editing Meter Properties.....C-7
- Changing Meter SettingsC-15

Introduction

The PanaView™ graphical user interface offers interactive communications between Windows-based PCs and GE instruments compatible with the company's IDM protocol, such as the GF868 ultrasonic gas flowmeter. PanaView is compatible with 32-bit Windows operating systems such as Windows 98SE, NT 4.0 (with Service Pack 6), 2000, XP and ME. With PanaView, you can:

- load and save site file data
- create and save graph and log files
- display text output and graphs of live measurement data
- create custom templates for displaying text, graph and log data
- interface with multiple GE instruments.

This document focuses on particular applications suitable for the GF868. For general PanaView applications such as creating graph and log files, displaying live measurement data, and creating custom templates, please refer to the general PanaView *User's Manual* (910-211).

Wiring the RS232 Interface

All IDM-protocol instruments utilize an RS232 interface to communicate with a PC. For details on wiring your RS232 interface, please refer to the *Installation* chapter of your instrument's User's Manual, and to the document *EIA-RS Serial Communications* (916-054).

Setting Up the Communications Port

Use the steps below to establish communications with the GF868.

1. Open the “*New Meter Browser*” window and expand the network tree. Then, highlight the *My Computer(Name)* branch by clicking on it.
2. Pull down the “*Edit*” menu by clicking on it in the menu bar.
3. Click on the “*New*” menu option to select it, and a submenu opens with two choices on it (see Figure C-1 below).

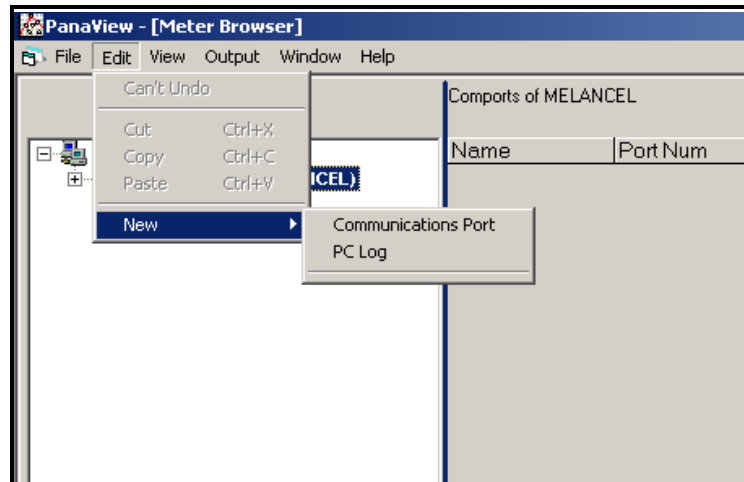

Figure C-1: The Edit Menu

Setting Up the Communications Port (cont.)

- Click on the “*Communications Port*” option to select it. The *Setup Communications* screen appears similar to Figure C-2 below.

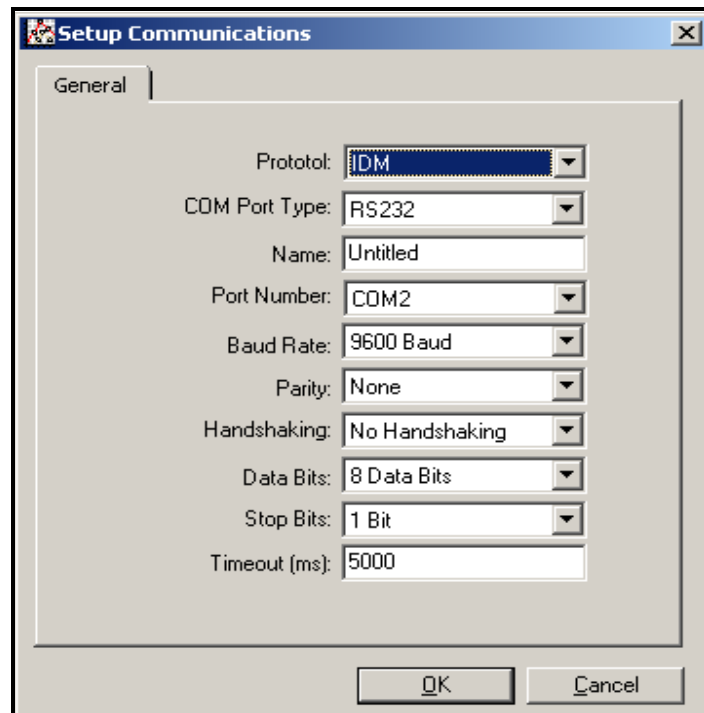

Figure C-2: Setup Communications Screen

- Open the Protocol menu (the first of the drop-down menus) and click on *IDM*.
- Open the COM Port Type menu and click on the desired type (or on *TCP/IP*, if the GF868 is using an Ethernet connection).

Note: *If you select TCP/IP, the menu changes. Proceed to the next page.*

- Select any suitable available baud rate. A baud rate of 19,200 is appropriate for almost all applications. However, if you experience periodic communication reliability problems, you may wish to consider lowering the baud rate on your instrument and in PanaView.

IMPORTANT: *Be sure all the communications port settings match those made in setting up the meter's serial port.*

- Click [OK] to complete data entry.

Setting up Ethernet
Communications

If you have selected TCP/IP in step 6 on the previous page, the Setup Communications window appears similar to Figure C-3 below.

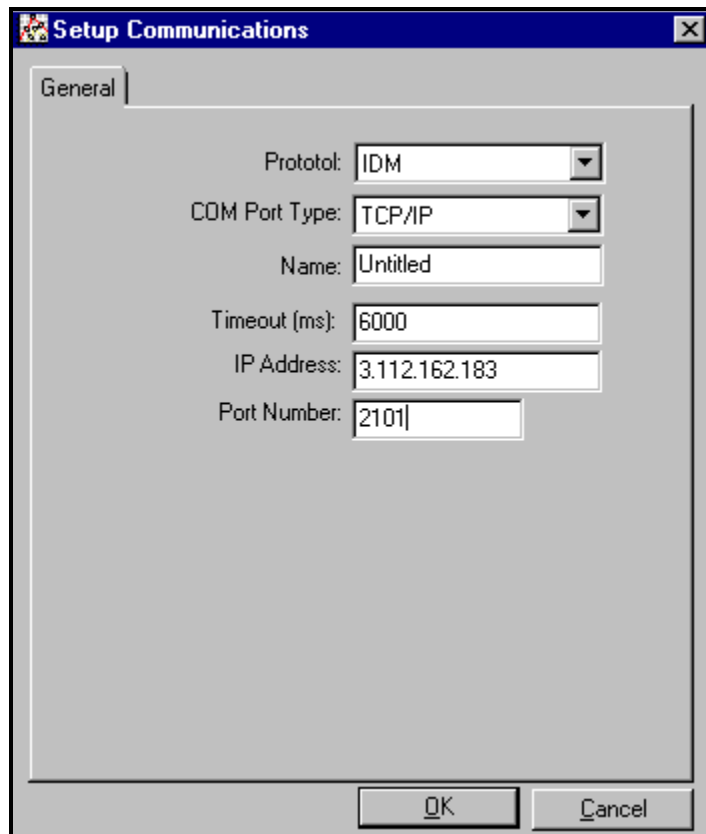

Figure C-3: Setup Communications for TCP/IP

7. Type in the desired *Name* and *Timeout* (in milliseconds).
8. In the *IP Address* text box, enter the IP address. If the IP address is unknown, run the Device Discovery software utility. All units found will be identified by their MAC address and the assigned IP address. In the *Port Number* box, enter 2101 (the default value).
9. Click [OK] to complete data entry.

IMPORTANT: *If you are using Ethernet communications, be sure the GF868 is set up with the default communications parameters: 9600 baud, no parity, no handshaking, 8 data bits and 1 stop bit. The port number must match the "Enable Raw TCP access using TCP Port" assignment shown under the Device Discovery "TCP Server Settings" menu (Configuration>Serial Ports>Port).*

Adding the GF868

To add the GF868 on the IDM-configured communications port, complete the following steps:

1. Highlight the communication port to which the meter will be added by clicking on it, and then open the “*Edit*” menu on the menu bar (if the communication port is not highlighted first, the “*New Meter*” option is not active in the “*Edit*” menu).
2. Click on the “*New*” option in the “*Edit*” menu (see Figure C-4 below).

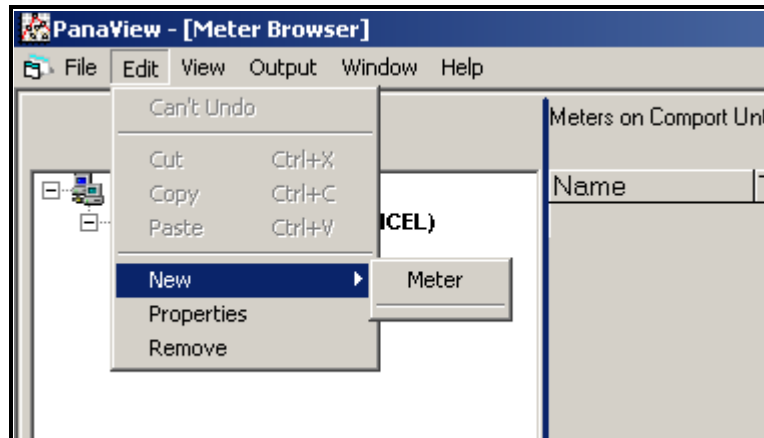

Figure C-4: “*New*” Option in the “*Edit*” Menu

3. After clicking on the “*New*” option, the “*Meter*” menu option appears. Click on this option to select it.
4. The “*New IDM Meter*” screen (shown in Figure C-5 below) opens. Enter the Network ID number for the meter, and click [OK].

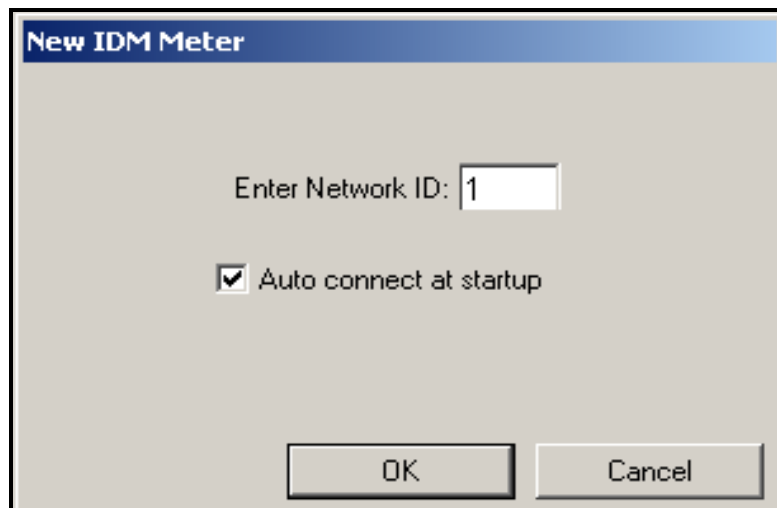

Figure C-5: New IDM Meter Screen

Adding the GF868 (cont.) **IMPORTANT:** *The Network ID number must match the Network ID programmed in the meter's Communications menu.*

If the initialization is successful, the Meter Browser shows a listing similar to Figure C-6 below.

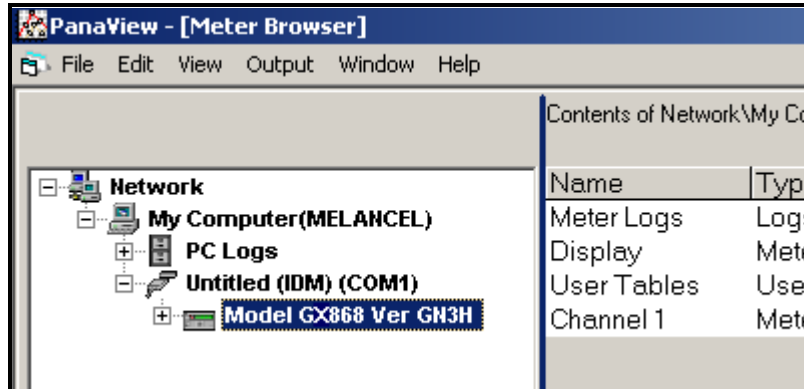

Figure C-6: The Updated Network Tree

Note: *The model number and version that appear will vary with your particular meter and software version.*

However, if the settings do not match, or there is some other difficulty, a screen appears similar to Figure C-7 below.

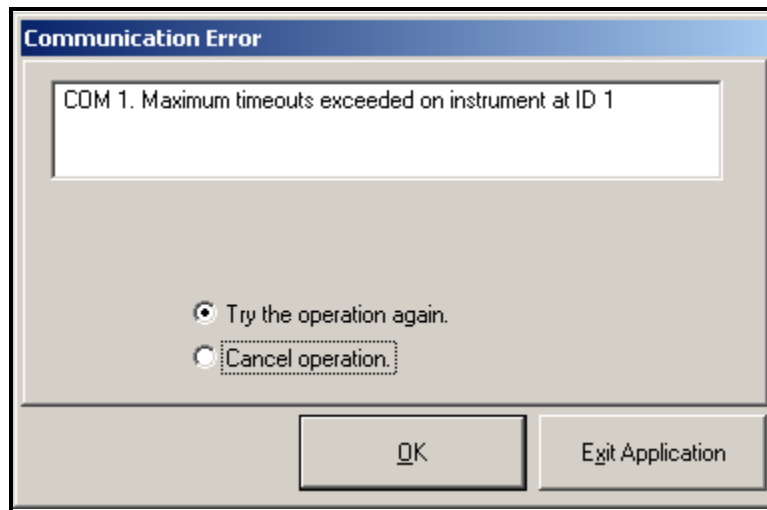

Figure C-7: Communication Error Screen

The screen offers the options of trying again or of canceling the operation. Click on the desired choice, and then on [OK] to confirm the choice or on [Exit Application] to close PanaView.

Note: *If you cannot resolve the problem, contact the factory for help.*

Editing Meter Properties

Through PanaView, you can edit the properties of your GF868. You can:

- Set the meter clock, or synchronize it with the PC clock
- Read, plot and save transducer signals
- Clear totalizers
- Save site files to the meter or PC
- Clear sites from the meter
- Print site files to the PC

To edit the properties of your GF868:

1. Highlight the meter (as shown in Figure C-6 on page C-6).
2. Open the “*Edit*” menu and select the “*Properties*” option, as shown in Figure C-8 below.

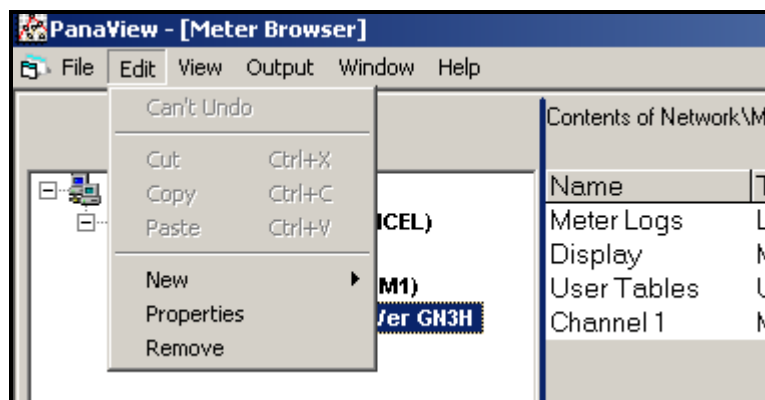

Figure C-8: The *Properties* Option in the *Edit* Menu

Editing Meter Properties (cont.)

The window appears similar to Figure C-9 below. To perform a specific task, refer to the appropriate section on the following pages.

- Setting the Meter Clock (page C-9)
- Reading Transducer Signals (page C-10)
- Plotting Transducer Signals (page C-10)
- Saving Transducer Signals (page C-11)
- Clearing Totalizers (page C-11)
- Handling Site Files (page C-12)

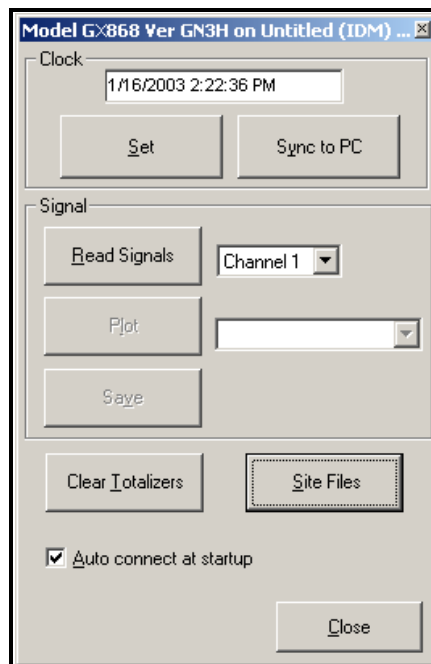

Figure C-9: Properties Window for IDM-Based Meter

Note: For illustration purposes, the meter shown here is a one-channel GX868 flowmeter. Specific parameters will vary with your particular meter.

Setting the Meter Clock

The meter's *Time* may be reset in three different ways:

- manually enter the time and date in the text box, or
- click on the [Sync to PC] option button to have PanaView set the time and date to the current PC setting, or
- click on the [Set] option button to open the dialog box shown in Figure C-10 below. Set the desired date and time as indicated, and click on the [OK] option button.



Figure C-10: Time and Date Selection Window

Reading Transducer
Signals

To read a *Signal* from the meter:

1. Click on the *Read Signals* button. (If the meter is a multi-channel instrument, open the Channel drop-down menu and click on the desired channel.) After a moment, the *Properties* window appears similar to Figure C-11 below.

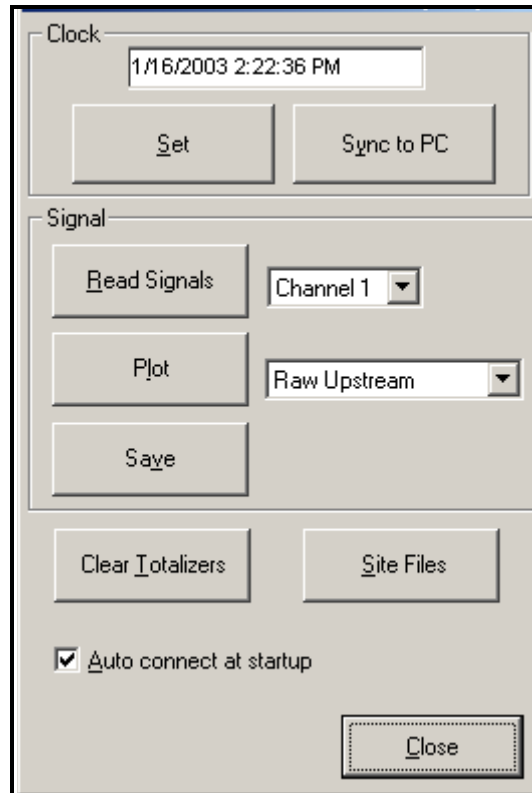

Figure C-11: Active Signal Options

2. To select a different signal type, open the signal menu at the right (shown here with *Raw Upstream* highlighted) and click on the desired signal.

Plotting Transducer Signals

To *plot* the selected signal, click on *Plot*. A graphical window opens, as shown in Figure C-12 below.

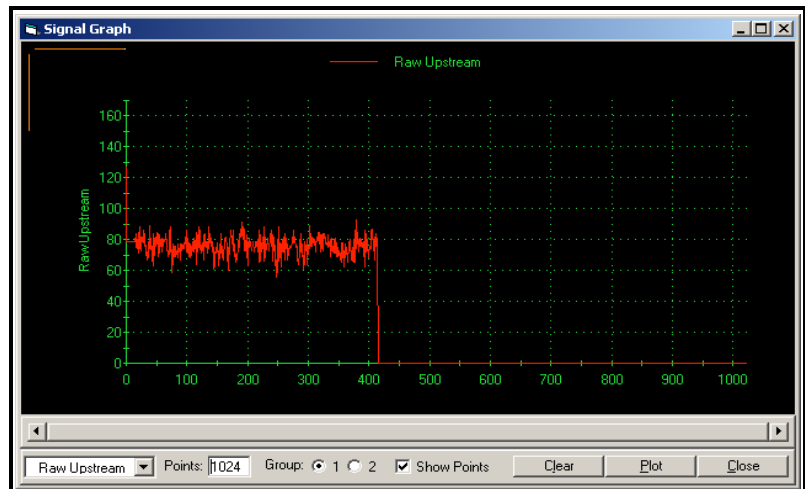

Figure C-12: Signal Graph Window

Saving Transducer Signals

To *save* the raw signal, click *Save*. A window opens similar to Figure C-13 below. Enter the desired name, and click *Save* to save the signal as a text file.

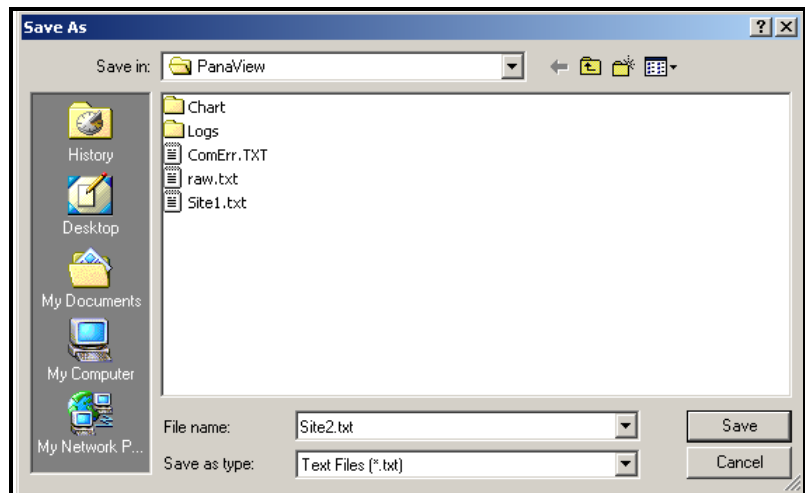

Figure C-13: Save As Window

Clearing Totalizers

To clear the meter totalizers, click on the *Clear Totalizers* button in the *Properties* window. The meter totalizers are reset to 0.

Handling Site Files

To access site files, click on the *Site Files* button in the *Properties* window. The *Site File Operations* window (shown in Figure C-14 below) opens.

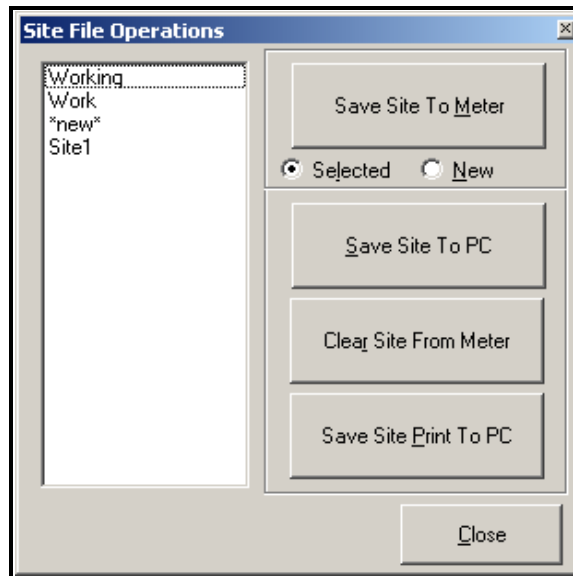

Figure C-14: The *Site File Operations* Window

Saving an Existing Site to the Meter

To save an existing site to the meter:

1. Select the radio button for *Selected* and highlight an existing site in the left pane.
2. Then click on the *Save Site to Meter* button. A screen opens similar to Figure C-15 below.

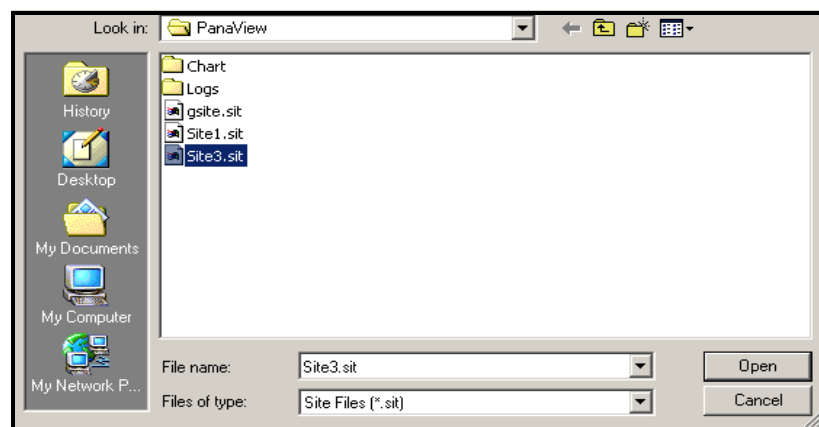

Figure C-15: Site File Selection

3. Highlight the desired site and click *Open*. PanaView sends the site to the meter.

Saving a New Site to the Meter

To save a new site to the meter:

1. Select the radio button for *New* and click on the *Save Site to Meter* button.
2. A window opens similar to Figure C-16 below. Enter the desired name, and click [OK].

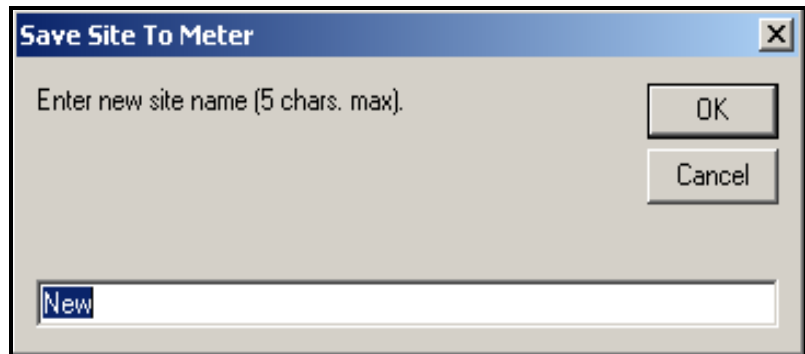

Figure C-16: Site Name Entry Window

3. The *Site File Selection* window (Figure C-15 on page C-12) opens. Highlight a site with the desired settings, and click [Open]. PanaView saves the site in the meter with the new name and the desired settings.

Saving a Site to the PC

To save a site to the PC:

1. Highlight the desired site in the left pane. (See Figure C-14 on page C-12.)
2. Click *Save Site to PC*. A window opens similar to Figure C-13 on page C-11.
3. Enter the desired site name and click [Save]. PanaView saves the site in the PanaView folder unless otherwise specified.

Note: *If you have created a site on the meter after opening the Site File Operations window, you must close and reopen the window to click on the new site.*

Clearing a Site from the Meter

To clear a site from the meter:

1. Highlight the site in the left pane. (See Figure C-14 on page C-12.)
2. Click *Clear Site From Meter*.
3. The program asks for confirmation. Click [OK]. The meter deletes the designated file.

Saving a Site in Text Form

To store the data from a site file as a text file for display or printout:

1. Highlight the site in the left pane. (See Figure C-14 on page C-12.)
2. Click *Save Site Print to PC*.
3. The *Site File Selection* window (Figure C-15 on page C-12) opens. Enter the desired site name (now with a .prt suffix) and click [Save]. PanaView displays a text version of the site, as shown in Figure C-17 below.

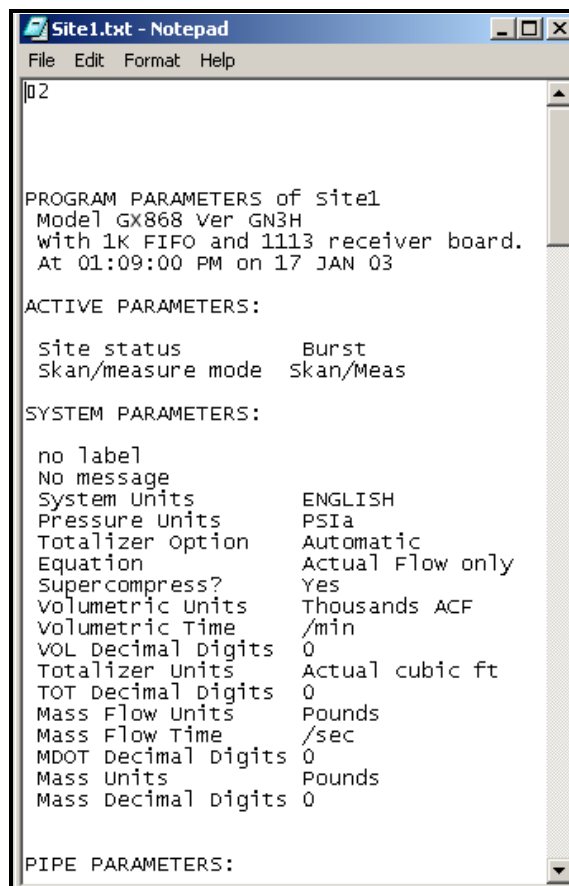

```

Site1.txt - Notepad
File Edit Format Help
|02

PROGRAM PARAMETERS of Site1
Model GX868 Ver GN3H
with 1K FIFO and 1113 receiver board.
At 01:09:00 PM on 17 JAN 03

ACTIVE PARAMETERS:

Site status          Burst
Skon/measure mode   Skon/Meas

SYSTEM PARAMETERS:

no label
No message
System Units        ENGLISH
Pressure Units      PSia
Totalizer option    Automatic
Equation            Actual Flow only
Supercompress?     Yes
Volumetric Units    Thousands ACF
Volumetric Time     /min
VOL Decimal Digits 0
Totalizer units     Actual cubic ft
TOT Decimal Digits 0
Mass Flow Units     Pounds
Mass Flow Time      /sec
MDOT Decimal Digits 0
Mass Units          Pounds
Mass Decimal Digits 0

PIPE PARAMETERS:

```

Figure C-17: Printout of Site File

4. Click [Close] once to close the *Site File Operations* window, and a second time to close the *Properties* window and return to the *Meter Browser*.

Changing Meter Settings Through PanaView, GF868 users can handle remote programming of the meter. They can:

- Program and change a meter's operating parameters;
- Set up, start, and stop logs;
- Calibrate and test inputs and outputs;
- Clear various files.

To access meter programming:

1. Enter the *New Meter Browser* option from the “File” menu.
2. Expand the network tree until you reach the desired meter.
3. Then expand the meter tree as shown in Figure C-18 below.

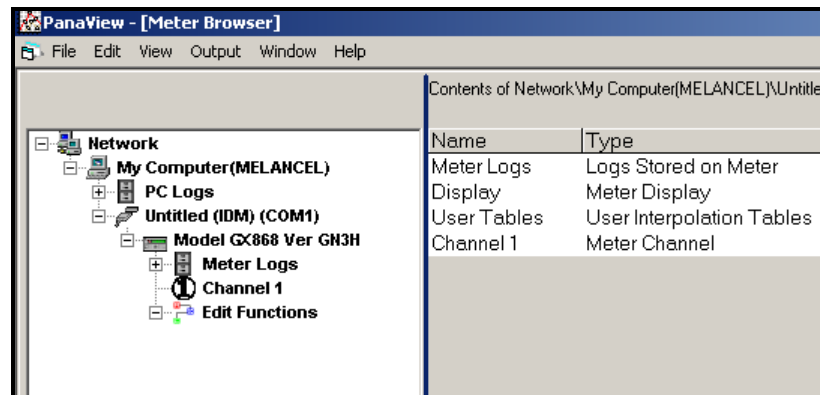

Figure C-18: *New Meter Browser* with Meter Branch

Changing Meter Settings (cont.)

- From the meter tree, expand the *Edit Functions* option. The window now appears similar to Figure C-19 below, with a list of available menus. The menus listed are those available on the meter.

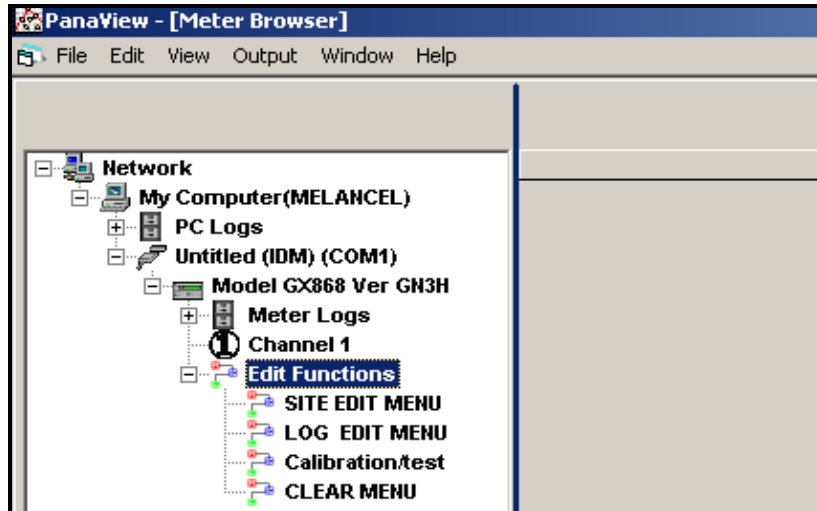

Figure C-19: Meter Tree with *Edit Functions* Option

- To open a particular menu, double-click on that menu on the tree. For example, if you double-click on the Site Edit Menu, a window opens similar to Figure C-20 below.

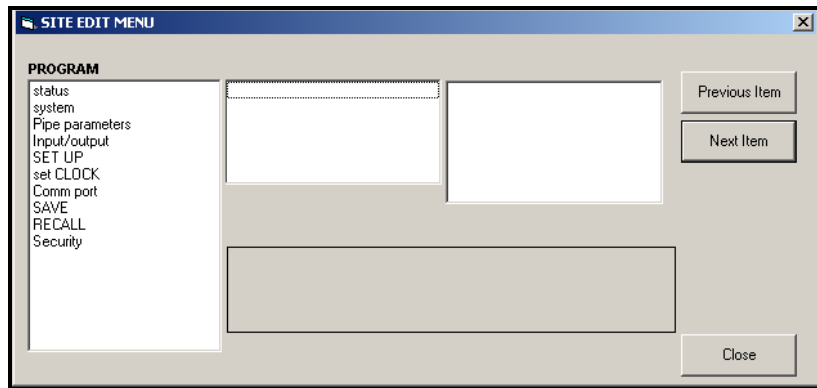

Figure C-20: The *Site Edit Menu* Window

Note: *The options listed in the left pane correspond to the options available in the GX868 PROGRAM menus. For more information about the options in your instrument program and about appropriate parameters for the GF868, consult the previous chapters in this manual.*

Changing Meter Settings (cont.)

6. To enter a particular option:
 - a. Highlight and double-click on the desired option in the left pane. Figure C-21 below shows the first entry (Transducer Number) in the *Pipe parameters* option. The title above the center pane lists the current entry, while the center pane displays the available selections for that entry.
 - b. Click on the desired choice; if the entry requires a numeric value, change the value displayed in the right pane.

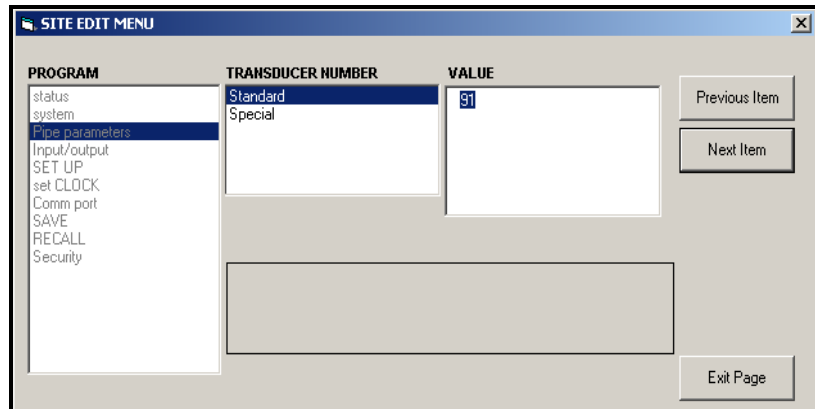

Figure C-21: Pipe Parameters Option in Site Edit Menu

- c. Do one of the following:

Click on [Next Item] to proceed to the next menu item,

or

Click on [Previous Item] to return back through the menu to a previous item.

Note: *If you click on either [Next Item] or [Previous Item] without changing the settings, the current settings remain unchanged.*

As you step through the menu, the bottom panel lists the current settings you have modified or left unchanged (see Figure C-22 on page C-18). If you modify or step through more than five items, a scroll bar at the right of the panel lets you review the earlier settings.

Changing Meter Settings (cont.)

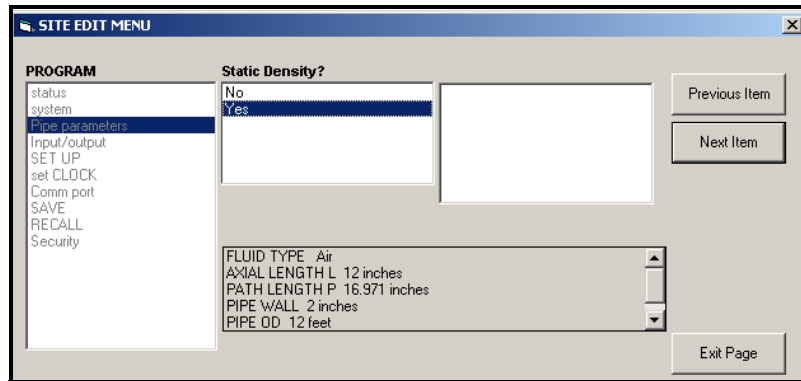

Figure C-22: Site Edit Menu with Current Settings

7. When you have completed entering parameters in a given option, click [Exit Page] to close the option. You can then double-click on another option, or click [Close] to close the window.

You can double-click on another menu to modify its settings, or return to the *New Meter Browser*. For additional PanaView functions, refer to the *PanaView User's Manual*.

Appendix D

Foundation Fieldbus Communications

- Optional MeasurementsD-1
- Configuration Utility SetupD-2
- Selecting the Desired MeasurementsD-2
- Selecting Units for AI BlocksD-4
- Resetting Instrument TotalizersD-5
- Function Block Application.....D-6

Optional Measurements Foundation Fieldbus provides a means of communicating with the flowmeter. The patent numbers which apply are 5,909,363 and 6,424,872.

This Foundation Fieldbus device supports 2 Analog Input (AI) blocks, which can be configured to supply the following measurements on the network (see Table D-1 below).

Table D-1: Available Measurements Using a Foundation Fieldbus Device

Channel 1	Units	Channel 1	Units	Channel 1	Units
Ch1 Velocity	ft/s or m/s*	Ch1 Mass Flow	MASS_U	Ch1 SSUP	none
Ch1 Act Volumetric	VOL_U	Ch1 Fwd Mass Totals	MTOT_U	Ch1 SSDN	none
Ch1 Std Volumetric	VOL_U	Ch1 Rev Mass Totals	MTOT_U	Ch1 Sound Speed	ft/s or m/s*
Ch1 Fwd Totals	TOT_U	Ch1 #Mass Tot Digits	none	Ch1 Density***	see note
Ch1 Rev Totals	TOT_U	Ch1 Timer	sec	Ch1 Temperature	Deg F or C*
Ch1 #Tot Digits**	none	Ch1 Error Code	none	Ch1 Pressure	PRESS_U

*Metric or English units are determined by the setup of the flowmeter.
 **Totalizer digits are available for informational purposes only. Respective totals are automatically scaled by the Tot Digits value selected in the flowmeter setup.
 ***If the meter is outputting Mole Weight, the unit is "mw", otherwise it is the programmed pressure unit.
 VOL_U, TOT_U, MASS_U, MTOT_U and PRESS_U are determined by the units chosen for these measurements in the flowmeter setup. See the instrument User's Manual for the setup of these parameters.

Configuration Utility Setup

The following is an example setup using National Instruments Configuration Utility v3.1.

Figure D-1 below shows the Configuration Utility with a flowmeter on the network (GE Flow-XMT).

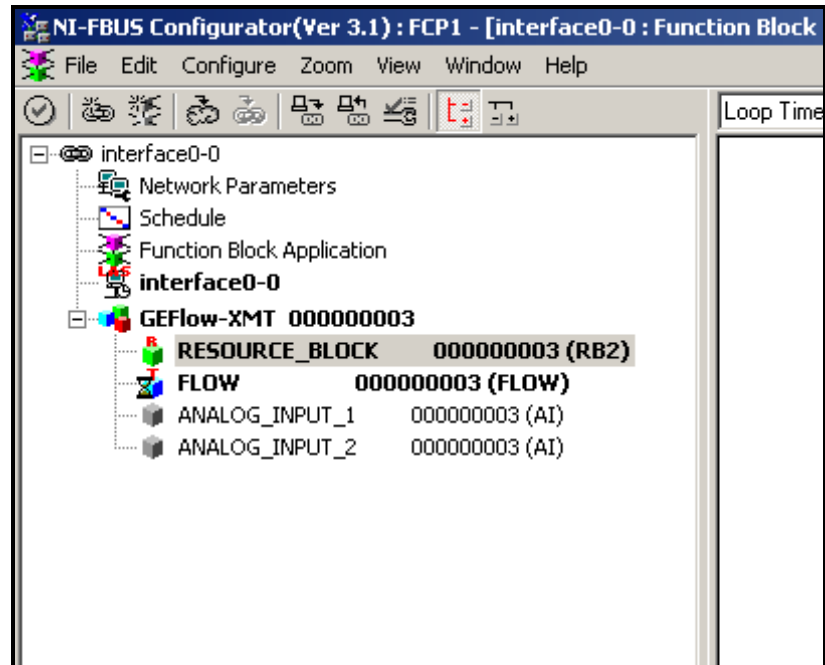

Figure D-1: Configuration Utility Setup Example

Note: *The following procedures assume that the device has been placed in the OOS (out-of-service) mode before executing.*

Selecting the Desired Measurements

To set the measurement unit for each AI:

1. Double click on the FLOW Transducer Block (in the tree under GEFlow-XMT).
2. Select the **Others** tab and open the drop down list for the PRIMARY_SELECTOR and SECONDARY_SELECTOR (refer to Figure D-2 on page D-3).
3. Choose the unit from the list (see Figure D-2 on page D-3).

This unit will correspond to the unit that is available in the AI block for network connection. The PRIMARY_SELECTOR unit will correspond to ANALOG_INPUT_1 and the SECONDARY_SELECTOR will correspond to ANALOG_INPUT_2.

Selecting the Desired Measurements (cont.)

4. After the desired measurements have been selected for the PRIMARY and SECONDARY SELECTOR, choose the unit system (UNIT_SELECTOR above the PRIMARY_SELECTOR) that has been programmed in the flowmeter (English or SI).

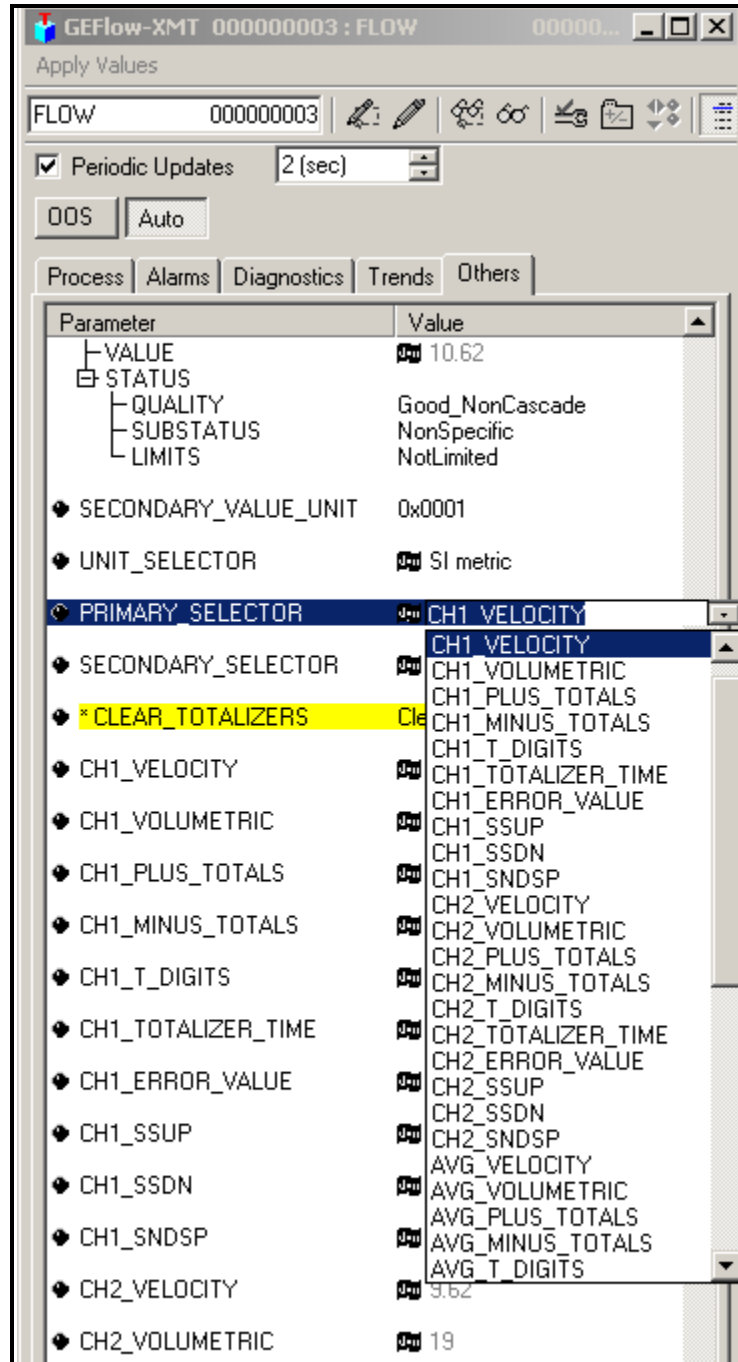

Figure D-2: Primary Selector Drop Down List

Selecting Units for AI Blocks

To select the units for the individual AI blocks:

1. Double click on the AI block for which you wish to set the units (ANALOG_INPUT_1 or ANALOG_INPUT_2 in the tree under GEFlow-XMT; see Figure D-1 on page D-2).
2. Select the **Scaling** tab and set the unit for the measurement based on the flowmeter settings.

For example, if the flowmeter was set to use the metric unit system and the PRIMARY_SELECTOR was set to use VELOCITY you would choose **m/s** for the unit as shown in Figure D-3 below.

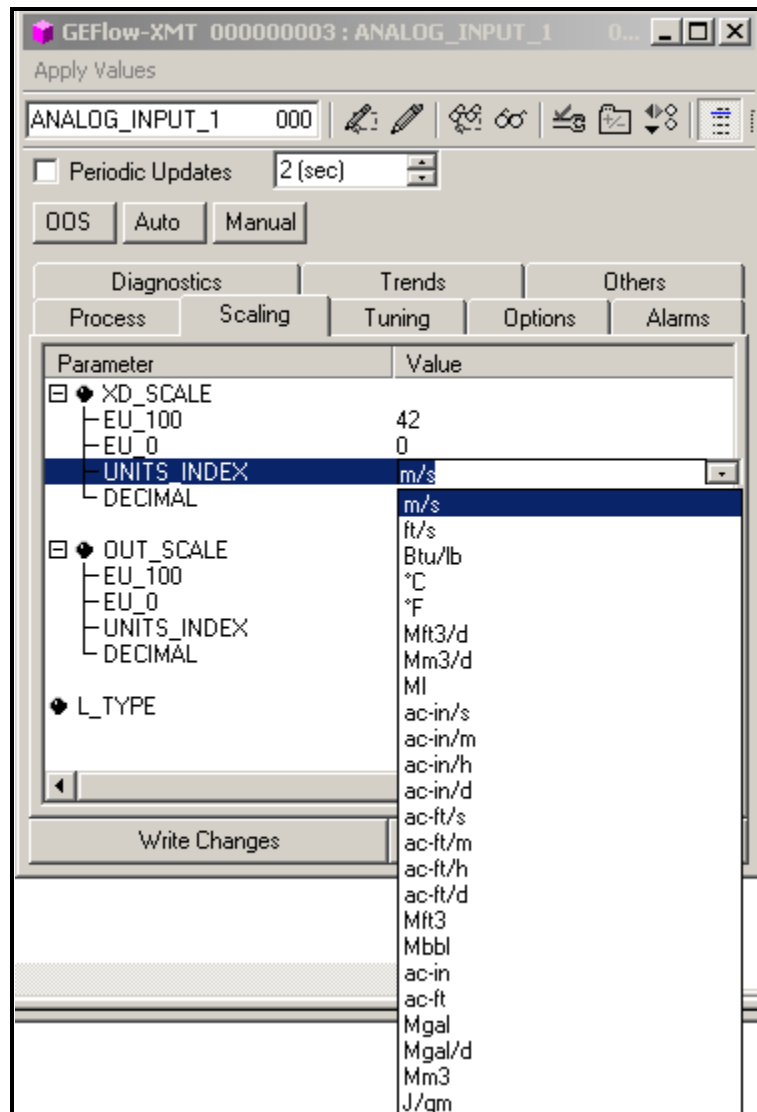

Figure D-3: Units Index Drop Down List

Resetting Instrument Totalizers

To reset the instrument totalizers:

1. Double click on the FLOW transducer block (in the tree under GEFlow-XMT; see Figure D-1 on page D-2).
2. Select the **Others** tab and scroll down to the CLEAR_TOTALIZERS listing.
3. Select **Clear** from the drop down list box (see Figure D-4 below).
4. After the totals have been reset, select **Normal** from the drop down list box to resume total accumulation.

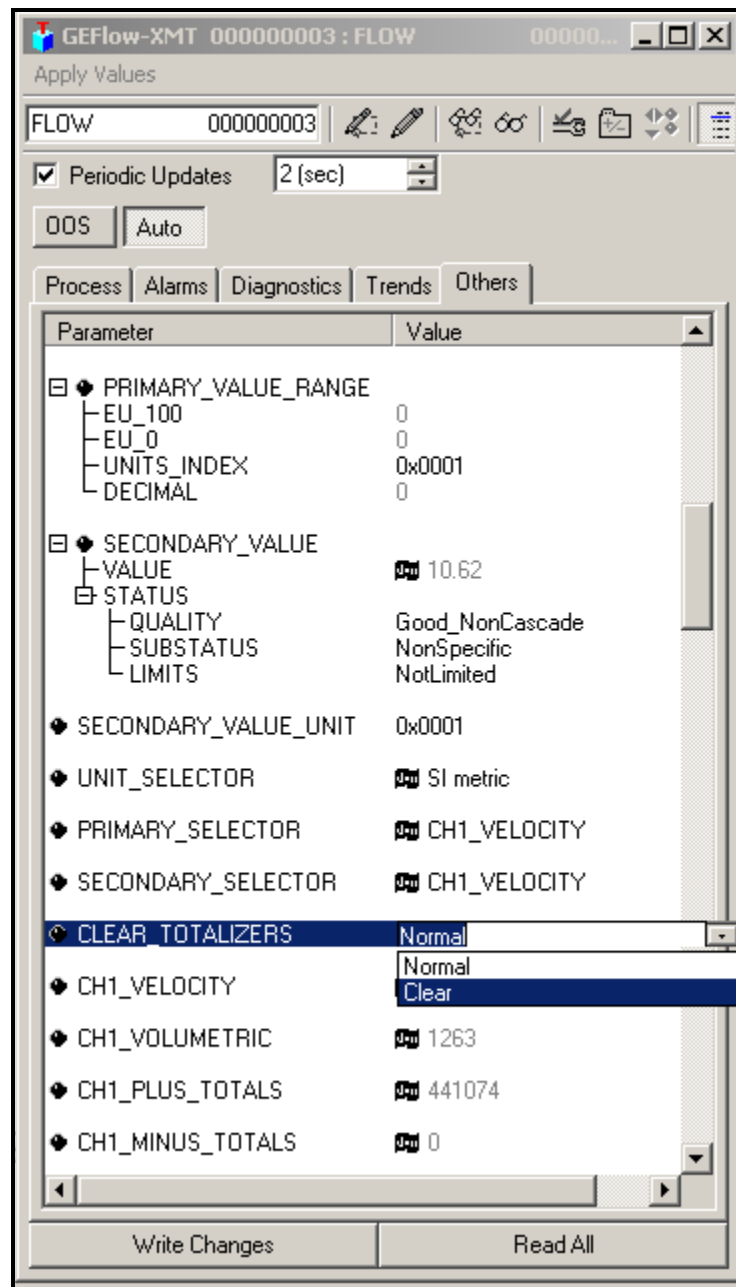

Figure D-4: Clear Totalizers Drop Down List

Function Block Application

Figure D-5 below is an example setup using the Function Block Application editor. The flowmeter AI blocks, along with the AO and PID of another device on the network, are displayed. We have connected the AI_1 OUT of the flowmeter to the CAS IN of the AO block. We have also connected the AI_2 OUT of the flowmeter to the CAS IN of the PID block.

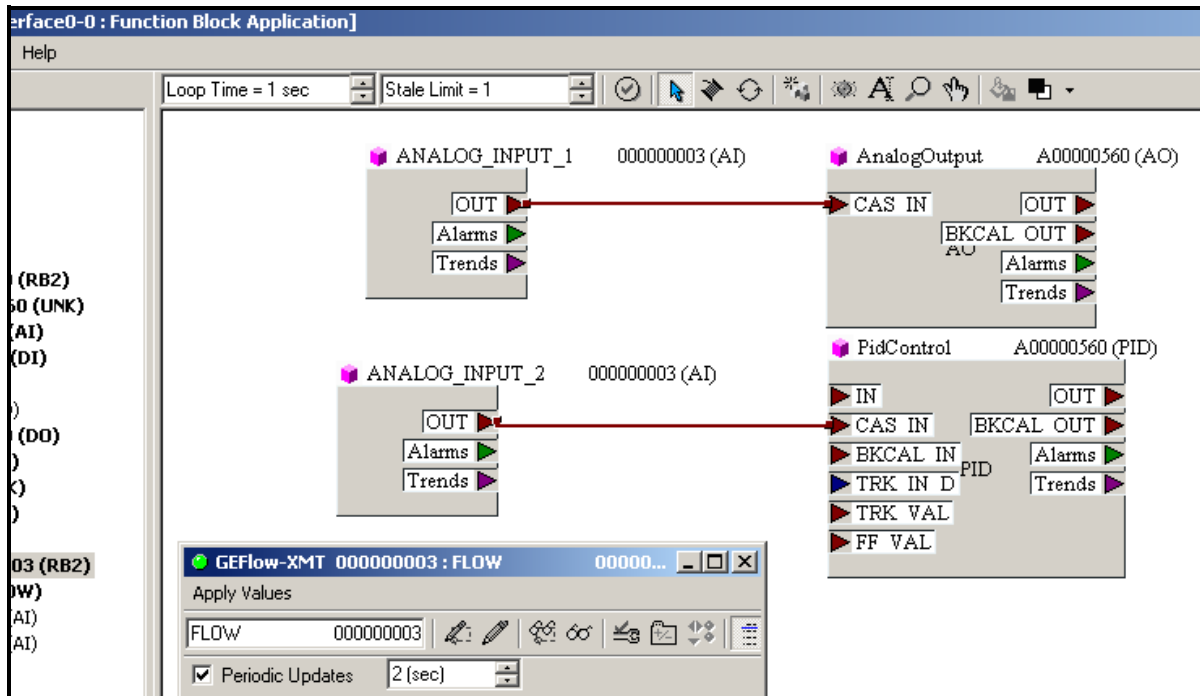

Figure D-5: Function Block Application

Index

- A**
- Abbreviations, Volumetric Units 1-10
 - ACTIV
 - Menu Map 1-9
 - Submenu 1-9
 - Activating Security 1-41
 - Alarms Card, Setting Up 1-17
 - Analog Inputs Card, Setting Up 1-19
 - Analog Outputs (Slot 0), Setting Up 1-16
 - AVRG Option 1-31, 1-33, 1-36
 - AVRG Submenu 1-29
- B**
- BACKL
 - Automatic Timeout 2-14
 - Submenu 2-1, 2-14
 - Backlight
 - See BACKL
 - Basic Programming
 - Minimum Requirements 1-8
 - Baud Rate
 - Available Options 1-34, 6-2
 - RS232 Port 6-2
 - Setting 1-34
 - BIG
 - Measurement Parameter Options 2-2
 - Screen Format 2-2
 - Submenu 2-1, 2-2
 - Burst Mode 1-9, 1-26
- C**
- Clear Site from Meter C-14
 - Clear Totalizers C-11
 - Clearing Data 5-1
 - CLOCK
 - Menu Map 1-32
 - Submenu 1-32
 - CLR Menu Map 5-1
 - COMM
 - Exiting 1-35
 - Menu Map 1-34
 - Submenu 1-34
 - Communications Port, Setting Up C-2, C-3
- D**
- DATA
 - Submenu 4-2
 - Data Record
 - Initial Setup B-2
 - Option Card B-1
 - User Program B-2
 - Date, Programming 1-32
 - DISP
 - Menu 2-1
 - Display
 - Metric or English 1-10
 - Displaying Data
 - BIG Format 2-2
 - Display Menu 2-1
 - DUAL Format 2-3
 - Graphical Format 2-4
 - Log File 2-7
 - Log File Display Options 2-8, 2-10
 - Log File, Graphical Format 2-9
 - Log File, Numeric Format 2-8
 - Numeric Key Functions 2-13
 - SLEEP Mode 2-15
 - Transducer Signals 2-11
 - Typical SIGNL Display Screen 2-12
 - DUAL
 - Screen Format 2-3
 - Submenu 2-1, 2-3
- E**
- Edit Functions Option C-16
 - Edit Menu C-2
 - ERROR
 - Response Options 1-15
 - Submenu 1-15, 3-1, 3-9
 - Ethernet
 - Setting Up 6-10
 - Setting up with PanaView C-3
- F**
- Foundation Fieldbus
 - Available Measurements D-1
 - Communications D-1
 - Function Keys, GRAPH Screen Format 2-5

Index (cont.)

<p style="text-align: center;">G</p> <p>GRAPH</p> <ul style="list-style-type: none"> Screen Display Options 2-6 Screen Format 2-4 Setting Up 2-4 Submenu 2-1, 2-4 Typical Display Screen 2-5 Using Function Keys 2-5 <p style="text-align: center;">H</p> <ul style="list-style-type: none"> Help, On-Line 1-6 Hyperterminal 6-4 <p style="text-align: center;">I</p> <p>I/O</p> <ul style="list-style-type: none"> Menu Map 1-15 Submenus 1-15 <p>IDM-Compatible Meters C-1</p> <p>INIT Submenu 1-29</p> <p>Initial Setup</p> <ul style="list-style-type: none"> Data Record B-2 <p>Instrument Data Manager (IDM) 1-34</p> <p style="text-align: center;">K</p> <p>Keypad</p> <ul style="list-style-type: none"> Description 1-2 Using 1-2 <p>Keys</p> <ul style="list-style-type: none"> Audio Alarm Volume 1-7 Console Control 1-7 Display Backlight 1-7 Display Contrast 1-7 Stopwatch Totalizer 1-7 Table of Functions 1-3 <p>Kinematic Viscosity 1-13, 1-30</p>	<p style="text-align: center;">L</p> <p>LOG</p> <ul style="list-style-type: none"> Entering the Submenu 2-7 Menu Map 2-7 Submenu 2-1, 2-7, 4-5, 5-4 <p>Log File</p> <ul style="list-style-type: none"> Header 3-1 Pages of Memory 3-1 Records 3-1 <p>Logging Data 3-1</p> <ul style="list-style-type: none"> Calculating Number of Pages 3-7 Calculating Number of Records 3-7 Circular 3-3 Measurement Parameter Options 3-2 Menu 3-1 Non-Circular 3-3 Time Increment 3-5 <p style="text-align: center;">M</p> <p>Measure Mode 1-9</p> <p>Measurements, Foundation Fieldbus D-1</p> <p>MEM Submenu 3-1, 3-7</p> <p>Menu Map</p> <ul style="list-style-type: none"> ACTIV Submenu 1-9 CLR 5-1 COMM Submenu 1-34 I/O Submenu 1-15 LOG Submenu 2-7 OPTN Submenu 1-16 PRNTR Submenu 4-9 SAVE Submenu 1-39 SECUR Submenu 1-41 SGNLS Submenu 4-10 STOP Submenu 4-8 <p>Menus, Edit C-2</p> <p>Meter Settings, Changing C-15</p> <p>MODBUS</p> <ul style="list-style-type: none"> Register Map for 1-37 <p>MODBUS/TCP</p> <ul style="list-style-type: none"> Setting Up 6-11 <p style="text-align: center;">N</p> <p>Network ID Number 1-34</p> <p>Numeric Keys, Displaying SIGNAL Data ... 2-13</p>
--	--

Index (cont.)

O	P
On-Line Help	1-6
Option Card	
Alarms	1-17
Analog Inputs	1-19
Data Record	B-1
RTD Inputs	1-20
Totalizer/Frequency	1-18
OPTN	
Menu Map	1-16
Submenu	1-16
	PanaView
	1-34
	PanaView, Applications of
	C-1
	Password
	Default
	1-41
	Entering
	1-41
	PIPE
	Submenu
	1-12
	Pipe OD, Programming
	1-12
	Pipe Wall, Programming
	1-13
	Plotting Signal
	C-11
	Printer
	Acceptable Models
	4-9
	Interface
	4-9
	Setting Up
	4-9
	Printing Data
	Live Data, Graphical Format
	4-3
	Logged Data, Graphical Format
	4-6
	Logged Data, Numeric Format
	4-5
	Measurement Parameter Options
	4-2
	Sample Printout, Live Graphical
	4-4
	Sample Printout, Live Numeric
	4-3
	Sample Printout, Logged Graphical
	4-6
	Sample Printout, Logged Numeric
	4-5
	Sample Printout, Signal Array
	4-10
	Sample Printout, Site Data
	4-7
	Serial Port
	4-1
	Site File
	4-7
	PRNT
	Menu
	4-1
	PRNTR
	Menu Map
	4-9
	Submenu
	4-9
	PROG
	Key
	1-8
	Menu Map
	4-7
	Submenu
	4-7
	Properties Option in Edit Menu
	C-7

Index (cont.)

R	
Recalling a Site	1-40
RECLL	
Entering	1-40
Submenu	1-40
RECLL Submenu	1-40
Reynolds Correction	1-13
RS232, RS485	
See Serial Interface	
RTD Inputs Card, Setting Up	1-20
S	
SAVE	
Entering	1-39
Menu Map	1-39
Submenu	1-39
Save Site Print to PC	C-14
Save Site to Meter	C-12
Save Site to PC	C-13
SECUR	
Entering	1-41
Menu Map	1-41
Submenus	1-41
SECUR Submenu	1-41
Serial Communications	1-34
Baud Rate	1-34
Network ID Number	1-34
UART Bit Options	1-34
Serial Interface	
Configuring RS485 Converter	6-7
GE Panametrics Cables	6-1
Optional RS485	6-5
RS232 Terminal Block Pins	6-1
RS485 Interface Converter	6-5
RS485 Multi-Point Wiring	6-7
RS485 Point-To-Point Wiring	6-6
Setting Up Windows 3.X	6-2
Setting Up Windows 9X/NT	6-4
Standard RS232	6-1
Uploading Logs in Windows 3.X	6-3
Uploading Logs in Windows 9X/NT	6-4
Wiring RS232	6-1
SETUP	
Entering	1-23
Submenus	1-23
SGNLS	
Menu Map	4-10
Submenu	4-10
Signal	
Graph	C-11
Plot	C-11
Reading	C-10
Save	C-11
Type	C-10
Signal Array Data, Printing	4-10
SIGNL	
Submenu	2-1, 2-11
Typical Display Screen	2-12
SIGNL Option	1-23
Site Edit Menu	C-16
Site File	
Saving	1-39
Site File Operations	C-12
Site Files, Handling	C-12
Site Label	1-10
Site Message	1-10
SITE Submenu	5-3
Site, Recalling a	1-40
Skan Mode	1-9
SLEEP Submenu	2-1, 2-15
Slot 0	
Analog Outputs	1-16
Setting Up	1-16
Slot Number	1-15
STD Submenu	3-1, 3-2
STOP	
Menu Map	4-8
Submenu	3-1, 3-8, 4-8
System Security	1-41
SYSTEM	
Submenu	1-10

Index (cont.)

T

T,P

Entering Values 1-21

Submenu 1-21

Terminal Software

Hyperterminal 6-4

Setting Up Windows 3.X 6-2

Setting Up Windows 9X/NT 6-4

TOTAL Submenu 5-2

Totalizer/Frequency Card

Setting Up 1-18

Transducer

Special 1-12

Transducer Signals

Display Options 2-11

Displaying 2-11

U

Uploading Logs

Windows 3.X 6-3

Windows 9X/NT 6-4

User Program

Data Record B-2

Entering 1-8

Submenus 1-1

V

Volumetric Units

Abbreviations 1-10

Selecting 1-10

Table of Options 1-10

Z

ZERO

Entering Cutoff Value 1-20

Submenu 1-20

We,

Panametrics Limited
Shannon Industrial Estate
Shannon, County Clare
Ireland

declare under our sole responsibility that the

DF868 Liquid Ultrasonic Flowmeter
GF868 Flare Gas Ultrasonic Flowmeter
GM868 Multi-Purpose Gas Ultrasonic Flowmeter
GN868 Natural Gas Ultrasonic Flowmeter
GS868 Steam Mass Ultrasonic Flowmeter

to which this declaration relates, are in conformity with the following standards:

- EN 61326:1998, Class A, Annex A, Continuous Unmonitored Operation
- EN 61010-1:1993 + A2:1995, Overvoltage Category II, Pollution Degree 2

following the provisions of the 89/336/EEC EMC Directive and the 73/23/EEC Low Voltage Directive.

The units listed above and any transducers supplied with them (spoolpieces are addressed under a separate declaration of conformity) do not bear CE marking for the Pressure Equipment Directive, as they are supplied in accordance with Article 3, Section 3 (sound engineering practices and codes of good workmanship) of the Pressure Equipment Directive 97/23/EC for DN<25.

Shannon - June 1, 2002

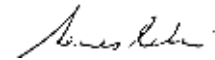

Mr. James Gibson
GENERAL MANAGER



CERT-DOC-H4



August 2004

Nous,

Panametrics Limited
Shannon Industrial Estate
Shannon, County Clare
Ireland

déclarons sous notre propre responsabilité que les

DF868 Liquid Ultrasonic Flowmeter
GF868 Flare Gas Ultrasonic Flowmeter
GM868 Multi-Purpose Gas Ultrasonic Flowmeter
GN868 Natural Gas Ultrasonic Flowmeter
GS868 Steam Mass Ultrasonic Flowmeter

relatif à cette déclaration, sont en conformité avec les documents suivants:

- EN 61326:1998, Class A, Annex A, Continuous Unmonitored Operation
- EN 61010-1:1993 + A2:1995, Overvoltage Category II, Pollution Degree 2

suivant les règles de la Directive de Compatibilité Electromagnétique 89/336/EEC et de la Directive Basse Tension 73/23/EEC.

Les matériels listés ci-dessus ainsi que les transducteurs pouvant être livrés avec (les manchettes faisant l'objet d'une déclaration de conformité séparée) ne portent pas le marquage CE de la directive des équipements sous pression, car ils sont fournis en accord avec la directive 97/23/EC des équipements sous pression pour les DN<25, Article 3, section 3 qui concerne les pratiques et les codes de bonne fabrication pour l'ingénierie du son.

Shannon - June 1, 2002

Mr. James Gibson
DIRECTEUR GÉNÉRAL



CERT-DOC-H4



August 2004

Wir,

**Panametrics Limited
Shannon Industrial Estate
Shannon, County Clare
Ireland**

erklären, in alleiniger Verantwortung, daß die Produkte

**DF868 Liquid Ultrasonic Flowmeter
GF868 Flare Gas Ultrasonic Flowmeter
GM868 Multi-Purpose Gas Ultrasonic Flowmeter
GN868 Natural Gas Ultrasonic Flowmeter
GS868 Steam Mass Ultrasonic Flowmeter**

folgende Normen erfüllen:

- EN 61326:1998, Class A, Annex A, Continuous Unmonitored Operation
- EN 61010-1:1993 + A2:1995, Overvoltage Category II, Pollution Degree 2

gemäß den Europäischen Richtlinien, Niederspannungsrichtlinie Nr.: 73/23/EG und EMV-Richtlinie Nr.: 89/336/EG.

Die oben aufgeführten Geräte und zugehörige, mitgelieferte Schallwandler (Messrohre werden in einer separaten Konformitätserklärung behandelt) tragen keine CE-Kennzeichnung gemäß der Druckgeräte-Richtlinie, da sie in Übereinstimmung mit Artikel 3, Absatz 3 (gute Ingenieurpraxis) der Druckgeräte-Richtlinie 97/23/EG für DN<25 geliefert werden.

Shannon - June 1, 2002

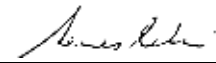

Mr. James Gibson
GENERALDIREKTOR



CERT-DOC-H4



August 2004



USA

1100 Technology Park Drive
Billerica, MA 01821-4111
Web: www.gesensing.com

Ireland

Sensing House
Shannon Free Zone East
Shannon, Co. Clare
Ireland

