

Ultrasonic Controllers

SITRANS LUT400 (HART)

Operating Instructions · 08/2012



SITRANS

SIEMENS

Safety Guidelines: Warning notices must be observed to ensure personal safety as well as that of others, and to protect the product and the connected equipment. These warning notices are accompanied by a clarification of the level of caution to be observed.

Qualified Personnel: This device/system may only be set up and operated in conjunction with this manual. Qualified personnel are only authorized to install and operate this equipment in accordance with established safety practices and standards.

Unit Repair and Excluded Liability:

- The user is responsible for all changes and repairs made to the device by the user or the user's agent.
- All new components are to be provided by Siemens Milltronics Process Instruments.
- Restrict repair to faulty components only.
- Do not reuse faulty components.

Warning: Cardboard shipping package provides limited humidity and moisture protection. This product can only function properly and safely if it is correctly transported, stored, installed, set up, operated, and maintained.

This product is intended for use in industrial areas. Operation of this equipment in a residential area may cause interference to several frequency based communications.

Note: Always use product in accordance with specifications.

Copyright Siemens AG 2012. All Rights Reserved

Disclaimer of Liability

This document is available in bound version and in electronic version. We encourage users to purchase authorized bound manuals, or to view electronic versions as designed and authored by Siemens Milltronics Process Instruments. Siemens Milltronics Process Instruments will not be responsible for the contents of partial or whole reproductions of either bound or electronic versions.

While we have verified the contents of this manual for agreement with the instrumentation described, variations remain possible. Thus we cannot guarantee full agreement. The contents of this manual are regularly reviewed and corrections are included in subsequent editions. We welcome all suggestions for improvement.

Technical data subject to change.

MILLTRONICS® is a registered trademark of Siemens Milltronics Process Instruments.

Contact SMPI Technical Publications

at the following address:

Technical Publications
Siemens AG
Siemens Milltronics Process Instruments
1954 Technology Drive, P.O. Box 4225
Peterborough, Ontario, Canada, K9J 7B1
Email: techpubs.smpi@siemens.com

European Authorized Representative

Siemens AG
Industry Sector
76181 Karlsruhe
Deutschland

- For a selection of Siemens Milltronics level measurement manuals, go to: **www.siemens.com/processautomation**. Under Process Instrumentation, select *Level Measurement* and then go to the manual archive listed under the product family.
- For a selection of Siemens Milltronics weighing manuals, go to: **www.siemens.com/processautomation**. Under Weighing Technology, select *Continuous Weighing Systems* and then go to the manual archive listed under the product family.

Table of Contents

Table of Contents	i
Introduction	1
The Manual	1
Manual symbols	1
Application examples	1
Change History	2
Sensor node	2
LUI	2
Safety Notes	3
Safety marking symbols	3
FCC Conformity	4
CE Electromagnetic Compatibility (EMC) Conformity	4
Description	7
Overview	7
Features	7
Models	8
Applications	8
Approvals and Certificates	8
Installing and Mounting	9
Mounting locations	9
Mounting instructions	10
Wall or panel mount	10
Remote mounted lid.....	12
Pipe mount	13
DIN-rail mount	15
Preparation for cable entry	16
Cable routed through conduit.....	16
Cable exposed and entering through the cable glands.....	17
SITRANS LUT400 wiring compartment	17
The Battery	17
Connecting	19
Safety notes for connection	19
Connecting SITRANS LUT400	20
Wiring compartment	20
Power	21
Cables	22
Transducers	23
Temperature sensor	23
Relays	24
Communications	24
Connecting via USB.....	25
Connecting HART	26
Level system synchronization	27
Discrete inputs	28

Remote mounted lid with extension cable	29
Extension cable	30
Connecting in hazardous area installations	31
Commissioning	33
Local Commissioning	33
Activating SITRANS LUT400	33
The LCD Display	34
Measurement mode display: Normal operation	
PROGRAM mode display.....	35
Key functions in Measurement mode.....	35
Programming SITRANS LUT400	35
Quick Start Wizards	38
Quick Start Wizards via LUI	38
Requesting an Echo Profile	57
Device Address	57
Testing the configuration	57
Application examples	58
Level Application Example	58
Flow application example	59
General Operation	63
Starting measurement	63
Measurement conditions	63
Response Rate	63
Dimensions	63
Fail-safe	63
Relays	64
General introduction	64
Relay function	65
Alarm.....	65
Pump.....	65
Miscellaneous.....	66
Relay behaviour under fail-safe conditions	66
Relay states	67
Relay related parameters.....	67
Relays controlled by HART Communications	69
Discrete Inputs	69
Backup Level Override	69
Basic operation.....	69
Backup Level Override parameters	69
Level Override conditions.....	70
Affect of Backup Level Override.....	70
Additional considerations	70
Pump Interlocks	70
Switch (DI) Alarm	70
Discrete Input Logic	71
mA Control	72
mA output	72
Verifying the mA range	72
Volume	73
Readings	73

Vessel Shape and Dimensions	73
Characterization chart	73
Alarms	76
Level	76
In-bounds/ Out-of-bounds Range	77
Temperature	78
Switch (Discrete Input) Alarm	78
Fail-safe Fault Alarm	79
Flowrate	79
Pump Control	79
Pump Control options	80
Pump Control algorithms.....	80
Setting a pump down (wet well) group	80
Other Pump Control algorithms	82
Setting a pump up (reservoir) group	85
Pump Control Interlocks	87
Other Pump Controls	87
Totalizing pumped volume	88
Setting a pump to run-on.....	88
Setting the pump start delays	89
Reducing wall cling.....	90
Saving energy	91
Tracking pump usage.....	92
Other controls	92
Relays controlled by time	92
Flow	93
Flow calculation	93
Totalizing flow	93
External Totalizers and Flow Samplers	93
Relay contacts	94
Totalizer	95
Flow Sampler	96
Open Channel Monitoring (OCM)	97
Method of Flow Calculation	98
Common parameters	98
Setting Zero Head	99
PMDs with Exponential Flow to Head function	100
Applicable weir profiles.....	100
Parshall Flume.....	101
Leopold Lagco Flume.....	102
Cut Throat Flume	103
Khafagi Venturi	104
Universal calculation support	116
Typical flow characterization.....	116
Example flumes.....	117
Example weirs.....	118
Trends	118
Data logging	119
Viewing the Data Log	119
Simulation	120
Pump relay behaviour during simulation.....	121

Fail-safe and Simulation	122
HART status	122
Simulation process	122
Application test	123
SITRANS LUT400 Communication Systems	124
LUT400 Communications (HART)	124
HART Version	124
Burst mode.....	125
HART multi-drop mode.....	125
SIMATIC PDM.....	125
HART Electronic Device Description (EDD)	125
HART Status	125
LUT400 Communication connections	125
Configuring communication ports	126
HART modem.....	126
USB cable.....	126
Communication troubleshooting	126
Remote operation	127
Operation via SIMATIC PDM 6 (HART)	127
Features and Functions	127
Startup and Configuration	127
SIMATIC PDM version.....	128
Electronic Device Description (EDD)	128
Operation via Web Browser (USB)	129
Features and Functions	129
Startup and Configuration	129
Operation via AMS Device Manager (HART)	131
Features and Functions	131
Startup and Configuration	131
Electronic Device Description (EDD).....	131
Operation via Field Communicator 375/475 (FC375/FC475) (HART)	133
Features and Functions	133
Startup and Configuration	133
Operation via FDT (Field Device Tool)	135
Features and Functions	135
Startup and Configuration	135
Device Type Manager (DTM).....	135
SITRANS DTM version 3.1	135
Electronic Device Description (EDD).....	135
Parameter reference (LUI)	137
Wizards	137
Setup	138
Maintenance and Diagnostics	198
Communication	215
Security	216
Language	217
Alphabetical parameter list	218
Service and Maintenance	225
Firmware updates	225

Transferring parameters using LUT400 display lid	225
Replacing the Battery	226
Decontamination Declaration	227
Diagnosing and Troubleshooting	229
Communication Troubleshooting	229
Device Status Icons	230
General Fault Codes	231
Common Problems Chart	234
Noise Problems	240
Determine the Noise Source	240
Non-Transducer Noise Sources	241
Common Wiring Problems	241
Reducing Electrical Noise	241
Reducing Acoustical Noise	242
Measurement Difficulties	242
Loss of Echo (LOE)	242
Adjust Transducer Aiming.....	242
Increase Fail-safe Timer Value.....	243
Install a Transducer with a Narrower Beam.....	243
Fixed Reading	243
Obstructions in the Sound Beam	243
Nozzle Mountings	243
Set the SITRANS LUT400 to Ignore the Bad Echo	244
Wrong Reading	244
Types of Wrong Readings	244
Liquid Splashing	244
Adjust the Echo Algorithm	244
Transducer Ringing	245
Echo Profile Display	245
Trend Display	245
Technical Data	247
Power	247
Performance	247
Interface	248
Mechanical	250
Environmental	250
Approvals	251
Dimension Drawings	253
Appendix A - Technical Reference	255
Principles of Operation	255
Process Variables	255
Transmit Pulse	255
Echo Processing	255
Echo Selection	256
Time Varying Threshold (TVT).....	256
Algorithm.....	257
Confidence.....	257
Echo Threshold.....	257
Figure of Merit.....	258

Shaper Mode and Auto False Echo Suppression	258
Measurement Range	259
Measurement Response	260
Damping.....	260
Analog Output	261
Current Output Function (2.6.1.)	261
Loss of Echo (LOE)	261
Fail-safe Mode	261
Distance Calculation	262
Sound Velocity	262
Volume Calculation	263
Pump Totalizers	264
Inflow/Discharge Adjust	264
Flow Calculation	265
Method of Flow Calculation	266
Data Logging	267
Appendix B - Certificates and Support	269
Certificates	269
Technical Support	269
Service & Support on the Internet	269
Additional Support	269
List of Abbreviations	271
LCD Menu Structure	273
Glossary	279
Index	281

Introduction

The Manual

Notes:







- This product is intended for use in industrial areas. Operation of this equipment in a residential area may cause interference to several frequency based communications.
- Please follow the installation and operating procedures for a quick, trouble-free installation and to ensure the maximum accuracy and reliability of your SITRANS LUT400.
- This manual applies to the SITRANS LUT400 series only.

This manual will help you set up your SITRANS LUT400 for optimum performance. We always welcome suggestions and comments about manual content, design, and accessibility. Please direct your comments to techpubs.smpi@siemens.com.

For other Siemens level measurement manuals, go to: www.siemens.com/level, and look under **Level Measurement**.

Manual symbols

Please note their use carefully.

	Alternating Current
	Direct Current
	Earth (ground) Terminal
	Protective Conductor Terminal
	Caution (refer to instructions)
	No co-axial cable connections

Application examples

The application examples used in this manual illustrate typical installations using SITRANS LUT400. As there is often a range of ways to approach an application, other configurations may also apply.

In all examples, substitute your own application details. If the examples do not apply to your application, check the applicable parameter reference for the available options.

Change History

Sensor node

Firmware Rev.	PDM EDD Rev.	Date	Changes
1.00.00	1.00.00	August 3, 2012	<ul style="list-style-type: none">Initial release.

LUI

Firmware Rev.	Date	Changes
1.00.00	August 3, 2012	<ul style="list-style-type: none">Initial release.

Safety Notes

Special attention must be paid to warnings and notes highlighted from the rest of the text by grey boxes.



WARNING: relates to a caution symbol on the product, and means that failure to observe the necessary precautions can result in death, serious injury, and/or considerable material damage.



WARNING¹: means that failure to observe the necessary precautions can result in death, serious injury, and/or considerable material damage.

Note: means important information about the product or that part of the operating manual.

Safety marking symbols

In manual	On product	Description
		Earth (ground) Terminal (shield)
		Protective Conductor Terminal
		Dispose of in an environmentally safe manner, and according to local regulations.
		WARNING: refer to accompanying documents (manual) for details.
		CAUTION: Observe electrostatic discharge precautions prior to handling electronic components within the wiring compartment.

¹ This symbol is used when there is no corresponding caution symbol on the product.

FCC Conformity

US Installations only: Federal Communications Commission (FCC) rules

! WARNING: Changes or modifications not expressly approved by Siemens could void the user's authority to operate the equipment.

Notes:

- This equipment has been tested and found to comply with the limits for a Class A digital device, pursuant to Part 15 of the FCC Rules. These limits are designed to provide reasonable protection against harmful interference when the equipment is operated in a commercial environment.
- This equipment generates, uses, and can radiate radio frequency energy and, if not installed and used in accordance with the instruction manual, may cause harmful interference to radio communications. Operation of this equipment in a residential area is likely to cause harmful interference to radio communications, in which case the user will be required to correct the interference at his own expense.

CE Electromagnetic Compatibility (EMC) Conformity

This equipment has been tested and found to comply with the following EMC Standards:

EMC Standard	Title
CISPR 11:2004/EN 55011: 2009, CLASS A	Limits and methods of measurements of radio disturbance characteristics of industrial, scientific, and medical (ISM) radio-frequency equipment.
EN 61326-1: 2006 IEC 61326-1: 2005	Electrical Equipment for Measurement, Control and Laboratory Use – Electromagnetic Compatibility.
EN61000-3-2: 2006	Electromagnetic Compatibility (EMC) Part 3-2: Limits for harmonic current emissions (equipment input current $\leq 16A$ per phase).
EN61000-3-3: 2008 A1: 2001 + A2: 2005	Electromagnetic Compatibility (EMC) Part 3-3: Limitation of voltage changes, voltage fluctuations, and flicker in public low voltage supply systems, for equipment with rated current $\leq 16A$ per phase and not subject to conditional connection.
EN61000-4-2:2009	Electromagnetic Compatibility (EMC) Part 4-2: Testing and measurement techniques – Electrostatic discharge immunity test.
EN61000-4-3:2006	Electromagnetic Compatibility (EMC) Part 4-3: Testing and measurement techniques – Radiated, radio-frequency, electromagnetic field immunity test.
EN61000-4-4:2004	Electromagnetic Compatibility (EMC) Part 4-4: Testing and measurement techniques – Electrical fast transient/burst immunity test.
EN61000-4-5:2006	Electromagnetic Compatibility (EMC) Part 4-5: Testing and measurement techniques – Surge immunity test.

EMC Standard	Title
EN61000-4-6:2009	Electromagnetic Compatibility (EMC) Part 4-6: Testing and measurement techniques – Immunity to conducted disturbances, induced by radio-frequency fields.
EN61000-4-8:2010	Electromagnetic Compatibility (EMC) Part 4-8: Testing and measurement techniques – Power frequency magnetic field immunity test.
EN61000-4-11: 2004	Electromagnetic Compatibility (EMC) Part 4-11: Testing and measurement techniques - voltage clips, short interruptions and voltage variations immunity tests.

Notes

Description

Overview

The Siemens SITRANS LUT400 series controllers are compact, single point, long-range ultrasonic controllers for continuous level measurement of liquids, slurries, and solids, and high accuracy monitoring of open channel flow.

The series is compatible with Siemens full line of EchoMax[®] Transducers, allowing an operating range of 0.3 to 60 meters (dependent on transducer). The SITRANS LUT400 has been coupled with a backlit Local User Interface (LUI) display featuring menu driven programming and a host of wizards for plug and play performance. The LUT400 also features our next generation of Sonic Intelligence[®], further strengthening our industry leading measurement performance while improving ease of use. With a number of advanced pump, alarm, and flow control features, plus a real time clock and an integrated datalogger, the LUT400 is a powerful and comprehensive solution for your Ultrasonic applications.

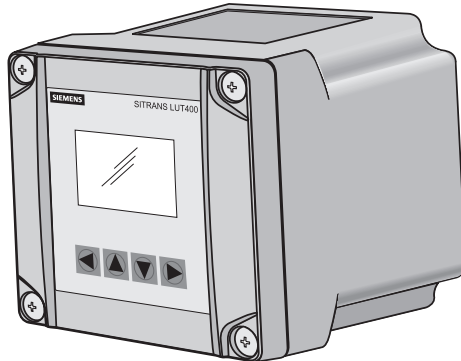

Features

- Small 1/2 DIN enclosure footprint with standard universal mounting bracket for wall, pipe, and DIN rail, plus an optional panel mount
- Easy to use LUI display with local four-button programming, menu-driven parameters, and Wizard support for key applications
- Level, Volume, High Accuracy OCM Flow monitoring
- Three relays combined with a suite of pump, alarm, and relay control features
- HART Communications
- EDDs for SIMATIC PDM, AMS Device Manager, and Field Communicator 375/475, plus DTMs for FDTs (Field Device Tools)
- Integrated web browser for local programming from an intuitive web-based interface
- Two discrete inputs for backup level override and pump interlock functions
- Echo profile and trend views from the local display
- Patented digital receiver for improved performance in electrically noisy applications (close proximity to VSDs)
- Real time clock with daylight savings time supporting an integrated datalogger and energy saving algorithms for minimizing pump operation during high cost energy periods
- Removable terminal blocks for ease of wiring

Models

The SITRANS LUT400 comes in three different models, depending on the application, level of performance and functionality required:

- SITRANS LUT420 Level Controller - Level or volume measurement, basic pump control functions, and basic data logging capability
- SITRANS LUT430 Pump and Flow Controller - Full suite of advanced control functionality, open channel flow monitoring, and basic data logging capability
- SITRANS LUT440 High Accuracy OCM - Best performance (rated at 1 mm accuracy up to 3 meters), full suite of advanced control functionality, and enhanced data logging capability

Applications

- Liquids, solids and slurry monitoring in small to large process and storage vessels or outdoor applications (open air)
- Environmental, Mining/Aggregates/Cement, Food & Beverage, and Chemical market applications primarily
- Key sample applications include: wet wells, reservoirs, flumes/weirs, chemical storage, liquid storage, hoppers, crusher bins, dry solids storage

Approvals and Certificates

The SITRANS LUT400 is available with General Purpose and Hazardous Area approvals. It also has a number of approvals for specialized applications. For details, see chart below.

Note: The device nameplate lists the approvals that apply to your device.

Application Type		Approval Rating	Valid for:
Non-hazardous	General Purpose	CSA _{US/C} , CE, FM, UL listed, C-TICK	N. America, Europe, Australia
Hazardous	Non-incendive	CSA Class I, Div. 2, Groups A, B, C, D; Class II, Div 2, Groups F, G; Class III ^a	Canada

^a. Not available for devices with remote display.

Installing and Mounting

Installing

Notes:

- Installation must only be performed by qualified personnel, and in accordance with local governing regulations.
- This product is susceptible to electrostatic shock. Follow proper grounding procedures.



All field wiring must have insulation suitable for at least 250V.



Hazardous voltages present on transducer terminals during operation.



DC input terminals shall be supplied from a source providing electrical isolation between the input and output, in order to meet applicable safety requirements of IEC 61010-1.

- Relay contact terminals are for use with equipment that has no accessible live parts and wiring that has insulation suitable for at least 250 V. The maximum allowable working voltage between adjacent relay contacts shall be 250 V.
- The non-metallic enclosure does not provide grounding between conduit connections. Use grounding type bushings and jumpers.

Mounting locations

Recommended

- Ambient temperature is always within -20 to +50 °C (-4 to +122 °F)
- SITRANS LUT400 display window is at shoulder level, unless most interaction is through a SCADA system
- Easy access to local push buttons is provided
- Cable length requirements are minimized
- Mounting surface is free from vibration
- Sufficient room to swing device lid open and have clear access.
- A place for a laptop computer is provided for on-site configuration (optional, as laptop not required for configuration).

Avoid

- Exposure to direct sunlight. (Provide a sun shield to avoid direct sunlight.)
- Proximity to high voltage/current runs, contactors, SCR or variable frequency motor speed controllers

Mounting instructions

Mounting instructions differ for wall, pipe, DIN-rail, and remote display panel mount devices. Please follow the specific instructions for your device.

Note: When routing cable through a conduit, please follow the Cable Routing instructions on page 16 before mounting the SITRANS LUT400.

Wall or panel mount

All configurations of the SITRANS LUT400 are shipped with a mounting back plate. SITRANS LUT400 has the option of a lid with a Local User Interface (LUI) display, a remote display for panel mount configuration, or a blank lid. The panel mount model comes with both a LUI display and a blank lid.

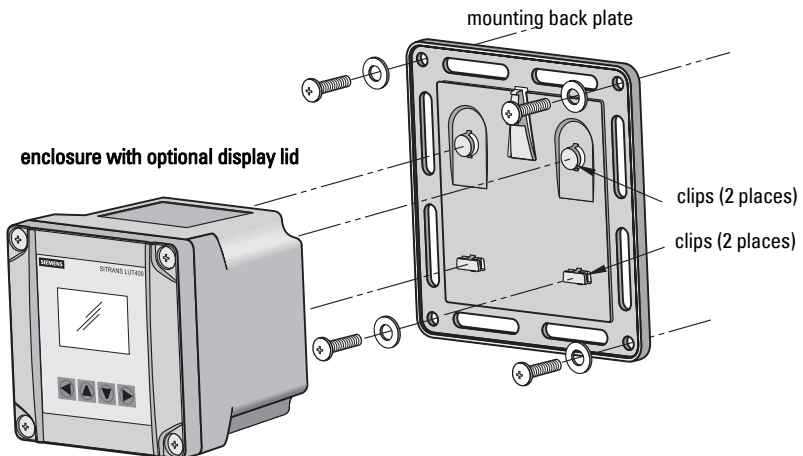

Note: Wall mount fasteners not included.

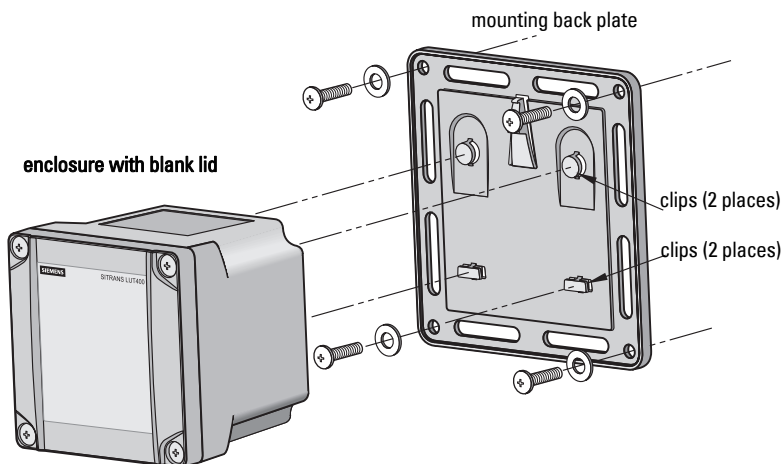

Note: Wall mount fasteners not included.

back of enclosure

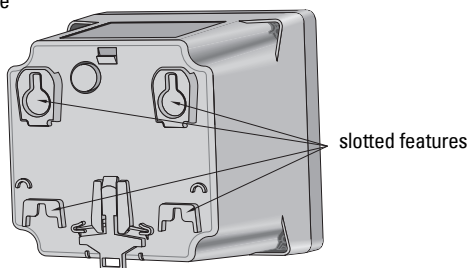

For a more detailed dimension drawing, see *SITRANS LUT400 Dimensions* on page 253.

Wall mounting of the enclosure

1. Mark and drill four holes in the mounting surface for the four screws (customer supplied).
2. Fasten with a screwdriver.
3. Line up slotted features on back of device with clips on mounting back plate. Press the LUT400 flush against the back plate and slide downward to fasten in place.

mounting screw holes on back plate

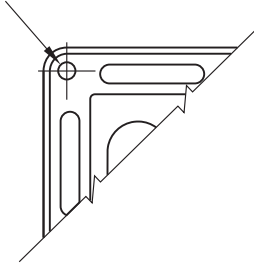

Please note:

- Recommended fastener size: M8 or 5/16 " screw with washer of maximum 17 mm or 5/8 " outside diameter
- Recommended mounting: mount directly to wall. If alternate mounting surface is used, it **MUST** be able to support four times the weight of the device.

Remote mounted lid

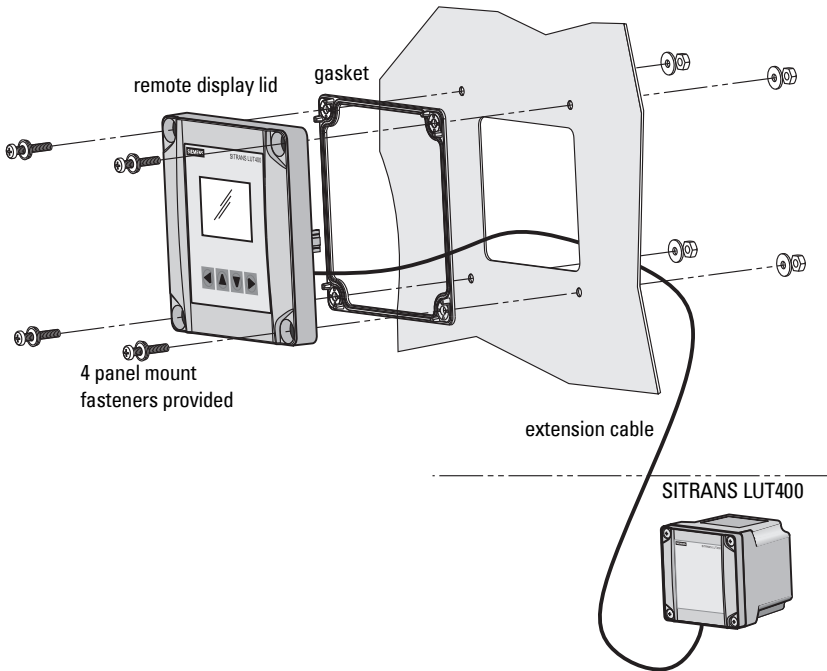

For a more detailed dimension drawing, see *SITRANS LUT400 Dimensions* on page 253 and *Cutout Dimensions (for Remote Panel Mount)* on page 254.

Mounting the remote lid

Note: Remote mounted lid can be mounted up to 5 m from the device using two optional cable extensions (each 2.5 m in length). For instructions on how to connect an extension cable, see *Remote mounted lid with extension cable* on page 29.

1. Using the template provided, cut out the necessary hole for the remote LUI display lid. Place the gasket inside the lid, aligning the mounting holes. Align the back of the remote display lid with the panel hole cut-out. Mark and drill four holes in the mounting surface for the four screws (provided).
2. Fasten with a screwdriver and wrench.

Note: Recommended torque on fastening screws for good seal:

- 1.1 N m
- 10 in-lbs

Please note:

- Recommended mounting: mount to panel, up to 5 m from the device. If alternate mounting surface is used, it **MUST** be able to support four times the weight of the device.

Note: Fasteners included: M5 screw, seal washer, M5 flat washer and nut. These fasteners are required to maintain IP65 rating on remote lid.

Pipe mount

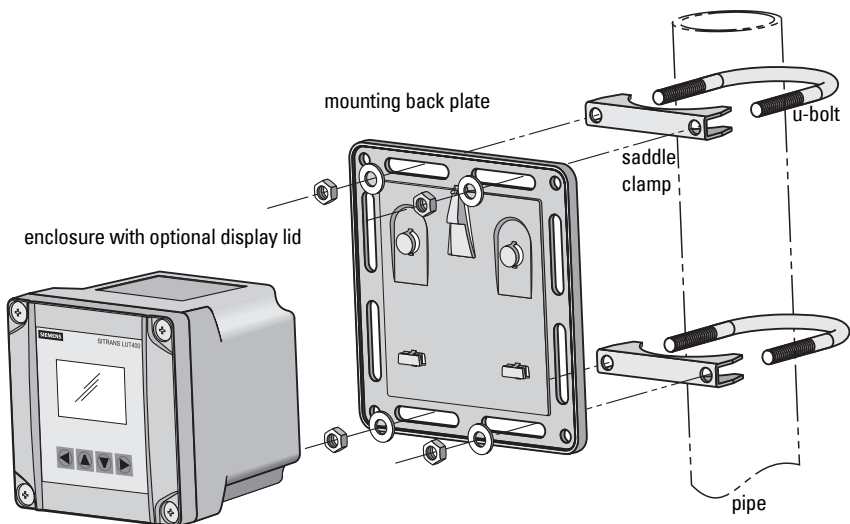

Note: Pipe mount fasteners not included.

For a more detailed dimension drawing, see *SITRANS LUT400 Dimensions* on page 253.

Mounting the enclosure

1. Fasten the mounting back plate to the pipe using u-bolts, saddle clamps, (customer supplied) suitable to pipe diameter.
2. Fasten bolts with a wrench. Do not over-tighten so that plate becomes twisted or bent. This may hinder ability to clip the LUT400 to the back plate.
3. Fasten device to mounting back plate (as described in step 3 of *Wall mounting of the enclosure* on page 11).

Please note:

- Recommended mounting: directly to horizontal or vertical pipe. If alternate mounting surface is used, it **MUST** be able to support four times the weight of the device.
- Recommended pipe dimensions: maximum: 3" pipe, minimum: 3/4" pipe
- Recommended fastener sizes:
 - U-Bolts:
 - maximum: 3" pipe size with M8 or 3/8" thread
 - minimum: 3/4" pipe size with M6 or 1/4" thread
 - Hex Nuts:
 - M6 or 1/4" to M8 or 3/8"
 - Washer:
 - maximum: 16 mm or 13/16" outside diameter.

DIN-rail mount

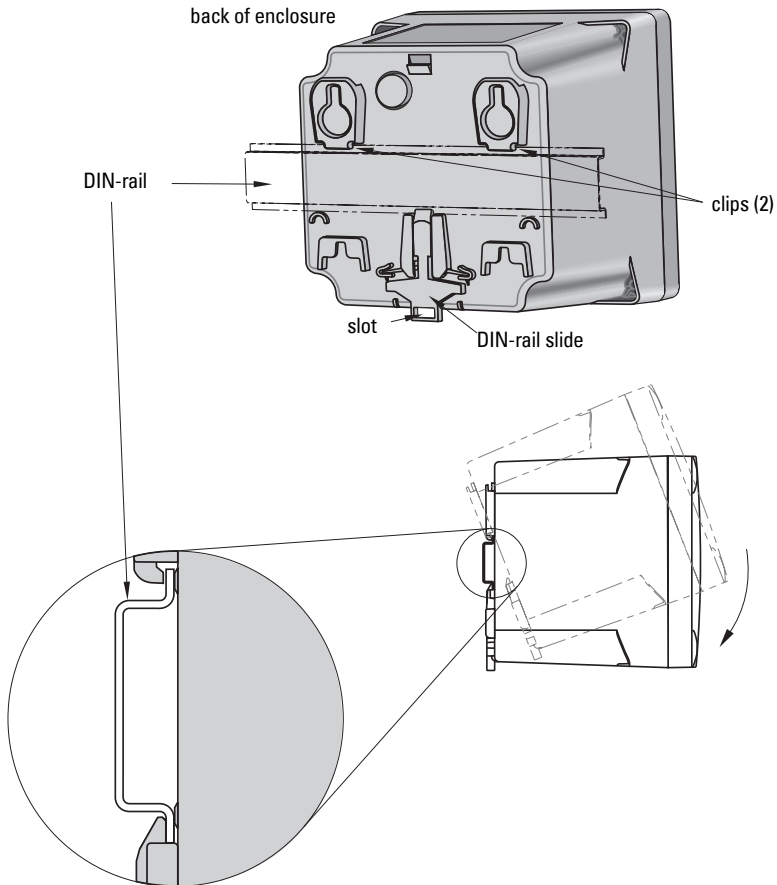

For a more detailed dimension drawing, see *SITRANS LUT400 Dimensions* on page 253.

Mounting the enclosure

1. Angle top of enclosure toward DIN-rail, and position slightly above top of rail.
2. Move enclosure downward against DIN-rail to hook clips on back of enclosure to top of DIN-rail.
3. Press device flush against DIN-rail to engage DIN-rail slide, which will fasten enclosure securely to DIN-rail.

Please note:

- Recommended mounting: directly to horizontal DIN-rail.
- Required DIN-rail dimensions: TH 35-7.5 or TH 35-15 per standard IEC 60715.
- The DIN-rail **MUST** be able to support four times the weight of the SITRANS LUT400.

Removing the enclosure

1. From the front of the device, place screwdriver in slot at bottom of DIN-rail slide and pry downward. This will unclip slide from bottom of DIN-rail.
2. While holding slide down, push upward on enclosure to release clips from top of DIN-rail.

Preparation for cable entry

Cables can be routed through conduit or enter the enclosure through cable glands. Follow steps 1 to 5 below to first uncover cable entry holes, then complete steps for use with conduit, or with cable glands.

1. Ensure enclosure lid is closed and fastener screws are locked.
2. Place tip of screwdriver into groove on the outer diameter of the knock-out tab (see illustration that follows).
3. Hit the end of the screwdriver with palm of hand to knock out entry hole.
4. Loosen screws and remove enclosure lid.
5. Remove plastic piece(s) that covered entry holes from enclosure. Be careful not to damage the electronics with static electricity, or the tools used to knock out entry holes.

Cable routed through conduit

(continued from steps 1 to 5 above)

6. After preparing for cable entry in steps 1 to 5 above, attach the conduit to the enclosure using only suitable size fittings approved for water-tight applications. (Conduit size is 1/2" NPT.)
7. Replace enclosure lid and tighten screws.

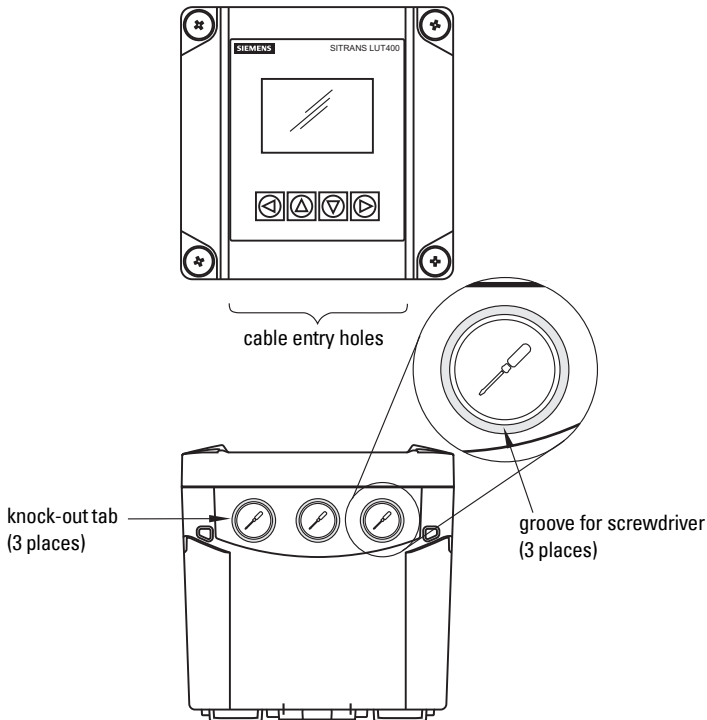

For a more detailed dimension drawing, see *SITRANS LUT400 Dimensions* on page 253.

Cable exposed and entering through the cable glands

(continued from steps 1 to 5 on previous page)

6. After preparing for cable entry in steps 1 to 5 above, unscrew the glands and attach them firmly to the enclosure.
7. Thread the cables through the glands. Ensure the power cable is kept separated from the signal cables and then wire the cables to the terminal blocks.
8. Tighten the glands to form a good seal.
9. Replace enclosure lid and tighten screws.

Notes:

- When cable entry hole knock-out tabs have been removed, the entry hole is 21.4 mm to 21.6 mm in diameter.
- M20 cable glands (20 mm in diameter), and 1/2" NPT conduit (21.3 mm in diameter) fit this entry hole.
- Caution should be taken when selecting appropriate seal for entry holes. Flat gasket is recommended (instead of O-ring). If alternate cable glands are used, it is the customer's responsibility to maintain IP65 rating of entry holes.

SITRANS LUT400 wiring compartment

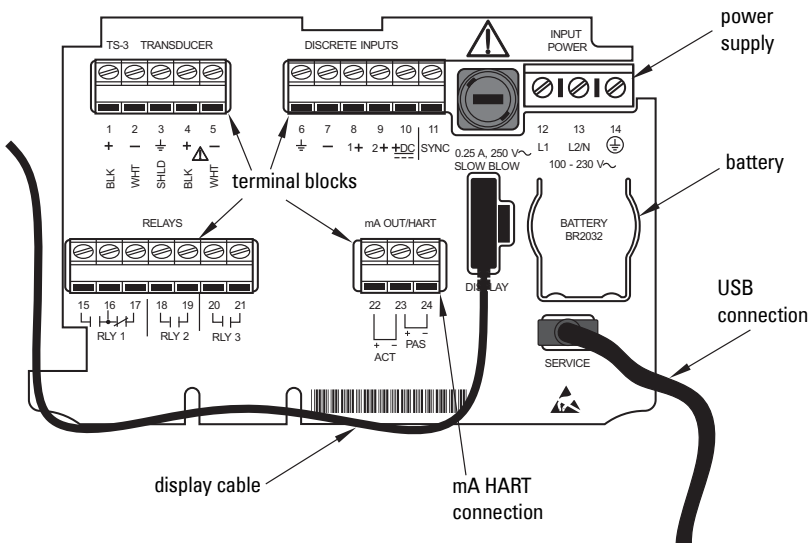

The Battery

The SITRANS LUT400 is supplied with one battery installed. The battery (BR2032) has a life expectancy of ten years, and is affected by ambient temperature. If the LUT400 loses input power, the battery will maintain operation of the device's real time clock until power has been restored.

When the battery reaches its end of life, refer to *Replacing the Battery* on page 226.



Disconnect power before replacing the battery.

Notes

Safety notes for connection

- Verify that all system components are installed in accordance with instructions.
- Connect all cable shields to the LUT400 shield terminals (denoted on device with symbol \perp). To avoid differential ground potentials ensure cable shields are properly connected to ground.
- Keep exposed conductors on shielded cables as short as possible to reduce noise on the line caused by stray transmissions and noise pickup.

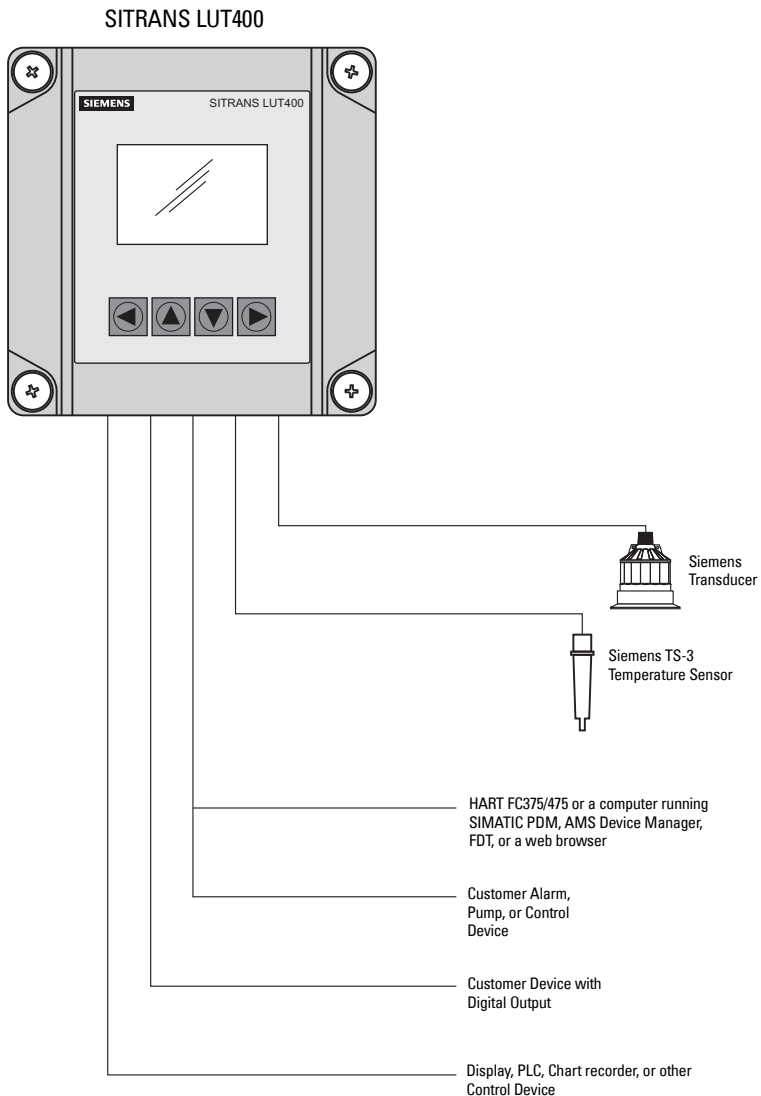

Connecting SITRANS LUT400



WARNINGS:

- Check the device label on your instrument, to verify the approval rating.
- Use appropriate conduit seals to maintain IP or NEMA rating.

Notes:

- Separate cables and conduits may be required to conform to standard instrumentation wiring practices or electrical codes.

To access the wiring compartment:

1. Loosen 1/4 turn locking screws.
2. Lift lid up and to the left on its hinges.
3. The lid can remain open connected by hinges, or it can be unclipped from the hinges and set to one side, to access wiring compartment.

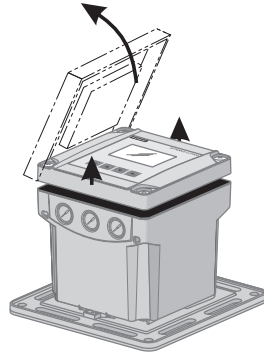

4. Make all connections as per instructions that follow.
5. When wiring complete, replace device lid.
6. Tighten locking screws.

Wiring compartment

The terminal board on the LUT400 allows all inputs and outputs to be connected simultaneously. Terminal strips can be removed to improve ease of wiring.

CAUTION: Ensure the terminal strips are terminated to the correct location during re-installation. Failure to do so may result in damage to the device, or external equipment that is attached.

Note: Recommended torque on terminal clamping screws.

- 0.56 - 0.79 N m
- 5 - 7 in-lbs

Please do not overtighten the screws.

WARNINGS:



The DC input terminals shall be supplied from a source providing electrical isolation between the input and output, in order to meet the applicable safety requirements of IEC 61010-1.



All field wiring must have insulation ratings suitable for the application.

Important!

Before applying power to the SITRANS LUT400 for the first time, ensure any connected alarm/control equipment is disabled until satisfactory system operation and performance is verified.

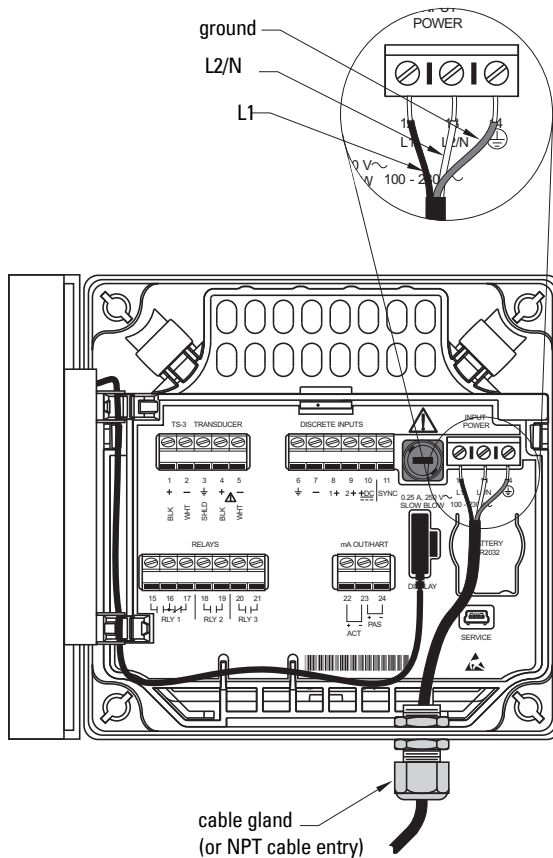

The SITRANS LUT400 is available in AC or DC power models.

AC Power

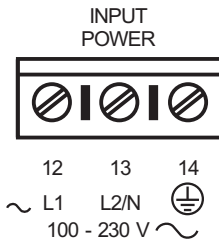

DC Power

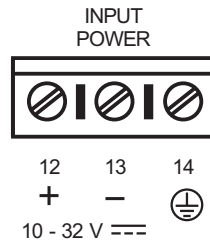

AC: 100-230 V AC \pm 15%, 50/60 Hz, 36 VA (10W) **DC:** 10-32 V DC, 10W

Note: Make sure device is connected to a reliable ground.



1. To wire for power, strip the cable jacket for approximately 70 mm (2.75") from the end of the cable, and thread the wires through the gland¹.
2. Connect the wires to the terminals as shown: the polarity is identified below the terminal block.
3. Ground the device according to local regulations.

Notes for AC power connections:

- The equipment must be protected by a 15 A fuse, or circuit breaker on all current-carrying conductors in the building installation.
- A circuit breaker or switch in the building installation, marked as the disconnect switch, must be in close proximity to the equipment and within easy reach of the operator, and must disconnect all current-carrying conductors.

Cables

The SITRANS LUT400 is designed to work with two conductor shielded transducer cables.

Connection	Cable Type
mA output, sync, Temperature sensor, discrete input	2 copper conductors, twisted, with shield ^a /drain wire, 300V 0.324 - 0.823 mm ² (22 - 18 AWG). Maximum length: 365 m
Transducer	Shielded two-wire.
	 Warning: Do not use a coaxial transducer cable extension with the SITRANS LUT400. High voltage transmitted on shield of coaxial cable could result in personal injury, damage to equipment, or poor device performance.
Relay output AC input	Copper conductors per local requirements.

a. Preferred shielding is braided shield.

1. If cable is routed through conduit, use only approved suitable-size hubs for waterproof applications.

Transducers



Warning: Hazardous voltage present on transducer terminals during operation.

Run the transducer cable in a grounded metal conduit, separate from other wiring (except TS-3 temperature sensor wiring, if applicable).

Notes:

- Do not use coaxial cable with SITRANS LUT400 due to high voltage transmitted on shield of coaxial cable
- Do not connect the LUT400 shield and white transducer wires together; wire to separate terminals

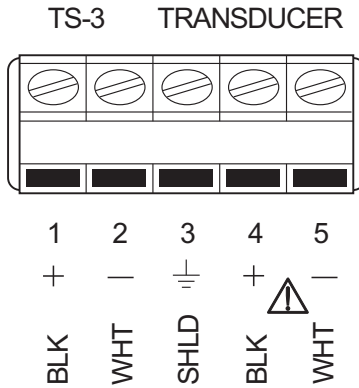

Temperature sensor

The speed of sound changes as temperature changes. To ensure accurate level measurement, the SITRANS LUT400 compensates via an external temperature input. All Siemens EchoMax transducers have an internal temperature sensor for this purpose, and for the fastest temperature response, Siemens also offers a dedicated temperature sensor, the TS-3.

If the following conditions apply, a separate TS-3 temperature sensor will ensure optimum accuracy:

- the transducer is exposed to direct sunlight (or other radiant heat source)
- the temperature of the atmosphere between the transducer face and monitored surface differs from the temperature of the transducer
- faster response to temperature changes is required.

To achieve the best performance of temperature measurement in a typical open channel flow application, the temperature sensor should be shielded from direct sunlight and mounted half way between the ultrasonic transducer face and the maximum head achievable in the application. Care should be taken to not obstruct the direct sound path of the ultrasonic transducer.

Note: Use a TS-3 Temperature Sensor only. Leave terminals open (unused) if TS-3 is not deployed.

Relays

Relay contacts are shown in the de-energized position. All relays can be configured as positive or negative logic (see 2.8.11. Relay Logic).

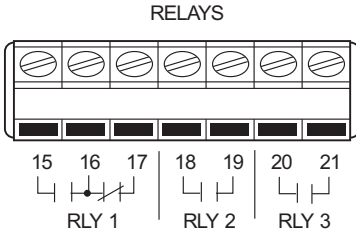

Power Failure

Relays 2, 3 are normally open.
 Relay 1 can be wired either normally open or normally closed.
 In the event of loss of input power, relays will revert to their normal states.

Relay Ratings

- one Form **C** (NO or NC) relay (relay 1), 1A at 250 V AC, non-inductive, 3A at 30 V DC
- two Form **A** (NO) relays (relays 2,3), 5A at 250 V AC, non-inductive, 3A at 30 V DC

Communications

The USB port and the 4 to 20 mA HART terminal block (terminal numbers 22, 23, and 24) are located inside the enclosure of the device.

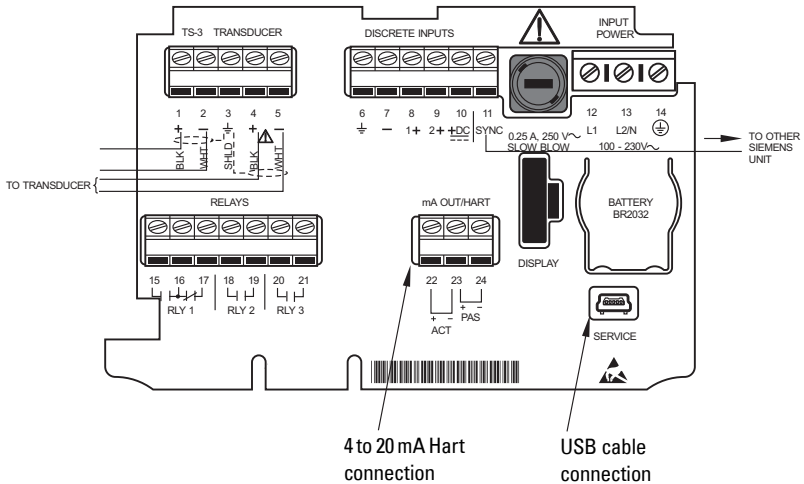

Connecting via USB

Typical USB configuration

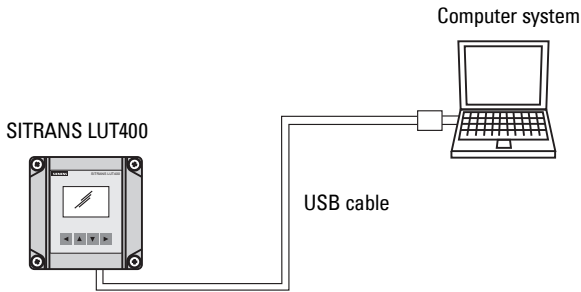

USB connection

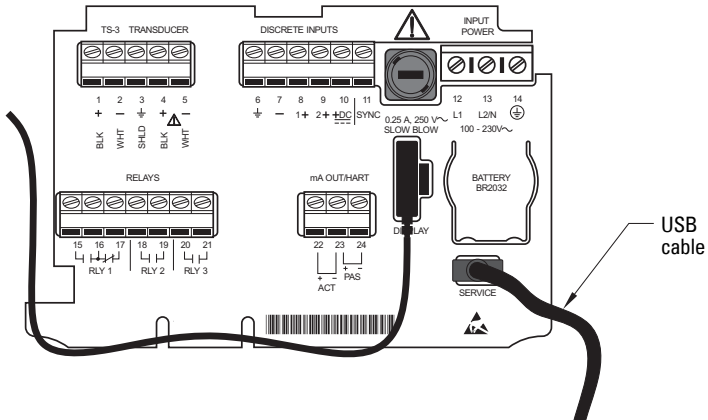

Use 5-pin USB Mini-B cable. The cable should not exceed 3 m (9.8 ft.).

Notes:

- No data logs are written while device is connected to a PC via USB. (See 2.10. **Data Logging** on page 173 and 3.2.6. **View Logs** on page 201.) Connect USB cable for device configuration, and when configuration is complete, disconnect the USB cable to allow Data Logging to occur. (It is good practice to use MS Windows *Safely Remove Hardware* feature before unplugging any USB cable from your computer.)
- Do not use a USB *extension* cable with the LUT400. Data Logging may not occur, even after extension cable has been disconnected. (If a USB extension cable has been used in error, a power reset of the device is required to restart Data Logging.)

Connecting HART

Typical PLC/mA configuration with Passive HART connection

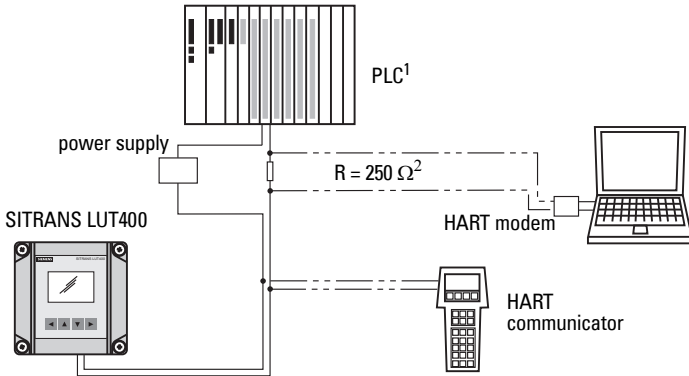

Typical PLC/mA configuration with Active HART connection

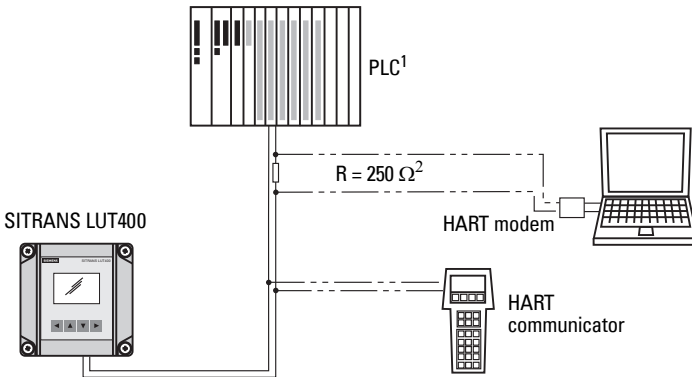

mA Output (HART)

For **ACTIVE** HART connection (using LUT400 integral power supply), connect terminals 22 and 23.

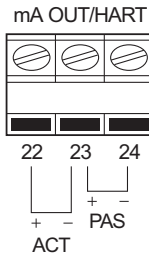

For **PASSIVE** HART connection (using external power supply), connect terminals 23 and 24.

For more information, consult the mA output parameters (2.5. Current Output) in the parameter reference section.

1. Depending on the system design, the power supply may be separate from the PLC, or integral to it.
2. The nominal value for the HART resistor is 250 Ohm. For more information see application guide *Working with HART*, which can be downloaded from the product page of our website. Go to: www.siemens.com/sitransLUT400 under **Support** and click on **Application Guides**.

Level system synchronization

Note: The SITRANS LUT400 CANNOT be synchronized with the MultiRanger Plus, the original HydroRanger, or the OCMIII.

When using multiple ultrasonic level monitors, be sure to run the transducer cables in separate grounded metal conduits.

When separate conduits are not possible, synchronize the level monitors so that no device transmits while another is waiting for echo reception. If more than one ultrasonic device is being installed in the same application, the devices must be synchronized to prevent cross-talk.

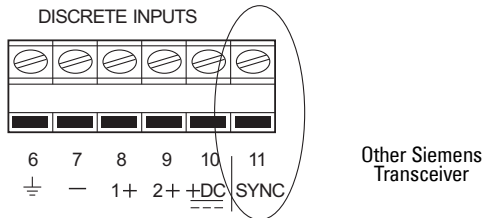

Synchronizing with another SITRANS LUT400, or other Siemens devices

Other Siemens devices that can be synchronized with the SITRANS LUT400:

DPL+, SPL, XPL+, LU01, LU02, LU10, LUC500, DPS300, HydroRanger 200, HydroRanger Plus, EnviroRanger, MiniRanger, MultiRanger 100/200

- Mount the level monitors together in one cabinet
- Use a common power (mains) supply and ground (earth) for all devices
- Interconnect the SYNC terminals of all level monitors.

For more information or assistance, contact Siemens or your local distributor. Go to: www.siemens.com/processautomation.

Discrete inputs

The SITRANS LUT400 has a 24V power bias (terminal 10) for use with the discrete inputs, or the discrete inputs can be wired using external power.

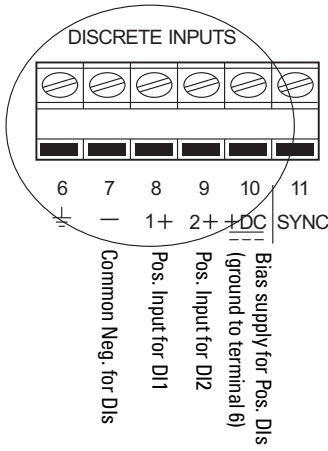

Discrete Inputs used with internal bias supply

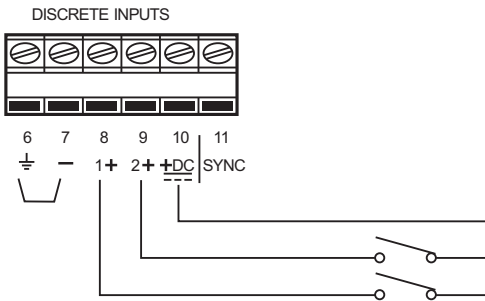

Note: terminals 6 and 7 must be connected together.

Discrete Inputs used with external bias voltage

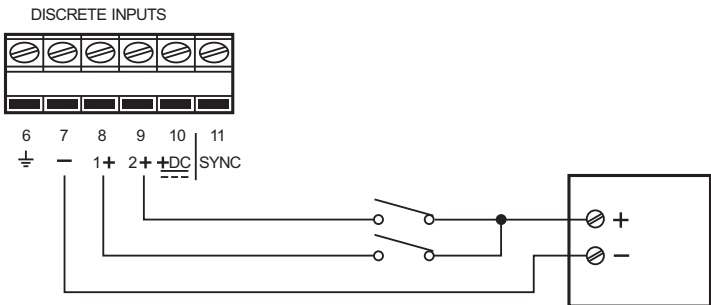

Remote mounted lid with extension cable

The optional display lid can be mounted remotely up to 5 m from the device. The optional extension cable can be used for such an installation.

1. Remove display lid from the enclosure.
2. Carefully disconnect the existing display cable from the terminal board.
3. Separate from the device, knock out cable entry tab on blank lid:
 - a. With gasket in place, use snips to cut into lid on both sides of the cable entry knockout. Use cutting guideline to cut from bottom of lid, up to bottom of groove (as shown below).
 - b. Once both sides of knockout have been cut through all layers of the lid (including the gasket), pry upward with pliers on knockout to snap off plastic and uncover cable entry hole.

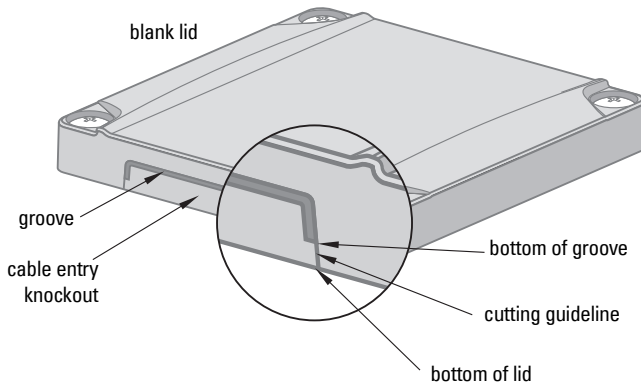

- c. Use sand paper if necessary to smooth any sharp edges.
- d. Replace the blank lid on the enclosure.



WARNINGS:

- Ingress protection of the enclosure is reduced to IP20, and Type 4X / NEMA 4X rating is void when cable entry knock-out in the blank lid is removed.
- An enclosure reduced to an IP20 rating and intended for use in non-hazardous locations must be installed in an indoor location free of dust and moisture, or be installed in a suitably rated field enclosure IP54 or better.

4. Connect the extension cable to the display connector on the terminal board. (If desired, attach second extension cable to the other end of the first extension cable.)
5. Feed the free end of the extension cable through cable entry hole on blank lid.
6. Connect extension cable to display cable on remote lid.

- Secure blank lid on device and mount display lid remotely. See *Remote mounted lid* on page 12 for mounting instructions.

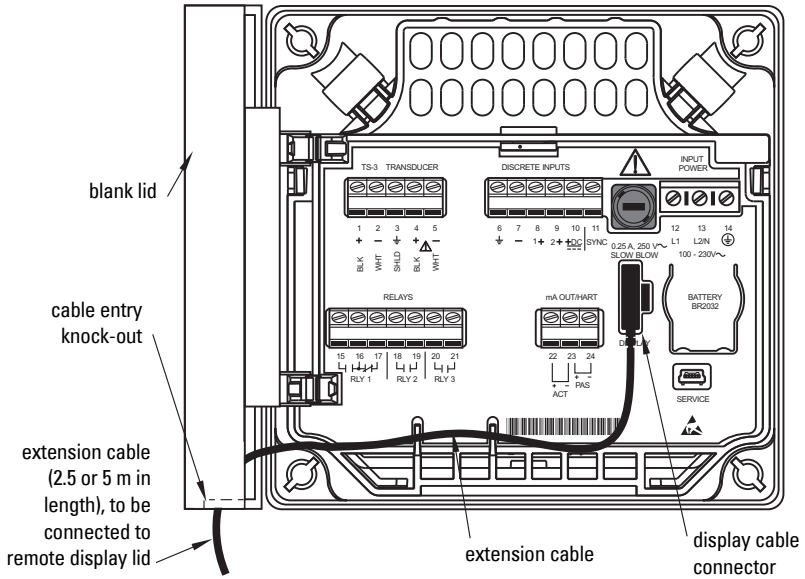

Extension cable

Optional extension cables (2.5 m cables) are available to be used with remote mounted lid. Two cables can be connected together for an extension of up to 5 meters.

Note: It is recommended that the exposed extension cable be secured along a wall, or run through conduit to prevent damage to device, should cable be accidentally subjected to stress.

Connecting in hazardous area installations



Wiring setups for hazardous area installations



The following wiring options are available for hazardous area installations:



- Non-incendive wiring (Canada)



In all cases, check the device label on your instrument, and confirm the approval rating.



1. Non-incendive wiring (Canada)



SIEMENS	
SITRANS LUT420 7ML0000-xxxxxx-xxxx Serial No.: GYZ / B1034567 Power Rating: 100 – 230V \sim ± 15% 50/60 Hz, 36 VA (10 W) Contact Rating: 1A/5A @ 250V \sim , Non-Inductive Operating Temperature: – 20°C to 50°C Enclosure: IP65 / TYPE 4X / NEMA 4X	
 Class I, Div.2, Gr. A, B, C & D T3C Class II, Div.2, Gr. F & G Class III 159134 Per Drawing A5E03936871	
Siemens Milltronics Process Instruments, Peterborough Assembled in Canada with domestic and imported parts	

SIEMENS	
SITRANS LUT430 7ML0000-xxxxxx-xxxx Serial No.: GYZ / B1034567 Power Rating: 100 – 230V \sim ± 15% 50/60 Hz, 36 VA (10 W) Contact Rating: 1A/5A @ 250V \sim , Non-Inductive Operating Temperature: – 20°C to 50°C Enclosure: IP65 / TYPE 4X / NEMA 4X	
 Class I, Div.2, Gr. A, B, C & D T3C Class II, Div.2, Gr. F & G Class III 159134 Per Drawing A5E03936871	
Siemens Milltronics Process Instruments, Peterborough Assembled in Canada with domestic and imported parts	

SIEMENS	
SITRANS LUT440 7ML0000-xxxxxx-xxxx Serial No.: GYZ / B1034567 Power Rating: 100 – 230V \sim ± 15% 50/60 Hz, 36 VA (10 W) Contact Rating: 1A/5A @ 250V \sim , Non-Inductive Operating Temperature: – 20°C to 50°C Enclosure: IP65 / TYPE 4X / NEMA 4X	
 Class I, Div.2, Gr. A, B, C & D T3C Class II, Div.2, Gr. F & G Class III 159134 Per Drawing A5E03936871	
Siemens Milltronics Process Instruments, Peterborough Assembled in Canada with domestic and imported parts	

SIEMENS	
SITRANS LUT420 7ML0000-xxxxxx-xxxx Serial No.: GYZ / B1034567 Power Rating: 10 – 32V \equiv , 10W Contact Rating: 1A/5A @ 250V \sim , Non-Inductive Operating Temperature: – 20°C to 50°C Enclosure: IP65 / TYPE 4X / NEMA 4X	
 Class I, Div.2, Gr. A, B, C & D T3C Class II, Div. 2, Gr. F & G Class III 159134 Per DWG. A5E03936871	
Siemens Milltronics Process Instruments, Peterborough Assembled in Canada with domestic and imported parts	

SIEMENS	
SITRANS LUT430 7ML0000-xxxxxx-xxxx Serial No.: GYZ / B1034567 Power Rating: 10 – 32V \equiv , 10W Contact Rating: 1A/5A @ 250V \sim , Non-Inductive Operating Temperature: – 20°C to 50°C Enclosure: IP65 / TYPE 4X / NEMA 4X	
 Class I, Div.2, Gr. A, B, C & D T3C Class II, Div. 2, Gr. F & G Class III 159134 Per DWG. A5E03936871	
Siemens Milltronics Process Instruments, Peterborough Assembled in Canada with domestic and imported parts	

SIEMENS	
SITRANS LUT440 7ML0000-xxxxxx-xxxx Serial No.: GYZ / B1034567 Power Rating: 10 – 32V \equiv , 10W Contact Rating: 1A/5A @ 250V \sim , Non-Inductive Operating Temperature: – 20°C to 50°C Enclosure: IP65 / TYPE 4X / NEMA 4X	
 Class I, Div.2, Gr. A, B, C & D T3C Class II, Div. 2, Gr. F & G Class III 159134 Per DWG. A5E03936871	
Siemens Milltronics Process Instruments, Peterborough Assembled in Canada with domestic and imported parts	

CSA Class I, Div 2 connection drawing number A5E03936871 can be downloaded from the product page of our website at www.siemens.com/sitransLUT400.

Notes

Commissioning

Local Commissioning

SITRANS LUT400 is an easy to use, and quick to commission device, with its numerous wizards, and menu driven parameters. The parameters can be modified locally using the LCD and the local push buttons, also known as the Local User Interface (LUI).

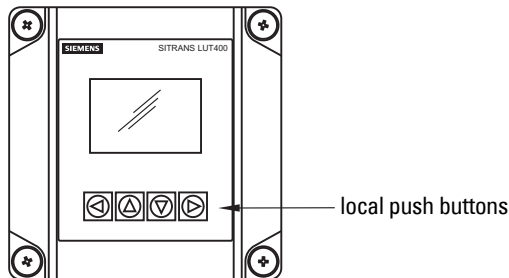

A Quick Start Wizard provides an easy step-by-step procedure to help you configure the device for a simple application. We recommend that you configure your application in the following order:

- First, run the appropriate Quick Start Wizard for your application (Level, Volume, Flow).
- Next, setup pumps via the Pump Control Wizard (if applicable).
- Lastly, configure alarms, or other controls, totalizers and samplers, referencing the respective parameters [see *Parameter reference (LUI)* on page 137]. It is important that alarms, and other controls are configured last to avoid pump relay assignments being overridden by the Quick Start Wizard.

There are two ways to access the Quick Start wizards:

- locally (see *Quick Start Wizards via LUI* on page 38)
- from a remote location (see *Other Quick Start Wizards (QSW):* on page 38)

See *Level Application Example* on page 58, or *Flow application example* on page 59 for illustrations, and for the complete range of parameters, see *Parameter reference (LUI)* on page 137.

Activating SITRANS LUT400

Notes:

- Program Mode and Measurement mode refer to the display only. While the device is in Program mode, the output remains active and continues to respond to changes in the device.
- To enter Program mode using the device local push buttons, press ►. Press ◀ to return to Measurement mode.
- The display will return to Measurement mode after ten minutes of inactivity (from last button press), when in Program Mode and from within a Wizard. Pressing ► will then take you to the main navigation menu. (It will not return to the screen from which the timeout occurred.)

1. Power up the device. SITRANS LUT400 automatically starts up in Measurement mode. A transition screen showing first the Siemens logo and then the current firmware revision of the LUI is displayed while the first measurement is being processed.
2. The first time the device is configured, you will be prompted to select a language (English, German, French, Spanish or Chinese). To change the language again (after initial setup), see *Language* on page 217.
3. Device time is set to Eastern Standard Time (EST) at the factory. To modify, see *Date and Time* on page 187. The correct date and time should be set prior to configuring the device.

The LCD Display

Measurement mode display: Normal operation

Level

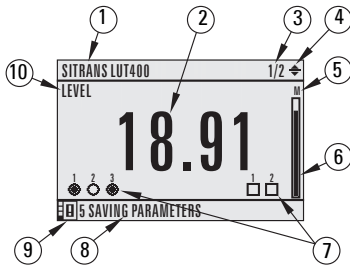

1 – tag

2 – measured value (level, space, distance, volume, flow, or head)

3 – value being displayed [Primary Variable (PV)=1 of 2, Secondary Variable (SV)=2 of 2]

4 – toggle indicator¹ for PV or SV

5 – units

6 – bar graph indicates level

7 – secondary region indicates configured relays (left) and discrete inputs (right)

8 – text area displays status messages

9 – device status indicator

10 – selected (primary) sensor mode: level, space, distance, volume, head, or flow

Flow

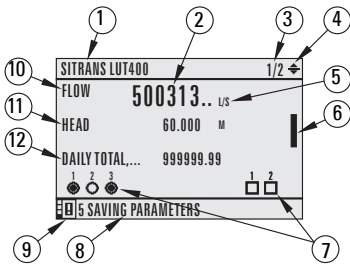

11 – secondary sensor mode = head when primary sensor mode = flow

12 – totalizer values: display alternates between daily totalizer and running totalizer

Fault present



8 – text area displays a fault code and an error message

9 – service required icon appears

¹. Press UP or DOWN arrow to switch

PROGRAM mode display

Navigation view

- A visible menu bar indicates the menu list is too long to display all items.
- The depth of the item band on the menu bar indicates the length of the menu list: a deeper band indicates fewer items.
- The position of the item band indicates the approximate position of the current item in the list. A band filled halfway down the menu bar indicates the current item is halfway down the list.

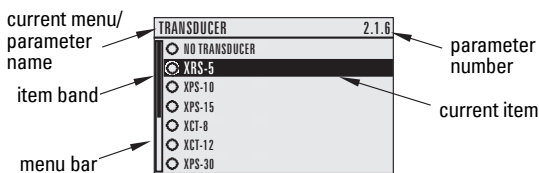

Parameter view

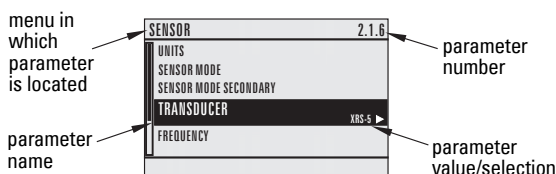

Edit view

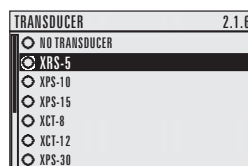

Key functions in Measurement mode

Key	Function	Result
	RIGHT arrow opens PROGRAM mode.	Opens the top level menu.
	UP or DOWN arrow toggles between PV and SV.	LCD displays primary or secondary value.

Programming SITRANS LUT400

Notes:

- To enter Program mode using the device local push buttons, press . Press to return to Measurement mode.
- While the device is in Program mode, the output remains active and continues to respond to changes in the device.

Change parameter settings and set operating conditions to suit your specific application. (For remote operation, see *Operation via SIMATIC PDM 6 (HART)* on page 127 or *Operation via AMS Device Manager (HART)* on page 131.)

Parameter menus

Note: For the complete list of parameters with instructions, see *Parameter reference (LUI)* on page 137.

Parameters are identified by name and organized into function groups, then arranged in a 5-level menu structure, as in the example below. (For full menu see *LCD Menu Structure* on page 273.)



```

1. WIZARDS
2. SETUP
  2.1 SENSOR
  .....
  2.7 PUMPS
    2.7.1 BASIC SETUP
    2.7.2 MODIFIERS
      2.7.2.1 WALL CLING REDUCTION
        2.7.2.1.1 ENABLE
  
```

1. Enter PROGRAM mode





Using local push buttons:

- **RIGHT arrow** ► activates PROGRAM mode and opens menu level 1.

2. Navigating: key functions in Navigation view

Notes:

- In Navigation view, **ARROW keys** move to the next menu item in the direction of the arrow.
- Press and hold any arrow key to scroll through a list of options or menus (in the direction of the arrow).

Key	Name	Menu level	Function
 	UP or DOWN arrow	menu or parameter	Scroll to previous or next menu or parameter.
	RIGHT arrow	menu	Go to first parameter in the selected menu, or open next menu.
		parameter	Open Edit mode.
	LEFT arrow	menu or parameter	Open parent menu.

3. Editing in PROGRAM mode

Selecting a listed option

- Navigate to the desired parameter.
- Press **RIGHT arrow** ► to open **Edit** mode. The current selection is highlighted.
- Scroll to a new selection.
- Press **RIGHT arrow** ► to accept it. The LCD returns to parameter view and displays the new selection.

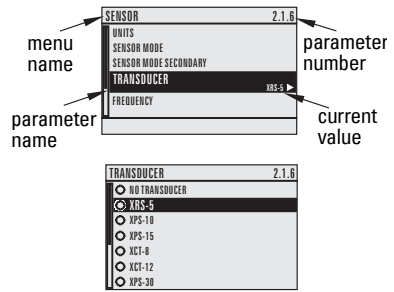



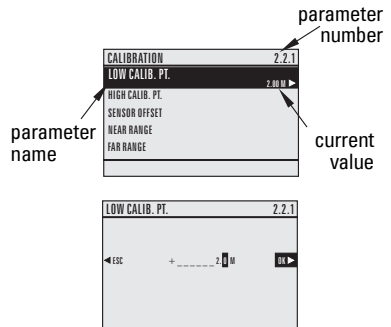

Changing a numeric value

- Navigate to the desired parameter.
- When selected, the current value is displayed.
- Press **RIGHT arrow** ► to open **Edit** mode. The cursor position is highlighted.
- Use **LEFT** ◀ and **RIGHT arrow** ► to move cursor to digit position you wish to change.
- As each digit is highlighted (selected), use the **UP** ▲ and **DOWN arrow** ▼ to increase or decrease the digit respectively.
- While decimal point is selected, use **UP** ▲ and **DOWN arrow** ▼ to shift decimal position.
- To escape without saving your changes, press **LEFT arrow** ◀ continually until **ESC** is highlighted. Press **LEFT arrow** ◀ again to escape without saving changes. Otherwise, when new parameter value is correct, press **RIGHT arrow** ► continually until **OK** is highlighted.
- Press **RIGHT arrow** ► to accept the new value. The LCD returns to parameter view and displays the new selection. Review for accuracy.



Key functions in Edit mode

Key	Name	Function
 	UP or DOWN arrow	Selecting options
		Alpha-numeric editing
		Scrolls to item. - Increments or decrements digits - Toggles plus and minus sign

Key	Name	Function (Continued)	
	RIGHT arrow	Selecting options	- Accepts the data (writes the parameter) - Changes from Edit to Navigation mode
		Numeric editing	- Moves cursor one space to the right - or with selection highlighted, accepts the data and changes from Edit to Navigation mode
	LEFT arrow:	Selecting options	Cancels Edit mode without changing the parameter
		Numeric editing	- Moves cursor to plus/minus sign if this is the first key pressed - or moves cursor one space to the left. - or with cursor on Enter sign, cancels the entry

Quick Start Wizards

A Wizard provides an easy step-by-step Quick Start (QS) procedure that configures the device for a simple application. To configure the SITRANS LUT400 for applications of level, volume (standard vessel shapes), or flow, use the *Quick Start Wizards via LUI* on page 38 of this chapter.

Wizards for applications employing more complex vessel shapes are available via SIMATIC PDM. See *Quick Start (Volume - Linearization)* in the LUT400 Communications manual¹.

Other Quick Start Wizards (QSW):

Other Quick Start Wizards using various software packages are also available:

- SIMATIC PDM (HART) (see page 127)
- AMS (HART) (see page 131)
- FC375/475 (HART) (see page 133)
- FDTs (HART) (see page 135)

Before initiating a Quick Start Wizard to configure the device, you may wish to gather the necessary parameter values. Parameter Configuration Charts that list all parameters and available options for each application type are available on our website. Go to www.siemens.com/sitransLUT400 > **Support** > **Application Guides**. You can record data and select from options on the chart that apply to your application, then with this data on hand, complete the *Quick Start Wizards via LUI* below, or via another Quick Start Wizard, as referenced above.

Quick Start Wizards via LUI

- 1) Press  to enter Program mode.

Note: Device continues to measure while in Program Mode. If you wish to disable the device while it is configured, see *3.3.1. Transducer Enable* on page 203.

¹ Communications for SITRANS LUT400 (HART) Manual (7ML19985NE01). (See DVD shipped with device or download manual from our website.)

- 2) Choose Wizards (1.), Quick Start (1.1), and then the appropriate quick start: QS Level (1.1.1.), QS Volume (1.1.2.), or QS Flow (1.1.3.). [The QS Flow wizard will display on LUI for LUT430 (Pump and Flow), and LUT440 (OCM) configured models only.]
- 3) Follow the steps then choose **Finish** to save Quick Start parameter changes and return to Program menu, then press **◀** three times to return to Measurement mode.

Notes:

- The Quick Start Wizard settings are inter-related and changes apply only after you choose Finish in the final step.
- Perform customization for your application only after the Quick Start has been completed.

1. Wizards

1.1. Quick Start

1.1.1. QS Level

Use this wizard to configure simple level applications.

- a. Press **RIGHT arrow ▶** to activate PROGRAM mode and open menu level 1: MAIN MENU.
- b. Press **RIGHT arrow ▶** two times to navigate to menu item 1.1.1.
- c. Press **RIGHT arrow ▶** to open QS Level.
- d. At each step, press **DOWN arrow ▼** to accept default values and move directly to the next item,
or **RIGHT arrow ▶** to open Edit mode: the current selection is highlighted.
- e. Scroll to desired item and press **RIGHT arrow ▶** to store the change, then press **DOWN arrow ▼** to continue.
- f. At any time, you can press **UP arrow ▲** to go back, or **LEFT arrow ◀** to cancel the wizard.

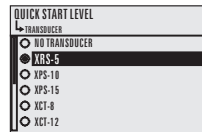
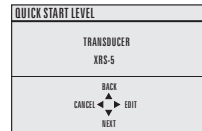

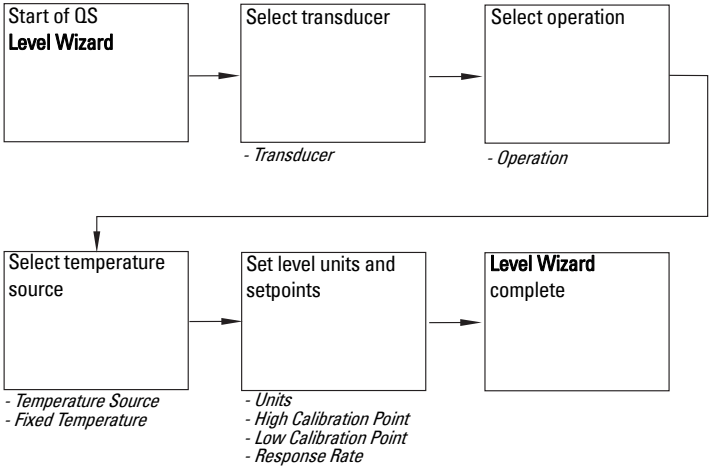

Start of QS Level Wizard

Note: The introduction screen is displayed only on the device when using the local push buttons. This screen is not part of the Quick Start when using SIMATIC PDM.

Shows the type of Wizard to be executed.

Options	CANCEL, START
----------------	---------------

Transducer

Specifies the Siemens transducer connected to the device.

Options	NO TRANSDUCER, XRS-5, XPS-10, XPS-15, XCT-8, XCT-12, XPS-30, XPS-40, XLT-30, XLT-60, STH
	Default: NO TRANSDUCER

Operation

Sets the type of measurement (and the corresponding mA output) required for the application.

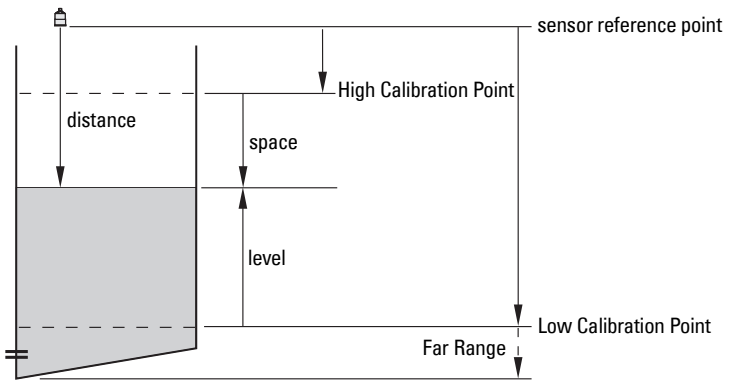

Mode		Description	Reference point
LEVEL	*	Height of material	Low Calibration Point (process empty level)
SPACE		Distance to material surface	High Calibration Point (process full level)
DISTANCE			Sensor Reference Point
OTHER		Do NOT select. If Operation value displays as OTHER, the device is configured as a level controller, but has been set previously to a mode other than LEVEL, SPACE, or DISTANCE. The operation mode must be set to LEVEL, SPACE, or DISTANCE to proceed with the QS Level Wizard.	

Temperature Source

Source of the temperature reading used to adjust the speed of sound.

Options	TRANSDUCER, FIXED TEMPERATURE, EXTERNAL TS-3, AVERAGE OF SENSORS
	Default: TRANSDUCER

See *Temperature Source* on page 180 for more details.

Fixed Temperature

Use this feature if a temperature sensing device is not used.

Value	Range: -100.0 to +150.0 °C
	Default: +20.0 °C

This parameter is only displayed if **FIXED TEMPERATURE** selected for Temperature Source.

Units

Sensor measurement units.

Options	M, CM, MM, FT, IN
	Default: M

Note: For the purpose of this example, all values are assumed to be in meters (m).

High Calibration Point

Distance from Sensor Reference Point to High Calibration Point: usually process full level.

Value	Range: 0.000 to 60.000
	Default: 0.000

Low Calibration Point

Distance from Sensor Reference Point to Low Calibration Point: usually process empty level.

Value	Range: 0.000 to 60.000
	Default: 60.000

Response Rate

Sets the reaction speed of the device to measurement changes in the target range.

Notes:

- Response Rate can only be set through the Quick Start Wizard, and any changes made to Fill Rate per Minute (2.3.1.), Empty Rate per Minute (2.3.2.), or Damping Filter (2.3.3.) parameters following the completion of the wizard will supersede the Response Rate setting.
- **Response Rate** always displays in m/minute.

Options	SLOW (0.1 M/MIN)
	MEDIUM (1.0 M/MIN)
	FAST (10 M/MIN)
	Default: SLOW (0.1 M/MIN)

Use a setting just faster than the maximum filling or emptying rate (whichever is greater). Slower settings provide higher accuracy, faster settings allow for more rapid level fluctuations.

End of QS Level Wizard

For QS to be successful, all changes must be applied.

Options	BACK, CANCEL, FINISH (Display returns to 1.1 Quick Start menu when Quick Start is successfully completed or cancelled. If CANCEL is selected, no changes are written to the device.)
----------------	---

To transfer Quick Start values to the device and return to Program menu, press **DOWN arrow ▼ (Finish)**. Then press **LEFT arrow ◀** three times to return to Measurement mode.

1.1.2. QS Volume

Use this wizard to configure volume applications employing standard vessel shapes.

- Press **RIGHT arrow** ► to activate PROGRAM mode and open menu level 1: MAIN MENU.
- Press **RIGHT arrow** ► two times to navigate to menu item 1.1.1.
- Press **DOWN arrow** ▼ and **RIGHT arrow** ► to open QS Volume.
- At each step, press **DOWN arrow** ▼ to accept default values and move directly to the next item, or **RIGHT arrow** ► to open Edit mode: the current selection is highlighted.
- Scroll to desired item and press **RIGHT arrow** ► to store the change, then press **DOWN arrow** ▼ to continue.
- At any time, you can press **UP arrow** ▲ to go back, or **LEFT arrow** ◀ to cancel the wizard.

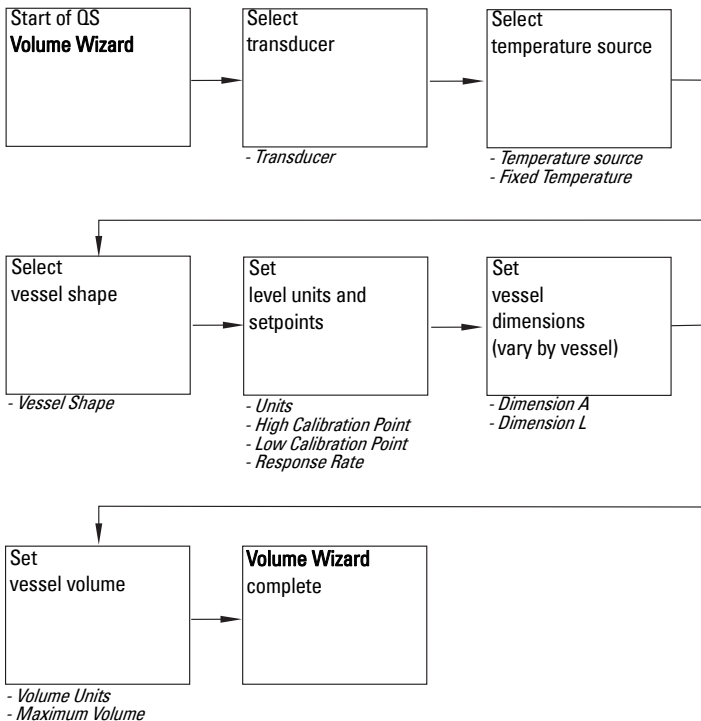
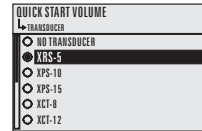
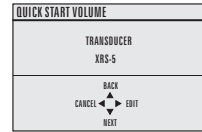

Start of QS Volume Wizard

Note: The introduction screen is displayed only on the device when using the local push buttons. This screen is not part of the Quick Start when using SIMATIC PDM.

Shows the type of Wizard to be executed.

Options	CANCEL, START
----------------	---------------

Transducer

Specifies the Siemens transducer connected to the device.

Options	NO TRANSDUCER, XRS-5, XPS-10, XPS-15, XCT-8, XCT-12, XPS-30, XPS-40, XLT-30, XLT-60, STH
	Default: NO TRANSDUCER

Temperature Source

Source of the temperature reading used to adjust the speed of sound.

Options	TRANSDUCER, FIXED TEMPERATURE, EXTERNAL TS-3, AVGERAGE OF SENSORS
	Default: TRANSDUCER

See *Temperature Source* on page 180 for more details.

Fixed Temperature

Use this feature if a temperature sensing device is not used.

Value	Range: -100.0 to +150.0 °C
	Default: +20.0 °C

This parameter is only displayed if **FIXED TEMPERATURE** selected for Temperature Source.

Vessel Shape

*Defines the vessel shape and allows the SITRANS LUT400 to calculate volume instead of level. If **NONE** is selected, no volume conversion is performed. Select the vessel shape matching the monitored vessel or reservoir.*

Options	NONE, LINEAR, CYLINDER, PARABOLIC BOTTOM, HALF SPHERE BOTTOM, FLAT SLOPED BOTTOM, PARABOLIC ENDS, SPHERE, CONICAL BOTTOM, CURVE TABLE, LINEAR TABLE
	Default: LINEAR

See *Vessel Shape* on page 147 for illustration. If CURVE TABLE or LINEAR TABLE selected, enter values for level and volume breakpoints after completing the wizard (see 2.6.7. Table 1-8 on page 150).

Units

Sensor measurement units.

Options	M, CM, MM, FT, IN
	Default: M

Note: For the purpose of this example, all values are assumed to be in meters (m).

High Calibration Point

Distance from Sensor Reference Point to High Calibration Point: usually process full level.

Value	Range: 0.000 to 60.000
	Default: 0.000

Low Calibration Point

Distance from Sensor Reference Point to Low Calibration Point: usually process empty level.

Value	Range: 0.000 to 60.000
	Default: 60.000

Response Rate

Sets the reaction speed of the device to measurement changes in the target range.

Notes:

- Response Rate can only be set through the Quick Start Wizard, and any changes made to Fill Rate per Minute (2.3.1.) or Empty Rate per Minute (2.3.2.) parameters following the completion of the wizard will supersede the Response Rate setting.
- **Response Rate** always displays in m/minute.

Options	SLOW (0.1 M/MIN)
	MEDIUM (1.0 M/MIN)
	FAST (10 M/MIN)
	Default: SLOW (0.1 M/MIN)

Use a setting just faster than the maximum filling or emptying rate (whichever is greater). Slower settings provide higher accuracy, faster settings allow for more level fluctuations.

Dimension A

The height of the vessel bottom when the bottom is conical, pyramidal, parabolic, spherical, or flat -sloped.

Value	Range: 0.000 to 99.999
	Default: 0.000

Dimension L

Length of the cylindrical section of a horizontal parabolic end vessel.

Value	Range: 0.000 to 99.999
	Default: 0.000

Volume Units

Determines volume measurement units.

Options	L, USGAL, IMPGAL, CUM, USER DEFINED *
	Default: L

* If **USER DEFINED** option selected, the value must be set after completing the wizard. See 2.6.6. *User Defined Unit* on page 149.

Maximum Volume

The maximum volume of the vessel. Enter the vessel volume corresponding to the High Calibration Point. For example, if your maximum vessel volume is 8000 L, enter a value of 8000.

Value	Range: 0.0 to 9999999
	Default: 100.0

End of QS Volume Wizard

For QS to be successful, all changes must be applied.

Options	BACK, CANCEL, FINISH (Display returns to 1.1 Quick Start menu when Quick Start is successfully completed or cancelled. If CANCEL is selected, no changes are written to the device.)
----------------	--

To transfer Quick Start values to the device and return to Program menu, press **DOWN arrow ▼ (Finish)**. Then press **LEFT arrow ◀** three times to return to Measurement mode.

1.1.3. QS Flow

Use this wizard to configure simple flow applications.
(Visible on LUT430 (Pump and Flow), and LUT440 (OCM) configured models only.)

- Press **RIGHT arrow** ► to activate PROGRAM mode and open menu level 1: MAIN MENU.
- Press **RIGHT arrow** ► two times to navigate to menu item 1.1.1.
- Press **DOWN arrow** ▼ two times and **RIGHT arrow** ► to open QS Flow.
- At each step, press **DOWN arrow** ▼ to accept default values and move directly to the next item,
or **RIGHT arrow** ► to open Edit mode: the current selection is highlighted.
- Scroll to desired item and press **RIGHT arrow** ► to store the change, then press **DOWN arrow** ▼ to continue.
- At any time, you can press **UP arrow** ▲ to go back, or **LEFT arrow** ◀ to cancel the wizard.

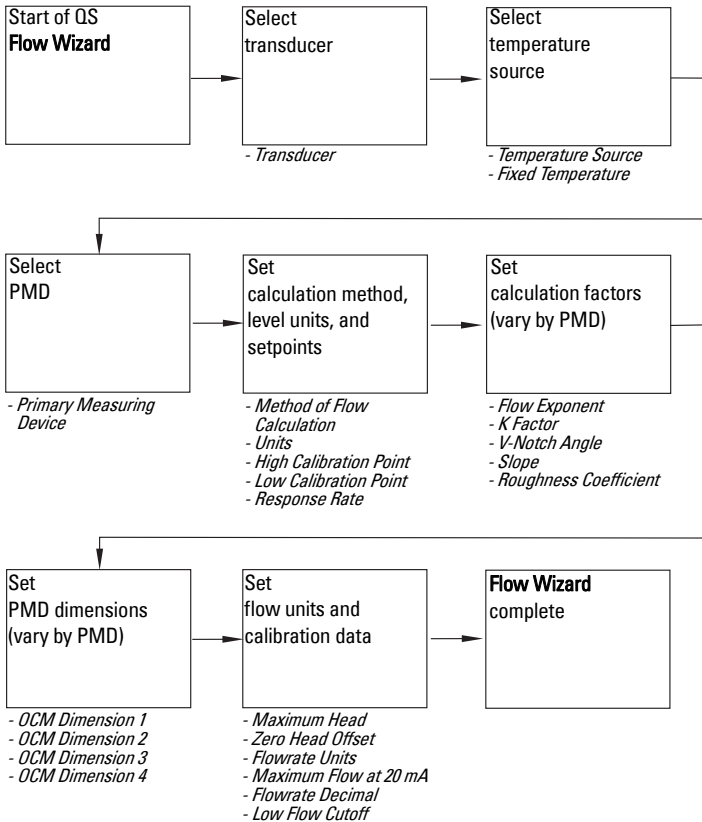
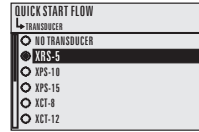
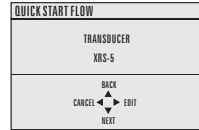

Start of QS Flow Wizard

Note: The introduction screen is displayed only on the device when using the local push buttons. This screen is not part of the Quick Start when using SIMATIC PDM.

Shows the type of Wizard to be executed.

Options	CANCEL, START
----------------	---------------

Transducer

Specifies the Siemens transducer connected to the device.

Options	NO TRANSDUCER, XRS-5, XPS-10, XPS-15, XCT-8, XCT-12, XPS-30, XPS-40, XLT-30, XLT-60, STH
	Default: NO TRANSDUCER

Temperature Source

Source of the temperature reading used to adjust the speed of sound.

Options	TRANSDUCER, FIXED TEMPERATURE, EXTERNAL TS-3, AVGERAGE OF SENSORS
	Default: TRANSDUCER

See *Temperature Source* on page 180 for more details.

Fixed Temperature

Source of the temperature reading used to adjust the speed of sound.

Value	Range: -100.0 to +150.0 °C
	Default: +20.0 °C

This parameter is only displayed if **FIXED TEMPERATURE** selected for Temperature Source.

Primary Measuring Device

Defines the primary measuring device (PMD) to be used in the application.

Options	EXPONENTIAL DEVICES, RECTANGULAR FLUME BS-3680, ROUND NOSE HORIZONTAL CR. BS-3680, TRAPEZOIDAL FLUME BS-3680, U-FLUME BS-3680, FINITE CREST WEIR BS-3680, THIN PLATE RECT. WEIR BS-3680, THIN PLATE V-NOTCH WEIR BS-3680, RECT. WEIR CONTRACTED, ROUND PIPE, PALMER BOWLUS FLUME, H-FLUME, OTHER*
	Default: EXPONENTIAL DEVICES

* Option will be set to **OTHER** if the wizard was run previously via HART software tool (such as SIMATIC PDM), and the device was set to **OFF** or **UNIVERSAL HEAD VS. FLOW**. If this is initial configuration, the PMD can only be set for no calculation (OFF), or for linearization (UNIVERSAL HEAD VS. FLOW) via HART software tools (SIMATIC PDM, AMS, FC375/475).

Method of Flow Calculation

Sets the method of flow calculation.

Options	ABSOLUTE, RATIOMETRIC
	Default: ABSOLUTE

Units

Sensor measurement units.

Options	M, CM, MM, FT, IN
	Default: M

Note: For the purpose of this example, all values are assumed to be in meters (m).

High Calibration Point

Distance from Sensor Reference Point to High Calibration Point: usually process full level.

Value	Range: 0.000 to 60.000
	Default: 0.000

Low Calibration Point

Distance from Sensor Reference Point to Low Calibration Point: usually process empty level.

Value	Range: 0.000 to 60.000
	Default: 60.000

Response Rate

Sets the reaction speed of the device to measurement changes in the target range.

Notes:

- Response Rate can only be set through the Quick Start Wizard, and any changes made to Fill Rate per Minute (2.3.1.) or Empty Rate per Minute (2.3.2.) parameters following the completion of the wizard will supersede the Response Rate setting.
- **Response Rate** always displays in m/minute.

Options	SLOW (0.1 M/MIN)
	MEDIUM (1.0 M/MIN)
	FAST (10 M/MIN)
	Default: SLOW (0.1 M/MIN)

Use a setting just faster than the maximum filling or emptying rate (whichever is greater). Slower settings provide higher accuracy, faster settings allow for more level fluctuations.

Calculation factors:

Notes:

- The following five parameters will display in the wizard based on the PMD selected above.
- These parameters are used in the flow calculation formula (see *Method of Flow Calculation* on page 266).

Flow Exponent

(PMD = EXPONENTIAL DEVICES)

The exponent for the flow calculation formula. (See Method of Flow Calculation on page 266.)

Value	Range: -999.000 to 9999.000
	Default: 1.550

K Factor

(PMD = EXPONENTIAL DEVICES)

The constant used in the flow calculation formula for absolute calculation of an exponential device only.

Value	Range: -999.000 to 9999.000
	Default: 1.000

V-Notch Angle

(PMD = THIN PLATE V-NOTCH WEIR)

The V-Notch angle used in the flow calculation formula.

Value	Range: 25.000 to 95.000
	Default: 25.000

Slope

(PMD = TRAPEZOIDAL FLUME or ROUND PIPE)

The Flow Slope used in the flow calculation formula.

Value	Range: -999.000 to 9999.000
	Default: 0.000

Roughness Coefficient

(PMD = ROUND PIPE)

The Flow Roughness Coefficient used in the flow calculation formula.

Value	Range: -999.000 to 9999.000
	Default: 0.000

Notes:

- For each PMD excluding *Exponential Devices*, and *Other*, you must enter up to four dimensions.
- In the wizard, you will be prompted for each dimension required for the PMD selected, and the respective PMD dimension name will be displayed.

PMD selected	Wizard dimension name (parameter menu reference)
Rectangular Flume BS-3680	
	APPROACH WIDTH B (2.15.4.5. OCM Dimension 1)
	THROAT WIDTH B (2.15.4.6. OCM Dimension 2)
	HUMP HEIGHT P (2.15.4.7. OCM Dimension 3)
	THROAT LENGTH L (2.15.4.8. OCM Dimension 4)
Round Nose Horizontal Crest Weir BS-3680	
	CREST WIDTH B (2.15.4.5. OCM Dimension 1)
	CREST HEIGHT P (2.15.4.6. OCM Dimension 2)
	CREST LENGTH L (2.15.4.7. OCM Dimension 3)
Trapezoidal Flume BS-3680	
	APPROACH WIDTH B (2.15.4.5. OCM Dimension 1)
	THROAT WIDTH B (2.15.4.6. OCM Dimension 2)
	HUMP HEIGHT P (2.15.4.7. OCM Dimension 3)
	THROAT LENGTH L (2.15.4.8. OCM Dimension 4)
U-Flume BS-3680	
	APPROACH DIAMETER DA (2.15.4.5. OCM Dimension 1)
	THROAT DIAMETER D (2.15.4.6. OCM Dimension 2)
	HUMP HEIGHT P (2.15.4.7. OCM Dimension 3)
	THROAT LENGTH L (2.15.4.8. OCM Dimension 4)
Finite Crest Weir BS-3680	
	CREST WIDTH B (2.15.4.5. OCM Dimension 1)
	CREST HEIGHT P (2.15.4.6. OCM Dimension 2)
	CREST LENGTH L (2.15.4.7. OCM Dimension 3)
Thin Plate Rectangular Weir BS-3680	
	APPROACH WIDTH B (2.15.4.5. OCM Dimension 1)
	CREST WIDTH B (2.15.4.6. OCM Dimension 2)
	CREST HEIGHT P (2.15.4.7. OCM Dimension 3)
Rectangular Weir Contracted	
	CREST WIDTH B (2.15.4.5. OCM Dimension 1)
Round Pipe	
	PIPE INSIDE DIAMETER D (2.15.4.5. OCM Dimension 1)

PMD selected (cont'd)	Wizard dimension name (parameter menu reference)
Palmer Bowlus Flume	
	MAXIMUM FLUME WIDTH HMAX (2.15.4.5. OCM Dimension 1)
H-Flume	
	MAXIMUM LISTED HEAD HMAX (2.15.4.5. OCM Dimension 1)

Maximum Head

The maximum level value associated with the PMD.

Value	Range: 0.000 to 60.000
	Default: 60.000

Zero Head Offset

The difference (positive or negative) between Low Calibration Point and zero head (level at zero flow).

Value	Range: -60.000 to 60.000
	Default: 0.000

Flowrate Units

The volume units used to display total flow.

Options	L/S, L/MIN, CUFT/S, CUFT/D, GAL/MIN, GAL/D, IMPGAL/MIN, IMPGAL/D, CUM/H, CUM/D, USER DEFINED *
	Default: L/S

* If **USER DEFINED** option selected, the value must be set after completing the wizard. See 2.15.3.8. *User Defined Unit* on page 193.

Maximum Flow at 20 mA

The maximum flowrate.

Value	Range: -999 to 9999999
	Default: 100

Flowrate Decimal

The maximum number of decimal units to be displayed.

Options	NO DIGITS, 1 DIGIT, 2 DIGITS, 3 DIGITS
	Default: NO DIGITS

Low Flow Cutoff

Eliminates totalizer activity for head levels at or below the cutoff value.

Value	Range: 0.000 to 60.000
	Default: 0.000

End of QS Flow Wizard

For QS to be successful, all changes must be applied.

Options	BACK, CANCEL, FINISH (Display returns to 1.1.1 Quick Start menu when Quick Start is successfully completed or cancelled. If CANCEL is selected, no changes are written to the device.)
----------------	--

To transfer Quick Start values to the device and return to Program menu, press **DOWN arrow ▼ (Finish)**. Then press **LEFT arrow ◀** three times to return to Measurement mode.

Note: It is strongly recommended that an *Auto Zero Head* be performed after completion of the wizard to ensure best accuracy. See *2.15.2. Auto Zero Head* on page 190.

1.2. Pump Control

Use this wizard to configure pumps if they will be used in your application. Be sure to first complete the applicable Quick Start Wizard.

- Press **RIGHT arrow** ► to activate PROGRAM mode and open menu level 1: MAIN MENU.
- Press **RIGHT arrow** ► to navigate to menu item 1.1.
- Press **DOWN arrow** ▼ and **RIGHT arrow** ► to open Pump Control.
- At each step, press **DOWN arrow** ▼ to accept default values and move directly to the next item,
or **RIGHT arrow** ► to open Edit mode: the current selection is highlighted.
- Scroll to desired item and press **RIGHT arrow** ► to store the change, then press **DOWN arrow** ▼ to continue.
- At any time, you can press **UP arrow** ▲ to go back, or **LEFT arrow** ◀ to cancel the wizard.

Start of Wizard - Pump Control

Note: The introduction screen is displayed only on the device when using the local push buttons. This screen is not part of the Quick Start when using SIMATIC PDM.

Shows the type of Wizard to be executed.

Options	CANCEL, START
----------------	---------------

Number of Pumps

Select the number of pumps to be used with pump control.

Options	NONE, 2
	Default: NONE

If set to NONE, pump control is disabled.

Relay Pump 1

Selects the relay assigned to Pump 1.

Options	RELAY 2, RELAY 3
	Default: RELAY 2

Relay Pump 2

View only. Automatically sets the relay assigned to Pump 2 based on relay selected for Pump 1 in previous step.

Options	If Relay Pump 1 = RELAY 2, then Relay Pump 2 = RELAY 3
(view only)	If Relay Pump 1 = RELAY 3, then Relay Pump 2 = RELAY 2

Pump Control Mode

Sets the control algorithm used to trip the relay.

Options supported per model	LUT420 Level Controller: ALTERNATE DUTY ASSIST, ALTERNATE DUTY BACKUP
	LUT430 Pump and Flow Controller: ALTERNATE DUTY ASSIST, ALTERNATE DUTY BACKUP, SERVICE RATIO DUTY ASSIST, SERVICE RATIO DUTY BACKUP, FIXED DUTY ASSIST, FIXED DUTY BACKUP
	LUT440 High Accuracy OCM: ALTERNATE DUTY ASSIST, ALTERNATE DUTY BACKUP, SERVICE RATIO DUTY ASSIST, SERVICE RATIO DUTY BACKUP, FIXED DUTY ASSIST, FIXED DUTY BACKUP
	Default (all models): ALTERNATE DUTY ASSIST

See *Pump Control Mode 2.7.1.4* on page 151 for descriptions of each.

Service Ratio Pump 1

Selects pump usage based on the RUN time ratio rather than last used.

Value	Range: 0 to 255
	Default: 1

This parameter displays only if a Service Ratio algorithm is selected for **Pump Control Mode**.

Service Ratio Pump 2

Selects pump usage based on the RUN time ratio rather than last used.

Value	Range: 0 to 255
	Default: 1

This parameter displays only if a Service Ratio algorithm is selected for **Pump Control Mode**.

Run Time Relay 2

Set the amount of time that pump Relay 2 has run, defined in hours.

Value	Range: 0 to 999999
	Default: 0

Use the default value for new pumps, or set this value for existing pumps with accumulated run time. (This parameter displays only if a Service Ratio algorithm is selected for **Pump Control Mode**.)

Run Time Relay 3

Set the amount of time that pump Relay 3 has run, defined in hours.

Value	Range: 0 to 999999
	Default: 0

Use the default value for new pumps, or set this value for existing pumps with accumulated run time. (This parameter displays only if a Service Ratio algorithm is selected for **Pump Control Mode**.)

ON Setpoint Pump 1

The level at which Pump 1 turns ON, defined in 2.1.1. Units.

Value	Range: 0.000 to 99999.000
	Default: 0.000

ON Setpoint Pump 2

The level at which Pump 2 turns ON, defined in 2.1.1. Units.

Value	Range: 0.000 to 99999.000
	Default: 0.000

OFF Setpoint Pump 1

The level at which Pump 1 turns OFF, defined in 2.1.1. Units.

Value	Range: 0.000 to 99999.000
	Default: 0.000

OFF Setpoint Pump 2

The level at which Pump 2 turns OFF, defined in 2.1.1. Units.

Value	Range: 0.000 to 99999.000
	Default: 0.000

End of Wizard - Pump Control

For Wizard to be successful, all changes must be applied.

Options	BACK, CANCEL, FINISH (Display returns to Pump Control menu when Wizard is successfully completed or cancelled. If CANCEL is selected, no changes are written to the device.)
----------------	--

To transfer values to the device and return to Program menu, press **DOWN arrow ▼** (Finish). Then press **LEFT arrow ◀** two times to return to Measurement mode.

Requesting an Echo Profile

- In PROGRAM mode, navigate to: **Main Menu > Diagnostics (3.2.) > Echo Profile (3.2.1.)**.
- Press **RIGHT arrow** ► to request a profile.

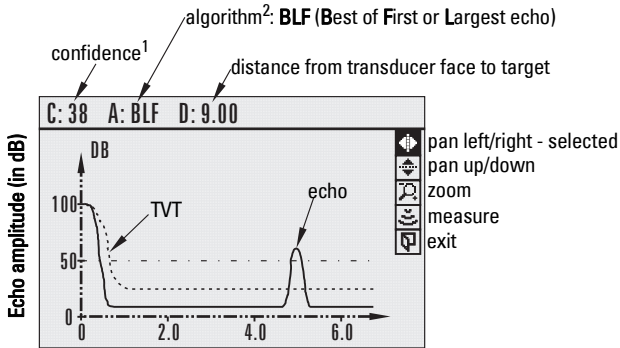

1. See Confidence (3.2.9.2.) on page 202.
2. See Algorithm (2.12.2.1.) on page 181.

- Use **UP** ▲ or **DOWN arrow** ▼ to scroll to an icon. When an icon is highlighted, that feature becomes active.
- To move a cross-hair, press **RIGHT arrow** ► to increase the value, **LEFT arrow** ◀ to decrease.
- To Zoom into an area, position the intersection of the cross-hairs at the center of that area, select **Zoom**, and press **RIGHT arrow** ►. Press **LEFT arrow** ◀ to Zoom out.
- To update the profile, select **Measure** and press **RIGHT arrow** ►.
- To return to the previous menu, select **Exit** then press **RIGHT arrow** ►.

Device Address

Setting a device address is not necessary for local operation, but must be set if configuring the SITRANS LUT400 for use on a HART network. See *Device Address 4.1* on page 215.

Testing the configuration

After programming the device, it is recommended that you test the device to ensure that it performs to your specifications. This test can be run in simulation mode or by varying the actual level in the application. The latter is preferred as it more accurately represents running conditions. However, if it is not possible to do a physical test, a simulation will ensure that control programming is correct. For further details, see *Simulation* on page 120, and *Application test* on page 123.

Application examples

In the examples that follow, substitute your own application details. If the examples do not apply to your application, check the applicable parameter reference for the available options.

Level Application Example

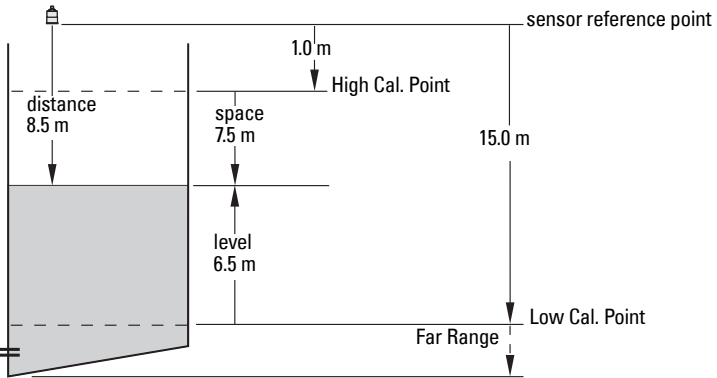

Quick Start Parameter	Setting	Description
Transducer	XPS-15	Transducer to be used with the LUT400.
Operation	LEVEL	Material level referenced from Low Cal. Point.
Temperature Source	TS-3	Temperature source.
Units	M	Sensor measurement units.
High Calibration Point	1.0	Process full level.
Low Calibration Point	15.0	Process empty level.
Response Rate	SLOW	Sets Fill Rate ^a / Empty Rate to 0.1 m/minute.

^a See *Fill Rate per Minute 2.3.1* on page 142.

The application is a vessel that takes an average 3 hours (180 minutes) to fill and 3 weeks to empty.

$$\begin{aligned} \text{Fill rate} &= (\text{Low Cal Pt.} - \text{High Cal Pt.}) / \text{fastest of fill or empty time} \\ &= (15.5 \text{ m} - 1 \text{ m}) / 180 \text{ min.} \\ &= 14.5 \text{ m} / 180 \text{ min.} = 0.08 \text{ m/min.} \end{aligned}$$

Flow application example

Parshall Flume

In this example, a 12 inch (0.305 m) Parshall Flume has been installed in an open channel. As per the supplier's data sheet, the device has been rated for a maximum flow of 1143 m³ per hour at a maximum head of 0.6 m.

The Parshall Flume is considered an exponential device, therefore the supplier's data sheet includes a flow exponent value of 1.522.

The SITRANS LUT400, and the XRS-5 transducer have been installed 1.6 m above the channel beside the TS-3 external temperature sensor.

During intermittent peak flow times, the head level can be expected to rise at a rate of approximately 0.12 m/minute. The application also calls for a flow sampler to be activated every 1000 m³, or 24 hours (whichever comes first), and for a fail-safe alarm to activate in the event of a loss of echo or cable fault.

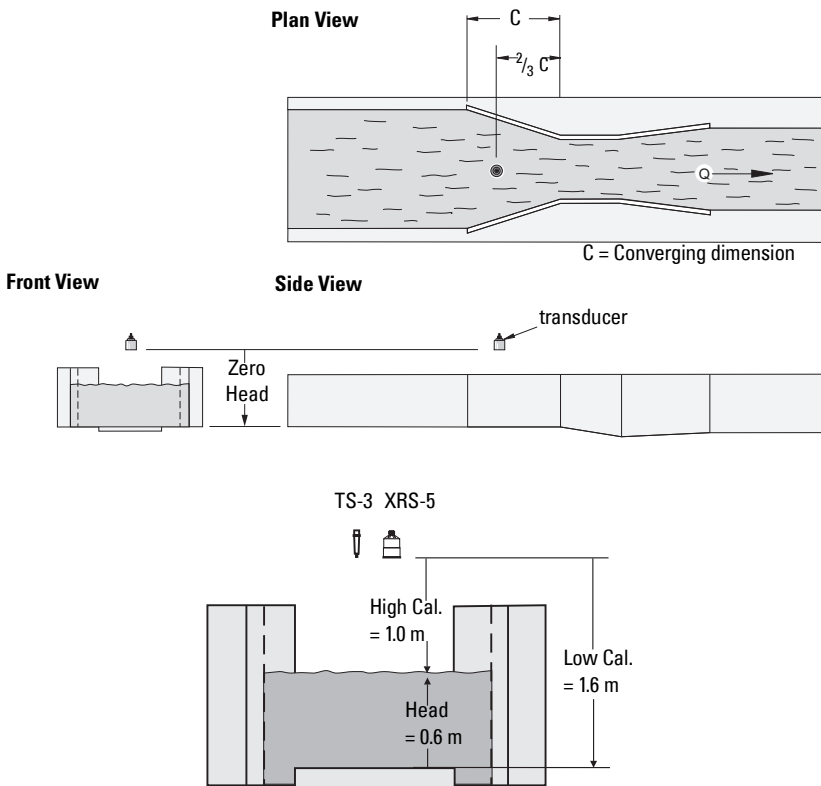

Initial device setup

Quick Start Parameter	Setting/ Value	Description
Transducer	XRS-5	For best accuracy, an XRS-5 transducer should be used in conjunction with the High Accuracy SITRANS LUT440.
Temperature Source	TS-3	For best accuracy, a TS-3 external temperature sensor is required.
Primary Measuring Device (PMD)	Exponential	Parshall Flumes are a type of exponential device.
Flow Exponent	1.522	Available from the PMD supplier data sheet.
Units	m	Units corresponding to the head measurement.
Low Calibration Point	1.6	The distance to the empty point or bottom of the flume. This sets the 4 mA setpoint.
High Calibration Point	1.0	The distance to the Max. Head. This sets the 20 mA setpoint.
Response Rate	Medium (1.0 m/min)	Response rate is set to be faster than the fastest rise in material level under typical operating conditions. In this example, the rate is faster than the Peak Time rate provided by the end user.
Method of Flow Calculation	Ratiometric	Used when the Max. Head and Max. Flow values are provided.
Maximum Head	0.6 m	Available from the PMD supplier data sheet.
Flowrate Units	Cum/hr	Set per end user requirements.
Maximum Flow at 20 mA	1143	Available from the PMD supplier data sheet.
Flowrate Decimal	No Digits	For the purpose of this example, decimals are not required.
Low Flow Cutoff	0.00	This parameter stops the LUT440 from totalizing if the head value corresponding to low flow is reached. This prevents flow from being totalized when the head level reaches the ineffective point of the PMD. Refer to the PMD data sheets for ratings.

Continue with alarm setup below.

Fail-safe Alarm setup

Parameter	Setting/ Value	Description
Enable (2.8.8.1)	Enabled	By selecting Enabled, the fail-safe alarm is now activated.
Assigned Relay (2.8.8.2)	Relay 1	Select relay to be used for fail-safe alarm. Relay 1 is the dedicated alarm relay for the LUT400.

Continue with sampler setup on next page.

External Sampler setup

Parameter	Setting/ Value	Description
Enable (2.11.4.1.)	Enabled	By selecting Enabled, the external sampler is now activated.
Multiplier (2.11.4.2.)	1000	In this example, the LUT440 will activate the external sampler every 1000 flow units (<i>Flowrate Units</i> defined above during initial application setup).
Interval (2.11.4.3.)	24	In low flow conditions where the sampler may not activate for extended periods of time, a relay interval can be programmed to allow for sampler activation after a defined number of hours. In this example, activation should occur every 24 hours.
Relay Duration (2.11.4.4.)	0.2	Duration of time in seconds that the relay will energize or "tick".
Assigned Relay (2.11.4.5.)	Relay 2	Relay 2 has been selected for control in this example as relay 1 has been allocated to the Fail-safe alarm.
Relay Logic (2.11.4.6.)	Normally Open	Default for control relay functions is Normally Open. In this example, relay 2's coil will be Normally Open, and will close for 0.2 seconds.

Notes

General Operation

This chapter provides details on the general operation and functionality of the SITRANS LUT400. For instructions on the use of the device LCD and local push buttons, refer to *The LCD Display* on page 34.

Starting measurement

The SITRANS LUT400 is a single point device. The device starts in LEVEL mode with a preset of no transducer and a low calibration point of 60 meters. Change the following common parameters to reflect your application.

Parameter	Sample Value
2.1.2. <i>Sensor Mode</i>	LEVEL
<i>Response Rate</i> (set via <i>QS Level</i> on page 39)	MEDIUM
2.1.6. <i>Transducer</i>	XPS-15
2.1.1. <i>Units</i>	M
2.2.1. <i>Low Calibration Point</i>	12
2.2.2. <i>High Calibration Point</i>	2

Measurement conditions

The following information will help you configure your SITRANS LUT400 for optimal performance and reliability.

Response Rate

The response rate of the device influences the measurement reliability. Use the slowest rate possible with the application requirements.

Note: Changes to fill and empty rate parameters can override Response Rate setting. See “Response Rate” on page 42.

Dimensions

Dimensions of the vessel, wet well, or reservoir (other than low and high calibration points) are only important if you require volume readings. In this case, all dimensions are used to calculate the volume value in terms of level. They are also used to calculate pumped volume.

Fail-safe

The fail-safe parameters ensure that the devices controlled by the SITRANS LUT400 default to an appropriate state when a valid level reading is not available. (See list of faults that result in fail-safe in *General Fault Codes* on page 231.)

- **2.4.2. LOE Timer** activates if an error condition is detected. Upon expiration of the timer, the mA output value and the relay status default to values based on **2.4.1. Material Level**.
- The fail-safe **2.4.1. Material Level** determines the mA output if the **2.4.2. LOE Timer** expires and the device is still in an error condition.

If fail-safe operation activates frequently, see *Diagnosing and Troubleshooting* on page 229.

Relays

Relays are the primary controls of external devices such as pumps or alarms. The SITRANS LUT400 comes with extensive control and alarm functions described below.

General introduction

Three relays are provided on the SITRANS LUT400. Each relay may be independently assigned to one function (one or more functions for alarms), and has a corresponding status icon on the LCD.

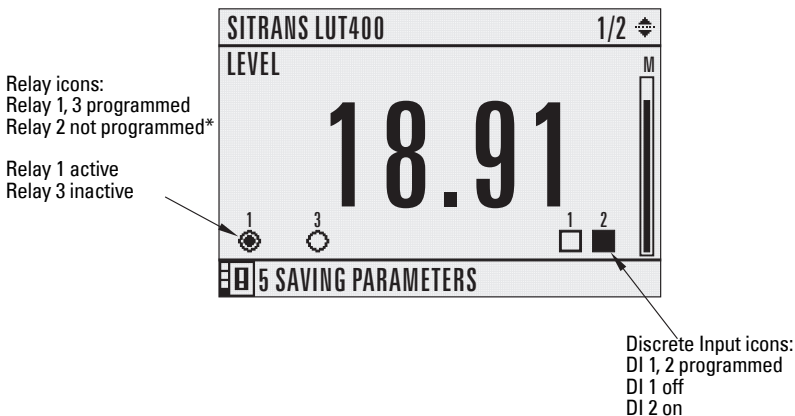

*Icon will not display for relay or DI that is not programmed.

Mode	Function (in normal state)
alarm	alarm ON = LCD icon ON = relay coil de-energized
pump	pump ON = LCD icon ON = relay coil energized
miscellaneous	contact closed = LCD icon ON = relay coil energized

Relay contact operation is **NORMALLY CLOSED** for alarms and **NORMALLY OPEN** for controls.

Options	Default	Alarm Contact	Pump or Control Contact
	*	Normally Closed	Normally Open
		Normally Open	Normally Closed

In software, all relays are programmed the same way, with ON setpoints indicating when to change the relay contact state (open or closed). Some parameters allow the reversal of the operation so that relay contacts can be **NORMALLY CLOSED** or **NORMALLY OPEN** (for example, when assigned to an alarm).

Relay function

Alarm

Level

In high alarm, the alarm state becomes active when the level rises to High Level Value ON and inactive when it falls below High Level Value OFF. In low alarm, the alarm state becomes active when the level falls to Low Level Value ON and inactive when the level rises above Low Level Value OFF.

In-bounds

The relay alarm becomes active if the level is inside a user-defined range.

Out-of-bounds

The relay alarm becomes active if the level is outside a user-defined range.

Temperature

In high alarm, the alarm state becomes active when the temperature rises to High Temperature Value ON and inactive when the temperature falls below High Temperature Value OFF. In low alarm, the alarm state becomes active when the temperature falls to Low Temperature Value ON and inactive when the temperature rises above Low Temperature Value OFF.

Switch (Discrete Input)

The relay alarm state associated with the discrete input becomes active when the discrete input is in a user-defined state.

Fail-safe fault

The relay alarm state becomes active when a fault that has caused a fail-safe condition is present. The relay alarm state becomes inactive when no faults that cause fail-safe are present.

Flowrate

Available for LUT440 (OCM) model only.

In high alarm, the alarm state becomes active when the flowrate exceeds High Flowrate Value ON and inactive when the flowrate falls below High Flowrate Value OFF. In low alarm, the alarm state becomes active when the flowrate falls below Low Flowrate Value ON and inactive when the flowrate rises above Low Flowrate Value OFF.

Pump

Setpoint - ON / OFF

If the ON setpoint is higher than the OFF setpoint, the relay operates as:

- pump down control

If the ON setpoint is lower than the OFF setpoint, the relay operates as:

- pump up control

Miscellaneous

Totalizer and samplers

Refer to *Other Pump Controls* on page 87. Relays are normally de-energized, contact closure is approximately 200 ms duration.

Relay behaviour under fail-safe conditions

A fail-safe condition generally indicates that the level reading is not reliable or is unknown. In such a situation, pumps will not run and alarms (that are based on level or a derivative reading) will not activate. The following describes this behaviour in detail, by relay function.

Alarm relays

Any alarm that is based on level, or a reading derived from level such as flow rate, will not activate if there is a fail-safe condition. If the fail-safe condition occurs and the alarm is already active, the alarm will de-activate.

The following alarm types will de-activate during a fail-safe condition:

- *High Level*
- *Low Level*
- *In-bounds Level*
- *Out-of-bounds Level*
- *High Flow Rate*
- *Low Flow Rate.*

Note: A dedicated alarm exists for fail-safe condition as described above. See *Fail-safe fault* on page 65.

Pump relays

If a pump cycle is in progress at the time the fail-safe condition occurs, then the pump cycle will end prematurely (as if the 'off' setpoints were reached). This has the effect of turning off all pumps immediately. If a pump run-on occurrence was scheduled for the pump cycle, *it will not occur*. However, if a pump run-on occurrence has already begun at the time the fail-safe condition occurs, then the run-on will complete.

If no pump cycle is in progress at the time the fail-safe condition occurs, then subsequent pump cycles will not occur (the fail-safe condition will prevent pumps from starting), until the fail-safe condition is cleared.

Miscellaneous relays

External Totalizer relay

If the external totalizer is in the process of recording volume (i.e. the relay is clicking) when a fail-safe condition occurs, then the current series of clicks will be allowed to complete.

When totalizing volume:

Since pumps do not run when in fail-safe, then the external totalizer will in general not operate either. If a fail-safe condition occurs during a pump cycle then the volume pumped for that cycle will *not* be totalized.

When totalizing OCM flow:

The flow totalizers continue to operate during a fail-safe condition, thus the external totalizer relay will also continue to operate.

External Sampler relay

The External Sampler relay operates the same as the External Totalizer relay described above. The periodic timeout-click will also continue to occur in fail-safe.

Communications relays

Relays controlled by communications (HART) are not affected by a fail-safe condition.

Relay states

The relays on the SITRANS LUT400 are programmable, allowing for many control schemes.

Relay Types
Relay 1 – NO / NC (Form C)
Relay 2,3 – NO (Form A)

Relay output logic

Affects relay reaction. Reverses the logic (normally-open to normally-closed or vice versa). Relay logic can be modified separately for alarms, and controls. (Logic for pumps cannot be reversed.)

Function	Parameter
<i>2.8.11. Relay Logic for 2.8. Alarms</i>	<i>2.8.11.1. Relay 1 Logic</i> <i>2.8.11.2. Relay 2 Logic</i> <i>2.8.11.3. Relay 3 Logic</i>
<i>2.11. Other Control</i>	<i>2.11.1. Elapsed Time Relay</i> <i>2.11.1.5. Relay Logic</i>
	<i>2.11.2. Time of Day Relay</i> <i>2.11.2.5. Relay Logic</i>
	<i>2.11.3. External Totalizer</i> <i>2.11.3.5. Relay Logic</i>
	<i>2.11.4. External Sampler</i> <i>2.11.4.6. Relay Logic</i>

Relay related parameters

Some parameters affect how relays react during normal conditions:

Setpoints

When a setpoint is reached, the corresponding action is taken. The setpoint can be an ON or OFF setpoint related to a process variable, or a timed setpoint based on interval and duration.

1. ON and OFF Setpoints

Sets the process point at which the relay is activated (ON setpoint) then reset (OFF setpoint). These setpoints are set separately for each pump within each pump control, and for each alarm type:

Function		Parameter
2.7. Pumps	2.7.1. Basic Setup	2.7.1.6. ON Setpoint Pump 1
		2.7.1.7. OFF Setpoint Pump 1
		2.7.1.8. ON Setpoint Pump 2
		2.7.1.9. OFF Setpoint Pump 2
2.7.2. Modifiers (for 2.7. Pumps)	2.7.2.2. Energy Savings	2.7.2.2.13. Peak ON Setpoint Pump 1
		2.7.2.2.14. Peak OFF Setpoint Pump 1
		2.7.2.2.15. Peak ON Setpoint Pump 2
		2.7.2.2.16. Peak OFF Setpoint Pump 2
2.8. Alarms	2.8.1. High Level Alarm	2.8.1.2. High Level Value ON
		2.8.1.3. High Level Value OFF
	2.8.2. Low Level Alarm	2.8.2.2. Low Level Value ON
		2.8.2.3. Low Level Value OFF
	2.8.4. In-bounds Level Alarm	2.8.4.2. High Level Value
		2.8.4.3. Low Level Value
	2.8.5. Out-of-bounds Level Alarm	2.8.5.2. High Level Value
		2.8.5.3. Low Level Value
	2.8.6. Low Temperature Alarm	2.8.6.2. Low Temperature Value ON
		2.8.6.3. Low Temperature Value OFF
2.8.7. High Temperature Alarm	2.8.7.2. High Temperature Value ON	
	2.8.7.3. High Temperature Value OFF	
2.8.9. High Flowrate Alarm	2.8.9.2. High Flowrate Value ON	
	2.8.9.3. High Flowrate Value OFF	
2.8.10. Low Flowrate Alarm	2.8.10.2. Low Flowrate Value ON	
	2.8.10.3. Low Flowrate Value OFF	

2. Timed Setpoints

Timed setpoints are based on interval, duration, or time of day. These setpoints are set separately for each pump within each pump control, and for each non-pump control function:

Function		Parameter
2.7.2. Modifiers (for 2.7. Pumps)	2.7.2.3. Pump Run-On	2.7.2.3.2. Run-On Interval
		2.7.2.3.3. Run-On Duration Pump 1
		2.7.2.3.4. Run-On Duration Pump 2
2.11. Other Control	2.7.2.4. Pump Start Delays	2.7.2.4.1. Delay Between Starts
		2.7.2.4.2. Power Resumption Delay
	2.11.1. Elapsed Time Relay	2.11.1.2. Interval
		2.11.1.3. Relay Duration
	2.11.2. Time of Day Relay	2.11.2.2. Activation Time
		2.11.2.3. Relay Duration
	2.11.3. External Totalizer	2.11.3.3. Relay Duration
	2.11.4. External Sampler	2.11.4.3. Interval
2.11.4.4. Relay Duration		

Relays controlled by HART Communications

A relay can be controlled directly by a remote system through communications. HART commands can be used for this purpose. An expert knowledge of HART, and the use of HART commands is recommended. For further details on configuring relays controlled by HART, contact your Siemens representative.

Discrete Inputs

SITRANS LUT400 has two discrete inputs to trigger or alter the way SITRANS LUT400 controls devices. A Backup Level Override, Pump Interlock, or a Switch (DI) Alarm can be configured using discrete inputs, and discrete input logic can be reversed if necessary for the application.

Backup Level Override

Backup level override provides the option of overriding the ultrasonic input (signal from a transducer) with another contacting point level device, such as the Pointek CLS200, to determine the level output.

The material reading is fixed at the programmed switch level until the discrete input is released. The LUT400 makes its decisions based on the override value.

Note: A backup level override will prevent a fail-safe condition from occurring.

Backup Level Override functionality is particularly useful in wet-wells and reservoirs that use pumps:

- place a backup level switch high in a vessel to indicate when it is about to overflow
- place a backup level switch low in a vessel, to indicate when it is almost empty.

Basic operation

Configuring Backup Level Override involves three steps (see *2.9.1. Backup Level Override*).

1. Select a level override value. This will be the Level output produced by the instrument when the backup level override condition is present.
2. Select the discrete input that is connected to the point-level device.
3. Enable the Backup Level Override function.

It may also be necessary to invert the logic of the discrete input, which is possible through the LUT400 discrete input logic parameters (see *2.9.2. Discrete Input Logic*).

Backup Level Override parameters

Example:

SITRANS LUT400 is configured for a level measurement. In the same application, Discrete Input 2 is connected to a Hi Level Backup switch at a level value of 4.3 m.

Settings

Parameter	Sample Value
2.9.1.2. <i>Level Override Value</i>	4.3
2.9.1.3. <i>Discrete Input Number</i>	DISCRETE INPUT 2
2.9.1.1. <i>Enable</i>	ENABLED

When the level rises to 4.3 m and the switch is activated, the reading is forced to 4.3 m where it stays until the switch is de-activated.

Level Override conditions

When the discrete input activates, the level output will immediately take on the value chosen in step 1 above. The LUT400 LCD will indicate that the discrete input has been activated.

When a Backup Level Override condition clears (the discrete input is deactivated), the level will return to the value determined from the ultrasonic transducer or, if no echo is available, the device will enter the fail-safe condition.

Affect of Backup Level Override

The level produced by a Backup Level Override condition completely replaces the level that would otherwise be produced by normal echo processing algorithms. This means that the Backup Level will:

- drive all readings that depend on Level (for example: space, distance, and flow)
- drive level alarms
- appear in system logs
- affect pump control
- affect totalizers (OCM and Pumped Volume)

Additional considerations

A Backup Level Override condition will prevent a fail-safe condition from occurring: when a backup level override condition is present, a fail-safe response will never occur. This allows pumps and other controls such as level alarms to be active even during the backup level override condition.

Pump Interlocks

Discrete inputs can be used to supply pump information to the SITRANS LUT400 to set actions that will occur when a pump is determined to be in a failed state.

For an example of how to configure a pump interlock, see *Pump Control Interlocks* on page 87.

Switch (DI) Alarm

An alarm can be set to activate based on the state of a discrete input. See *Switch (DI) Alarm* on page 70 for an example.

Discrete Input Logic

Discrete input logic affects the reaction of the discrete input. Normal state is standard operation, with the SITRANS LUT400 sensing the material level and controlling the pumps.

The contacts of the signalling device connected to the discrete inputs may be **normally-open** or **normally closed**.

Example:

Normal state for a backup high level switch is **open**, and the contacts on the discrete input are wired as **normally open**.

This logic can also be reversed (NORMALLY OPEN to NORMALLY CLOSED or vice versa). Use the Discrete Input logic parameters to set the state of each discrete input.

Function	Parameter	
2.9. Discrete Inputs	2.9.2. Discrete Input Logic	2.9.2.1. Discrete Input 1 Logic
		2.9.2.3. Discrete Input 2 Logic

Read the current state of discrete input 1 in *2.9.2.2. Discrete Input 1 Scaled State* and the current state of discrete input 2 in *2.9.2.4. Discrete Input 2 Scaled State*.

See *Discrete inputs* on page 28 for complete details on wiring the discrete inputs. To override a level using a discrete input, see *2.9.1. Backup Level Override* on page 171.

mA Control

mA output

The SITRANS LUT400 has one mA output, used for communications with other devices.

Example:

Configuring the mA output to send a 4 to 20 mA signal corresponding to a scaled value of 10% to 90% of maximum process level on a 60 m transducer:

Parameter	Sample Value	Description
<i>2.5.1. Current Output Function or 2.5.2. Current Output Function</i>	LEVEL	send mA proportional to level reading
<i>2.5.3. 4 mA Setpoint</i>	6	set 4 mA at process level equal to 10% of maximum (Low Cal minus High Cal) ^a
<i>2.5.4. 20 mA Setpoint</i>	54	set 20 mA at process level equal to 90% of maximum (Low Cal minus High Cal) ^b
<i>2.5.5. Minimum mA Limit</i>	3.5	set minimum mA level below 4 mA
<i>2.5.6. Maximum mA Limit</i>	22.8	set maximum mA level above 20 mA

a. If the level reading drops below 6 m, the mA output drops below 4 mA.

b. If the level reading rises above 54 m, the mA output rises above 20 mA.

Note: If default values (4 and 20 mA) are used for the minimum and maximum mA limits, the mA output (shown in *2.5.8. Current Output Value*) will remain at the set mA limit, even if the level reading falls below/rises above the mA setpoints.

Verifying the mA range

Checks that the external device can track the entire 4 to 20 mA range sent by the SITRANS LUT400. Follow the steps below if actual mA readings differ between the LUT400 (shown in *2.5.8. Current Output Value*) and an external device (such as a PLC).

1. To test the loop current, set *2.5.1. Current Output Function* to **Manual**, then set the value to use in *2.5.7. Manual Value*.
2. Check that the external device displays the same mA reading as the mA value set above.
3. If external device reading differs from the set manual value on the LUT400, adjust the reading on the external device to match the reading on the LUT400.

Volume

Volume is used in two situations:

1. Calculate and display volume instead of level.
2. Calculate pumped volume to accomplish the following:
 - Totalize the volume of material that is pumped out of the wet well

Readings

When using volume, readings are given in units specified in *2.6.2. Volume Units*.

Vessel Shape and Dimensions

There are many common vessel shapes to select from. (See *2.6.1. Vessel Shape*. If possible, use one of these.) Each vessel shape uses the *2.2.1. Low Calibration Point* in its calculations of volume.

Some vessel shapes also require extra dimensions to calculate the volume. Do not estimate these values. They must be correct to ensure the accuracy of your volume calculations.

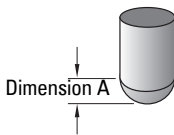

Example:

To configure volume for a vessel with a half-sphere bottom, set the following:

Parameter	Sample Value	Description
<i>2.6.1. Vessel Shape</i>	HALF SPHERE BOTTOM	selects the correct vessel shape
<i>2.6.3. Maximum Volume</i>	100	sets maximum volume at 100 (defined in <i>2.6.2. Volume Units</i>)
<i>2.6.4. Dimension A</i>	1.3	sets dimension A to 1.3 m

Notes:

- The default reading changes to a range from 0 to 100
- The process empty value is still measured to the bottom of the vessel (*2.2.1. Low Calibration Point* plus any *2.2.5. Far Range* value), not the top of **Dimension A**.

Characterization chart

If you cannot use a pre-defined vessel, then use one of the universal vessel shapes and program the characterization curve.

1. Plot a volume to height chart. Usually a vessel supplier will provide this chart. However, if you have a custom-built vessel, then you will need access to complete drawings of the well or accurate measurements.

2. Enter the curve values from this chart into level and volume breakpoint tables (see 2.6.7. Table 1-8).

Note: If breakpoints are entered via LUI, then an upload is performed via PDM, a second upload via PDM may be necessary to transfer the breakpoint values.

3. Ensure extra points are added around sharp transitions in the vessel volume (e.g. steps in a well wall).

Note: The end points in the curve are 0,0 (fixed) and the point defined by Maximum Level and Maximum Volume.

Example chart (with 15 of possible 32 Level and Volume breakpoints defined):

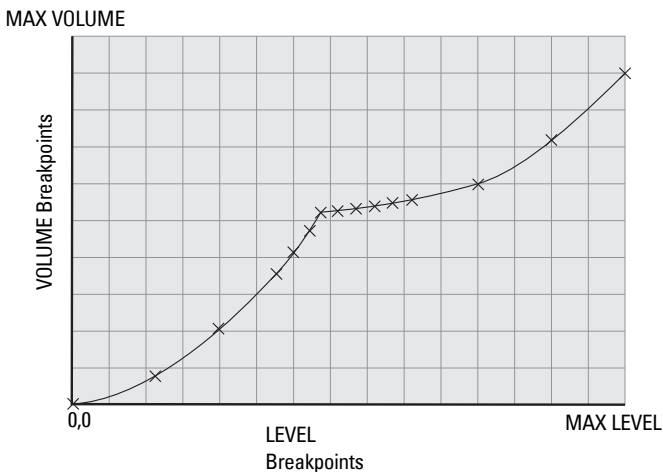

Parameter	Value	Description
2.6.7.1. Level 1	0.0	Determines the Level breakpoints at which the volumes are known.
Level 2	0.8	
Level 3	2.0	
Level 4	3.5	
Level 5	4.1	
Level 6	4.7	
Level 7	5.1	
Level 8	5.2	
Level 9	5.3	
Level 10	5.4	
Level 11	5.5	
Level 12	5.6	
Level 13	6.0	
Level 14	7.2	
Level 15	9.0	

Parameter	Value	Description
<i>2.6.7.2. Volume 1</i>	0.0	<p>Determines the volumes which correspond to the level breakpoints. The universal calculations interpret between the breakpoints to produce an accurate model of the volume at all level readings.</p> <p>Settings</p> <p><i>2.6.1. Vessel Shape</i> = LINEAR TABLE for linear approximation</p> <p><i>2.6.1. Vessel Shape</i> = CURVE TABLE for curved approximation</p> <p>Linear approximation uses a linear algorithm; curved approximation uses a cubic spline algorithm.</p>
Volume 2	2.1	
Volume 3	4.0	
Volume 4	5.6	
Volume 5	5.9	
Volume 6	6.3	
Volume 7	6.7	
Volume 8	7.1	
Volume 9	7.8	
Volume 10	8.2	
Volume 11	8.8	
Volume 12	9.2	
Volume 13	10.9	
Volume 14	13.0	
Volume 15	15.0	

Alarms

Set the common parameters

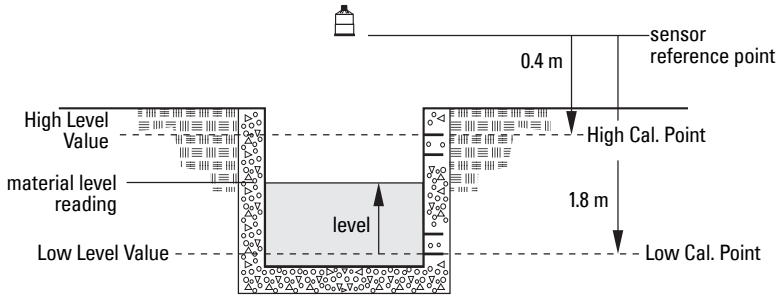

Prerequisite: You must know the details of your application and substitute the values for the sample values provided. If you are bench testing the device, then set your test values to be the same as the sample values.

Parameter	Sample Value
2.1.2. <i>Sensor Mode</i> (for Level)	LEVEL
or	FLOW
2.1.3. <i>Sensor Mode</i> (for Flow)	
<i>Response Rate</i>	MEDIUM
2.1.6. <i>Transducer</i>	XPS-10
2.1.1. <i>Units</i> (for Level Alarms)	M
2.15.3.7. <i>Flowrate Units</i> (for Flowrate Alarms)	L/S
2.2.1. <i>Low Calibration Point</i>	1.8
2.2.2. <i>High Calibration Point</i>	0.4

Note: When configuring alarms, more than one alarm can be assigned to the same relay.

Level

The level alarm is the most common. Use this alarm to warn you when your process is in danger of being upset due to high or low levels.

High level and low level alarms can be set to activate when the material level rises above or falls below a set level. (See 2.8.1. *High Level Alarm*, 2.8.2. *Low Level Alarm*.)

Example: Setting a High Level Alarm

To assign Relay 3 to a high level alarm that activates when the level rises above 10 m:

1. Enable the High Level Alarm (set 2.8.1.1. *Enable* = **Enabled**)
2. Set 2.8.1.2. *High Level Value ON* = **10 m**

3. Set 2.8.1.3. *High Level Value OFF* = 9 m
4. Set 2.8.1.4. *Assigned Relay* to **Relay 3**

Use the High Level alarm in conjunction with 2.8.12. *Time To Spill* feature. See page 170.

Example: Setting a Low Level Alarm

To assign Relay 3 to a low level alarm that activates when the level falls below 2 m:

1. Enable the Low Level Alarm (set 2.8.2.1. *Enable* = **Enabled**)
2. Set 2.8.2.2. *Low Level Value ON* = 2
3. Set 2.8.2.3. *Low Level Value OFF* = 3
4. Set 2.8.2.4. *Assigned Relay* to **Relay 3**

In-bounds/ Out-of-bounds Range

Use the bounded range alarms to detect when the level is inside or outside of the range.

Example: Setting an In-bounds Level Alarm

To assign Relay 3 to an in-bounds level alarm do the following:

1. Enable the In-bounds Level Alarm (set 2.8.4.1. *Enable* = **Enabled**)
2. Set 2.8.4.2. *High Level Value* = 1.30 m
3. Set 2.8.4.3. *Low Level Value* = 0.30 m
4. Set 2.8.4.4. *Assigned Relay* to **Relay 3**.

Results:

- Activates alarm assigned to relay 3 when level is within range 0.3 to 1.3 m
- Resets alarm above 1.3 m or below 0.3 m

Use 2.8.4.5. *Alarm State* to view the current state of the In-bounds Level Alarm.

Example: Setting an Out-of-bounds Level Alarm

To assign Relay 3 to an out-of-bounds level alarm do the following:

1. Enable the Out-of-bounds Level Alarm (set 2.8.5.1. *Enable* = **Enabled**)
2. Set 2.8.5.2. *High Level Value* = 1.30 m
3. Set 2.8.5.3. *Low Level Value* = 0.30 m
4. Set 2.8.5.4. *Assigned Relay* to **Relay 3**.

Results:

- Activates alarm assigned to relay 3 when level is outside range 0.3 to 1.3 m
- Resets alarm below 1.30 m or above 0.30 m

Use 2.8.5.5. *Alarm State* to view the current state of the Out-of-bounds Level Alarm.

Temperature

Activates an alarm when the process temperature reaches a certain value (Low Temperature Value ON for Low Temperature Alarm or High Temperature Value ON for a High Temperature Alarm).

The temperature source can be the temperature sensor built into the transducer or an external TS-3, as set by *Temperature Source*. (Temperature Source is set in the Quick Start Wizard, see page 39.)

Example: Setting a High Temperature Alarm

To assign Relay 3 to a high temperature alarm that activates when the temperature goes above 30 °C do the following:

1. Enable the High Temperature Alarm (set *2.8.7.1. Enable* = **Enabled**)
2. Set *2.8.7.2. High Temperature Value ON* = **30**
3. Set *2.8.7.3. High Temperature Value OFF* = **28**
4. Set *2.8.7.4. Assigned Relay* to **Relay 3**.

The high temperature alarm will not de-activate until the temperature falls to 28 °C. Use *2.8.7.5. Alarm State* to view the current state of the High Temperature Alarm.

Example: Setting a Low Temperature Alarm

To assign Relay 3 to a low level alarm that activates when the temperature falls below -10 °C do the following:

1. Enable the Low Level Alarm (set *2.8.6.1. Enable* = **Enabled**)
2. Set *2.8.6.2. Low Temperature Value ON* = **-10**
3. Set *2.8.6.3. Low Temperature Value OFF* = **- 8**
4. Set *2.8.6.4. Assigned Relay* to **Relay 3**.

Use *2.8.6.5. Alarm State* to view the current state of the Low Temperature Alarm.

Switch (Discrete Input) Alarm

Activates an alarm when a discrete input is in a pre-defined state.

Example: Setting a Switch Alarm

To assign Relay 3 to a switch alarm that is activated when DI 1 turns ON do the following:

1. Enable the Switch (Discrete Input) Alarm (set *2.8.3.1. Enable* = **Enabled**)
2. Set the *2.8.3.2. Discrete Input Number* = **1**
3. Set *2.8.3.3. Discrete Input State* to **ON**.
4. Set *2.8.3.4. Assigned Relay* to **Relay 3**.

Use *2.8.3.5. Alarm State* to view the current state of the Switch Alarm.

Fail-safe Fault Alarm

Activates an alarm when a fault that has caused a fail-safe condition is present.

Example: Setting a Fail-safe Fault Alarm

To assign a fail-safe fault alarm to Relay 3 do the following:

1. Enable the Fail-safe Fault Alarm (set 2.8.8.1. *Enable* = **Enabled**)
2. Set 2.8.8.2. *Assigned Relay* to **Relay 3**.

Use 2.8.8.3. *Alarm State* to view the current state of the Fail-safe Alarm.

Flowrate

Flowrate alarms are available on LUT440 (OCM) model only. They can activate an alarm if the OCM flowrate is above or below a given setpoint.

Example: Setting a High Flowrate Alarm

To assign Relay 3 to a high flowrate alarm that activates when the flowrate rises above 10 l/s:

1. Enable the High Flowrate Alarm (set 2.8.9.1. *Enable* = **Enabled**).
2. Set 2.8.9.2. *High Flowrate Value ON* = **10**
3. Set 2.8.9.3. *High Flowrate Value OFF* = **8**
4. Set 2.8.9.4. *Assigned Relay* to **Relay 3**

Example: Setting a Low Flowrate Alarm

To assign Relay 3 to a low level alarm that activates when the flowrate falls below 2 l/s:

1. Enable the Low Flowrate Alarm (set 2.8.10.1. *Enable* = **Enabled**)
2. Set 2.8.10.2. *Low Flowrate Value ON* = **2**
3. Set 2.8.10.3. *Low Flowrate Value OFF* = **4**
4. Set 2.8.10.4. *Assigned Relay* to **Relay 3**

Pump Control

The SITRANS LUT400 has the pump control functionality to solve nearly any water / wastewater application.

To set up pump control for simple applications, see *Pump Control Wizard* in LUT400 Communications manual¹.

¹ Communications for SITRANS LUT400 (HART) Manual (7ML19985NE01)

Pump Control options

Methods of pump control are dependent on two variables:

Pump start method indicates in what sequence pumps are started; using Fixed, Alternate, or Service Ratio setpoints.

Pump duty indicates whether new pumps start and run with any currently running pumps (most common) or whether new pumps start and shut off currently running pumps; using Assist or Backup duty.

Pump Control algorithms

Algorithms are used to provide six modes of pump control. They can be used to start multiple pumps (assist) or one pump at a time (backup). These six modes can be grouped into three main methods of pump control used by the SITRANS LUT400: Fixed, Alternate, and Service Ratio. The LUT420 (Level) model operates with Alternate pump control only.

Fixed: Starts pumps based on individual setpoints and always starts the same pumps in the same sequence [Fixed Duty Assist (FDA), and Fixed Duty Backup (FDB)].

Alternate: Starts pumps based on the duty schedule and always leads with a new pump [Alternate Duty Assist (ADA), and Alternate Duty Backup (ADB)].

Service Ratio: Starts pumps based on user-defined ratio of running time [Service Ratio Duty Assist (SRA), and Service Ratio Duty Backup (SRB)].

Alternate Duty Assist (ADA) is set as the default.

Setting a pump down (wet well) group

Setting a group of two pumps to pump down a wet well.

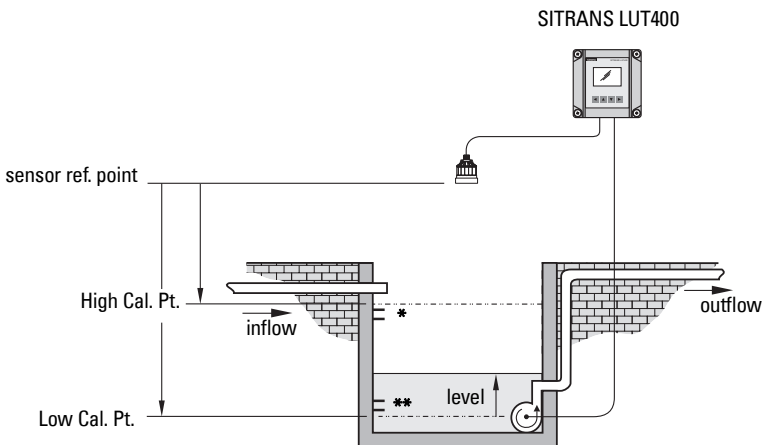

Setpoint sample values: * ON Setpoint Pump 1 / Pump 2
(see tables below) ** OFF Setpoint Pump 1 / Pump 2

Set the common parameters

Prerequisite: Substitute the details of your application in place of the sample values provided. If you are bench testing the device, set your test values to be the same as the sample values.

Parameter	Sample Value
2.1.2. Sensor Mode	Level
Response Rate	Medium
2.1.6. Transducer	XPS-10
2.1.1. Units	M
2.2.1. Low Calibration Point	1.8
2.2.2. High Calibration Point	0.4

Set Relays to ALTERNATE DUTY ASSIST (ADA)

Parameter	Value	Description
2.7.1.4. Pump Control Mode	ADA	Sets the control algorithm used to trip the pump relay to ALTERNATE DUTY ASSIST . Multiple pumps can run simultaneously.
2.7.1.5. Pump Control Mode		

Set the ON Setpoints

Parameter	Sample Value ^a	Description
2.7.1.6. ON Setpoint Pump 1	1.0 m *	Sets the level at which pump 1 turns on. The first cycle will use this setpoint. Subsequent cycles rotate the setpoint among the pumps. For example: In cycle 1, pump 1 turns on at 1 m. In the next cycle, pump 2 will turn on at 1 m.
2.7.1.8. ON Setpoint Pump 2	1.1 m *	Sets the level at which pump 2 turns on.

^a. Sample values denoted by asterisks in illustration on page 80.

Set the OFF Setpoints

Parameter	Sample Value ^a	Description
2.7.1.7. OFF Setpoint Pump 1	0.5 m **	Sets the level at which pump 1 turns off. The first cycle will use this setpoint. Subsequent cycles rotate the setpoint among the pumps. For example: In cycle 1, pump 1 turns off at 0.5 m. In the next cycle, pump 2 will turn off at 0.5 m.
2.7.1.9. OFF Setpoint Pump 2	0.6 m **	Sets the level at which pump 2 turns off.

^a. Sample values denoted by asterisks in illustration on page 80.

Other Pump Control algorithms

Set Relays to ALTERNATE DUTY BACKUP (ADB)

Parameter	Value	Description
2.71.4. Pump Control Mode or 2.71.5. Pump Control Mode	ADB	Sets the control algorithm used to trip the pump relay to ALTERNATE DUTY BACKUP . Only one pump can run at a time.

Set the ON Setpoints

Parameter	Sample Value	Description
2.71.6. ON Setpoint Pump 1	1.3 m	Sets the level at which pump 1 turns on. The first cycle will use this setpoint. Subsequent cycles rotate the setpoint among the pumps.
2.71.8. ON Setpoint Pump 2	1.2 m	Sets the level at which pump 2 turns on.

Set the OFF Setpoints

Parameter	Sample Value	Description
2.71.7. OFF Setpoint Pump 1	0.4 m	Sets the level at which pump 1 turns off. The first cycle will use this setpoint. Subsequent cycles rotate the setpoint among the pumps.
2.71.9. OFF Setpoint Pump 2	0.3 m	Sets the level at which pump 2 turns off.

Set Relays to FIXED DUTY ASSIST (FDA)

Parameter	Value	Description
2.71.5. Pump Control Mode	FDA	Sets the control algorithm used to trip the pump relay to FIXED DUTY ASSIST . Multiple pumps can run simultaneously.

Set the ON Setpoints

Parameter	Sample Value	Description
2.71.6. ON Setpoint Pump 1	1.3 m	Sets the level at which pump 1 turns on.
2.71.8. ON Setpoint Pump 2	1.2 m	Sets the level at which pump 2 turns on.

Set the OFF Setpoints

Parameter	Sample Value	Description
2.71.7. OFF Setpoint Pump 1	0.4 m	Sets the level at which pump 1 turns off.
2.71.9. OFF Setpoint Pump 2	0.3 m	Sets the level at which pump 2 turns off.

Set Relays to FIXED DUTY BACKUP (FDB)

Parameter	Value	Description
2.71.5. Pump Control Mode	FDB	Sets the control algorithm used to trip the pump relay to FIXED DUTY BACKUP . Only one pump can run at a time.

Set the ON Setpoints

Parameter	Sample Value	Description
2.71.6. ON Setpoint Pump 1	1.3 m	Sets the level at which pump 1 turns on.
2.71.8. ON Setpoint Pump 2	1.2 m	Sets the level at which pump 2 turns on.

Set the OFF Setpoints

Parameter	Sample Value	Description
2.71.7. OFF Setpoint Pump 1	0.4 m	Sets the level at which pump 1 turns off.
2.71.9. OFF Setpoint Pump 2	0.3 m	Sets the level at which pump 2 turns off.

Set Relays to SERVICE RATIO DUTY ASSIST (SRA)

Parameter	Value	Description
2.71.5. Pump Control Mode	SRA	Sets the control algorithm used to trip the pump relay to SERVICE RATIO DUTY ASSIST . Multiple pumps can run simultaneously. Pump usage is based on RUN time rather than last used.
2.71.10. Service Ratio Pump 1	25	Sets the ratio to: 25% for pump 1, i.e. pump 1 will run 25% of the time.
2.71.11. Service Ratio Pump 2	75	Sets the ratio to: 75% for pump 2, i.e. pump 2 will run 75% of the time

Set the ON Setpoints

Parameter	Sample Value	Description
2.71.6. ON Setpoint Pump 1	1.3 m	Sets the level at which the first pump turns on.
2.71.8. ON Setpoint Pump 2	1.2 m	Sets the level at which the second pump turns on.

Set the OFF Setpoints

Parameter	Sample Value	Description
2.71.7. OFF Setpoint Pump 1	0.4 m	Sets the level at which the first pump turns off.
2.71.9. OFF Setpoint Pump 2	0.3 m	Sets the level at which the second pump turns off.

Set Relays to SERVICE RATIO DUTY BACKUP (SRB)

Parameter	Value	Description
2.71.5. Pump Control Mode	SRB	Sets the control algorithm used to trip the pump relay to SERVICE RATIO DUTY BACKUP . Only one pump can run at a time. Pump usage is based on RUN time rather than last used.

Set the Service Ratio for each pump

Parameter	Sample Value	Description
2.71.10. Service Ratio Pump 1	25	Sets the ratio to: 25% for pump 1, i.e. pump 1 will run 25% of the time.
2.71.11. Service Ratio Pump 2	75	Sets the ratio to: 75% for pump 2, i.e. pump 2 will run 75% of the time

Set the ON Setpoints

Parameter	Sample Value	Description
2.71.6. ON Setpoint Pump 1	1.3 m	Sets the level at which the first pump turns on.
2.71.8. ON Setpoint Pump 2	1.2 m	Sets the level at which the second pump turns on.

Set the OFF Setpoints

Parameter	Sample Value	Description
2.71.7. OFF Setpoint Pump 1	0.4 m	Sets the level at which the first pump turns off.
2.71.9. OFF Setpoint Pump 2	0.3 m	Sets the level at which the second pump turns off.

Notes:

- The SITRANS LUT400 will not sacrifice other pumping strategies to ensure that the service ratio is held true
- If the pump ratios are set to the same value, then the ratio equals 1:1 and all pumps are used equally (default)

When a pump start is required (ON Setpoint), the pump with the fewest running hours (with respect to the assigned ratio values) starts.

Conversely, when a pump stop is required (OFF Setpoint), if multiple pumps are running simultaneously, the pump with the most running hours (as compared to the assigned ratio values) stops.

Setting a pump up (reservoir) group

Sets a group of two pumps to pump up a reservoir.

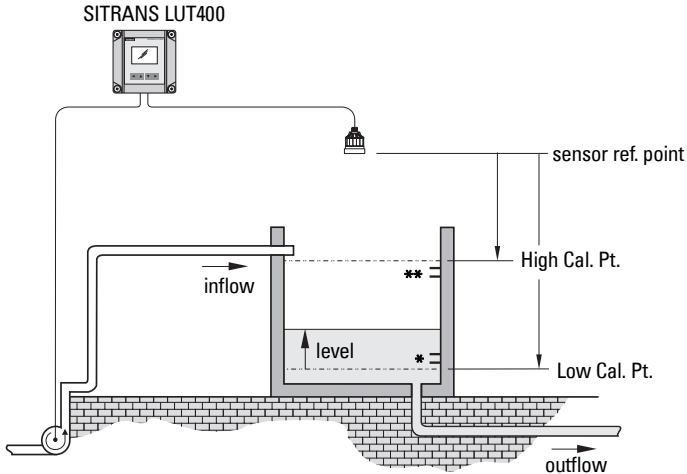

Setpoint sample values: * ON Setpoint Pump 1 / Pump 2
 (see tables below) ** OFF Setpoint Pump 1 / Pump 2

Set the common parameters

Prerequisite: Substitute the details of your application in place of the sample values provided. If you are bench testing the device, set your test values to be the same as the sample values.

Parameter	Sample Value
2.1.2. Sensor Mode or 2.1.3. Sensor Mode	Level
Response Rate	Medium
2.1.6. Transducer	XPS-10
2.1.1. Units	M
2.2.1. Low Calibration Point	1.8
2.2.2. High Calibration Point	0.4

Set Relays to ALTERNATE DUTY ASSIST (ADA)

Parameter	Value	Description
2.7.1.4. Pump Control Mode or 2.7.1.5. Pump Control Mode	ADA	Sets the control algorithm used to trip the pump relay to ALTERNATE DUTY ASSIST .

Set the ON Setpoints

Parameter	Sample Value ^a	Description
<i>2.71.6. ON Setpoint Pump 1</i>	0.4 m*	Sets the level at which pump 1 turns on. The first cycle will use this setpoint. Subsequent cycles rotate the setpoint among the pumps. For example: In cycle 1, pump 1 turns on at 0.4 m. In the next cycle, pump 2 will turn on at 0.4 m.
<i>2.71.8. ON Setpoint Pump 2</i>	0.3 m*	Sets the level at which pump 2 turns on.

^a. Sample values denoted by asterisks in illustration on page 85.

Set the OFF Setpoints

Parameter	Sample Value ^a	Description
<i>2.71.7. OFF Setpoint Pump 1</i>	1.3 m**	Sets the level at which pump 1 turns off. The first cycle will use this setpoint. Subsequent cycles rotate the setpoint among the pumps. For example: In cycle 1, pump 1 turns off at 1.3 m. In the next cycle, pump 2 will turn off at 1.3 m.
<i>2.71.9. OFF Setpoint Pump 2</i>	1.2 m**	Sets the level at which pump 2 turns off.

^a. Sample values denoted by asterisks in illustration on page 85.

Pump Control Interlocks

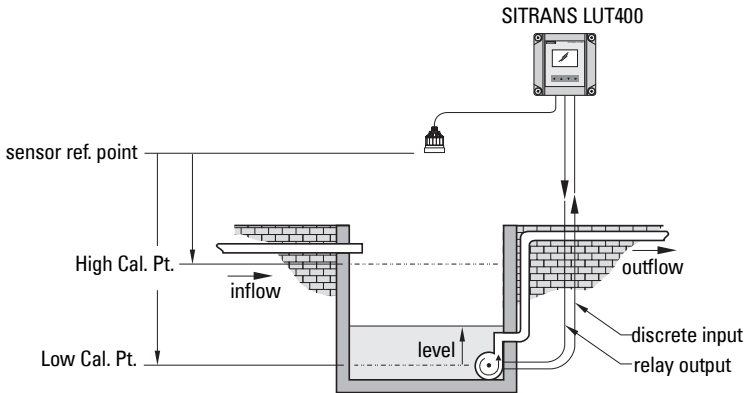

Parameter	Sample Value	Description
2.71.4. Pump Control Mode or 2.71.5. Pump Control Mode	ADA	Sets the control algorithm used to trip the pump relay to ALTERNATE DUTY ASSIST.
2.9.3.1. Enable Pump 1	ON	Enables pump start interlock for Pump 1.
2.9.3.2. Pump 1 Discrete Input	Discrete Input 1	Sets the discrete input to use for pump start interlock on Pump 1.
2.9.3.3. Enable Pump 2	ON	Enables pump start interlock for Pump 2.
2.9.3.4. Pump 2 Discrete Input	Discrete Input 2	Sets the discrete input to use for pump start interlock on Pump 2.
2.9.2.1. Discrete Input 1 Logic	Normally Closed	Use if necessary to reverse logic for Discrete Input 1.
2.9.2.3. Discrete Input 2 Logic	Normally Closed	Use if necessary to reverse logic for Discrete Input 2.

These values will ensure that any pump reporting a failure is removed from the pumping rotation. For more information on pump interlocks and discrete inputs, see *Discrete Inputs* on page 69.

Other Pump Controls

Prerequisite: Common parameters must first be set for each pump control below:

Parameter	Sample Value
2.1.2. Sensor Mode or 2.1.3. Sensor Mode	Volume
Response Rate	Medium
2.1.6. Transducer	XPS-10
2.1.1. Units	M
2.2.1. Low Calibration Point	1.8
2.2.2. High Calibration Point	0.4

Totalizing pumped volume

Available only on LUT430 (Pump and Flow model), and LUT440 (OCM model).

Prerequisite: The volume of the vessel must be known.

Parameter	Sample Value	Description
2.6.1. Vessel Shape	LINEAR	Vessel shape is linear (flat bottom)
2.6.3. Maximum Volume	17.6	Max volume is 17.6m ³ or 17,600 liters.
2.7.1.4. Pump Control Mode or 2.7.1.5. Pump Control Mode	ADA	Sets the control algorithm used to trip the pump relay to ALTERNATE DUTY ASSIST .
2.7.1.6. ON Setpoint Pump 1	1.0 m	Sets the level at which pump 1 turns on. The first cycle will use this setpoint. Subsequent cycles rotate the setpoint among the pumps.
2.7.1.8. ON Setpoint Pump 2	1.2 m	Sets the level at which pump 2 turns on.
2.7.1.7. OFF Setpoint Pump 1	0.2 m	Sets the level at which pump 1 turns off. The first cycle will use this setpoint. Subsequent cycles rotate the setpoint among the pumps.
2.7.1.9. OFF Setpoint Pump 2	0.3 m	Sets the level at which pump 2 turns off.
2.7.3.2. Totalizer Decimal Position	2 DIGITS	Sets the totalizer display to 2 digits.
2.7.3.3. Totalizer Multiplier	1000	Actual volume is divided by 1000, prior to display on LCD.
2.7.3.4. Inflow/Discharge Adjust	RATE ESTIMATE	The inflow rate measured just prior to the start of the pump cycle is used to estimate the inflow for the duration of the cycle.

1. Display vessel volume on the LCD (set parameter 2.1.2. *Sensor Mode* to **VOLUME**).
2. Toggle to SV on LCD to display current level (set parameter 2.1.4. *Sensor Mode Secondary* to **LEVEL**).
3. See 2.7.3.1. *Running Totalizer* to view pumped volume.

Setting a pump to run-on

This functionality is used to reduce sludge and sediment from building up at the bottom of a wet well, thereby reducing maintenance. This is achieved by running the pumps below the normal OFF setpoint and requires you to set a run-on duration and interval to control this event.

Example:

Pump 1 is set to pump for an extra 60 seconds every 5 hours, pump 2 should not run-on.

Parameter	Sample Value	Description
<i>2.72.3.2. Run-On Interval</i>	5	Five hours between pump run-on occurrences.
<i>2.72.3.3. Run-On Duration</i>	60	The pump will run-on for 60 seconds.
<i>Pump 1</i>		
<i>2.72.3.4. Run-On Duration</i>	0	Pump 2 will never run-on.
<i>Pump 2</i>		

Setting the pump start delays

In the event that power to the SITRANS LUT400 has been lost, the pump start delay ensures that all of the pumps do not start at once to avoid power surges. There are two parameters used here: Pump Start Delay and Power Resumption Delay.

Example:

The delay between pumps is set to 20 seconds and the delay of the first pump is set to 30 seconds.

Parameter	Sample Value	Description
<i>2.72.4.1. Delay Between Starts</i>	20	Wait at least 20 seconds between pump starts.
<i>2.72.4.2. Power Resumption Delay</i>	60	Wait for 60 seconds when power is restored for the first pump to activate.

Reducing wall cling

Use the Wall Cling Reduction function to randomly alter the ON and OFF setpoints over a range. This eliminates the ridge of material that builds up at the setpoint that can give false echoes.

This setting may increase the number of days between trips to clean the wet well.

Enable Wall Cling Reduction by setting 2.7.2.1.1. *Enable* = **Enabled**. Then set the range in 2.7.2.1.2. *Level Setpoint Variation*. The pump ON and OFF setpoints are randomly varied inside this range so the material level does not stop at the same point each time.

Example:

A range of 0.5 meters is used to vary the setpoint. The randomly-selected setpoints are always **inside** the ON and OFF setpoints.

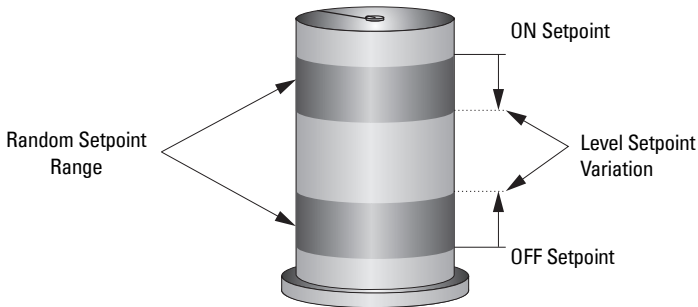

Saving energy

Pumps can use different setpoints at different times of the day to account for variable energy costs.

The following example illustrates high energy cost usage reduction and/or elimination by using the SITRANS LUT400 Energy Savings function on a wet well (pump down application) using pump 1.

Pre-requisite: enable Energy Savings function (set 2.7.2.2.1. *Enable* = **Enabled**)

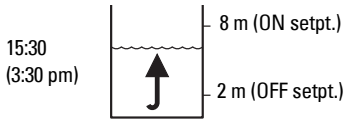

Normal Operation

Uses the standard ON and OFF setpoints (2.7.1.6. *ON Setpoint Pump 1* | 2.7.1.7. *OFF Setpoint Pump 1*). Energy cost is at minimum.

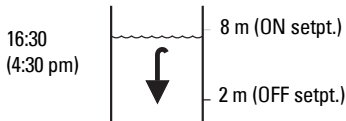

2.7.2.2.2. Peak Lead Time = 60 minutes.

Pumps down the wet well regardless of the pump ON Setpoints. This ensures that the wet well starts the high cost period at the 2.7.1.7. *OFF Setpoint Pump 1*. Energy cost is at minimum.

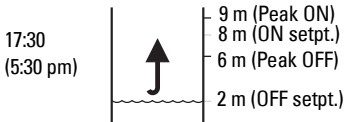

2.7.2.2.3. Peak 1 Start Time = 17:30.

Starts using the energy savings setpoints (2.7.2.2.13. *Peak ON Setpoint Pump 1* and 2.7.2.2.14. *Peak OFF Setpoint Pump 1*). Energy cost is at maximum.

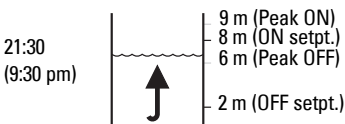

2.7.2.2.4. Peak 1 End Time = 21:30.

Returns to normal setpoints (2.7.1.6. *ON Setpoint Pump 1* | 2.7.1.7. *OFF Setpoint Pump 1*). Energy cost returns to minimum.

Generally, you would cascade the timing of the pump downs so that the wells farthest from the treatment facility would begin first and the entire system would push material through during the low cost period.

Note: When the Peak ON Setpoint is not reached, no energy is used during the **high cost** period. If the Peak ON Setpoint is reached, the Wet Well is only pumped down to 6 m, thereby minimizing **high cost** energy usage.

Parameter	Value	Description
2.7.2.2.1. <i>Enable</i>	Enabled	Enables Energy Savings function
2.7.2.2.3. <i>Peak 1 Start Time</i>	17:30	Starts the first high cost period at 5:30 pm
2.7.2.2.4. <i>Peak 1 End Time</i>	21:30	Ends the first high cost period at 9:30 pm
2.7.2.2.2. <i>Peak Lead Time</i>	00:60	Sets the pump down to happen 60 minutes before the high cost period
2.7.2.2.13. <i>Peak ON Setpoint Pump 1</i>	9	Sets the high cost ON setpoint at process level of 9 m
2.7.2.2.14. <i>Peak OFF Setpoint Pump 1</i>	6	Sets the high cost OFF setpoint at process level of 6 m

Tracking pump usage

You can find out how much an individual pump has been used by viewing the pump record parameters.

Information Available	Parameter Access
Total running hours for a relay assigned to a pump.	3.2.7.1. <i>Run Time Relay 2</i> 3.2.7.2. <i>Run Time Relay 3</i>

Other controls

Relays controlled by time

A relay can be controlled by time setpoints using Time of Day or Elapsed Time.

Set Time of Day Relay

Parameter	Value	Description
2.11.2.1. <i>Enable</i>	Enabled	Enables Time of Day Relay
2.11.2.2. <i>Activation Time</i>	17:30	Activates the relay at 5:30 pm
2.11.2.3. <i>Relay Duration</i>	60	Activates the relay for 60 seconds
2.11.2.4. <i>Assigned Relay</i>	Relay 1	Sets relay 1 to be controlled by time of day
2.11.2.5. <i>Relay Logic</i>	Normally Closed	Use (if necessary) to change the behaviour of the relay assigned to the time of day control. Default: Normally Open

Set Elapsed Time Relay

Parameter	Value	Description
2.11.1.1. <i>Enable</i>	Enabled	Enables elapsed time relay
2.11.1.2. <i>Interval</i>	24	Activates the relay every 24 hours
2.11.1.3. <i>Relay Duration</i>	60	Activates the relay for 60 seconds
2.11.1.4. <i>Assigned Relay</i>	Relay 1	Sets relay 1 to be controlled by elapsed time
2.11.1.5. <i>Relay Logic</i>	Normally Closed	Use (if necessary) to change the behaviour of the relay assigned to the elapsed time control. Default: Normally Open

Flow

Flow calculation

The SITRANS LUT400 provides numerous open channel flow calculation features (see 2.15. *Flow*).

The device can be configured to select the flow calculation specific to the primary measuring device (PMD), such as a flume or weir. If the PMD does not match any of the eleven preset PMD calculations, a universal flow calculation can be used (PMD = Universal Head Flow). See *Flow Calculation* on page 265 for more details.

The SITRANS LUT400 converts the head measurement into flow rate. The flow rate is totalized and stored in a comprehensive data log to facilitate detailed flow analysis.

Totalizing flow

Totalizing of the calculated flow is ongoing. Daily and running totalizers can be viewed in 2.16. *Totalizers*. The daily totalizer resets automatically every 24 hours at 23:59:59, and both can be reset by the user.

In order to adjust the rate of filling of the totalizer, the 2.7.3.3. *Totalizer Multiplier* can be set to an appropriate value. Totalizing that is specific to a time and date can be viewed under View Logs for flow (see 3.2.6.2. *OCM* on page 201).

The SITRANS LUT400 can be programmed to operate a remote totalizer by assigning any of the relays to act as a totalizer contact. Under this function, the maximum rate of contact closure is 5/s with a closure duration of 100 ms.¹

External Totalizers and Flow Samplers

External totalizers are simple counters which count the number of relay clicks produced by the SITRANS LUT400. This is generally used to keep track of OCM or pumped volume totals. Note that both of these values are also stored in the SITRANS LUT400 and are available through communications.

Flow samplers are devices which take a sample of liquid when triggered by a relay click. These samples are used to monitor water quality over time. Flow samplers can be driven by OCM volume, pumped volume, or by time depending on the application requirements.

¹ Typically the totalizer should be set for 300 to 3000 counts per day at maximum flow.

Relay contacts

Pumped volume is calculated at the end of the pump cycle. Totalized volume when *External Totalizer* function is enabled will be given in bursts at the end of the pump cycle, not throughout the pump cycle.

Use 2.11.3.3. *Relay Duration* to set the time in seconds from one change of state in the relay to the next. This parameter sets both the open and closed times for the relay contact and is preset to 0.2 seconds. Partial units are added to the next pump cycle.

Example:

Shows a relay set up to make one contact for every cubic metre (m^3) of liquid.

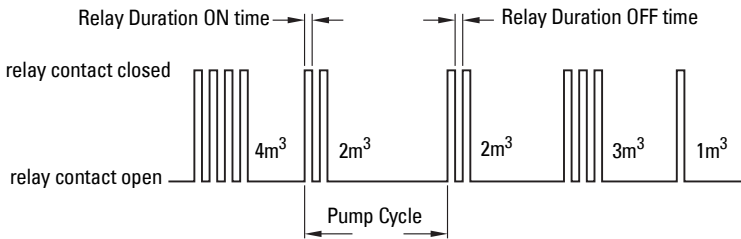

The following parameters describe how to setup a Totalizer or Sampler.

Totalizer

Use the *2.11.3. External Totalizer* function to set the totalizer to provide relay contact to an external counter.

Counter Formula	
1 contact every x units, where $x =$ value set in <i>2.11.3.2. Multiplier</i>	<i>2.11.3.2. Multiplier</i> is preset to 1 so the default number of contacts is one contact per unit of volume.
Example: To click once every 4310 units, set <i>2.11.3.2. Multiplier</i> to 4310.	

The totalizer source, and units depend on the volume configuration:

Volume Configuration	Totalizer Source	Units Source
<i>2.6.1. Vessel Shape</i> = NONE	<i>2.16. Totalizers</i> (OCM flow totalizer)	<i>2.15.3.7. Flowrate Units</i>
<i>2.6.1. Vessel Shape</i> = any setting other than NONE	<i>2.7.3. Totalizers</i> (pumped volume totalizer)	<i>2.6.2. Volume Units</i>

Parameter	Sample Value	Description
<i>2.11.3.1. Enable</i>	Enabled	Enables External Totalizer Relay
<i>2.11.3.2. Multiplier</i>	4310	Click once every 4310 units
<i>2.11.3.3. Relay Duration</i>	0.2	Activates the relay for 0.2 seconds
<i>2.11.3.4. Assigned Relay</i>	Relay 1	Sets relay 1 to be controlled by external totalizer
<i>2.11.3.5. Relay Logic</i>	Normally Closed	Use (if necessary) to change the behaviour of the relay assigned to the totalizer. Default: Normally Open

Flow Sampler

Use the *2.11.4. External Sampler* function to activate the flow sampler relay based on volume and time.

Counter Formula

1 contact every x units, where x = value set in *2.11.4.2. Multiplier*

Example:

To click once every 4310 units, set *2.11.4.2. Multiplier* to 4310.

2.11.4.2. Multiplier is preset to **1** so the default number of contacts for a pumped volume cycle is one contact per unit of volume.

The totalizer source, and units depend on the volume configuration:

Volume Configuration	Totalizer Source	Units Source
<i>2.6.1. Vessel Shape</i> = NONE	<i>2.16. Totalizers</i> (OCM flow totalizer)	<i>2.15.3.7. Flowrate Units</i>
<i>2.6.1. Vessel Shape</i> = any setting other than NONE	<i>2.7.3. Totalizers</i> (pumped volume totalizer)	<i>2.6.2. Volume Units</i>

By using *2.11.4.2. Multiplier*, the relay contacts can be based on a volume other than a multiple of ten.

Parameter	Sample Value	Description
<i>2.11.4.1. Enable</i>	Enabled	Enables Flow Sampler Relay
<i>2.11.4.2. Multiplier</i>	4310	Click once every 4310 units
<i>2.11.4.3. Interval</i>	2	Sets the INTERVAL (in hours) of the relay contact, usually long.
<i>2.11.4.4. Relay Duration</i>	0.2	Sets the DURATION (in seconds) of the relay contact, usually short.
<i>2.11.4.5. Assigned Relay</i>	Relay 1	Sets relay 1 to be controlled by flow sampler
<i>2.11.4.6. Relay Logic</i>	Normally Closed	Use (if necessary) to change the behaviour of the relay assigned to the sampler. Default: Normally Open

During the periods of low flow, the sampler may be idle for lengths of time. Program *2.11.4.3. Interval* time in hours to drive the sampler. The sampler will operate based on the volume of flow or the time interval, whichever comes first.

Open Channel Monitoring (OCM)

An OCM installation is defined one of three ways, based on the Primary Measuring Device (PMD):

1. Dimensional

For some common weir and flume types. PMD dimensions (*2.15.4. PMD Dimensions*) are entered directly.

Vessel Type	See page:
<i>BS- 3680 Rectangular Flume</i>	105
<i>BS- 3680 Round Nose Horizontal Crest Weir</i>	106
<i>BS- 3680 Trapezoidal Flume</i>	107
<i>BS- 3680 U-Flume</i>	108
<i>BS- 3680 Finite Crest Weir</i>	109
<i>BS- 3680 Thin Plate Rectangular Weir</i>	110
<i>BS- 3680 Thin Plate V-Notch Weir</i>	111
<i>Rectangular Weir Contracted</i>	112
<i>Round Pipe</i>	113
<i>Palmer Bowlus Flume</i>	114
<i>H-Flume</i>	115

2. Exponential

For most other weir and flume types. PMD exponents provided by the manufacturer are entered. Flow is calculated using the exponent (*2.15.3.2. Flow Exponent*) and the maximum values (*2.15.3.3. Maximum Head* and *2.15.3.4. Maximum Flow at 20 mA*).

Vessel Type	See page:
<i>Standard Weirs</i>	116
<i>Parshall Flume</i>	101
<i>Leopold Lagco Flume</i>	102
<i>Cut Throat Flume</i>	103

3. Universal

For all other PMDs, the head-to-flow curve can be plotted based on known breakpoints, usually supplied by the PMD manufacturer.

Vessel Type	See page:
<i>Typical flow characterization</i>	116
<i>Example flumes</i>	117
<i>Example weirs</i>	118

Method of Flow Calculation

When using the SITRANS LUT400 in a flow application, the **Method of Flow Calculation (215.3.1.)** must be selected. There are two possible methods for calculating flow with the SITRANS LUT400: absolute or ratiometric, and different information must be entered for the device to carry out the calculation. For more details, and an example, see *Method of Flow Calculation* on page 266.

Common parameters

These common parameters are required for all installations.

Parameter	Sample Value
	Flow
<i>Response Rate</i>	MEDIUM
<i>2.1.6. Transducer</i>	XRS-5
<i>2.1.1. Units</i>	M
<i>2.2.1. Low Calibration Point</i>	1.8
<i>2.2.2. High Calibration Point</i>	0.4
<i>2.2.5. Far Range</i>	0.8

Setting Zero Head

Many PMDs start flowing higher than the traditional empty distance of the application. You can account for the flow in one of two ways:

1. Use *2.15.3.5. Zero Head Offset* to have OCM calculations ignore levels below that value. Possible head = *2.2.1. Low Calibration Point* minus *2.2.2. High Calibration Point*.

Note: *2.15.3.3. Maximum Head* is preset to *2.2.1. Low Calibration Point* minus *2.2.2. High Calibration Point* and is not updated when *2.15.3.5. Zero Head Offset* is used. Make sure you set *2.15.3.3. Maximum Head* to the correct value when using *2.15.3.5. Zero Head Offset*. (Refer to PMD supplier documentation for Maximum Head.)

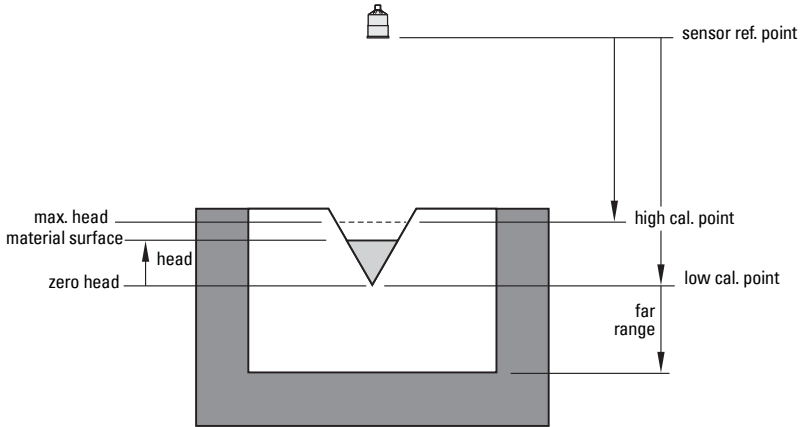

2. Use *2.2.5. Far Range* where the empty level is set to the bottom of the weir, and above the bottom of the channel. It should be used if the surface monitored can fall past the *2.2.1. Low Calibration Point* level in normal operation without reporting an LOE. The value is added to *2.2.1. Low Calibration Point* and can be greater than the range of the transducer.

The examples on the following pages show both methods.

PMDs with Exponential Flow to Head function

For Primary Measuring Devices (PMDs) that measure flow by an exponential equation, use these parameters. Ensure that you use the correct exponent for your PMD; the values below are samples only.

Standard Weirs

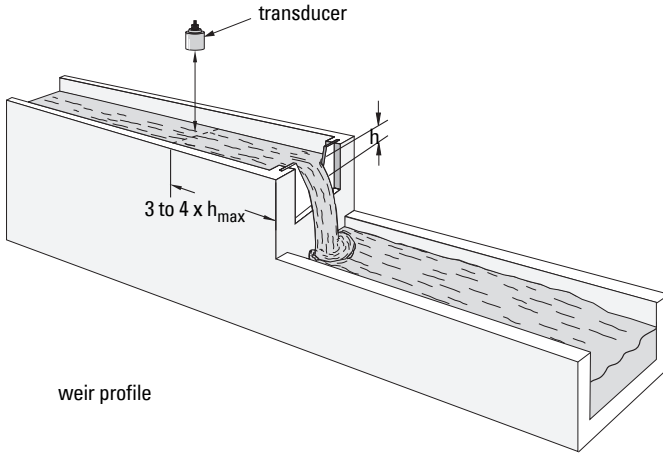

weir profile

Applicable weir profiles

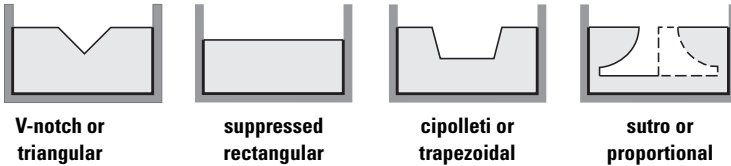

V-notch or triangular

suppressed rectangular

cippolletti or trapezoidal

sutro or proportional

Parameter	Value										
2.15.1. Primary Measuring Device (PMD)	Exponential Devices										
2.15.3.2. Flow Exponent	<table border="1"> <thead> <tr> <th>Weir Type</th> <th>Value^a</th> </tr> </thead> <tbody> <tr> <td>V-notch</td> <td>2.50</td> </tr> <tr> <td>Suppressed rectangular</td> <td>1.50</td> </tr> <tr> <td>Cipolletti or trapezoidal</td> <td>1.50</td> </tr> <tr> <td>Sutro or proportional</td> <td>1.00</td> </tr> </tbody> </table>	Weir Type	Value ^a	V-notch	2.50	Suppressed rectangular	1.50	Cipolletti or trapezoidal	1.50	Sutro or proportional	1.00
Weir Type	Value ^a										
V-notch	2.50										
Suppressed rectangular	1.50										
Cipolletti or trapezoidal	1.50										
Sutro or proportional	1.00										
2.15.3.3. Maximum Head											
2.15.3.4. Maximum Flow at 20 mA											
2.15.3.7. Flowrate Units											
2.2.5. Far Range											
2.15.4.1. K Factor ^b											

- a. Values are samples only. Consult weir manufacturer's documentation for correct flow exponent.
- b. Required for exponential device absolute calculation only.

Parshall Flume

Note: C = Converging Dimension.

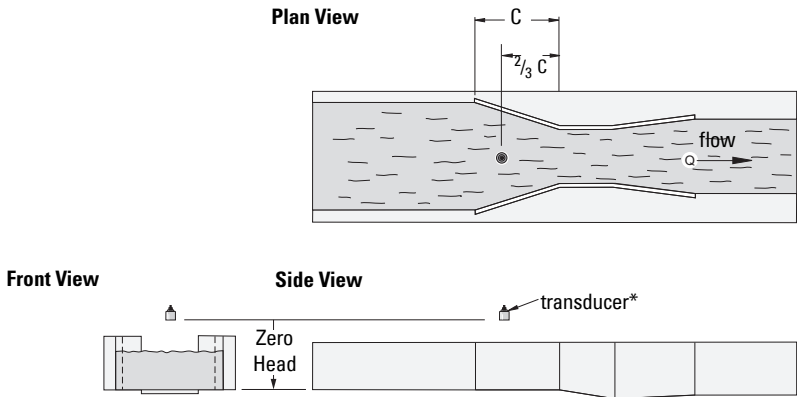

* The transducer must be above the maximum head by at least the blanking value (see 2.2.4. *Near Range*).

Application information

- Sized by throat width
- Set on solid foundation
- For rated flows under free flow conditions, the head is measured at $\frac{2}{3}$ the length of the converging section from the beginning of the throat section

Parameter	Value
2.15.1. <i>Primary Measuring Device (PMD)</i>	Exponential Devices
2.15.3.2. <i>Flow Exponent</i>	1.522–1.607 ^a
2.15.3.3. <i>Maximum Head</i>	
2.15.3.4. <i>Maximum Flow at 20 mA</i>	
2.15.4.1. <i>K Factor</i> ^b	

- Typical Flow Exponent range for Parshall Flume; consult your flume documentation.
- Required for exponential device absolute calculation only.

Leopold Lagco Flume

Plan View

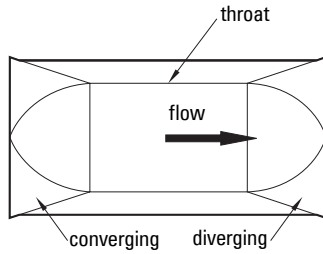

Side View

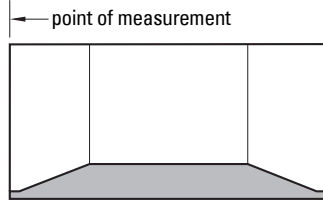

Front View

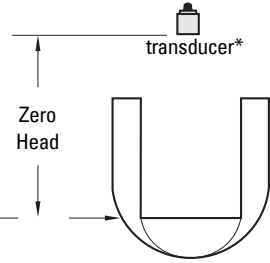

* The transducer must be above the maximum head by at least the blanking value (see 2.2.4. *Near Range*).

Parameter	Value
2.15.1. Primary Measuring Device (PMD)	Exponential Devices
2.15.3.2. Flow Exponent	1.547 ^a
2.15.3.3. Maximum Head	
2.15.3.4. Maximum Flow at 20 mA	
2.15.3.5. Zero Head Offset	
2.15.3.7. Flowrate Units	
2.15.4.1. K Factor ^b	

- a. Typical Flow Exponent for Leopold Lagco Flume; consult your flume documentation.
- b. Required for exponential device absolute calculation only.

Application information

- Designed to be installed directly into pipelines and manholes
- Leopold Lagco may be classed as a rectangular Palmer-Bowlus flume
- Sized by pipe (sewer) diameter
- For rated flows under free flow conditions, the head is measured at a point upstream referenced to the beginning of the converging section. Refer to the following table:

Flume Size (pipe diameter in inches)	Point of Measurement	
	cm	inches
4-12	2.5	1
15	3.2	1.25
18	4.4	1.75
21	5.1	2

Flume Size (pipe diameter in inches)	Point of Measurement	
	cm	inches
24	6.4	2.5
30	7.6	3
42	8.9	3.5
48	10.2	4
54	11.4	4.5
60	12.7	5
66	14.0	5.5
72	15.2	6

Cut Throat Flume

Plan View

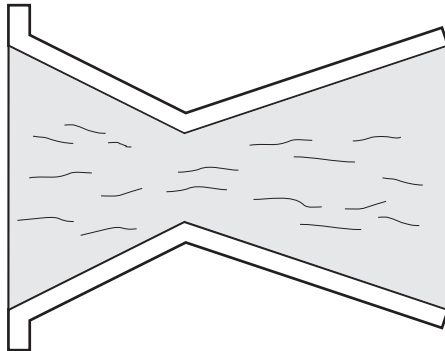

Application information

- Similar to Parshall flume except that the floor is flat bottomed and throat has no virtual length.
- Refer to manufacturer's specifications for flow equation and point of head measurement.

Parameter	Value
2.15.1. Primary Measuring Device (PMD)	Exponential Devices
2.15.3.2. Flow Exponent	1.56 - 2.00 ^a
2.15.3.3. Maximum Head	
2.15.3.4. Maximum Flow at 20 mA	
2.15.3.7. Flowrate Units	
2.15.4.1. K Factor ^b	

- Typical Flow Exponent range for Cut Throat Flume; consult your flume documentation.
- Required for exponential device absolute calculation only.

Khafagi Venturi

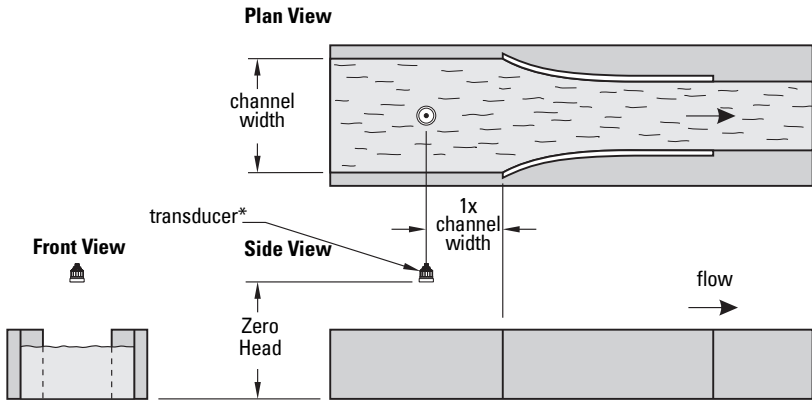

* The transducer must be above the maximum head by at least the blanking value (see 2.2.4. *Near Range*).

Application information

- Similar to Parshall flume except that the floor is flat bottomed and the sidewalls are curved.
- For rated flows under free flow conditions, the head is measured 1 x (channel width) upstream from the beginning of the converging section.

Parameter	Value
2.15.1. Primary Measuring Device (PMD)	Exponential Devices
2.15.3.2. Flow Exponent	1.55 (Consult your flume documentation.)
2.15.3.3. Maximum Head	
2.15.3.4. Maximum Flow at 20 mA	
2.15.3.7. Flowrate Units	
2.15.4.1. K Factor ^a	

- a. Required for exponential device absolute calculation only.

Applications supported by SITRANS LUT400

BS- 3680 Rectangular Flume

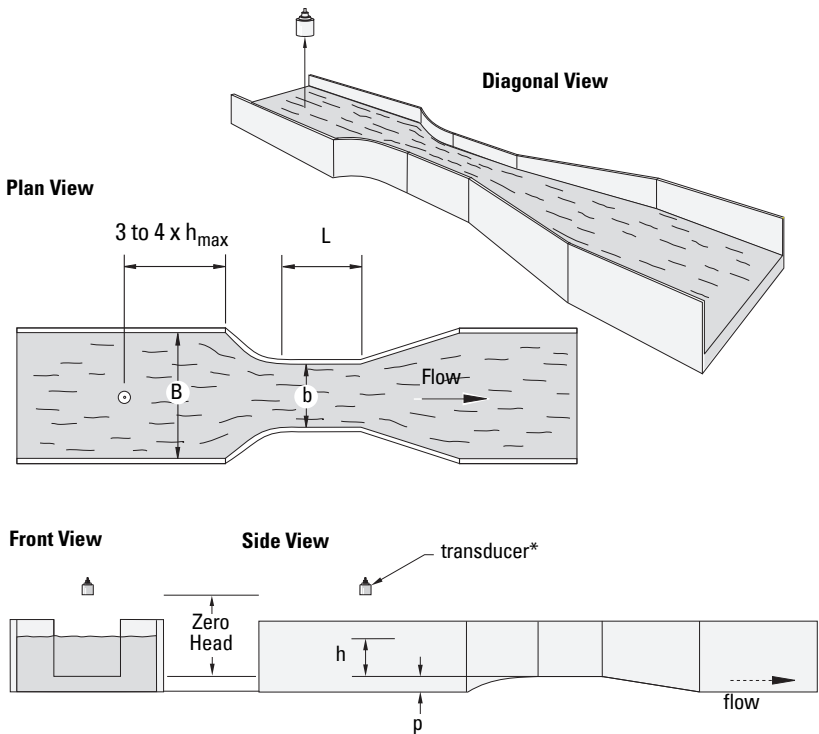

* The transducer must be above the maximum head by at least the blanking value (see 2.2.4. Near Range).

Parameter	Value
2.15.1. Primary Measuring Device (PMD)	BS-3680 Rectangular Flume
2.15.4. PMD Dimensions	Approach width (B)
	Throat width (b)
	Hump Height (p)
	Throat length (L)
2.15.3.5. Zero Head Offset	
2.15.3.7. Flowrate Units	
2.15.3.1. Method of Flow Calculation	
2.15.3.4. Maximum Flow at 20 mA	

BS- 3680 Round Nose Horizontal Crest Weir

Diagonal View

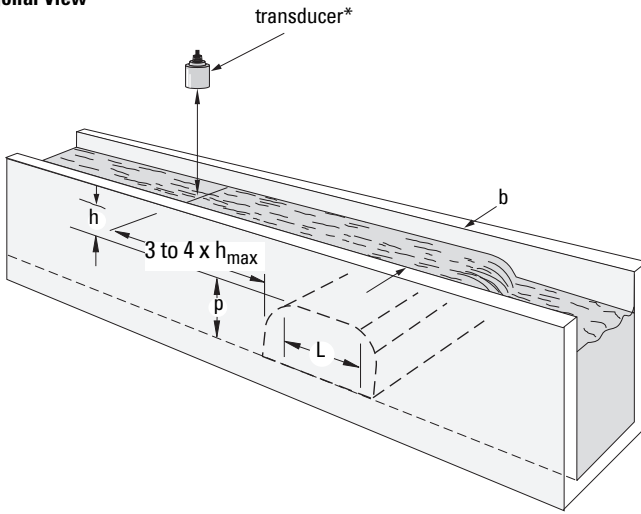

* The transducer must be above the maximum head by at least the blanking value (see 2.2.4. *Near Range*).

Parameter	Value
2.15.1. Primary Measuring Device (PMD)	BS-3680 Round Nose Horizontal Crest Weir
2.15.4. PMD Dimensions	Crest Width b
	Crest Height p
	Crest Length L
2.15.3.3. Maximum Head	
2.2.5. Far Range	
2.15.3.7. Flowrate Units	
2.15.3.1. Method of Flow Calculation	
2.15.3.4. Maximum Flow at 20 mA	

BS- 3680 Trapezoidal Flume

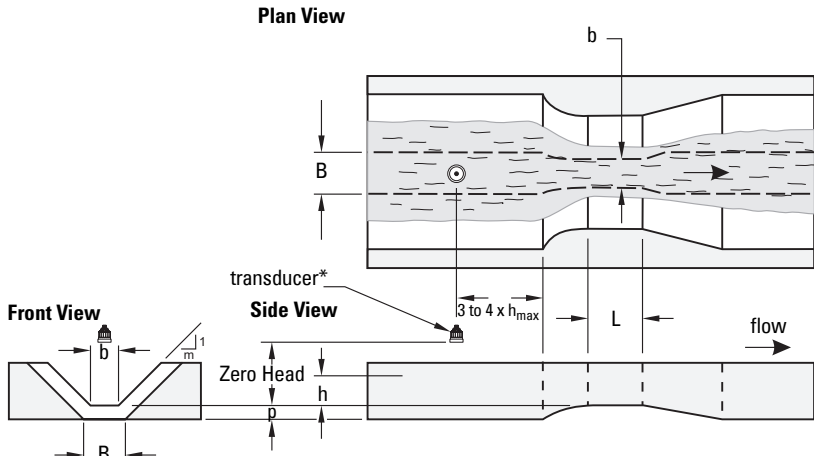

* The transducer must be above the maximum head by at least the blanking value (see 2.2.4. Near Range).

Parameter	Value
2.15.1. Primary Measuring Device (PMD)	BS-3680 Trapezoidal Flume
2.15.4. PMD Dimensions	Slope m
	Approach Width B
	Throat Width b
	Hump Height p
	Throat length L
2.15.3.3. Maximum Head	
2.2.5. Far Range	
2.15.3.7. Flowrate Units	
2.15.3.1. Method of Flow Calculation	
2.15.3.4. Maximum Flow at 20 mA	

General Operation

BS- 3680 U-Flume

Diagonal View

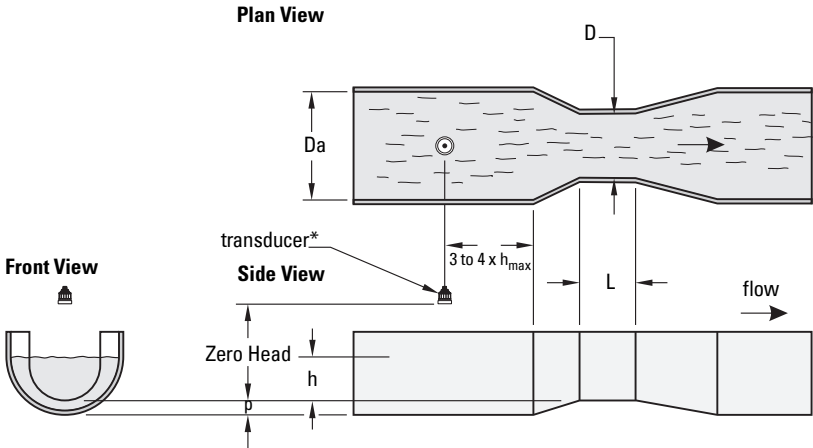
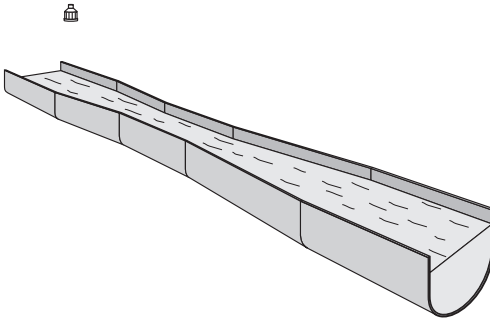

* The transducer must be above the maximum head by at least the blanking value (see 2.2.4. Near Range).

Parameter	Value
2.15.1. Primary Measuring Device (PMD)	BS-3680 U-Flume
2.15.4. PMD Dimensions	Approach Diameter D_a
	Throat Diameter D
	Hump Height p
	Throat Length L
2.15.3.3. Maximum Head	
2.2.5. Far Range	
2.15.3.7. Flowrate Units	
2.15.3.1. Method of Flow Calculation	
2.15.3.4. Maximum Flow at 20 mA	

BS- 3680 Finite Crest Weir

Diagonal View

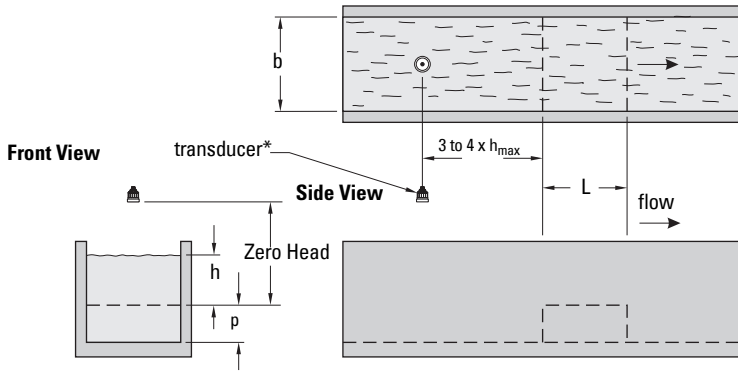
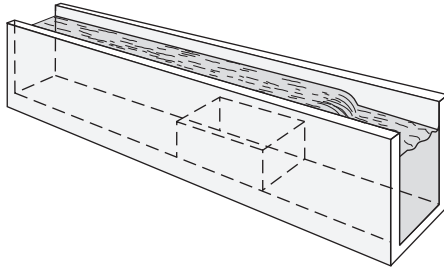

* The transducer must be above the maximum head by at least the blanking value (see 2.2.4. Near Range).

Parameter	Value
2.15.1. Primary Measuring Device (PMD)	BS-3680 Finite Crest Weir
2.15.4. PMD Dimensions	Crest Width b
	Crest Height p
	Crest Length L
2.15.3.3. Maximum Head	
2.2.5. Far Range	
2.15.3.7. Flowrate Units	
2.15.3.1. Method of Flow Calculation	
2.15.3.4. Maximum Flow at 20 mA	

BS- 3680 Thin Plate Rectangular Weir

Diagonal View

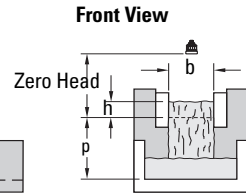
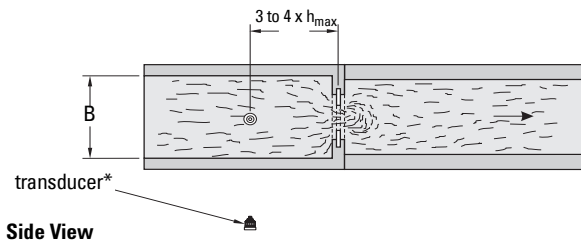
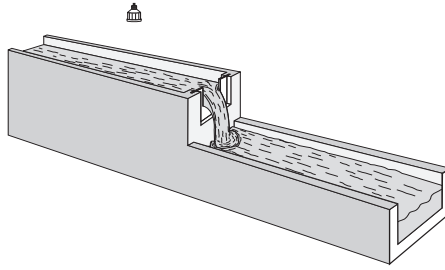

* The transducer must be above the maximum head by at least the blanking value (see 2.2.4. *Near Range*).

Parameter	Value
2.15.1. Primary Measuring Device (PMD)	BS-3680 Thin Plate Rectangular Weir
2.15.4. PMD Dimensions	Approach Width B
	Crest Width b
	Crest Height p
2.15.3.3. Maximum Head	
2.2.5. Far Range	
2.15.3.7. Flowrate Units	
2.15.3.1. Method of Flow Calculation	
2.15.3.4. Maximum Flow at 20 mA	

BS- 3680 Thin Plate V-Notch Weir

Diagonal View

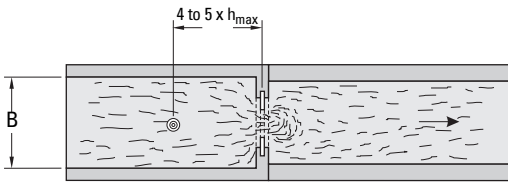
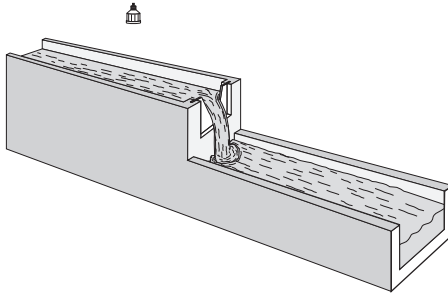

Side View

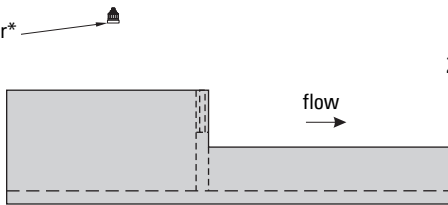

Front View

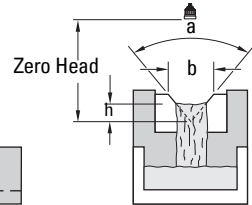

* The transducer must be above the maximum head by at least the blanking value (see 2.2.4. Near Range).

Parameter	Value
2.15.1. Primary Measuring Device (PMD)	BS-3680 Thin Plate V-Notch Weir
2.15.4. PMD Dimensions	Notch angle (a)
2.15.3.3. Maximum Head	
2.2.5. Far Range	
2.15.3.7. Flowrate Units	
2.15.3.1. Method of Flow Calculation	
2.15.3.4. Maximum Flow at 20 mA	

General Operation

Rectangular Weir Contracted

Diagonal View

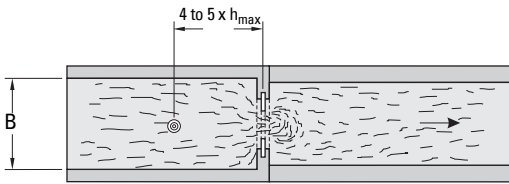
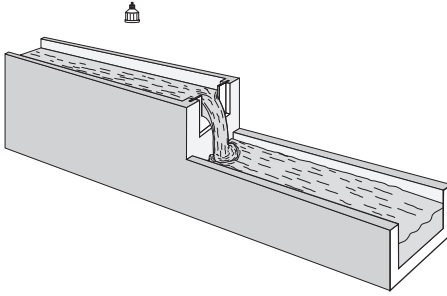

transducer*

Side View

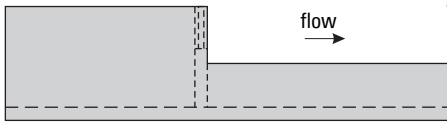

Front View

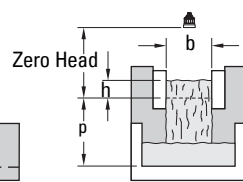

* The transducer must be above the maximum head by at least the blanking value (see 2.2.4. *Near Range*).

Parameter	Value
2.15.1. Primary Measuring Device (PMD)	Rectangular Weir Contracted
2.15.4. PMD Dimensions	Crest Width b
2.15.3.3. Maximum Head	
2.2.5. Far Range	
2.15.3.7. Flowrate Units	
2.15.3.1. Method of Flow Calculation	
2.15.3.4. Maximum Flow at 20 mA	

Round Pipe

Diagonal View

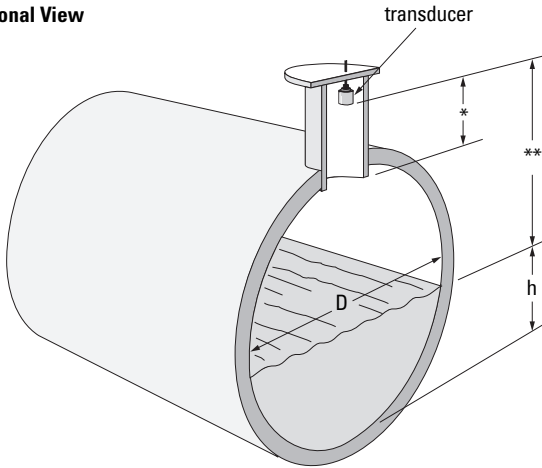

* This dimension should be at least 15 cm (6") shorter than the blanking value (see 2.2.4. *Near Range*).

** The transducer must be above the maximum head by at least the blanking value.

Parameter	Value
2.15.1. Primary Measuring Device (PMD)	Round Pipe
2.15.4. PMD Dimensions	Pipe Inside Diameter D
	Slope (fall/run) s
	Roughness Coefficient n
2.15.3.3. Maximum Head	
2.2.5. Far Range	
2.15.3.7. Flowrate Units	
2.15.3.1. Method of Flow Calculation	
2.15.3.4. Maximum Flow at 20 mA	

Palmer Bowlus Flume

Plan View

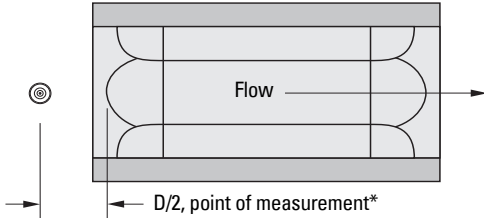

Side View

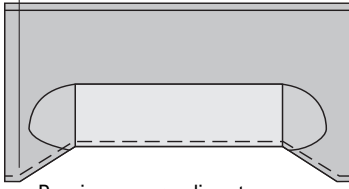

Front View

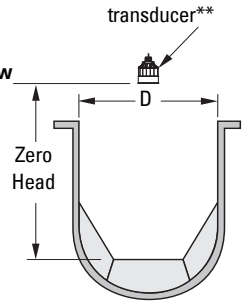

D = pipe or sewer diameter

* for rated flows under free flow conditions

** The transducer must be above the maximum head by at least the blanking value (see 2.2.4. Near Range).

Parameter	Value
2.15.1. Primary Measuring Device (PMD)	Palmer Bowlus Flume
2.15.4. PMD Dimensions	Maximum Flume width h_{max}
2.15.3.3. Maximum Head	
2.15.3.4. Maximum Flow at 20 mA	
2.15.3.5. Zero Head Offset	
2.15.3.7. Flowrate Units	
2.15.3.1. Method of Flow Calculation	Ratiometric

Note: Palmer Bowlus Flume can only be setup using ratiometric calculations

Application information

- Sized by pipe diameter D
- Flume relief is trapezoidal
- Designed to install directly into pipelines and manholes
- Head is referenced to bottom of the throat, not bottom of the pipe
- For rated flows under free flow conditions, the head is measured at a distance of D/2 upstream from the beginning of the converging section

H-Flume

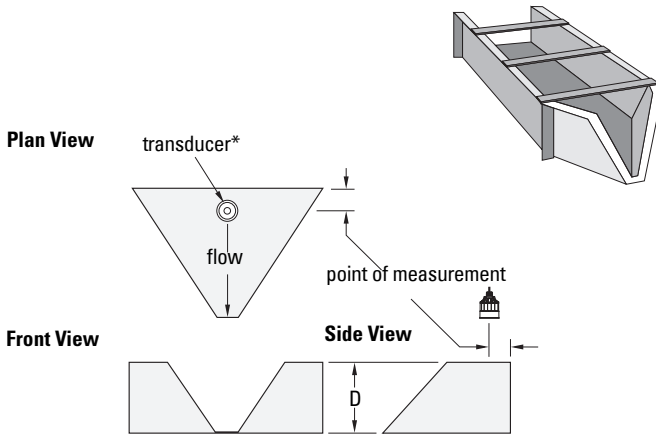

* The transducer must be above the maximum head by at least the blanking value (see 2.2.4. Near Range).

Parameter	Value
2.15.1. Primary Measuring Device (PMD)	H-Flume
2.15.4. PMD Dimensions	Flume height (D)
2.15.3.3. Maximum Head	
2.15.3.4. Maximum Flow at 20 mA	
2.15.3.7. Flowrate Units	
2.15.3.1. Method of Flow Calculation	Ratiometric

Note: H-Flume can only be setup using ratiometric calculations

- Sized by maximum depth of flume
- Approach is preferably rectangular, matching width and depth for distance 3 to 5 times the depth of the flume
- May be installed in channels under partial submergence (ratio of downstream level to head). Typical errors are:
 - 1% @ 30% submergence
 - 3% @ 50% submergence
- For rated flows under free flow conditions, the head is measured at a point downstream from the flume entrance. Refer to the following table.

Flume Size (Diameter in feet)	Point of Measurement	
	cm	inches
0.5	5	1.75
0.75	7	2.75
1.0	9	3.75
1.5	14	5.5

continued on next page

Flume Size (Diameter in feet)	Point of Measurement	
	cm	inches
2.0	18	7.25
2.5	23	9
3.0	28	10.75
4.5	41	16.25

- H-flumes come with a flat or sloping floor. The same flow table can be used because error is less than 1%.

Universal calculation support

When the primary measuring device (PMD) doesn't fit one of the standard types, it can be programmed using a universal characterization. When Universal is selected as the PMD type [2.15.1. *Primary Measuring Device (PMD)*], then both head and flow breakpoints (2.15.5. *Universal Head vs. Flow*) must be entered to define the flow.

SITRANS LUT400 supports Universal curved (cubic spline) flow calculation shown in the following chart. (The 2.15.3.1. *Method of Flow Calculation* for universal support can be Ratiometric or Absolute. Refer to your PMD manufacturer's documentation.)

Typical flow characterization

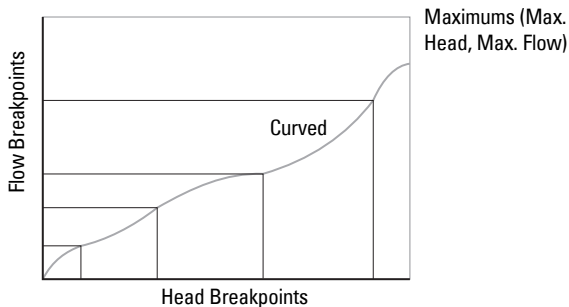

Characterization is achieved by entering the head and corresponding flow breakpoints, either from empirical measurement or from the manufacturer's specification. Increasing the number of defined breakpoints will increase the accuracy of the flow measurement.

Breakpoints should be concentrated in areas exhibiting the higher degrees of non linear flow. A maximum of 32 breakpoints can be defined, with a minimum of four required. The curve's end point is always specified by the parameters 2.15.3.3. *Maximum Head* and 2.15.3.4. *Maximum Flow at 20 mA*. These two parameter values are in addition to the 32 breakpoints available for definition.

Use as many breakpoints as required by the complexity of your PMD.

See *Volume* on page 73 for more information and parameter 2.15.5. *Universal Head vs. Flow* for characterization.

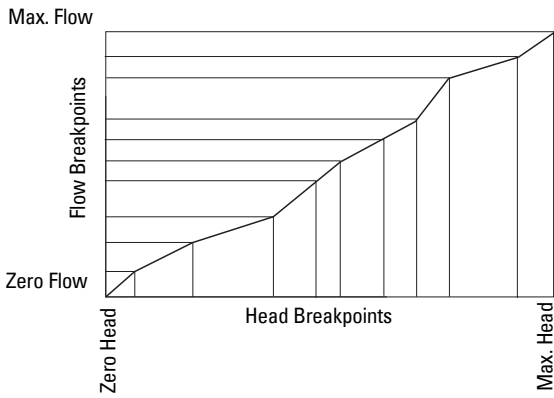

Example flumes

These example flumes would both require a universal calculation.

Trapezoidal

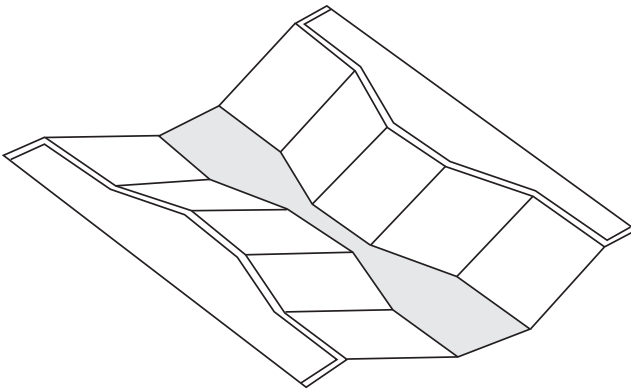

Dual Range (nested) Parshall

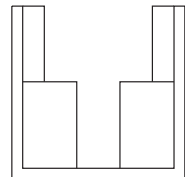
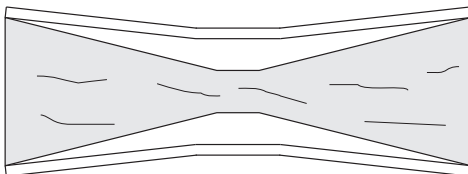

Example weirs

These weirs could require universal calculation.

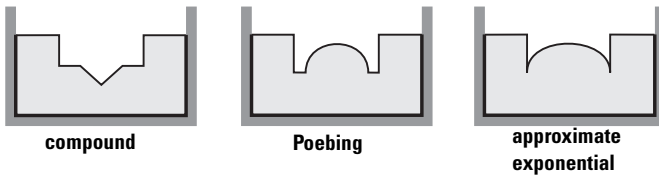

Trends

To view trend lines, navigate to **3. Maintenance and Diagnostics > 3.2. Diagnostics > 3.2.2. Trend**. The PV (in percentage) is logged at five minute intervals and trend displays up to 3000 data points since last power up.

- Press **RIGHT arrow** ► to request a trend.

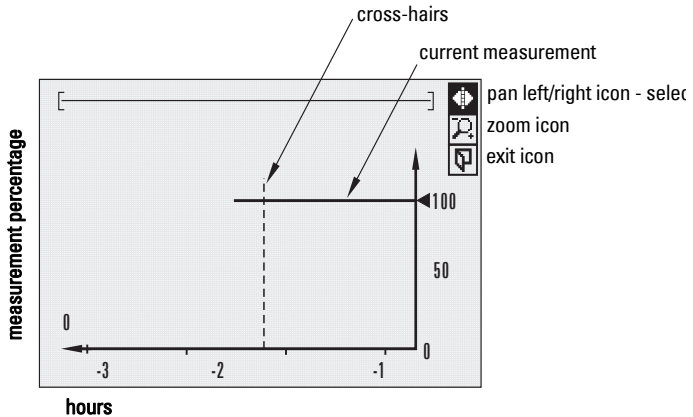

- Use **UP** ▲ or **DOWN arrow** ▼ to scroll to an icon. When an icon is highlighted, that feature becomes active.
- To move the cross-hair, press **RIGHT arrow** ► to increase the value, **LEFT arrow** ◀ to decrease.
- To Zoom into an area, position the cross-hairs at the center of that area, select **Zoom** icon, and press **RIGHT arrow** ►. Press **LEFT arrow** ◀ to Zoom out.
- To return to the previous menu, select **Exit** icon then press **RIGHT arrow** ►.

Notes:

- When a fail-safe condition has occurred, it will appear as a gap in the Trend line.
- Trend view will *not* timeout. This view will display on LUI until the exit icon is selected.

Data logging

The SITRANS LUT400 provides an extensive logging feature which can be viewed on the local display or retrieved via USB port.

Enable data logging for a Process Value, an Alarm, or for Flow (see *2.10. Data Logging* on page 173).

For flow, the logging rate can be fixed or variable. The latter being useful in conserving logging space. The condition for variable logging is determined when selecting the logging rate.

Variable logging rate conditions are categorized as: percent change of flow per minute, percent change of maximum flow or percent change of maximum head. Logging occurs at the normal (slower) rate while the condition is less than the setpoint (*2.10.3.6. Rapid Flow Log Setpoint*). If the condition exceeds the rapid flow log setpoint, the rapid rate of logging takes effect until the condition falls below the standard flow log setpoint (*2.10.3.4. Standard Flow Log Setpoint*).

The setpoints represent the absolute value of the rate of change; that is, for either increasing or decreasing flowrate. The SITRANS LUT400 does not recognize negative entries for standard or rapid flow log setpoints.

Flow data is logged in flowrate units (with full resolution of flow measurement value) from 0 to 110% of maximum flow. Flows above 110% are logged at the 110% value (in flowrate units). Truncation of flows to 110% does not apply to daily totalization.

Viewing the Data Log

To view the data log, navigate to **3. Maintenance and Diagnostics > 3.2. Diagnostics > 3.2.6. View Logs** and select the desired log; Alarms, OCM, PV, or Daily Totals.

The log can be examined locally via LUI, or via USB. On LUI, viewing of the log is done by task and by method. The viewing tasks are: Alarms, OCM, Daily Totals, or Primary Variable (PV). The viewing methods are: by first entry, by last entry and by specified date. The scrolling keys are used to maneuver through the tasks, methods and time of day.

Log Capacity vs. Rates

Rate	Capacity
1 min.	7 days
5	1 month
15	3.5 months
30	7 months
60	1.2 years
24 hr	27.8 years

e.g. rate = 15 / 5, capacity = 3.5 months max / 1 month min

Log files written to a local computer drive via USB, are comma-delimited files. For a list of field names, see *Data Logging* on page 267.

Fault code 129 is displayed on the device when the data log memory becomes full. To clear entries when memory is full:

1. Disable all logging functions that are active (PV log: *2.10.11*, Alarm log: *2.10.21*, Flow log: *2.10.31* or *2.10.32*)
2. Browse to the USB drive on your computer and delete log files (or *move* files from the USB drive to another local computer drive). (If a file is deleted or moved without first disabling the associated logging function, the fault code will not clear.)
3. Re-enable logging functions that were disabled in step 1.

Simulation

The SITRANS LUT400 supports simulation from the LUI. Level and discrete inputs can be simulated, separately or concurrently.

Level simulation

In level simulation, the LCD reacts to the simulated level changes, and activates relays based on the setpoints programmed. The material level can be set to continuously sweep through the measurement range, from Low Calibration Point to High Calibration Point and back again (using *3.4.1.3. Ramp*, *3.4.1.4. Ramp Rate*), or the material level can be held at a specific value (using *3.4.1.2. Level Value*).

Discrete Input simulation

When discrete inputs are simulated, the DI icon on the LCD will show the simulated states of the discrete inputs. Any programming that uses the discrete inputs, such as the backup level override, will use the simulated values.

In simulation mode, some of the LUT400's configured functionality will respond to the simulated value, including:

- **Readings that are based on Level** - The LUT400 supports simulation of Level values only. Other simulated values cannot be entered, however, these values will be calculated correctly when Level is simulated. Space, Distance, Volume, Flow, and Head will be calculated [see Sensor Mode (2.1.2.) on page 138].
- **The milliamp output** - The current loop output will also track the corresponding reading (Level, Space, Distance, Volume, Flow, or Head depending on which of these it is configured to track). [See Current Output Function (2.5.1.) on page 144.]
- **Alarms** - Any alarms that have been configured, including any relays configured for alarms, will activate based on the simulated value. [See Alarms (2.8.) on page 162.]
- **Relays configured for pumps** - If the device is configured for a pump application then the corresponding relay indicators on the LCD will also show when the pumps would activate. By default the relay contacts themselves will not activate in simulation mode, but this behaviour can be changed if desired (see *Pump relay behaviour during simulation* on page 121).
- **Logging** - Log files will reflect the simulated values. This includes logging simulated high-flow/low-flow conditions, and any alarms.

The following functions will not respond to the simulated value when in simulation mode:

- **Fault Conditions** - The LUT400 will never enter the Fail-safe state when in simulation mode. For further details see *Fail-safe and Simulation* on page 122.
- **Backup Level Override** - If a Backup Level Override switch is configured and it lies within the simulated Level range, it will not be simulated. To simulate a Backup Level Override, simulate the discrete input. See *Simulating Discrete Inputs* on page 123.
- **Totalizing of OCM Flow** - Totalizing of flow (OCM applications) does not occur during simulation. The OCM Daily Totalizer (2.16.1) and Running Totalizer (2.16.2) will not increase in value during simulation.
- **Totalizing of Pumped Volume** - Totalizing of pumped volume does not occur during simulation if 3.4.3. *Pump Activations* is set to **Disabled**. If pumps are set to run during simulation, the material pumped will be totalized (2.7.3.1. *Running Totalizer*).
- **External Sampler** - The external sampler, if configured, will click at its timeout interval when in simulation mode (see 2.11.4.3. *Interval*).

Pump relay behaviour during simulation

The 3.4.3. *Pump Activations* parameter allows you to choose how the physical relays that are assigned to pumps will behave when in simulation mode.

This parameter has two possible values:

Disabled: Pump relays are not activated in simulation (default value)

Enabled: Pump relays are activated in simulation

If 3.4.3. *Pump Activations* is **Disabled**, only the LCD indicators are affected (the corresponding relay icons will turn ON, but the relays will not energize). If 3.4.3. *Pump Activations* is **Enabled**, the relay icons will turn ON, and the relays will energize.



WARNING: Select **Enabled** only when there is no possibility of the pumps being damaged during simulation, or if the pumps have been locally disabled through some other means.

Notes:

- If the pump relays are configured to physically activate in simulation mode, then any time activated will be recorded in the pump Run Time parameter (see *Pump Records* on page 202).
- If a pump start delay has been programmed for the device (2.7.2.4.1. *Delay Between Starts*), it will be respected in Simulation mode.

Fail-safe and Simulation

When simulating Level or Discrete Inputs, the LUT400 will never enter the Fail-safe state. Faults that would normally cause a fail-safe condition (such as a broken cable or LOE) may still occur, but a fail-safe condition will not be reported on the device during simulation.

Note: As fail-safe will not be reported during simulation, a bench simulation of the LUT400 can be run without a transducer connected.

HART status

When using HART communications via software tools such as PDM, AMS, FDT, and FC375/475, the Level value and the readings derived from level will display simulated values (when level or discrete input simulation is enabled on LUI). (See *Process Variables* within PDM, AMS, FDT, and FC375/475.) Device status conditions within each tool will also indicate that the device is in simulation mode (see *Diagnostics*).

Simulation process

Simulation is an iterative process whereby parameters are adjusted and corresponding results are viewed in Measurement Mode. Level and Discrete Inputs can be simulated separately, or concurrently. When either simulation is enabled, the LCD displays *Simulation Enabled* in the text area for status messages (see *Measurement mode display: Normal operation* on page 34).

Note: *Simulation Enabled* status will display on LCD even if other faults are present.

To stop simulation at any time, set the parameter for the function being simulated (3.4.1.1. *Level Simulation Enable*, 3.4.2.1. *Discrete Input 1*, 3.4.2.2. *Discrete Input 2*) to **Disabled**.

In general, to run a simulation:

1. Select the function to be simulated: Level or Discrete Input (can be simulated concurrently).
2. Set simulation parameters if performing a Level simulation.
3. Decide if pumps will be active during simulation (see *Pump relay behaviour during simulation* on page 121).
4. Start simulation.

Simulating a fixed level

1. Set the desired fixed level value in 3.4.1.2. *Level Value*.
2. Set 3.4.1.3. *Ramp* to **Disabled**.
3. **Enable** 3.4.3. *Pump Activations* if desired (see *Pump relay behaviour during simulation* on page 121).
4. Set 3.4.1.1. *Level Simulation Enable* to **Enabled** to start level simulation.

Set 3.4.1.1. *Level Simulation Enable* to **Disabled** when you wish to stop level simulation.

Simulating a changing level

1. Set the desired starting level value in *3.4.1.2. Level Value*.
2. Set *3.4.1.3. Ramp* to **Enabled**.
3. Set *3.4.1.4. Ramp Rate* to the desired speed, e.g. **Medium**.
4. **Enable 3.4.3. Pump Activations** if desired (see *Pump relay behaviour during simulation* on page 121).
5. Set *3.4.1.1. Level Simulation Enable* to **Enabled** to start level simulation.

The simulated level will initially begin ramping up from *Level Value* (increasing level). When the level rises to 100% or falls to 0%, it reverses direction at the same rate.

Set *3.4.1.1. Level Simulation Enable* to **Disabled** when you wish to stop level simulation.

Simulating Discrete Inputs

1. Enable *3.4.3. Pump Activations* if desired (see *Pump relay behaviour during simulation* on page 121).
2. Set the discrete input to be simulated (*3.4.2.1. Discrete Input 1*, *3.4.2.2. Discrete Input 2* or both) to one of the following:
 - **ON**: the discrete input is simulated to be on
 - **OFF**: the discrete input is simulated to be off.

Set parameter(s) for DI to be simulated (*3.4.2.1. Discrete Input 1* and/or *3.4.2.2. Discrete Input 2*) to **Disabled** if you do not wish to simulate a discrete input, or to stop DI simulation that is currently running.

Simulation timeout

Simulation will automatically be disabled and the LUT400 will return to normal measurement and control ten minutes after changing (editing) any simulation parameter (except *Level Value*). When the timeout occurs, parameters used to enable simulation (*Level Simulation Enable*, *Discrete Input 1*, *Discrete Input 2*), as well as *Pump Activations* will switch to **Disabled**, and the message **Simulation Enabled** will no longer display on the LCD. (Device status conditions will also reset in PDM, AMS, FDT, and FC375/475.)

Application test

You can test the application by varying the actual material level (the preferred test method), or by simulating level changes.

If you are testing the application via simulation mode, decide if control devices, such as pumps, are to be operational during simulation by setting the *Pump Activations* parameter (see *Pump relay behaviour during simulation* on page 121).



WARNING: Only enable *Pump Activations* when there is no possibility of the pumps being damaged during simulation, or if the pumps have been locally disabled through some other means.

While the level is being cycled, check the results of the discrete inputs either by closing the circuit externally (preferred), or by setting DI simulation parameter to force the input **ON** or **OFF**. Try all possible combinations to thoroughly test the setup. When simulating a

changing level, run a complete cycle (from Low Calibration Point to High Calibration Point and back again) to verify that the relays operate as expected.

Monitor system performance carefully, under all anticipated operating conditions.

1. When the LUT400 performs exactly as required, programming is complete.
2. If alternate reading units, fail-safe action, or relay operation is desired, update the parameters for the new functionality.
3. If you experience problems with system performance, see *Diagnosing and Troubleshooting* on page 229.

If you cannot observe all possible operating conditions by varying the material level, use *Simulation process* on page 122 to verify programming.

Retest the system each time you adjust any control parameters.

SITRANS LUT400 Communication Systems

The SITRANS LUT400 is an integrated level controller capable of communicating process information to a Supervisory Control and Data Acquisition (SCADA) system, via a HART modem.

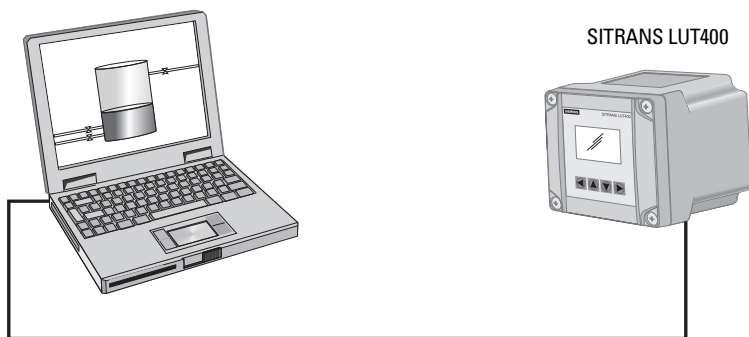

Connection via HART modem.

LUT400 Communications (HART)

Highway Addressable Remote Transducer, HART, is an industrial protocol that is superimposed on the 4-20 mA signal. It is an open standard, and full details about HART can be obtained from the HART Communication Foundation at www.hartcomm.org

SITRANS LUT400 can be configured over the HART network using the HART Communicator 375/475 by Emerson (see *Operation via Field Communicator 375/475 (FC375/FC475) (HART)* on page 133), or a software package. The recommended software package is the SIMATIC Process Device Manager (PDM) by Siemens.

HART Version

SITRANS LUT400 conforms to HART rev. 7.2.

Burst mode

SITRANS LUT400 does not support burst mode.

HART multi-drop mode

HART Multi-drop Mode allows the connection of multiple field devices via HART. To setup a device in Multi-drop Mode, see *Device Address* on page 126. Details on the use of Multi-drop Mode are outlined in an application guide *Working with HART*, which can be downloaded from the product page of our website. Go to:

www.siemens.com/sitransLUT400 under **Support** and click on **Application Guides**.

SIMATIC PDM

This software package is designed to permit easy configuration, monitoring, and troubleshooting of HART devices. The HART EDD for SITRANS LUT400 was written with SIMATIC PDM in mind and has been extensively tested with this software.

For more information, see *Operation via SIMATIC PDM 6 (HART)* on page 127.

HART Electronic Device Description (EDD)

In order to configure a HART device, the configuration software requires the HART Electronic Device Description for the instrument in question.

You can download the HART EDD for SITRANS LUT400 from the product page of our website. Go to: www.siemens.com/sitransLUT400 and click on **Support** > **Software Downloads**.

Older versions of the library will have to be updated in order to use all the features of SITRANS LUT400.

HART Status

Information on HART Status is outlined in an application guide *Working with HART*, which can be downloaded from the product page of our website. Go to:

www.siemens.com/sitransLUT400 under **Support** and click on **Application Guides**.

LUT400 Communication connections

The SITRANS LUT400 can be connected to a computer system via a HART modem (connected to the mA OUT/HART terminal block), or directly connected via a Universal Serial Bus (USB) cable (for use with the Web Browser interface). A HART network requires a device address be configured. For communications via USB, connect SITRANS LUT400 to your computer via the USB cable.

Configuring communication ports

HART modem

Note: It is recommended that only HCF registered modems be used.

Device Address

The unique identifier of the SITRANS LUT400 on a HART network.

Values	Range: 0 to 63 (Set within range of 0 to 15 if HART 5 master used.)
	Default: 0

Set the device address or poll ID on a HART network.

Prior to HART 6, the device address was set to 0 for point to point operation. For HART Multi-drop mode, the device was set to any value other than 0 within the range. (Setting a non-zero address forced the device into fixed current mode.)

With HART 6 and above (version 7.2 supported by LUT400), Multi-drop mode no longer depends on the device address. (However, it is recommended that a non-zero address be set to avoid confusion based on previous HART requirements).

To set the LUT400 in Multi-drop mode, **disable** *Loop current mode* via one of the HART communication software tools (such as SIMATIC PDM). When *Loop current mode* is disabled, a low fixed current is used, allowing for multiple devices to be connected.

Note: Loop current mode can not be disabled via LUI or Web Browser.

See *4.1. Device Address* on page 215.

USB cable

See *Communications* on page 24 for typical setup via USB, then follow instructions under *Installing the USB driver* in the LUT400 Communications manual¹.

Communication troubleshooting

See *Communication Troubleshooting* on page 229 of *Diagnosing and Troubleshooting*.

¹ Communications for SITRANS LUT400 (HART) Manual (7ML19985NE01).

Remote operation

SITRANS LUT400 supports several software tools for operation via remote communications:

- PC running SIMATIC PDM
- PC running Emerson AMS Device Manager
- PC running a web browser
- PC running a Field Device Tool (FDT)
- Field Communicator 375/475 (FC375/FC475).

This section of the manual covers basic information required to use these tools with your SITRANS LUT400. Further details for each are available in the Communications for SITRANS LUT400 (HART) Manual (7ML19985NE01). (See DVD shipped with device or download manual from product page of our website: Go to www.siemens.com/sitransLUT400 > **Technical Info > Manuals/Operating instructions.**)

Operation via SIMATIC PDM 6 (HART)

(SITRANS LUT400 compatible with PDM version 6.1)

Features and Functions

SIMATIC PDM is a software package used to commission and maintain SITRANS LUT400 and other process devices. PDM monitors the process values, alarms and status signals of the device. It allows you to display, compare, adjust, verify, and simulate process device data; also to set schedules for calibration and maintenance. Please consult the LUT400 online help for details on using SIMATIC PDM. (You can find more information at: www.siemens.com/simatic-pdm.)

SIMATIC PDM features four Quick Start Wizards (Level, Volume, Volume-Linearization, and Flow) to easily configure the SITRANS LUT400. A Pump Control Wizard is also available. Other features include Echo Profile Utilities, Manual TVT Shaper adjustment, Auto False Echo Suppression screening, Process Variables monitoring, and Maintenance scheduling.

Parameters are identified by name and organized into function groups. The menu structure for SIMATIC PDM is almost identical to that of the LCD. See *LCD Menu Structure* on page 273 for a chart. For a complete list of parameters, see *Parameter reference (LUI)* on page 137.

Startup and Configuration

To startup the SITRANS LUT400 using SIMATIC PDM, check that you have the latest version of PDM installed (update your installation if necessary - see *SIMATIC PDM version* below), then install the EDD. Next, configure the device using the Quick Start Wizards in PDM.

For more information on SIMATIC PDM functions, and details on how to configure the device using PDM, refer to the LUT400 Communications manual¹.

¹ Communications for SITRANS LUT400 (HART) Manual (7ML19985NE01).

SIMATIC PDM version

Check the support page of our website to make sure you have the latest version of SIMATIC PDM, the most recent Service Pack (SP) and the most recent hot fix (HF). Go to:

<http://support.automation.siemens.com/WWW/llisapi.dll?func=cslib.csinfo&lang=en&objID=10806857&subtype=133100>

Electronic Device Description (EDD)

You can locate the EDD in Device Catalog, under **Sensors/Level/Echo/Siemens AG/SITRANS LUT400**. (The EDD is written for forward compatibility.)

As a guideline to locate the correct EDD, the major and minor numbers should match between the EDD revision and the Firmware revision in the device (e.g. major and minor numbers in bold text: **1.00.00-04**).

To check it in PDM, go to **SITRANS LUT400 HART > Identification > Device**.

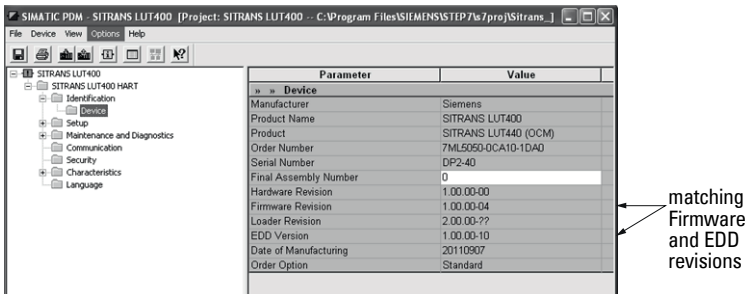

Installing a new version of SIMATIC PDM requires the most recent Service Pack (SP) and the most recent hot fix (HF).

To install a new EDD

- Go to www.siemens.com/sitransLUT400 > **Support > Software Downloads** to download the most up-to-date EDD from the product page of our website.
- Save the files to your computer and extract the zipped file to an easily accessed location.
- Launch **SIMATIC PDM – Manage Device Catalog**, browse to and select the folder which contains the unzipped EDD file.

Operation via Web Browser (USB)

Features and Functions

The web browser interface in SITRANS LUT400, designed to work with Windows XP, makes monitoring and adjustments easy. Internet Explorer installed on a computer can be used to configure the SITRANS LUT400, and the Web Server *Abbyss* is supplied for your convenience. The web browser is available in English only.

SITRANS LUT400 parameters, organized into six main function groups, allow you to configure and monitor the device:

- Identification
- Setup
- Maintenance and Diagnostics
- Communication
- Security
- Language

Startup and Configuration

To startup the SITRANS LUT400 using the Web Browser, you must first install the USB driver and web browser interface. On the small DVD shipped with the device you will find the driver and installation software¹. Once installed, the communication port (COMPORT) must be set, then you can configure the device via the browser menu parameters.

The menu structure for the web browser interface is almost identical to that of the LCD. See *Browser Menu Parameter Function Groups* in the LUT400 Communications manual² for a complete list of parameters that can be configured via the web browser.

For installation instructions and details on how to configure the device via the Web Browser, refer to the LUT400 Communications manual¹.

1. Also available from the product page of our website. Go to: www.siemens.com/sitransLUT400 and click on **Support>Software Downloads**.

2. Communications for SITRANS LUT400 (HART) Manual (7ML19985NE01).

Notes

Operation via AMS Device Manager (HART)

(SITRANS LUT400 compatible with AMS version 10.5 and higher)

Features and Functions

AMS Device Manager is a software package used to commission and maintain SITRANS LUT400 and other process devices. AMS Device Manager monitors the process values, alarms and status signals of the device. It allows you to display, compare, adjust, verify, and simulate process device data. The graphic interface in SITRANS LUT400 makes monitoring and adjustments easy. Please consult the operating instructions or online help for details on using AMS Device Manager. (You can find more information at: <http://www.emersonprocess.com/AMS/>.)

AMS Device Manager features four Quick Start Wizards (Level, Volume, Volume-Linearization, and Flow) to easily configure the SITRANS LUT400. A Pump Control Wizard is also available. Other features include Echo Profile viewing, TVT setup, Process Variables monitoring, and Security.

Parameters organized into three main function groups allow you to configure and monitor the device:

- Configure/Setup
- Device Diagnostics (read only)
- Process Variables (read only)

For a chart¹ of the *AMS Menu Structure*, see LUT400 Communications manual².

Startup and Configuration

To startup the SITRANS LUT400 using AMS Device Manager, you must first install the EDD (see below). You can then configure the device using the Quick Start Wizards in AMS.

For more information on AMS functions, and details on how to configure the device using AMS, refer to the LUT400 Communications manual².

Electronic Device Description (EDD)

SITRANS LUT400 requires the EDD for AMS Device Manager version 10.5.

You can locate the EDD in Device Catalog, under **Sensors/Level/Echo/Siemens/SITRANS LUT400**. Check the product page of our website at www.siemens.com/sitransLUT400, under **Support->Software Downloads**, to make sure you have the latest version of the EDD for AMS Device Manager.

¹ The menu structure for AMS Device Manager is almost identical to that of the LCD.

² Communications for SITRANS LUT400 (HART) Manual (7ML19985NE01).

Notes

Operation via Field Communicator 375/475 (FC375/FC475) (HART)

Features and Functions

The FC375/FC475 HART Communicator is a handheld communication device that is easy to use, and provides universal support for other HART devices, such as the SITRANS LUT400.

For a list of parameters available with the Field Communicator, see *HART FC375/FC475 Menu Structure* in the LUT400 Communications manual¹. This menu structure is very similar to that of AMS Device Manager.

Startup and Configuration

In order to configure this HART device, just as with AMS, the configuration software requires the HART Electronic Device Description (EDD) for the instrument. Once the EDD is installed, you can configure the device using the Quick Start Wizards within FC375/475.

For instructions on how to install the EDD, and how to configure a new device using FC375/475, refer to the LUT400 Communications manual².

¹ Communications for SITRANS LUT400 (HART) Manual (7ML19985NE01).

Notes

Operation via FDT (Field Device Tool)

Features and Functions

FDT is a standard used in several software packages designed to commission and maintain field devices such as SITRANS LUT400. Two commercially available FDTs are PACTware and Fieldcare.

FDT is very similar to PDM [see *Operation via SIMATIC PDM 6 (HART)* in the LUT400 Communications manual¹ for more detail].

- To configure a field device via FDT, you need the DTM (Device Type Manager) for the device.
- To configure a field device via SIMATIC PDM, you need the EDD (Electronic Data Description) for the device.

Startup and Configuration

To startup the SITRANS LUT400 using an FDT, you must first install the DTM (see below). You can then configure the device using the parameters available with the FDT.

The full process to configure a field device via FDT is outlined in an application guide for *SITRANS DTM*, which can be downloaded from the product page of our website. Go to: www.siemens.com/sitransLUT400 under **Support** and click on **Application Guides**.

Device Type Manager (DTM)

A DTM is a type of software that 'plugs into' FDT. It contains the same information as an EDD but an EDD is independent of the operating system.

SITRANS DTM version 3.1

- SITRANS DTM is an EDDL interpreter developed by Siemens to interpret the EDD for that device.
- To use SITRANS DTM to connect to a device, you must first install SITRANS DTM on your system and then install the instrument EDD written for SITRANS DTM.
- You can download SITRANS DTM from our website at: <http://www.siemens.com/sitransdtm>.
Click on **Support** then go to **Software downloads**.

Electronic Device Description (EDD)

The SITRANS LUT400 HART EDD for SITRANS DTM can be downloaded from the product page of our website.

Go to www.siemens.com/sitransLUT400 under **Support** and click on **Software Downloads**.

¹ Communications for SITRANS LUT400 (HART) Manual (7ML19985NE01).

Notes

Parameter reference (LUI)

Notes:

- Parameter names and menu structure are almost identical for SIMATIC PDM and the local user interface (LUI). Access is described below for some parameters that do not appear in the SIMATIC PDM menu structure. **(For further details on using these parameters within SIMATIC PDM, see the LUT400 Communications manual^a.)**
- Default settings in the parameter tables are indicated with an asterisk (*) unless explicitly stated.
- Parameter range values are displayed in the default of the defined unit of measure. For example, if a parameter description states that it is *defined in Units (2.1.1.)*, the range for that parameter will be shown in meters [as meters (M) is the default for Units (2.1.1.)].
- The number of decimals displayed for a parameter value will depend on the unit of measure, unless decimal places can be set by the user (e.g. Totalizers - *2.7.3.2.Totalizer Decimal Position*).
For example:
Values defined in default *2.1.1.Units* will display 3 decimal places; default *2.6.2.Volume Units* - 1 decimal place, default *2.15.3.7.Flowrate Units* - 0 decimal places.
- To enter Program mode using the local push buttons, press ►. Press ◀ to return to Measurement mode.

- a. Communications for SITRANS LUT400 (HART) Manual (7ML19985NE01)

Parameters are identified by name and organized into function groups. See **LCD Menu Structure** on page 273 for a chart.

Parameters accessible via the local push buttons are preceded by a number. Parameters not preceded by a number are accessible only via remote operation.

Based on model configuration (LUT420, LUT430, LUT440), some parameters will not appear on LUI. Exceptions are noted by parameter.

Where the same parameter exists for more than one model, but is represented by a different menu number, both parameters are listed together (separated by "OR"), and the details are noted under the second of the two parameters.

For more details see:

- **Operation via SIMATIC PDM 6 (HART)** on page 127
- **Operation via AMS Device Manager (HART)** on page 131

1. Wizards

Several Wizards are available with the SITRANS LUT400. Wizards group together all the settings needed for a particular feature. All Wizards are available via the local push buttons, and many are also available via SIMATIC PDM under the Device menu.

For details on the Wizards listed below, see **Quick Start Wizards** on page 38 of *Commissioning*.

1.1. Quick Start

1.1.1. QS Level

1.1.2. QS Volume

1.1.3. QS Flow

Available only on LUT430 (Pump and Flow), and LUT440 (OCM) configured models.

1.2. Pump Control

2. Setup

Notes:

- See **Local Commissioning** on page 33 or **Operation via SIMATIC PDM 6 (HART)** on page 127 for instructions.
- Default settings in the parameter tables are indicated with an asterisk (*) unless explicitly stated.
- Values shown in the following tables can be entered via the local push buttons.

2.1. Sensor

2.1.1. Units

Determines sensor measurement units used when 2.1.2.Sensor Mode set to Level, Space, Distance, or Head.

Options	M, CM, MM, FT, IN
	Default: M

2.1.2. Sensor Mode

Menu number 2.1.2 visible on LUT420 (Level model).

OR

2.1.3. Sensor Mode

Menu number 2.1.3 visible on LUT430 (Pump and Flow model), and LUT440 (OCM model).

Sets the type of measurement required for the application.

Options (Mode)		Description	Reference point
*	LEVEL	Distance to material surface	Low Calibration Point (process empty level)
	SPACE		High Calibration Point (process full level)
	DISTANCE		Sensor Reference Point
	VOLUME	Volume of material in volumetric units (based on level)	Low Calibration Point
	HEAD ^a	Distance to material surface	Zero Head
	FLOW ^a	Flowrate in an open channel in Flowrate Units	Zero Head (zero flow level)

^a. Option available only on LUT430, LUT440.

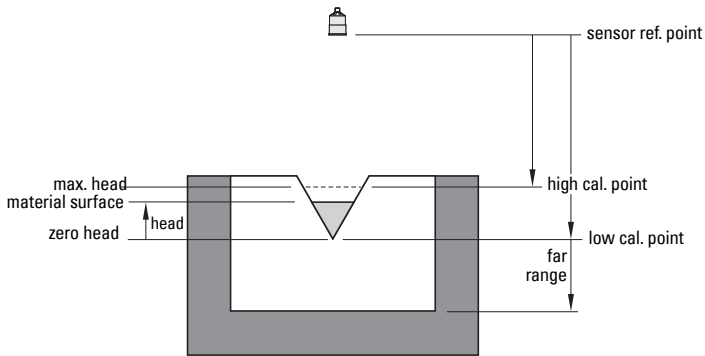
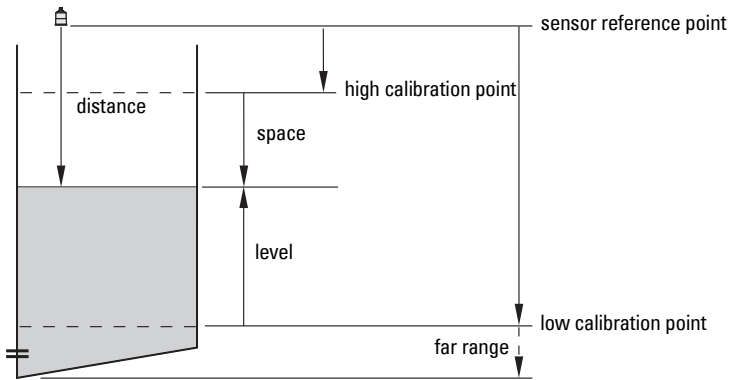

2.1.4. Sensor Mode Secondary

Menu number *2.1.4* visible on LUT420 (Level model).

OR

2.1.5. Sensor Mode Secondary

Menu number *2.1.5* visible on LUT430 (Pump and Flow model), and LUT440 (OCM model).

Sets the secondary measurement type to be used in the application.

See **Sensor Mode (2.1.3.)** for illustration.

2.1.6. Transducer

Specifies the Siemens transducer connected to the device.

Options	*	NO TRANSDUCER
		XRS-5
		XPS-10
		XPS-15
		XCT-8
		XCT-12
		XPS-30
		XPS-40
		XLT-30
		XLT-60
		STH

Notes:

- When **Transducer (2.1.6)** is set to NO TRANSDUCER, the LOE fault will display immediately.
- An **Echo Profile (3.2.1)** cannot be requested from LUI when **Transducer (2.1.6)** is set to NO TRANSDUCER. The local push button will not operate.

2.1.7. Frequency

Adjust the shot transmit pulse frequency (in kHz).

Values	Range: 10.000 to 52.000
	Default: Depends on transducer selected in Transducer (2.1.6.).

2.1.8. Long Shot Duration

Adjust the duration of the long shot transmit pulse (in μ s).

Values	Range: 100.000 to 2000.000
	Default: Depends on transducer selected in Transducer (2.1.6.).

2.1.9. Short Shot Duration

Adjust the duration of the short shot transmit pulse (in μ s).

Values	Range: 100.000 to 2000.000
	Default: Depends on transducer selected in Transducer (2.1.6.).

2.2. Calibration

2.2.1. Low Calibration Point

*Distance from sensor reference point¹ to Low Calibration Point defined in **Units (2.1.1.)**.*

Values	Range: 0.000 to 60.000
	Default: 60.000

¹ The point from which level measurement is referenced (see **Sensor Mode on page 138** for illustration).

2.2.2. High Calibration Point

Distance from sensor reference point¹ to High Calibration Point defined in **Units (2.1.1.)**.

Values	Range: 0.000 to 60.000
	Default: 0.000

When setting the High Calibration Point value, note that echoes are ignored within **2.2.4.Near Range**.

2.2.3. Sensor Offset

The value altered when an **Auto Sensor Offset (2.2.6.)** is performed, defined in **Units (2.1.1.)**.

Values	Range: -99.999 to 99.999
	Default: 0.000

Alternatively, if amount of Sensor Offset is known, enter the constant that can be added to or subtracted from sensor value¹ to compensate if the sensor reference point has shifted.

2.2.4. Near Range

The range in front of the device (measured from the sensor reference point) within which any echoes will be ignored. This is sometimes referred to as blanking or a dead zone. Defined in **Units (2.1.1.)**.

Values	Range: 0.000 to 60.000
	Default: 0.300

2.2.5. Far Range

Note: Far Range can extend beyond the bottom of the vessel.

Allows the material level to drop below Low Calibration Point without generating a Loss of Echo (LOE) state. See **Sensor Mode (2.1.2.)** on page 138 for an illustration. Defined in **Units (2.1.1.)**.

Values	Range: Min. = Low Calibration Point Max. = 61.000 M (200.13 FT)
	Default: Value for Low Calibration Pt. + 1 m (3.281 ft.)

Use this feature if the measured surface can drop below the Low Calibration Point in normal operation.

¹ The value produced by the echo processing which represents the distance from sensor reference point to the target (see **Sensor Mode on page 138** for illustration).

2.2.6. Auto Sensor Offset

Note: Auto Sensor Offset supports adjustments to distance value only.

*Calibrates actual distance if reported value is consistently high or low by a fixed amount. (Adjusts distance measurement by a fixed amount.) Defined in **Units (2.1.1.)**.*

Values	Range: 0.000 to 60.000
---------------	-------------------------------

Before using this feature, verify the following parameters are correct:

- *2.2.1.Low Calibration Point*(or *2.15.3.5.Zero Head Offset*, if using OCM)
- *2.12.1.2.Process Temperature*
- *2.2.3.Sensor Offset*

A correction to any one of these parameters may resolve the issue and an Auto Sensor Offset calibration may not be necessary.

Using Auto Sensor Offset:

Begin with a steady distance at a known low distance value (low distance value equates to a high level value).

1. Review the distance measurement via LUI for approximately 30 seconds to verify repeatability.
2. Measure the actual distance (for example, with a tape measure).
3. Enter the actual distance, defined in **Units (2.1.1.)**

The deviation between the calculated and the actual distance value is stored in *2.2.3.Sensor Offset*.

2.3. Rate

Note: Default settings in the parameter tables are indicated with an asterisk (*) unless explicitly stated.

Notes:

- The following three rate parameters work in conjunction, and are affected by **Response Rate** (set in the Quick Start wizard).
- **Fill Rate per Minute**, **Empty Rate per Minute**, and **Damping Filter** automatically update when **Response Rate** is altered, but any change to these parameters will supersede a Response Rate set previously through the wizard.
- For more information, see **Measurement Response** on page 260.

2.3.1. Fill Rate per Minute

Defines the maximum rate at which the reported level is allowed to increase. Allows you to adjust the SITRANS LUT400 response to increases in the actual material level.

Values	Range: 0.000 to 99999.000 m/min
	Default: 0.100 m/min

Enter a value slightly greater than the vessel's maximum filling rate, in units per minute.

2.3.2. Empty Rate per Minute

Defines the maximum rate at which the reported level is allowed to decrease. Adjusts the SITRANS LUT400 response to decreases in the actual material level.

Values	Range: 0.000 to 99999.000 m/min
	Default: 0.100 m/min

Enter a value slightly greater than the vessel's maximum emptying rate, in units per minute.

2.3.3. Damping Filter

Use this to stabilize the reported level (displayed and analog output), due to level fluctuations (such as a rippling or splashing liquid surface), defined in seconds.

Values	Range: 0.0 to 7200.0
	Default: 100.0

2.4. Fail-Safe

The fail-safe parameters ensure that the devices controlled by the SITRANS LUT400 default to an appropriate state when a valid level reading is not available. The PV region on LUI will display dashes (-----) until the fail-safe fault has been cleared. (See **General Fault Codes** on page 231 for a list of faults that will cause fail-safe.)

Note: When a Loss of Echo occurs **Material Level (2.4.1)** determines the material level to be reported when the Fail-safe timer expires. See **Loss of Echo (LOE)** on page 261 for more detail.

2.4.1. Material Level

Note: The default is a factory setting and depends whether or not your device was ordered as NAMUR NE43-compliant for Fail-safe.

Defines the mA output to use (shown in **Current Output Value**) when the Fail-safe Timer expires and the device is still in an error condition.

Options	HI	20.0 mA (max. mA Limit)
	LO	4.0 mA (min. mA Limit)
	HOLD	Last valid reading
	VALUE	User-selected value [defined in Fail-Safe mA Value (2.4.3) : default 3.58 mA]
Default	VALUE (if ordered with NAMUR NE43 compliant fail-safe preset) HOLD (if ordered without NAMUR NE43 compliant fail-safe preset)	

2.4.2. LOE Timer

Sets the time to elapse since the last valid reading, before the Fail-safe Material Level is reported (defined in seconds).

Values	Range: 0 to 7200
	Default: 100

2.4.3. Fail-Safe mA Value

Note: Material Level (2.4.1.) must be set to **Value** for the **Material Level** value to be reported.

Allows the user to define the mA value to be reported when the Fail-safe timer expires.

Values	Range	3.50 to 22.80 mA
	Default	3.58

2.5. Current Output

Note: Default settings in the parameter tables are indicated with an asterisk (*) unless explicitly stated.

2.5.1. Current Output Function

Menu number *2.5.1.* visible on LUT420 (Level model).

OR

2.5.2. Current Output Function

Menu number *2.5.2.* visible on LUT430 (Pump and Flow model), and LUT440 (OCM model).

Alters the mA output/measurement relationship.

Notes:

- The various options have different reference points.
- Use caution when changing Current Output Function while the device is connected to a HART network. Current Output Function controls the primary value and the loop current for the device.

Options		Reference point	Description
	MANUAL ^a	n/a	user can enter mA value for loop current.
*	LEVEL	Low Calibration Point	measured as difference between the material level and <i>2.2.1.Low Calibration Point</i> , defined in <i>2.1.1.Units</i>
	SPACE	High Calibration Point	measured as difference between the material level and <i>2.2.2.High Calibration Point</i> , defined in <i>2.1.1.Units</i>
	DISTANCE	Sensor reference point	measured as difference between the material level and sensor reference point, defined in <i>2.1.1.Units</i>

	VOLUME	Low Calibration Point	converted from Level, defined in <i>Length of the cylindrical section of a horizontal parabolic end vessel. See Vessel Shape (2.6.1.) for an illustration.</i>
	HEAD ^b	Zero Head	measured as difference between the liquid level and Zero Head, defined in 2.1.1.Units
	FLOW ^b	Zero Head	converted from Head, defined in 2.15.3.7.Flowrate Units

- When Current Output Function is set to **Manual**, a power cycle will reset this parameter to its previous value.
- Option available only on LUT430, LUT440.

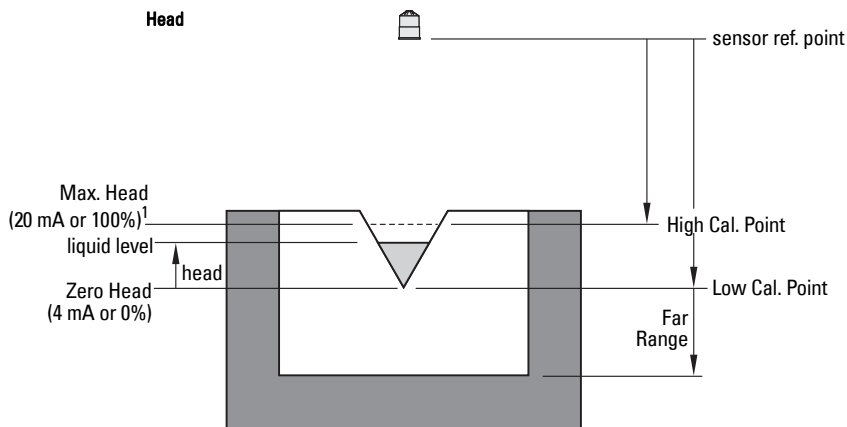
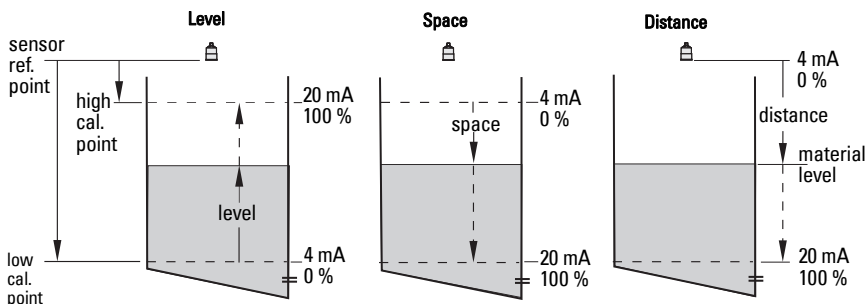

¹. Refer to PMD supplier documentation for maximum head.

To modify Current Output Function via SIMATIC PDM:

Open the menu **Device – Select Analog Output**.

2.5.3. 4 mA Setpoint

*Sets the process level corresponding to the 4 mA value. 4 mA always defaults to 0 m, and **Current Output Function (2.5.1.)** determines the type of measurement. [See **Current Output Function (2.5.1.)** for an illustration.]*

Values	Range: Level, Space, Distance, Head: 0.000 to 60.000 m Volume: 0.0 to Max. Volume Flow: 0 to Max. Flow
	Default: 0 (set to value corresponding to 0% as defined by Current Output Function and associated units)

- Enter the reading that is to correspond to a 4 mA output.
- Units are defined in **Units (2.1.1)** for Level, Space, Distance, or Head, and in **Flowrate Units (2.15.3.7)** for Flow. Volume units are converted from a level value.

2.5.4. 20 mA Setpoint

*Sets the process level corresponding to the 20 mA value. 20 mA always defaults to 60 m, and **Current Output Function (2.5.1.)** determines the type of measurement. [See **Current Output Function (2.5.1.)** for an illustration.]*

Values	Range: Level, Space, Distance, Head: 0.000 to 60.000 m Volume: 0.0 to Max. Volume Flow: 0 to Max. Flow
	Default: Level, Space, Distance, Head: 60.000 Volume: Max. Volume Flow: Max Flow (set to value corresponding to 100% as defined by Current Output Function and associated units)

- Enter the reading that is to correspond to a 20 mA output.
- Units are defined in **Units (2.1.1)** for Level, Space, or Distance, or Head, and in **Flowrate Units (2.15.3.7)** for Flow. Volume units are converted from a level value.

2.5.5. Minimum mA Limit

Prevents the mA output from dropping below this minimum level for a measurement value. This does not restrict the Fail-safe or Manual settings.

Values	Range: 3.5 to 22.8 mA
	Default: 4.0

2.5.6. Maximum mA Limit

Prevents the mA output from rising above this maximum level for a measurement value. This does not restrict the Fail-safe or Manual settings

Values	Range: 3.5 to 22.8 mA
	Default: 20.0

2.5.7. Manual Value

The mA value to use when **Current Output Function (2.5.1.)** is set to **Manual**. Allows you to use a simulated value to test the functioning of the loop. You can enter 4 mA, 20 mA, or any other user-defined value within the range.

Values	Range: 3.5 to 22.8 mA
	Default: 3.58

- First set **Current Output Function (2.5.1.)** to **Manual**.
- Set this parameter to the desired mA value.
- After completing the test, remember to reset **Current Output Function (2.5.1.)** to the previous setting.

Via SIMATIC PDM:

Open the menu **Device – Loop Test**.

2.5.8. Current Output Value

Read only. Displays the current mA value, including a simulated value entered to test the functioning of the loop.

Values	Range: 3.5 to 22.8 mA
---------------	------------------------------



2.6. Volume



Carries out a volume conversion from a level value.

Note: Default settings in the parameter tables are indicated with an asterisk (*) unless explicitly stated.

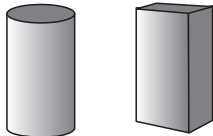
2.6.1. Vessel Shape

89Defines the vessel shape and allows the LUT400 to calculate volume instead of level. If **None** is selected, no volume conversion is performed. Select the vessel shape matching the monitored vessel or reservoir.

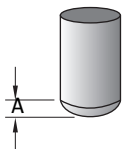
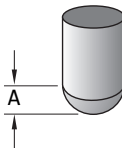
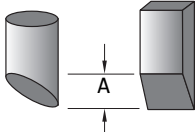
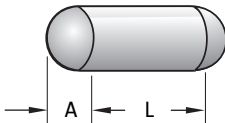
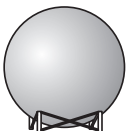
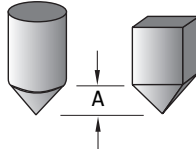
	Vessel Shape	LCD DISPLAY/ Description	Also required
*	None	NONE/ No volume calculation required	N/A
		LINEAR/ Upright, linear (flat bottom)	maximum volume
		CYLINDER/ Flat end horizontal cylinder	maximum volume

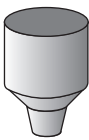
	Vessel Shape (cont'd)	LCD DISPLAY/ Description	Also required
		PARABOLIC BOTTOM	maximum volume, dimension A
		HALF SPHERE BOTTOM	maximum volume, dimension A
		FLAT SLOPED BOTTOM	maximum volume, dimension A
		PARABOLIC ENDS/ Parabolic end horizontal cyl- inder	maximum volume, dimension A, dimension L
		SPHERE	maximum volume
		CONICAL BOTTOM/ Conical or pyramidal bottom	maximum volume, dimension A
		CURVE TABLE ^a / Linearization table (level/volume breakpoints)	maximum volume, tables 1-32 level and volume break- points
		LINEAR TABLE ^a / Linearization table (level/volume breakpoints)	maximum volume, tables 1-32 level and volume break- points

a. Linearization Table must be selected in order for level/volume values [see **Table 1-8 (2.6.7.)**] to be transferred.

2.6.2. Volume Units

Determines volume measurement units used when 2.1.2.Sensor Mode set to VOLUME.

Options	*	L (Litres)
		USGAL (US Gallons)
		IMPGAL (Imperial Gallons)
		CUM (Cubic Meters)
		USER DEFINED (units defined in 2.6.6.User Defined Unit)

2.6.3. Maximum Volume

The maximum volume of the vessel. Enter the vessel volume corresponding to High Calibration Point. For example, if your maximum vessel volume is 8000 L, enter a value of 8000.

Values	Range: 0.0 to 9999999
	Default: 100.0

2.6.4. Dimension A

The height of the vessel bottom when the bottom is conical, pyramidal, parabolic, spherical, or flat -sloped. If the vessel is horizontal with parabolic ends, the depth of the end. See **Vessel Shape (2.6.1.)** for an illustration.

Values	Range: 0.000 to 99.999
	Default: 0.000

Defined in 2.1.1.Units.

2.6.5. Dimension L

Length of the cylindrical section of a horizontal parabolic end vessel. See **Vessel Shape (2.6.1.)** for an illustration.

Values	Range: 0.000 to 99.999
	Default: 0.000

Defined in 2.1.1.Units.

2.6.6. User Defined Unit

Set the unit text to display for current volume when 2.6.2.Volume Units set to user-defined. Limited to 16 ASCII characters.

Note: The text entered is simply for display purposes. No unit conversion occurs.

2.6.7. Table 1-8

*If your vessel shape is more complex than any of the preconfigured shapes, you can define the shape as a series of segments. A value is assigned to each level breakpoint and a corresponding value is assigned to each volume breakpoint. Level values are defined in **Units (2.1.1.)**. Volume values are defined in **Volume Units (2.6.2.)**.*

Level Values	Range: 0.000 to 60.000
	Default: 0.000
Volume Values	Range: 0.0 to 9999999.0
	Default: 0.0

Enter up to 32 level breakpoints, where the corresponding volume is known. The values corresponding to 0% and 100% levels must be entered, and breakpoints can be ordered from top to bottom, or the reverse.

Breakpoints are grouped into four tables: Table 1-8, Table 9-16, Table 17-24, and Table 25-32.

Entering breakpoints via SIMATIC PDM:

- See *Using Linearization via the Quick Start wizard* in the LUT400 Communications manual¹.

Entering breakpoints via the local push buttons:

- a) The default unit for level values is **m**; to change it navigate to **Setup (2.) > Sensor (2.1.) > Units (2.1.1.)**, and select the desired unit.
- b) Navigate to **Setup (2.) > Volume (2.6.) > Table 1-8 (2.6.7.)**, and enter the value.
- c) Go to the appropriate table for the particular breakpoint you wish to adjust: for example, go to Table 1-8 for breakpoint 1.
- d) Under Table 1-8, go to **Level 1 (2.6.7.1.)** to enter the level value for the breakpoint 1.
- e) Under Table 1-8, go to **Volume 1 (2.6.7.2.)** to enter the volume value for the breakpoint 1.
- f) Repeat steps c) to e), until values have been entered for all required breakpoints.

2.6.7.1. Level 1

- a) Press **RIGHT arrow** to open Edit mode.
- b) Enter level value and press **RIGHT arrow** to accept it.
- c) Press **Down ARROW** to move to corresponding volume breakpoint.

2.6.7.2. Volume 1

- a) Press **RIGHT arrow** to open Edit mode.
- b) Enter volume value and press **RIGHT arrow** to accept it.
- c) Press **Down ARROW** to move to next level breakpoint.

¹ Communications for SITRANS LUT400 (HART) Manual (7ML19985NE01)

Example (values are for example purposes only)

Breakpoint number Level value

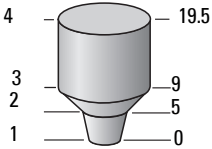

Breakpoint Number	Level value (m)	Volume value (l)
1	0	0
2	5	500
3	9	3000
4	19.5	8000

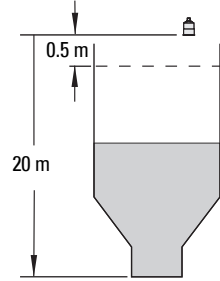

2.6.8. Table 9-16

2.6.9. Table 17-24

2.6.10. Table 25-32

2.7. Pumps

Note: Default settings in the parameter tables are indicated with an asterisk (*) unless explicitly stated.

For details on relay behaviour under fail-safe conditions, see **Pump relays** on page 66.

2.7.1. Basic Setup

2.7.1.1. Pump Control Enable

Enables/disables pump control.

Options		ENABLED
	*	DISABLED

2.7.1.2. Relay Pump 1

Selects the relay assigned to Pump 1.

Options	*	RELAY 2
		RELAY 3

2.7.1.3. Relay Pump 2

Selects the relay assigned to Pump 2.

Options		RELAY 2
	*	RELAY 3

2.7.1.4. Pump Control Mode

Menu number 2.7.1.4. visible on LUT420 (Level model).

OR

2.7.1.5. Pump Control Mode

Menu number 2.7.1.5. visible on LUT430 (Pump and Flow model), and LUT440 (OCM model).

Sets the control algorithm used to trip the relay.

Options	*	ALTERNATE DUTY ASSIST (ADA)	At rotating ON and OFF setpoints and allows multiple pumps to run
		ALTERNATE DUTY BACKUP (ADB)	At rotating ON and OFF setpoints and allows only one pump to run
		SERVICE RATIO DUTY ASSIST (SRA) ^a	On service ratio at ON and OFF setpoints and allows multiple pumps to run
		SERVICE RATIO DUTY BACKUP (SRB) ^a	On service ratio at ON and OFF setpoints and allows only one pump to run
		FIXED DUTY ASSIST (FDA) ^a	At fixed ON and OFF setpoints and allows multiple pumps to run
		FIXED DUTY BACKUP (FDB) ^a	At fixed ON and OFF setpoints and allows only one pump to run

^a. Option available only on LUT430, LUT440.

Each algorithm defines a pump duty and pump start method.

2.7.1.6. ON Setpoint Pump 1

The level at which Pump 1 turns ON, defined in 2.1.1. Units.

Values	Range: 0.000 to 99999.000
	Default: 0.000

This parameter is set according to level even when another reading, such as volume, is shown on the LCD.

2.7.1.7. OFF Setpoint Pump 1

The level at which Pump 1 turns OFF, defined in 2.1.1. Units.

Values	Range: 0.000 to 99999.000
	Default: 0.000

This parameter is set according to level even when another reading, such as volume, is shown on the LCD.

2.7.1.8. ON Setpoint Pump 2

The level at which Pump 2 turns ON, defined in 2.1.1. Units.

Values	Range: 0.000 to 99999.000
	Default: 0.000

This parameter is set according to level even when another reading, such as volume, is shown on the LCD.

2.7.1.9. OFF Setpoint Pump 2

The level at which Pump 2 turns OFF, defined in 2.1.1. Units.

Values	Range: 0.000 to 99999.000
	Default: 0.000

This parameter is set according to level even when another reading, such as volume, is shown on the LCD.

2.7.1.10. Service Ratio Pump 1

Selects pump usage based on the RUN time ratio rather than last used. (See 3.2.7.1.Run Time Relay 2.)

Values	Range: 0 to 255
	Default: 1

This parameter only relates to relays with **Pump Control Mode (2.7.1.4.)** set to Service Ratio Duty Assist or Service Ratio Duty Backup.

The number assigned to each pump relay represents the ratio applied to decide the next pump to start or stop.

Notes:

- The SITRANS LUT400 will not sacrifice other pumping strategies to ensure that the ratio is held true.
- If the pump relays are set to the same value then the ratio equals 1:1 and all pumps are used equally (default).

2.7.1.11. Service Ratio Pump 2

Selects pump usage based on the RUN time ratio rather than last used. (See 3.2.7.2.Run Time Relay 3.)

Values	Range: 0 to 255
	Default: 1

This parameter only relates to relays with **Pump Control Mode (2.7.1.4.)** set to Service Ratio Duty Assist or Service Ratio Duty Backup.

The number assigned to each pump relay represents the ratio applied to decide the next pump to start or stop.

Notes:

- The SITRANS LUT400 will not sacrifice other pumping strategies to ensure that the ratio is held true.
- If the pump relays are set to the same value then the ratio equals 1:1 and all pumps are used equally (default).

2.7.2. Modifiers

Note: Default settings in the parameter tables are indicated with an asterisk (*) unless explicitly stated.

2.7.2.1. Wall Cling Reduction

2.7.2.1.1. Enable

Enables/disables 2.7.2.1.2. Level Setpoint Variation.

Options		ENABLED
	*	DISABLED

2.7.2.1.2. Level Setpoint Variation

Varies the ON and OFF setpoints to reduce material buildup on the walls (defined in 2.1.1. Units).

Values	Range: 0.000 to 99999.000
	Default: 0.000

This value is the range in which the setpoints are allowed to deviate. The pump ON and OFF Setpoint values are randomly varied inside the range to ensure that the material level does not consistently stop at the same point.

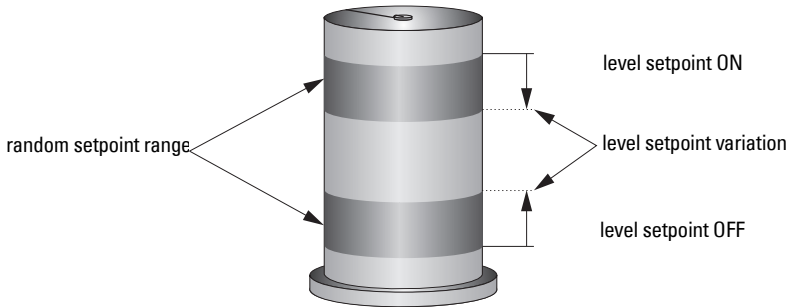

2.7.2.2. Energy Savings

Available only on LUT430 (Pump and Flow model), and LUT440 (OCM model).

Use these parameters to maximize your device's operation during periods of low energy cost and minimize its operation during periods of high cost.

The methods used to achieve this are:

- Emptying the wet well just prior to the high cost period, regardless of material level (2.7.2.2.2. *Peak Lead Time*).
- Changing setpoints for high cost and low cost periods (2.7.2.2.13. *Peak ON Setpoint Pump 1*, 2.7.2.2.14. *Peak OFF Setpoint Pump 1*, 2.7.2.2.3. *Peak 1 Start Time*, 2.7.2.2.4. *Peak 1 End Time*).

One peak lead time is shared by all five peak zones. When one zone's peak time interval (difference between peak start time and peak end time) overlaps another zone's peak lead time, the lead time is chosen over the interval. If a zone's start time matches its end time, the zone is treated as not configured.

2.7.2.2.1. Enable

Enables/disables the Energy Savings feature. The Energy Savings feature is used to minimize the pumping that occurs during periods of high energy cost.

Options	*	DISABLED
		ENABLED

2.7.2.2.2. Peak Lead Time

The time in minutes before the Peak Start Time that the SITRANS LUT400 will begin pumping.

Values	Range: 0 to 65535
	Default: 60

This value determines when pumping should start to ensure the level is as far as possible from the 2.7.1.6. *ON Setpoint Pump 1* level. If level is already within 5% of 2.7.1.7. *OFF Setpoint Pump 1*, no action occurs. If multiple pump stations are series linked, ensure the Peak Lead Time entered is sufficient to attain the desired level in all stations before the high-energy cost period occurs.

2.7.2.2.3. Peak 1 Start Time

Sets the start time of the high energy cost period 1.

Values	Range: 00:00 to 23:59
	Format: HH:MM (24 hour format, e.g. for 5:30pm, set parameter to 17:30)
	Default: 00:00

Used in conjunction with 2.7.2.2.4. *Peak 1 End Time* to define the high cost period.

For instructions on how to edit parameters with a string editor, see **Using the string editor:** on page 187.

2.7.2.2.4. Peak 1 End Time

Sets the end time of the high energy cost period 1.

Values	Range: 00:00 to 23:59
	Format: HH:MM (24 hour format, e.g. for 5:30pm, set parameter to 17:30)
	Default: 00:00

Used in conjunction with 2.7.2.2.3.*Peak 1 Start Time* to define the high cost period.

For instructions on how to edit parameters with a string editor, see **Using the string editor:** on page 187.

2.7.2.2.5. Peak 2 Start Time

Sets the start time of the high energy cost period 2.

Values	Range: 00:00 to 23:59
	Format: HH:MM (24 hour format, e.g. for 5:30pm, set parameter to 17:30)
	Default: 00:00

Used in conjunction with 2.7.2.2.6.*Peak 2 End Time* to define the high cost period.

2.7.2.2.6. Peak 2 End Time

Sets the end time of the high energy cost period 2.

Values	Range: 00:00 to 23:59
	Format: HH:MM (24 hour format, e.g. for 5:30pm, set parameter to 17:30)
	Default: 00:00

Used in conjunction with 2.7.2.2.5.*Peak 2 Start Time* to define the high cost period.

2.7.2.2.7. Peak 3 Start Time

Sets the start time of the high energy cost period 3.

Values	Range: 00:00 to 23:59
	Format: HH:MM (24 hour format, e.g. for 5:30pm, set parameter to 17:30)
	Default: 00:00

Used in conjunction with 2.7.2.2.8.*Peak 3 End Time* to define the high cost period.

2.7.2.2.8. Peak 3 End Time

Sets the end time of the high energy cost period 3.

Values	Range: 00:00 to 23:59
	Format: HH:MM (24 hour format, e.g. for 5:30pm, set parameter to 17:30)
	Default: 00:00

Used in conjunction with 2.7.2.2.7.*Peak 3 Start Time* to define the high cost period.

2.7.2.2.9. Peak 4 Start Time

Sets the start time of the high energy cost period 4.

Values	Range: 00:00 to 23:59
	Format: HH:MM (24 hour format, e.g. for 5:30pm, set parameter to 17:30)
	Default: 00:00

Used in conjunction with 2.7.2.2.10.*Peak 4 End Time* to define the high cost period.

2.7.2.2.10. Peak 4 End Time

Sets the end time of the high energy cost period 4.

Values	Range: 00:00 to 23:59
	Format: HH:MM (24 hour format, e.g. for 5:30pm, set parameter to 17:30)
	Default: 00:00

Used in conjunction with 2.7.2.2.9.*Peak 4 Start Time* to define the high cost period.

2.7.2.2.11. Peak 5 Start Time

Sets the start time of the high energy cost period 5.

Values	Range: 00:00 to 23:59
	Format: HH:MM (24 hour format, e.g. for 5:30pm, set parameter to 17:30)
	Default: 00:00

Used in conjunction with 2.7.2.2.12.*Peak 5 End Time* to define the high cost period.

2.7.2.2.12. Peak 5 End Time

Sets the end time of the high energy cost period 5.

Values	Range: 00:00 to 23:59
	Format: HH:MM (24 hour format, e.g. for 5:30pm, set parameter to 17:30)
	Default: 00:00

Used in conjunction with 2.7.2.2.11.*Peak 5 Start Time* to define the high cost period.

2.7.2.2.13. Peak ON Setpoint Pump 1

Sets the process point at which Pump 1 will turn on when in a peak period.

Values	Range: 0.000 to 99999.000
	Default: 0.000

To allow the level to go beyond the normal Relay ON Setpoint before a pump is started, enter the value to be used for the high-energy cost period.

2.7.2.2.14. Peak OFF Setpoint Pump 1

Sets the process point at which Pump 1 will turn off when in a peak period.

Values	Range: 0.000 to 99999.000
	Default: 0.000

To stop the pump(s) before the normal relay OFF Setpoint and reduce pump-running time. Enter the value to be used for the high cost period.

2.7.2.2.15. Peak ON Setpoint Pump 2

Sets the process point at which Pump 2 will turn on when in a peak period.

Values	Range: 0.000 to 99999.000
	Default: 0.000

To allow the level to go beyond the normal Relay ON Setpoint before a pump is started, enter the value to be used for the high-energy cost period.

2.7.2.2.16. Peak OFF Setpoint Pump 2

Sets the process point at which Pump 2 will turn off when in a peak period.

Values	Range: 0.000 to 99999.000
	Default: 0.000

To stop the pump(s) before the normal relay OFF Setpoint and reduce pump-running time. Enter the value to be used for the high cost period.

2.7.2.3. Pump Run-On

Available only on LUT430 (Pump and Flow model) and LUT440 (OCM model).

*For details on relay behaviour under fail-safe conditions, see **Pump relays** on page 66.*

2.7.2.3.1. Enable

Enables/disables Pump Run-On.

Options		ENABLED
	*	DISABLED

2.7.2.3.2. Run-On Interval

The number of hours between pump run-on occurrences.

Values	Range: 0.00 to 1000.00
	Default: 0.00

To clear sediment in a pump-down wet well, run the pump after the normal OFF setpoint is reached to force some solid material through. This parameter sets the time between such events. Only the last pump running can run-on.

2.7.2.3.3. Run-On Duration Pump 1

The number of seconds that the pump will run-on.

Values	Range: 0 to 65535
	Default: 0

Each pump capacity will determine the amount of material that can be removed. Choose a value long enough to clean out the vessel bottom, yet short enough not to run the pump dry. Also be sure that this value does not overlap with **Run-On Interval (2.7.2.3.2.)**.

2.7.2.3.4. Run-On Duration Pump 2

The number of seconds that the pump will run-on.

Values	Range: 0 to 65535
	Default: 0

Each pump capacity will determine the amount of material that can be removed. Choose a value long enough to clean out the vessel bottom, yet short enough not to run the pump dry. Also be sure that this value does not overlap with **Run-On Interval (2.7.2.3.2.)**.

2.7.2.4. Pump Start Delays

Available only on LUT430 (Pump and Flow model), and LUT440 (OCM model).

2.7.2.4.1. Delay Between Starts

The minimum delay (in seconds) between pump starts.

Values	Range: 0 to 65535
	Default: 10

Use this feature to reduce a power surge from all pumps starting at the same time. This delay determines when the next pump is permitted to start.

Note: If a delay is configured, it will be respected when in simulation mode (see **Pump relay behaviour during simulation** on page 121).

2.7.2.4.2. Power Resumption Delay

The minimum delay (in seconds) before the first pump restart after a power failure.

Values	Range: 0 to 65535
	Default: 60

This reduces the power surge from multiple instruments starting their pumps immediately on power resumption. When this delay expires, other pumps will start as per 2.7.2.4.1.Delay Between Starts.

2.7.3. Totalizers

Available only on LUT430 (Pump and Flow model), and LUT440 (OCM model).

Note: Default settings in the parameter tables are indicated with an asterisk (*) unless explicitly stated.

2.7.3.1. Running Totalizer

Current pumped volume totalizer value in 2.6.2.Volume Units.

Values	Range: 0.00 to 999999999
	Default: 0.00

Pumped volume is automatically calculated whenever both Volume and Pumps are configured.

2.7.3.2. Totalizer Decimal Position

Sets the maximum number of decimal places to be displayed on the LCD.

Options		NO DIGITS	No digits after the decimal position
		1 DIGIT	1 digit after the decimal point
	*	2 DIGITS	2 digits after the decimal point
		3 DIGITS	3 digits after the decimal point

2.7.3.3. Totalizer Multiplier

Use this feature if the LCD Total increments by an amount that is too large (or too small).

Options		.001
		.01
		.1
	*	1
		10
		100
		1000
		10,000
		100,000
		1,000,000
	10,000,000	

Enter the factor by which actual volume is divided, prior to display on LCD. Use a value such that the nine-digit totalizer doesn't roll over between readings.

Example:

For an LCD Total display in 1000s of volume units, enter **1000**. In this example, **10,000** volume units would display as **10**.

2.7.3.4. Inflow/Discharge Adjust

Determines how inflow (or discharge) adjustment is made.

Options	*	BASED ON RATE ESTIMATION	The inflow rate measured just prior to the start of the pump cycle is used to estimate the inflow for the duration of the cycle.
		BASED ON PUMP CYCLE	The inflow is calculated using the change of volume between the end of the last pump cycle and the start of the next one, and the time period between the last cycle and the current one.
		NO ADJUSTMENT	No inflow adjustment is made (assumes an inflow of zero).

For an illustration, see **Pump Totalizers** on page 264.

2.7.3.5. Reset Running Totalizer

Select **YES** to reset pumped volume totalizer value to zero.

Options	*	NO
		YES

2.8. Alarms

The SITRANS LUT400 supports eight alarm types. Any alarm can be assigned to any available relay.

It is possible to assign more than one alarm to the same relay. In this case, the relay will activate if any one of the alarms is activated. If no alarms are activated, the relay will become inactive.

For details on relay behaviour under fail-safe conditions, see **Alarm relays** on page 66.

Note: Default settings in the parameter tables are indicated with an asterisk (*) unless explicitly stated.

2.8.1. High Level Alarm

Reported when material level is within a user-defined range (see 2.8.1.2.High Level Value ON and 2.8.1.3.High Level Value OFF).

Can be used in conjunction with 2.8.12.Time To Spill feature.

2.8.1.1. Enable

Enables/disables High Level Alarm.

Options		ENABLED
	*	DISABLED

2.8.1.2. High Level Value ON

Sets the material level (defined in 2.1.1.Units) at which the High Level Alarm will activate.

Values	Range: 0.000 to 99999.000
	Default: 0.000

Value must be lower than Level To Spill (2.8.12.1.) if Time to Spill feature is used.

2.8.1.3. High Level Value OFF

Sets the material level (defined in 2.1.1.Units) at which the High Level Alarm will de-activate.

Values	Range: 0.000 to 99999.000
	Default: 0.000

2.8.1.4. Assigned Relay

Determines which relay (if any) will be activated when the High Level Alarm activates.

Options	*	NO RELAY
		RELAY 1
		RELAY 2
		RELAY 3

2.8.1.5. Alarm State

Read only. Used to view the current state of the High Level Alarm.

Options	ACTIVE
	INACTIVE

2.8.2. Low Level Alarm

Reported when material level is within a user-defined range (see 2.8.2.2.Low Level Value ON and 2.8.2.3.Low Level Value OFF).

2.8.2.1. Enable

Enables/disables Low Level Alarm.

Options		ENABLED
	*	DISABLED

2.8.2.2. Low Level Value ON

Sets the material level (defined in 2.1.1.Units) at which the Low Level Alarm will activate.

Values	Range: 0.000 to 99999.000
	Default: 0.000

2.8.2.3. Low Level Value OFF

Sets the material level (defined in 2.1.1.Units) at which the Low Level Alarm will de-activate.

Values	Range: 0.000 to 99999.000
	Default: 0.000

2.8.2.4. Assigned Relay

Determines which relay (if any) will be activated when the Low Level Alarm activates.

Options	*	NO RELAY
		RELAY 1
		RELAY 2
		RELAY 3

2.8.2.5. Alarm State

Read only. Used to view the current state of the Low Level Alarm.

Options	ACTIVE
	INACTIVE

2.8.3. Switch (Discrete Input) Alarm

Reported when Discrete Input (2.8.3.2.Discrete Input Number) is in a pre-defined state (2.8.3.3.Discrete Input State).

2.8.3.1. Enable

Enables/disables Switch Alarm.

Options		ENABLED
	*	DISABLED

2.8.3.2. Discrete Input Number

Determines which discrete input to monitor for Switch Alarm.

Options	*	DISCRETE INPUT 1
		DISCRETE INPUT 2

2.8.3.3. Discrete Input State

Sets the state of the discrete input (2.8.3.2.Discrete Input Number) that will cause the Switch Alarm to activate.

Options	*	ON
		OFF

2.8.3.4. Assigned Relay

Determines which relay (if any) will be activated when the Switch Alarm activates.

Options	*	NO RELAY
		RELAY 1
		RELAY 2
		RELAY 3

2.8.3.5. Alarm State

Read only. Used to view the current state of the Switch Alarm.

Options	ACTIVE
	INACTIVE

2.8.4. In-bounds Level Alarm

Reported when material level is within a user-defined range (see 2.8.4.2.High Level Value and 2.8.4.3.Low Level Value).

2.8.4.1. Enable

Enables/disables In-bounds Level Alarm.

Options		ENABLED
	*	DISABLED

2.8.4.2. High Level Value

Sets the upper level value for range within which the In-bounds Level Alarm will activate.

Values	Range: 0.000 to 99999.000
	Default: 0.000

2.8.4.3. Low Level Value

Sets the lower level value for range within which the In-bounds Level Alarm will activate.

Values	Range: 0.000 to 99999.000
	Default: 0.000

2.8.4.4. Assigned Relay

Determines which relay (if any) will be activated when the In-bounds Level Alarm activates.

Options	*	NO RELAY
		RELAY 1
		RELAY 2
		RELAY 3

2.8.4.5. Alarm State

Read only. Used to view the current state of the In-bounds Level Alarm.

Options	ACTIVE
	INACTIVE

2.8.5. Out-of-bounds Level Alarm

Reported when material level is outside a user-defined range (see 2.8.5.2.High Level Value or 2.8.5.3.Low Level Value).

2.8.5.1. Enable

Enables/disables Out-of-bounds Level Alarm.

Options		ENALBED
	*	DISABLED

2.8.5.2. High Level Value

Sets the upper level value for range outside of which the Out-of-bounds Level Alarm will activate.

Values	Range: 0.000 to 99999.000
	Default: 0.000

2.8.5.3. Low Level Value

Sets the lower level value for range outside of which the Out-of-bounds Level Alarm will activate.

Values	Range: 0.000 to 99999.000
	Default: 0.000

2.8.5.4. Assigned Relay

Determines which relay (if any) will be activated when the Out-of-bounds Level Alarm activates.

Options	*	NO RELAY
		RELAY 1
		RELAY 2
		RELAY 3

2.8.5.5. Alarm State

Read only. Used to view the current state of the Out-of-bounds Level Alarm.

Options	ACTIVE
	INACTIVE

2.8.6. Low Temperature Alarm

Reported when process temperature is within a user-defined range (see 2.8.6.2.Low Temperature Value ON and 2.8.6.3.Low Temperature Value OFF).

2.8.6.1. Enable

Enables/disables Low Temperature Alarm.

Options		ENABLED
	*	DISABLED

2.8.6.2. Low Temperature Value ON

Sets the temperature value (defined in °C) at which the Low Temperature Alarm will activate.

Values	Range: -273.0 to +273.0 °C (-459.0 to +523.0 °F)
	Default: 0.0 °C

2.8.6.3. Low Temperature Value OFF

Sets the material level (defined in °C) at which the Low Temperature Alarm will de-activate.

Values	Range: -273.0 to +273.0 °C (-459.0 to +523.0 °F)
	Default: 0.0 °C

2.8.6.4. Assigned Relay

Determines which relay (if any) will be activated when the Low Temperature Alarm activates.

Options	*	NO RELAY
		RELAY 1
		RELAY 2
		RELAY 3

2.8.6.5. Alarm State

Read only. Used to view the current state of the Low Temperature Alarm.

Options	ACTIVE
	INACTIVE

2.8.7. High Temperature Alarm

Reported when process temperature is within a user-defined range (see 2.8.7.2.High Temperature Value ON and 2.8.7.3.High Temperature Value OFF).

The temperature used for the alarm is the same temperature used for sound velocity compensation (see 2.12.1.3.Temperature Source).

2.8.7.1. Enable

Enables/disables High Temperature Alarm.

Options		ENABLED
	*	DISABLED

2.8.7.2. High Temperature Value ON

Sets the temperature value (defined in °C) at which the High Temperature Alarm will activate.

Values	Range: -273.0 to +273.0 °C (-459.0 to +523.0 °F)
	Default: 100.0 °C

2.8.7.3. High Temperature Value OFF

Sets the material level (defined in °C) at which the High Temperature Alarm will de-activate.

Values	Range: -273.0 to +273.0 °C (-459.0 to +523.0 °F)
	Default: 100.0 °C

2.8.7.4. Assigned Relay

Determines which relay (if any) will be activated when the High Temperature Alarm activates.

Options	*	NO RELAY
		RELAY 1
		RELAY 2
		RELAY 3

2.8.7.5. Alarm State

Read only. Used to view the current state of the High Temperature Alarm.

Options	ACTIVE
	INACTIVE

2.8.8. Fail-safe Fault Alarm

Reported when fault that has caused a fail-safe condition is present.

2.8.8.1. Enable

Enables/disables Fail-safe Alarm.

Options		ENABLED
	*	DISABLED

2.8.8.2. Assigned Relay

Determines which relay (if any) will be activated when the Fail-safe Alarm activates.

Options	*	NO RELAY
		RELAY 1
		RELAY 2
		RELAY 3

2.8.8.3. Alarm State

Read only. Use to view the current state of the Fail-safe Alarm.

Options	ACTIVE
	INACTIVE

2.8.9. High Flowrate Alarm

Available only on LUT440 (OCM model).

Reported when the OCM flowrate is within a user-defined range (see 2.8.9.2.High Flowrate Value ON and 2.8.9.3.High Flowrate Value OFF).

2.8.9.1. Enable

Enables/disables High Flowrate Alarm.

Options		ENABLED
	*	DISABLED

2.8.9.2. High Flowrate Value ON

Sets the flowrate value (defined in 2.15.3.7.Flowrate Units) at which the High Flowrate Alarm will activate.

Values	Range: 0 to 9999999
	Default: 0

2.8.9.3. High Flowrate Value OFF

Sets the material level (defined in 2.15.3.7.Flowrate Units) at which the High Flowrate Alarm will de-activate.

Values	Range: 0 to 9999999
	Default: 0

2.8.9.4. Assigned Relay

Determines which relay (if any) will be activated when the High Flowrate Alarm activates.

Options	*	NO RELAY
		RELAY 1
		RELAY 2
		RELAY 3

2.8.9.5. Alarm State

Read only. Used to view the current state of the High Flowrate Alarm.

Options	ACTIVE
	INACTIVE

2.8.10. Low Flowrate Alarm

Available only on LUT440 (OCM model).

Reported when the OCM flowrate is within a user-defined range (see 2.8.10.2.Low Flowrate Value ON and 2.8.10.3.Low Flowrate Value OFF).

2.8.10.1. Enable

Enables/disables Low Flowrate Alarm.

Options		ENABLED
	*	DISABLED

2.8.10.2. Low Flowrate Value ON

Sets the flowrate value (defined in 2.15.3.7.Flowrate Units) at which the Low Flowrate Alarm will activate.

Values	Range: 0 to 9999999
	Default: 0

2.8.10.3. Low Flowrate Value OFF

Sets the material level (defined in 2.15.3.7.Flowrate Units) at which the Low Flowrate Alarm will de-activate.

Values	Range: 0 to 9999999
	Default: 0

2.8.10.4. Assigned Relay

Determines which relay (if any) will be activated when the Low Flowrate Alarm activates.

Options	*	NO RELAY
		RELAY 1
		RELAY 2
		RELAY 3

2.8.10.5. Alarm State

Read only. Used to view the current state of the Low Flowrate Alarm.

Options	ACTIVE
	INACTIVE

2.8.11. Relay Logic

Relay contact operation is NORMALLY CLOSED for alarms and NORMALLY OPEN for controls.

By default an alarm contact is **Normally Closed**. When an alarm activates, the corresponding relay coil is de-energized. By setting this parameter to **Normally Open**, the relay coil will be energized when an alarm assigned to the relay activates.

2.8.11.1. Relay 1 Logic

Use to change the behaviour of Relay 1 when assigned to an alarm.

Options		NORMALLY OPEN
	*	NORMALLY CLOSED

2.8.11.2. Relay 2 Logic

Use to change the behaviour of Relay 2 when assigned to an alarm.

Options		NORMALLY OPEN
	*	NORMALLY CLOSED

2.8.11.3. Relay 3 Logic

Use to change the behaviour of Relay 3 when assigned to an alarm.

Options		NORMALLY OPEN
	*	NORMALLY CLOSED

2.8.12. Time To Spill

Used to predict when an overflow (spill) condition may occur. This feature works in conjunction with the 2.8.1.High Level Alarm.

2.8.12.1. Level To Spill

Value (defined in 2.1.1.Units) representing material level at which a spill will occur.

Options	-999999.000 to 999999.000
	Default: 0.000

This value must be greater than high level alarm ON setpoint [High Level Value ON (2.8.1.2.)].

2.8.12.2. Minutes Left To Spill

Read only. Calculated value representing minutes remaining before a spill will occur.

Enter the level at which a spill condition will occur in 2.8.12.1.Level To Spill. When the High Level Alarm is tripped, the estimated time to spill is displayed in 2.8.12.2.Minutes Left To Spill. The estimated time is calculated by the LUT400 based on the material level and the rate of change of the material level. If the High Level alarm is not tripped, or the material level is falling, then the estimated time to spill will display as zero.

2.9. Discrete Inputs

Discrete inputs are used to trigger or alter the way SITRANS LUT400 controls devices such as pumps and alarms. Discrete inputs can be used for the following:

- as a backup level override
- allowing the device to be more flexible by interlocking control functions with external conditions.

For more detail see **Discrete Inputs** on page 69.

Note: Default settings in the parameter tables are indicated with an asterisk (*) unless explicitly stated.

2.9.1. Backup Level Override

Use this feature to override the material reading by a discrete input such as a contacting point device. The material reading will be fixed at the programmed switch level until the discrete input is released. The LUT400 makes decisions based on the override values.

2.9.1.1. Enable

Enables/disables the Backup Level Override function.

Options		ENABLED
	*	DISABLED

2.9.1.2. Level Override Value

This value is substituted for the current reading when the selected discrete input is enabled and ON.

Values	Range: 0.000 to 60.000
	Default: 0.000

Value is defined in current *2.1.1.Units*, and is valid only for level (and head when *2.1.2.Sensor Mode* set to Flow). (Volume is calculated based on the Backup level.)

2.9.1.3. Discrete Input Number

Sets the discrete input to act as the source for a level reading override when enabled.

Options	*	DISCRETE INPUT 1
		DISCRETE INPUT 2

2.9.2. Discrete Input Logic

Use the following parameters to configure the discrete input itself.

Normal state is standard operation, with the SITRANS LUT400 sensing the material level and controlling the pumps, and no faults or alarms present. The discrete input contacts are either **NORMALLY OPEN** or **NORMALLY CLOSED** when the system state is normal.

Discrete Input Logic	Terminal Block	Discrete Input Scaled State
Normally Open	Voltage applied	ON
	No voltage applied	OFF
Normally Closed	Voltage applied	OFF
	No voltage applied	ON

For example:

When discrete input logic is set to Normally Open and discrete input has no voltage applied on the terminal block, the discrete input will be inactive (OFF).

2.9.2.1. Discrete Input 1 Logic

Use to change the behaviour of the Discrete Input 1.

Options	*	NORMALLY OPEN
		NORMALLY CLOSED

2.9.2.2. Discrete Input 1 Scaled State

Read only. Indicates the current state of Discrete Input 1.

Options		ON
	*	OFF

2.9.2.3. Discrete Input 2 Logic

Use to change the behaviour of Discrete Input 2.

Options	*	NORMALLY OPEN
		NORMALLY CLOSED

2.9.2.4. Discrete Input 2 Scaled State

Read only. Indicates the current state of Discrete Input 2.

Options		ON
	*	OFF

2.9.3. Pump Interlock

Available only on LUT430 (Pump and Flow model), and LUT440 (OCM model). Discrete inputs allow you to supply pump information to the SITRANS LUT400 so that it can modify pump algorithms. The following parameters are used to program actions that should take place when a pump is determined to be in a failed state. For example, a pump interlock can be used to ensure that any pump reporting a failure is removed from the pumping rotation.

2.9.3.1. Enable Pump 1

Enables/disables the pump start interlock. If ON, then Pump 1 will not start if the corresponding discrete input [Pump 1 Discrete Input (2.9.3.2.)] is active.

Options		ENABLED
	*	DISABLED

2.9.3.2. Pump 1 Discrete Input

Sets the discrete input to use for pump start interlock on Pump 1.

Options	*	DISCRETE INPUT 1
		DISCRETE INPUT 2

2.9.3.3. Enable Pump 2

Enables/disables the pump start interlock. If ON, then Pump 2 will not start if the corresponding discrete input [Pump 2 Discrete Input (2.9.3.4.)] is active.

Options		ENABLED
	*	DISABLED

2.9.3.4. Pump 2 Discrete Input

Sets the discrete input to use for pump start interlock on Pump 2.

Options	*	DISCRETE INPUT 1
		DISCRETE INPUT 2

2.10. Data Logging

Use data logging to keep track of a parameter value on regular intervals or when an event is triggered. Up to 3 data logs can be configured, and collectively the logs can hold approximately 30,000 entries. [To view these data logs, see View Logs (3.2.6.).]

Notes:

- No data logs are written while device is connected to a PC via USB.
- Always disable Data Logging before removing log files (when log memory becomes full). See **Viewing the Data Log** on page 119.

2.10.1. Process Value Log

2.10.1.1. Enable

Enables/disables Process Value (PV) Logging.

Options		ENABLED
	*	DISABLED

2.10.1.2. Process Values Log Rate

Sets Process Value (PV) Logging rate in minutes.

Values	Range: 1 to 1440
	Default: 1

2.10.2. Alarm Log

2.10.2.1. Enable

Enables/disables Alarm Logging.

Options		ENABLED
	*	DISABLED

2.10.3. Flow Log

Available only on LUT430 (Pump and Flow model), and LUT440 (OCM model).

Note: Default settings in the parameter tables are indicated with an asterisk (*) unless explicitly stated.

2.10.3.1. Flow Log Mode

Menu number *2.10.3.1* visible on LUT430 (Pump and Flow model).

OR

2.10.3.2. Flow Log Mode

Menu number *2.10.3.2* visible on LUT440 (OCM model).

Sets flow log mode.

Options	*	OFF
		FIXED RATE
		VARIABLE PERCENTAGE MAX FLOW / MIN ^a
		VARIABLE PERCENTAGE MAX FLOW ^a
		VARIABLE PERCENTAGE MAX HEAD ^a

^aOption available only for LUT440.

2.10.3.3. Standard Flow Log Interval

Sets standard flow log interval in minutes, when 2.10.3.1.Flow Log Mode set to a fixed or variable rate.

Values	Range: 1 to 1440
	Default: 1

2.10.3.4. Standard Flow Log Setpoint

Sets standard flow setpoint as a percent based on flow log mode, when 2.10.3.1.Flow Log Mode set to a variable rate.

Values	Range: 0.000 to 110.000
	Default: 0.000

2.10.3.5. Rapid Flow Log Interval

Sets rapid flow log interval in minutes, when 2.10.3.1.Flow Log Mode set to a variable rate.

Values	Range: 1 to 1440
	Default: 1

2.10.3.6. Rapid Flow Log Setpoint

Sets rapid flow setpoint as a percent based on flow logger mode, when 2.10.3.1.Flow Log Mode set to a variable rate.

Values	Range: 0.000 to 110.000
	Default: 0.000

2.11. Other Control

Note: Default settings in the parameter tables are indicated with an asterisk (*) unless explicitly stated.

2.11.1. Elapsed Time Relay

This function drives a relay based on an interval and duration of time. The relay toggles on and off at a rate set by the parameters below. (This relay is not affected by LOE, faults, alarms, or any other condition within the device.)

2.11.1.1. Enable

Enables/disables elapsed time relay control.

Options		ENABLED
	*	DISABLED

2.11.1.2. Interval

The interval in minutes from the activation of the relay until the next activation.

Values	Range: 0.1 to 99999 ^a
	Default: 60.0

^a. Fractional values are allowed, such as 0.5 for 30 seconds

This value must be greater than the 2.11.1.3.Relay Duration or the relay will never reset. The first activation occurs when the device is powered on.

2.11.1.3. Relay Duration

The time in seconds from one change of state in the relay to the next.

Values	Range: 1 to 9999
	Default: 10

This value must be less than the 2.11.1.2.Interval/ or the relay will never reset.

2.11.1.4. Assigned Relay

Determines the relay assigned to elapsed time control.

Options	*	RELAY 1
		RELAY 2
		RELAY 3

2.11.1.5. Relay Logic

Use to change the behaviour of the relay assigned to elapsed time control.

Options	*	NORMALLY OPEN
		NORMALLY CLOSED

Relay contact operation is **NORMALLY CLOSED** for alarms and **NORMALLY OPEN** for controls.

By default a control contact is **Normally Open**. For *2.11.1.3.Relay Duration* the corresponding relay coil is energized. By setting this parameter to **Normally Closed**, the relay coil will be de-energized for the duration phase.

2.11.2. Time of Day Relay

This function drives a relay based on time of day. The relay toggles on and off at a rate set by the parameters below. This relay is not affected by LOE, faults, alarms, or any other condition within the device.

2.11.2.1. Enable

Enables/disables time of day relay control.

Options		ENABLED
	*	DISABLED

2.11.2.2. Activation Time

Sets time of day, using a 24-hour clock, at which the relay should activate.

Values	Range: 00:00 to 23:59
	Format: HH:MM (24 hour format, e.g. for 5:30 pm, set parameter to 17:30)
	Default: 00:00

For instructions on how to edit parameters with a string editor, see **Using the string editor:** on page 187.

2.11.2.3. Relay Duration

The time in seconds from one change of state in the relay to the next.

Values	Range: 1 to 9999
	Default: 10

2.11.2.4. Assigned Relay

Determines the relay assigned to time of day control.

Options	*	RELAY 1
		RELAY 2
		RELAY 3

2.11.2.5. Relay Logic

Use to change the behaviour of the relay assigned to time of day control.

Options	*	NORMALLY OPEN
		NORMALLY CLOSED

Relay contact operation is NORMALLY CLOSED for alarms and NORMALLY OPEN for controls.

By default a control contact is **Normally Open**. For *2.11.2.3. Relay Duration* the corresponding relay coil is energized. By setting this parameter to **Normally Closed**, the relay coil will be de-energized for the duration phase.

2.11.3. External Totalizer

Available only on LUT430 (Pump and Flow model), and LUT440 (OCM model).

*This function tracks the volume of material that passes through a system. The external totalizer controls a relay to signal an external totalizing device. The relay toggles on and off at a rate set by the parameters below. (For details on relay behaviour under fail-safe conditions, see **Miscellaneous relays** on page 66.)*

Note: Default settings in the parameter tables are indicated with an asterisk (*) unless explicitly stated.

2.11.3.1. Enable

Enables/disables external totalizer relay control.

Options		ENABLED
	*	DISABLED

2.11.3.2. Multiplier

Use to scale the external totalizer up or down as required.

Values	Range: 0.0000001 to 99999.000
	Default: 1.000

This allows the totalizer relay to click for different values of volume.

Example:

To click once every 4310 units, set *2.11.3.2. Multiplier* to 4310.

2.11.3.3. Relay Duration

The time in seconds from one change of state in the relay to the next.

Values	Range: 0.1 to 1024.0
	Default: 0.2

2.11.3.4. Assigned Relay

Determines the relay assigned to external totalizer control.

Options	*	RELAY 1
		RELAY 2
		RELAY 3

2.11.3.5. Relay Logic

Use to change the behaviour of the relay assigned to external totalizer control.

Options	*	NORMALLY OPEN
		NORMALLY CLOSED

Relay contact operation is NORMALLY CLOSED for alarms and NORMALLY OPEN for controls.

By default a control contact is **Normally Open**. For *2.11.3.3. Relay Duration* the corresponding relay coil is energized. By setting this parameter to **Normally Closed**, the relay coil will be de-energized for the activation phase.

2.11.4. External Sampler

Available only on LUT430 (Pump and Flow model), and LUT440 (OCM model).

*This function uses a relay to signal a flow sampling device when a certain volume of material has passed through a system (set by the Multiplier), or after a defined period of time (set by the Interval). The relay toggles on and off at a rate set by the parameters below. (For details on relay behaviour under fail-safe conditions, see **Miscellaneous relays** on page 66.)*

Note: Default settings in the parameter tables are indicated with an asterisk (*) unless explicitly stated.

2.11.4.1. Enable

Enables/disables flow sampler relay control.

Options		ENABLED
	*	DISABLED

2.11.4.2. Multiplier

Use to scale the external sampler up or down as required.

Values	Range: 0.0000001 to 99999.000
	Default: 1.000

This allows the sampler relay to click for different values of volume.

Example:

To click once every 4310 flow units, set *2.11.4.2. Multiplier* to 4310.

2.11.4.3. Interval

The time in hours from the activation of the relay until the next activation.

Values	Range: 0.10 to 99999.00
	Default: 1.00

Set the time to activate the relay during low-flow conditions.

2.11.4.4. Relay Duration

The time in seconds from one change of state in the relay to the next.

Values	Range: 0.1 to 1024.0
	Default: 0.2

This value must be less than the *2.11.4.3.Interval* or the relay will never reset.

2.11.4.5. Assigned Relay

Determines the relay assigned to flow sampler control.

Options	*	RELAY 1
		RELAY 2
		RELAY 3

2.11.4.6. Relay Logic

Use to change the behaviour of the relay assigned to flow sampler control.

Options	*	NORMALLY OPEN
		NORMALLY CLOSED

Relay contact operation is NORMALLY CLOSED for alarms and NORMALLY OPEN for controls.

By default a control contact is **Normally Open**. For *2.11.4.3.Interval* the corresponding relay coil is energized. By setting this parameter to **Normally Closed**, the relay coil will be de-energized for the activation phase.

2.12. Signal Processing

Note: Default settings in the parameter tables are indicated with an asterisk (*) unless explicitly stated.

2.12.1. Temperature and Velocity

2.12.1.1. Sound Velocity

*The value adjusted based on the **Sound Velocity at 20 degrees C (2.12.1.5.)** vs. **Process Temperature (2.12.1.2.)** characteristics of air.*

Values	Range: 125.000 to 20000.000 m/s
	Default: 344.130 m/s

Alternatively, enter the current sound velocity (if known), or perform an *2.12.1.6.Auto Sound Velocity* calibration. Value is always reported in m/s.

2.12.1.2. Process Temperature

View the transducer temperature in °C.

If **Temperature Source (2.12.1.3.)** is set to any value other than **Fixed Temperature (2.12.1.4.)**, the value displayed is the temperature measured. If Temperature Source is set to **Temp Fixed**, the **Fixed Temperature (2.12.1.4.)** value is displayed.

2.12.1.3. Temperature Source

Source of the temperature reading used to adjust the speed of sound.

Options	*	TRANSDUCER
		FIXED TEMPERATURE
		EXTERNAL TS-3
		AVERAGE OF SENSORS (Transducer and TS-3)

With this default, the SITRANS LUT400 uses the transducer's internal temperature sensor (standard in all Siemens EchoMax Transducers).

If the transducer does not have an internal temperature sensor, Fixed Temperature value, or an External TS-3 temperature sensor can be used.

If the acoustic beam atmosphere temperature varies with distance from the transducer, connect a TS-3 Temperature Sensor and Ultrasonic/ Temperature Transducer, and select Average of Sensors (Transducer and TS-3).

In gasses other than air, the temperature variation may not correspond with the speed of sound variation. In these cases, turn off the temperature sensor, select value Fixed Temperature, and set a fixed temperature [see **Fixed Temperature (2.12.1.4.)**].

If Ultrasonic/Temperature Transducer, TS-3 Temperature Sensor, or Average of Sensors value is selected, faults on the temperature sensors will be displayed if the sensor appears open or short.

When a transducer temperature sensor fault occurs, Temperature Source can be set to FIXED. This allows the device to continue measuring (and no cable fault will display), until the transducer is replaced. Once replaced, set Temperature Source back to its original setting.

2.12.1.4. Fixed Temperature

Use this feature if a temperature sensing device is not used.

Values	Range: -100.0 to +150.0 °C
	Default: +20.0 °C

Enter the temperature (in °C) of the atmosphere within the transducer acoustic beam. If the temperature varies with distance from the transducer, enter the average temperature.

2.12.1.5. Sound Velocity at 20 degrees C

This value is used to automatically calculate sound velocity.

Values	Range: 125.000 to 20000.000 m/s
	Default: 344.13 m/s

If the acoustic beam atmosphere sound velocity at 20°C (68 °F) is known, and the sound velocity vs. temperature characteristics are similar to that of air (344.1 m/s), enter the sound velocity. Units displayed in meters per second (m/s).

2.12.1.6. Auto Sound Velocity

Note: Auto Sound Velocity supports adjustments to distance value only.

Adjusts the speed of sound and changes the distance measurement calculations. Defined in 2.1.1.Units.

Values	Range: 0.000 to 60.000
---------------	-------------------------------

Condition for use of this feature:

- The acoustic beam atmosphere is other than air
- The acoustic beam atmosphere temperature is unknown
- The Reading accuracy is acceptable at higher material levels only

For best results, calibrate with the level at a known value near Low Calibration Point.

Using Auto Sound Velocity:

Start with a steady distance at a known high distance value (high distance value equates to a low level value).

1. Review the distance measurement via LUI for approximately 30 seconds to verify repeatability.
2. Measure the actual distance (for example, with a tape measure).
3. Enter the actual distance, defined in 2.1.1.Units.

Repeat this procedure if the atmosphere type, concentration, or temperature conditions are different from when the last sound velocity calibration was performed.

Note: In gasses other than air, the temperature variation may not correspond with the speed of sound variation. Turn off temperature sensor and use a fixed temperature.

2.12.2. Echo Select

2.12.2.1. Algorithm

Selects the algorithm to be applied to the echo profile to extract the true echo.

Options	TF	TRUE FIRST	True First echo
	TR	TRACKER	TRacker
	L	LARGEST ECHO	Largest echo
	*	BLF BEST F-L	Best of First and Largest echo
	ALF	AREA LARGEST FIRST	Area, Largest and First

For more details, see **Algorithm** on page 257.

2.12.2.2. Echo Threshold

*Sets the minimum echo confidence that the echo must meet in order to prevent a Loss of Echo condition and the expiration of the Fail-safe (LOE) timer. When **Confidence (3.2.9.2.)** exceeds **Echo Threshold (2.12.2.2.)**, the echo is accepted as a valid echo and is evaluated.*

Values	Range: -20 to 128
	Default: 5

Use this feature when an incorrect material level is reported.

2.12.2.3. Reform Echo

Smooth jagged peaks in the echo profile.

Values	Range: 0 to 50 intervals ^a (greater = wider)
	Default: 0

^a. one interval = span of 24.5 micro seconds

Use this feature when monitoring solids if the reported level fluctuates slightly though the monitored surface is still. Enter the amount (in ms) of Echo Profile smoothing required. When a value is keyed in, the nearest acceptable value is entered.

2.12.2.4. Narrow Echo Filter

Filters out echoes of a specific width.

Values	Range: 0 to 14 intervals ^a (greater = wider)
	Default: 2

^a. one interval = span of 24.5 micro seconds

Use this for transducer acoustic beam interference (e.g. ladder rungs). Enter the width of false echoes (in groups of 25 ms), to be removed from the Echo Profile. [For example, select value of 3 to remove 75 ms (3 x 25 ms) of false echos from the profile.]

When a value is keyed in, the nearest acceptable value is entered.

2.12.2.5. Submergence Detection

Enables/disables submergence detection.

Values		Enabled
	*	Disabled

(Submergence Detection Shield must first be installed on transducer.)

When this parameter is enabled and the transducer becomes submerged:

- fault code 26 is displayed (see **General Fault Codes** on page 231),
- mA output immediately advances to **Minimum mA Limit (2.5.5.)** or **Maximum mA Limit (2.5.6.)**, as defined by the application,
- DISTANCE is set to zero (corresponding to a high level),
- pumps and alarms operate normally (according to level), therefore they remain ON (or activate if not already ON).

The submergence condition remains in effect until the transducer is no longer submerged. A valid echo must then be detected before the LOE Timer expires or the device will enter fail-safe condition (see 2.4. *Fail-Safe*).

2.12.3. TVT Setup

Note: Default settings in the parameter tables are indicated with an asterisk (*) unless explicitly stated.

2.12.3.1. Auto False Echo Suppression

Used together with **Auto False Echo Suppression Range (2.12.3.2.)** to screen out false echoes in a vessel with known obstructions. A 'learned TVT' (time varying threshold) replaces the default TVT over a specified range. See **Shaper Mode and Auto False Echo Suppression** on page 258 for a more detailed explanation.

Notes:

- Make sure material level is below all known obstructions when Auto False Echo Suppression is used to learn the echo profile. (An empty or almost empty vessel is recommended.)
- Note the distance to material level when Auto False Echo learns the environment. Set Auto False Echo Suppression Range to a shorter distance to avoid the material echo being screened out.
- Set Auto False Echo Suppression and Auto False Echo Suppression Range during startup, if possible.
- All other tuning and filter adjustments (such as 2.12.2.4. *Narrow Echo Filter*, 2.12.2.3. *Reform Echo*, 2.12.3.3. *Hover Level*, etc.) should be completed prior to using Auto False Echo Suppression to ensure that the learned profile is representative.

- a) Determine Auto False Echo Suppression Range. Measure the actual distance from the sensor reference point to the material surface using a rope or tape measure.
- b) Subtract 0.5 m (20") from this distance, and use the resulting value.

To set Auto False Echo Suppression via SIMATIC PDM:

Open the menu **Device – Echo Profile Utilities** and click on the tab **Auto False Echo Suppression**.

(For more detailed instructions see *Auto False Echo Suppression* in LUT400 Communications manual¹.)

¹ Communications for SITRANS LUT400 (HART) Manual (7ML19985NE01)

To set **Auto False Echo Suppression** via the local push buttons:

Options		OFF	Default TVT will be used.
	*	ON	'Learned' TVT will be used.
		LEARN	'Learn' the TVT.

- Navigate to **Setup (2.) > Signal Processing (2.12.) > TVT Setup (2.12.3.) > Auto False Echo Suppression Range (2.12.3.2.)**, and enter the value calculated in step b).
- Navigate to **Setup (2.) > Signal Processing (2.12.) > TVT Setup (2.12.3.) > Auto False Echo Suppression (2.12.3.1.)**, and press **RIGHT arrow** to open Edit Mode
- Select **Learn**. The device will automatically revert to **On** (Use Learned TVT) after a few seconds.

2.12.3.2. Auto False Echo Suppression Range

*Specifies the range within which Learned TVT is used (see **Auto False Echo Suppression** on page 183 for more detail).*

Values	Range: 0.000 to 60.000 m
	Default: 1.000

- Calculate range according to **Auto False Echo Suppression (2.12.3.1.)** steps a) and b).
- Press **RIGHT arrow** to open Edit mode.
- Enter the new value and press **RIGHT arrow** to accept it.
- Navigate to **Setup (2.) > Signal Processing (2.12.) > TVT Setup (2.12.3.) > Auto False Echo Suppression (2.12.3.1.)**, and set value.

2.12.3.3. Hover Level

*Defines how high the TVT (Time Varying Threshold) is placed above the noise floor of the echo profile, as a percentage of the difference between the peak of the largest echo in the profile and the noise floor. See **Example before Auto False Echo Suppression** on page 259 for an illustration.*

Values	Range: 0 to 100
	Default: 40

When the device is located in the center of the vessel, the TVT hover level may be lowered to increase the confidence level of the largest echo.

2.12.3.4. Shaper Mode

Enables/disables the TVT shaper.

Options		ON
	*	OFF

Turn TVT Shaper Mode ON before using *2.12.4. TVT Shaper*. Turn the TVT Shaper **ON** and **OFF** while monitoring the effect to pick up the true echo.

2.12.4. TVT Shaper

Adjusts the TVT (Time Varying Threshold) at a specified range (breakpoint on the TVT). This allows you to reshape the TVT to avoid unwanted echoes. There are 40 breakpoints arranged in 5 groups. (We recommend using SIMATIC PDM to access this feature.)

To use TVT shaper via SIMATIC PDM:

- a) Open the menu **Device – Echo Profile Utilities** and click on **TVT Shaper**. (For more details see *TVT Shaper* in LUT400 Communications manual¹.)

To use TVT shaper via local push buttons:

- a) Navigate to **Setup (2.) > Signal Processing (2.12.) > TVT Setup (2.12.3.) > Shaper Mode (2.12.3.4.)**, and select **ON**.
- b) From the TVT Setup menu, **LEFT ARROW** to the Signal Processing menu, and **DOWN ARROW** to TVT Shaper. **RIGHT ARROW** to enter the TVT Shaper menu and **RIGHT ARROW** to edit **Breakpoint 1-8 (2.12.4.1.)**.
- c) Open TVT Breakpoint 1 enter the TVT Offset value (between –50 and 50).
- d) Go to the next TVT Breakpoint and repeat steps c) and d) till all desired breakpoint values have been entered.

2.12.4.1. Breakpoint 1-8

Values	Range: –50 to 50 dB
	Default: 0 dB

2.12.4.2. Breakpoint 9-16

Values	Range: –50 to 50 dB
	Default: 0 dB

2.12.4.3. Breakpoint 17-24

Values	Range: –50 to 50 dB
	Default: 0 dB

2.12.4.4. Breakpoint 25-32

Values	Range: –50 to 50 dB
	Default: 0 dB

2.12.4.5. Breakpoint 33-40

Values	Range: –50 to 50 dB
	Default: 0 dB

¹ Communications for SITRANS LUT400 (HART) Manual (7ML19985NE01)

2.12.5. Measured Values

Read only. Allows you to view measured values for diagnostic purposes.

To access measured values via SIMATIC PDM:

Open the menu **View – Process Variables**.

Note: These parameters will display the simulated value when in simulation mode (see **Simulation process** on page 122).

2.12.5.1. Level Measurement

*The distance to monitored surface referenced from **Low Calibration Point (2.2.1.)**, defined in **Units (2.1.1.)**.*

2.12.5.2. Space Measurement

*The distance to monitored surface referenced from **High Calibration Point (2.2.2.)**, defined in **Units (2.1.1.)**.*

2.12.5.3. Distance Measurement

*The distance to monitored surface referenced from the transducer face (sensor reference point), defined in **Units (2.1.1.)**.*

2.12.5.4. Volume Measurement

*The calculated vessel volume (calculated from level and scaled according to vessel shape) in **Volume Units (2.6.2.)**.*

2.12.5.5. Head Measurement

Available only on LUT430 (Pump and Flow model), and LUT440 (OCM model).

*Corresponds to Head [the distance from **Zero Head Offset (2.15.3.5.)** to the monitored surface in **Units (2.1.1.)**].*

2.12.5.6. Flow Measurement

Available only on LUT430 (Pump and Flow model) and LUT440 (OCM model).

*The calculated flowrate, defined in **Flowrate Units (2.15.3.7.)**.*

2.13. Display

Note: Default settings in the parameter tables are indicated with an asterisk (*) unless explicitly stated.

2.13.1. Local Display Backlight

Time the backlight remains on.

Options		OFF
	*	ON
		TIMED (on for five minutes after key press - takes effect in Measurement View only)

Available only via LUI.

2.13.2. LCD Contrast

The factory setting is for optimum visibility at room temperature and in average light conditions. Extremes of temperature will lessen the contrast.

Values	Range: 0 (Low contrast) to 20 (High contrast)
	Default: 10

Adjust the value to improve visibility in different temperatures and luminosity.
Available only via LUI and web browser.

2.14. Date and Time

Enter the current date and time using the local push buttons.

Parameter **Edit** mode displays a string editor.

Using the string editor:

- Use **RIGHT/LEFT arrow** to select the character position in the parameter field to be edited.

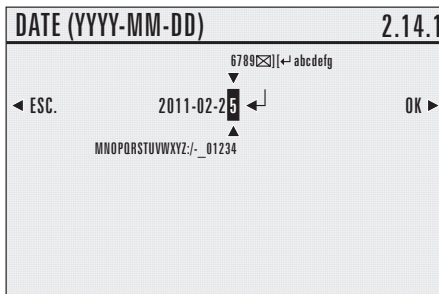

- As each character is highlighted (selected), use the **UP/DOWN arrow** to change the character.
 - Use the **DOWN arrow** to select a character from the string *above* the parameter value.
 - Use the **UP arrow** to select a character from the string *below* the parameter value.
- To escape without saving your changes, press **LEFT arrow** continually until **ESC** is highlighted. Press **LEFT arrow** again to escape without saving changes. Otherwise, when new parameter value is correct, press **RIGHT arrow** continually until **OK** is highlighted.
- Press **RIGHT arrow** to accept the new value. The LCD returns to parameter view and displays the new selection. Review for accuracy.

Special Characters:

Character	Description	Function
:	colon	enters colon in text string
	space	enters space in text string
/	slash	enters slash in text string
-	hyphen	enters hyphen in text string
_	underscore	enters underscore in text string

Character	Description	Function
⊠	'x' in box	deletes highlighted character in text string
⌋⌈	square brackets	inserts space between two characters in text string (limited to one space between characters)
↵	return arrow key	deletes characters (including currently highlighted character) to end of text string

2.14.1. Date

Date is the current date in the format: YYYY-MM-DD.

Values	Range: 1900-01-01 to 2155-12-31
---------------	---------------------------------

2.14.2. Time

Time is the current time in 24-hour format: HH:MM[:SS].

Values	Range: 00:00:00 to 23:59:59
---------------	-----------------------------

A value for seconds [:SS] is optional. If a value is not entered, the clock will default to 0 seconds.

2.14.3. Daylight Saving

Use the following parameters to enable and define start/end dates for daylight saving. (Start/end time of day is always 2:00am.)

Example:

Set the start of daylight saving to the second Sunday in February, and the end of daylight saving to the first Sunday in November:

- Starting Ordinal = Second
- Starting Day = Sunday
- Starting Month = February
- Ending Ordinal = First
- Ending Day = Sunday
- Ending Month = November

2.14.3.1. Enable

Enables/disables daylight saving.

Options		ENABLED
	*	DISABLED

2.14.3.2. Starting Ordinal

The order of the day within the month when daylight saving will begin.

Options		FIRST, SECOND, THIRD, FOURTH
	*	FIRST

2.14.3.3. Starting Day

The day of the week on which daylight saving will begin.

Options		SUNDAY, MONDAY, TUESDAY, WEDNESDAY, THURSDAY, FRIDAY, SATURDAY
	*	SUNDAY

2.14.3.4. Starting Month

The month in which daylight saving will begin.

Options		JANUARY, FEBRUARY, MARCH, APRIL, MAY, JUNE, JULY, AUGUST, SEPTEMBER, OCTOBER, NOVEMBER, DECEMBER
	*	JANUARY

2.14.3.5. Ending Ordinal

The order of the day within the month when daylight saving will end.

Options		FIRST, SECOND, THIRD, FOURTH
	*	FIRST

2.14.3.6. Ending Day

The day of the week on which daylight saving will end.

Options		SUNDAY, MONDAY, TUESDAY, WEDNESDAY, THURSDAY, FRIDAY, SATURDAY
	*	SUNDAY

2.14.3.7. Ending Month

The month in which daylight saving will end.

Options		JANUARY, FEBRUARY, MARCH, APRIL, MAY, JUNE, JULY, AUGUST, SEPTEMBER, OCTOBER, NOVEMBER, DECEMBER
	*	JANUARY

2.15. Flow

Available only on LUT430 (Pump and Flow model) and LUT440 (OCM model).

Note: Default settings in the parameter tables are indicated with an asterisk (*) unless explicitly stated.

2.15.1. Primary Measuring Device (PMD)

The type of primary measuring device (PMD) used.

Values	*	OFF (no calculation)
		EXPONENTIAL DEVICES
		RECTANGULAR FLUME BS-3680
		ROUND NOSE HORIZONTAL CR. BS-3680
		TRAPEZOIDAL FLUME BS-3680
		U-FLUME BS-3680
		FINITE CREST WEIR BS-3680
		THIN PLATE RECT. WEIR BS-3680
		THIN PLATE V-NOTCH WEIR BS-3680
		RECT. WEIR CONTRACTED
		ROUND PIPE
		PALMER BOWLUS FLUME
		H-FLUME
		UNIVERSAL HEAD FLOW

The LUT400 is pre-programmed for common PMD flow calculations. If your PMD is not listed, use a Universal Flow calculation. See **Universal calculation support** on page 116.

2.15.2. Auto Zero Head

Calibrates 2.15.3.5.Zero Head Offset (defined in 2.1.1.Units) based on actual head measurements.

Values	Range: -60.000 to 60.000
	Default: 0.000

Use this parameter when the reported head is consistently high or low by a fixed amount.

Before using this feature, verify the following parameters are correct:

- *2.2.1.Low Calibration Point*
- *2.12.1.2.Process Temperature*

With HEAD steady...

- a) Measure the actual head (e.g. with a tape measure or solid rule)
- b) Enter the actual head value

The deviation between the entered head value and the calibrated value, is stored in *2.15.3.5.Zero Head Offset*.

2.15.3. Basic Setup

2.15.3.1. Method of Flow Calculation

Sets the method of flow calculation.

Options	*	ABSOLUTE
		RATIOMETRIC

Set this parameter to **Ratiometric** only if the primary measuring device (PMD) supports ratiometric calculations. (Note that Palmer Bowlus Flume and H-Flume support ratiometric calculations only.) For more details on Absolute and Ratiometric calculations, see **Method of Flow Calculation** on page 266.

2.15.3.2. Flow Exponent

The exponent for the flow calculation formula.

Values	Range: -999.000 to 9999.000
	Default: 1.550

Use this parameter if the PMD is set to **Exponential devices**. It creates an exponential curve with end points set by *2.15.3.3.Maximum Head* and *2.15.3.5.Zero Head Offset* and with the curve based on the specified exponent.

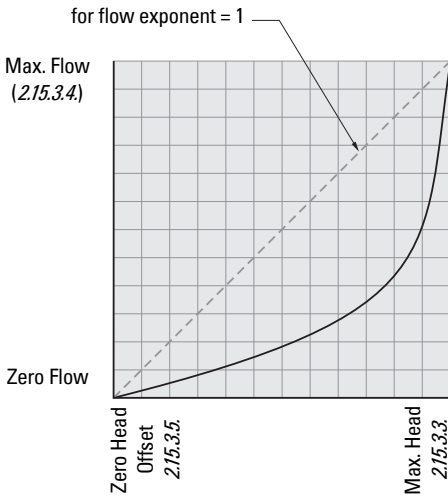

Exponents

The exponential equation is:

$$Q = KH^{\text{Flow Exponent (2.15.3.2)}}$$

Where:

Q = flow

K = constant factor

H = head

Use the exponent specified by the PMD manufacturer, if available, or relevant Open Channel Monitoring reference material.

2.15.3.3. Maximum Head

The maximum level value associated with the PMD and works in conjunction with 2.15.3.4. Maximum Flow at 20 mA for Ratiometric calculations. (Defined in 2.1.1.Units.)

Values	Range: 0.000 to 60.000
	Default: 60.000

This represents the highest head level supported by the Primary Measuring Device (PMD) and works in conjunction with 2.15.3.4. Maximum Flow at 20 mA to define the highest point in the exponential curve. Use it when the PMD requires a maximum head and flow reference point. Maximum Head must be set for all Absolute and Ratiometric PMDs.

2.15.3.4. Maximum Flow at 20 mA

The maximum flowrate associated with 2.15.3.3. Maximum Head shown in 2.15.3.7. Flowrate Units.

Values	Range: 0 to 9999999
	Default: 100

This represents the flow at the highest head level supported by the Primary Measuring Device (PMD) and works in conjunction with 2.15.3.3. Maximum Head to define the highest point in the exponential curve. Use it when the PMD requires a maximum head and flow reference point. Maximum Flow must be set for all Absolute and Ratiometric PMDs.

2.15.3.5. Zero Head Offset

The difference (positive or negative) between Low Calibration Point and zero head (level at zero flow), defined in 2.1.1.Units.

Values	Range: -60.000 to 60.000
	Default: 0.000

This feature can be used for most weirs and some flumes (e.g. Palmer Bowlus) where the zero reference is at a higher elevation than the channel bottom.

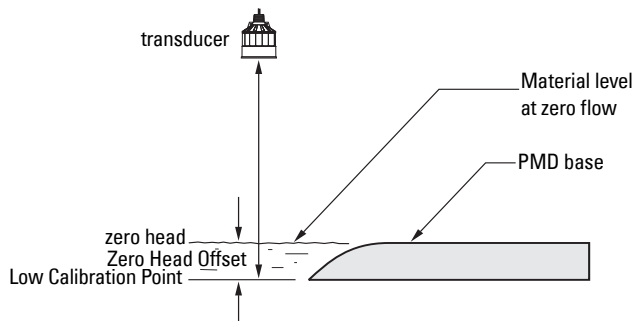

2.15.3.6. Flowrate Decimal

The maximum number of decimal places to be displayed.

Options	*	NO DIGITS	no digits after the decimal point
		1 DIGIT	1 digit after the decimal point
		2 DIGITS	2 digits after the decimal point
		3 DIGITS	3 digits after the decimal point

2.15.3.7. Flowrate Units

The volume units used to display total flow.

Options	*	L/S (Litres per second)
		L/MIN (Litres per minute)
		CUFT/S (Cubic feet per second)
		CUFT/D (Cubic feet per day)
		GAL/MIN (US Gallons per minute)
		GAL/D (US Gallons per day)
		IMPGAL/MIN (Imperial Gallons per minute)
		IMPGAL/D (Imperial Gallons per day)
		CUM/H (Cubic meters per hour)
		CUM/D (Cubic meters per day)
		USER DEFINED (units defined in 2.15.3.8. User Defined Unit)

2.15.3.8. User Defined Unit

*Set the unit text to display for current flow when 2.15.3.7. Flowrate Units set to **user-defined**. Limited to 16 ASCII characters.*

Notes: The text entered is simply for display purposes. No unit conversion occurs.

2.15.3.9. Low Flow Cutoff

Eliminates totalizer activity for head levels at or below the cutoff value.

Values	Range: 0.000 to 60.000
	Default: 0.000

Enter the minimum head in 2.11.Units where totalizer activity should cease.

2.15.4. PMD Dimensions

The dimensions of the Primary Measuring Device (PMD). (The dimensions of the vessel, wet well, or reservoir are only important if you require volume.)

The following table is a reference to the parameters that must be set for each PMD. Parameter definitions follow the table.

Supported PMD	Dimensions required
Exponential Devices	
	<i>2.15.3.2. Flow Exponent</i>
	<i>2.15.4.1. K Factor</i>
Rectangular Flume BS-3680	
	<i>2.15.4.5. OCM Dimension 1 - approach width B</i>
	<i>2.15.4.6. OCM Dimension 2 - throat width b</i>
	<i>2.15.4.7. OCM Dimension 3 - hump height p</i>
	<i>2.15.4.8. OCM Dimension 4 - throat length L</i>
Round Nose Horizontal Crest Weir BS-3680	
	<i>2.15.4.5. OCM Dimension 1 - crest width b</i>
	<i>2.15.4.6. OCM Dimension 2 - crest height p</i>
	<i>2.15.4.7. OCM Dimension 3 - crest length L</i>
Trapezoidal Flume BS-3680	
	<i>2.15.4.5. OCM Dimension 1 - approach width B</i>
	<i>2.15.4.6. OCM Dimension 2 - throat width b</i>
	<i>2.15.4.7. OCM Dimension 3 - hump height p</i>
	<i>2.15.4.8. OCM Dimension 4 - throat length L</i>
	<i>2.15.4.3. Slope</i>
U-Flume BS-3680	
	<i>2.15.4.5. OCM Dimension 1 - approach diameter Da</i>
	<i>2.15.4.6. OCM Dimension 2 - throat diameter D</i>
	<i>2.15.4.7. OCM Dimension 3 - hump height p</i>
	<i>2.15.4.8. OCM Dimension 4 - throat length L</i>
Finite Crest Weir BS-3680	
	<i>2.15.4.5. OCM Dimension 1 - crest width b</i>
	<i>2.15.4.6. OCM Dimension 2 - crest height p</i>
	<i>2.15.4.7. OCM Dimension 3 - crest length L</i>

Supported PMDs (cont'd)	
Thin Plate Rectangular Weir BS-3680	
	2.15.4.5. <i>OCM Dimension 1</i> - approach width B
	2.15.4.6. <i>OCM Dimension 2</i> - crest width b
	2.15.4.7. <i>OCM Dimension 3</i> - crest height p
Thin Plate V-Notch Weir BS-3680	
	2.15.4.2. <i>V-Notch Angle</i>
Rectangular Weir Contracted	
	2.15.4.5. <i>OCM Dimension 1</i> - crest width b
Round Pipe	
	2.15.4.5. <i>OCM Dimension 1</i> - pipe inside diameter D
	2.15.4.3. <i>Slope</i>
	2.15.4.4. <i>Roughness Coefficient</i>
Palmer Bowlus Flume	
	2.15.4.5. <i>OCM Dimension 1</i> - maximum flume width hmax
H-Flume	
	2.15.4.5. <i>OCM Dimension 1</i> - maximum listed head hmax
Universal Head Flow	
	2.15.5.1.1. <i>Head 1</i> (up to 32)
	2.15.5.1.2. <i>Flow 1</i> (up to 32)

2.15.4.1. K Factor

The constant used in the flow calculation formula for absolute calculation of an exponential device only.

Values
Range: -999.000 to 9999.000
Default: 1.000

Use this parameter if the PMD is set to **Exponential devices**. The Constant Factor is used to create an exponential curve with end points set by 2.15.3.3. *Maximum Head* and 2.15.3.5. *Zero Head Offset*, and with the curve based on the specified exponent.

2.15.4.2. V-Notch Angle

The V-Notch angle used in the flow calculation formula.

Values	Range: 25.000 to 95.000
	Default: 25.000

Use when PMD is set to Thin Plate V-Notch Weir.

2.15.4.3. Slope

The Flow Slope used in the flow calculation formula.

Values	Range: -999.000 to 9999.000
	Default: 0.000

Use when PMD is set to Trapezoidal Flume or Round Pipe.

2.15.4.4. Roughness Coefficient

The Flow Roughness Coefficient used in the flow calculation formula.

Values	Range: -999.000 to 9999.000
	Default: 0.000

Use when PMD is set to Round Pipe.

2.15.4.5. OCM Dimension 1

2.15.4.6. OCM Dimension 2

2.15.4.7. OCM Dimension 3

2.15.4.8. OCM Dimension 4

See table under **PMD Dimensions (2.15.4.)** to relate OCM Dimension 1-4 above to a specific dimension for each directly supported Primary Measuring Device. For PMDs that are not directly supported (*Universal Head Flow*), use a Universal Flow calculation. See **Universal calculation support** on page 116.

For more information on PMD, see **Open Channel Monitoring (OCM)** on page 97.

2.15.5. Universal Head vs. Flow

In the following table, enter Head and Flow Breakpoints for universal PMDs.

*Head Breakpoints: The head breakpoints for which flowrate is known, defined in **Units (2.1.1.)**.*

*Flowrate Breakpoints: The flowrate corresponding to each Head Breakpoint entered, defined in **Flowrate Units (2.15.3.7.)**.*

Head Values	Range: 0.000 to 60.000
	Default: 0.000
Flowrate Values	Range: 0 to 9999999
	Default: 0

See **Universal calculation support** on page 116 for details on how to specify universal flows.

Entering breakpoints via SIMATIC PDM:

See *Quick Start (Flow)* in the LUT400 Communications manual¹.

2.15.5.1. Table 1-8

2.15.5.1.1. Head 1

2.15.5.1.2. Flow 1

2.15.5.2. Table 9-16

2.15.5.2.1. Head 9

2.15.5.2.2. Flow 9

2.15.5.3. Table 17-24

2.15.5.3.1. Head 17

2.15.5.3.2. Flow 17

2.15.5.4. Table 25-32

2.15.5.4.1. Head 25

2.15.5.4.2. Flow 25

2.16. Totalizers

Available only on LUT430 (Pump and Flow model) and LUT440 (OCM model).

Note: Default settings in the parameter tables are indicated with an asterisk (*) unless explicitly stated.

2.16.1. Daily Totalizer

Read only. Current daily totalizer value. (Automatically resets daily and can be reset by user.)

Values	Range: 0.00 to 999999999
	Default: 0.00

2.16.2. Running Totalizer

Read only. Current running totalizer value. (Reset only by user.)

Values	Range: 0.00 to 999999999
	Default: 0.00

2.16.3. Totalizer Decimal Position

Sets the maximum number of decimal places to be displayed.

Options		NO DIGITS	no digits after the decimal point
		1 DIGIT	1 digit after the decimal point
	*	2 DIGITS	2 digits after the decimal point
		3 DIGITS	3 digits after the decimal point

¹ Communications for SITRANS LUT400 (HART) Manual (7ML19985NE01)

2.16.4. Totalizer Multiplier

Use this feature if the LCD Total increments by an amount that is too large (or too small).

Options		.001
		.01
		.1
	*	1
		10
		100
		1000
		10,000
		100,000
		1,000,000
		10,000,000

Enter the factor (powers of 10 only) by which actual flow is divided, prior to display on LCD. Use a value such that the eight-digit totalizer doesn't roll over between readings.

Example: For an LCD Total display in 1000s of flow units, enter 1000.

2.16.5. Reset Daily Totalizer

Select **YES** to reset daily totalizer value to zero.

Options	*	NO
		YES

2.16.6. Reset Running Totalizer

Select **YES** to reset running totalizer value to zero.

Options	*	NO
		YES

3. Maintenance and Diagnostics

Note: Default settings in the parameter tables are indicated with an asterisk (*) unless explicitly stated.

3.1. Identification

To edit parameters with a string editor (3.1.1 to 3.1.5), see **Using the string editor:** on page 187.

3.1.1. TAG

*Text that can be used in any way. A recommended use is as a unique label for a field device in a plant. Limited to 32 alphanumeric characters (8 characters via HART). Appears in top left corner of display in measurement mode (see **The LCD Display** on page 34).*

3.1.2. Long TAG

Text that can be used in any way. A recommended use is as a unique label for a field device in a plant. Limited to 32 alphanumeric characters.

3.1.3. Descriptor

Text that can be used in any way. Limited to 32 ASCII characters (16 ASCII characters via HART). No specific recommended use.

3.1.4. Message

Text that can be used in any way. Limited to 32 ASCII characters. No specific recommended use.

3.1.5. Installation Date

Date the device was first commissioned (YYYY-MM-DD).

Manufacturer

Read only. The device manufacturer (e.g. Siemens).

Product Name

Read only. Identifies the product by name (e.g. SITRANS LUT400).

3.1.6. Product

Read only. Identifies the product by name and capability:

SITRANS LUT420 (Level)

SITRANS LUT430 (Pump and Flow)

SITRANS LUT440 (OCM)

3.1.7. Order No. (Order Number in PDM)

Read only. Order number for the current device configuration (e.g. 7ML5050-OCA10-1DA0).

3.1.8. Serial Number

Read only. Unique factory set serial number of the device.

3.1.9. Final Assembly Number

Integer used to identify the device on site, e.g. enter '2' to denote second SITRANS LUT400 in application.

3.1.10. Hardware Revision

Read only. Corresponds to the electronics hardware of the Field Device.

3.1.11. Firmware Revision

Read only. Corresponds to the software or firmware that is embedded in the Field Device.

3.1.12. Loader Revision

Read only. Corresponds to the software used to update the Field Device.

EDD Version

Read only. Corresponds to the Electronics Device Description (EDD) installed with the device.

3.1.13. Manufacture Date (Date of Manufacturing in PDM)

The date of manufacture of the SITRANS LUT400 (YYYY-MM-DD).

3.1.14. Order Option

Read only. Displays the device type: Standard or NAMUR 43-compliant.

3.2. Diagnostics

Note: Default settings in the parameter tables are indicated with an asterisk (*) unless explicitly stated.

3.2.1. Echo Profile

Allows you to request the current echo profile either locally via the local push buttons, or remotely via SIMATIC PDM.

To request a profile via the local push buttons:

- a) In PROGRAM mode, navigate to **MAIN MENU > DIAGNOSTICS (3) > ECHO PROFILE (3.1)**
- b) Press **RIGHT arrow** to request a profile.

Note: An Echo Profile (3.2.1.) cannot be requested from LUI when:

- **Transducer Enable (3.3.1.)** is set to DISABLED, or when
- **Transducer (2.1.6.)** is set to NO TRANSDUCER.
In either case, the local push button will not operate.

For more detail see **Requesting an Echo Profile** on page 57.

For more details on how to interpret an Echo Profile, see **Echo Processing** on page 255.

To request a profile via SIMATIC PDM:

- a) Open the menu **Device – Echo Profile Utilities**. (For more details see *Echo Profile Utilities* in LUT400 Communications manual.¹)

3.2.2. Trend

*Read only. Display of level trends. Captures last 3000 PV values (logged at five minute intervals) in percentage of range (defined in 2.1.1.Units). For more information, see **Trends** on page 118.*

3.2.3. Master Reset

Note: Following a reset to **Factory Defaults**, complete reprogramming is required.

Resets all parameter to factory defaults, with the following exceptions:

- Tag, Long Tag, Description, Message, Assembly Number
- **Device Address (4.1.)** and **Language (6.)** remain unchanged
- **Write Protection (5.1.)** value is not reset
- **Auto False Echo Suppression (2.12.3.1.)** learned TVT is not lost
- **Shaper Mode (2.12.3.4.)**, and breakpoints for **TVT Shaper (2.12.4.)** are not lost
- **Totalizers (2.7.3.)** values are not reset

¹ Communications for SITRANS LUT400 (HART) Manual (7ML19985NE01)

- **Date (2.14.1.)** and **Time (2.14.2.)** values are not reset

Options	*	DO NOTHING (Return to previous menu)
		FACTORY DEFAULTS

To perform a reset to factory defaults via SIMATIC PDM, open the menu **Device – Master Reset**.

3.2.4. Power-on Resets

The number of power cycles that have occurred since manufacture.

In SIMATIC PDM, open the menu **Device – Wear**.

3.2.5. Power-on Time

Displays the number of days the device has been powered on since manufacture.

In SIMATIC PDM, open the menu **Device – Wear**.

3.2.6. View Logs

*View various log types with entries (to a collective maximum of approximately 30,000) listed by day. For a list of field names that coincide with the comma delimited log file on the PC, see **Data Logging** on page 267.*

Notes:

- No data logs are written while device is connected to a PC via USB.
- To clear entries when log memory becomes full, see **Viewing the Data Log** on page 119.

3.2.6.1. Alarms

History of alarms. Displays type of alarm, value at which alarm triggered, state of alarm.

3.2.6.2. OCM

Flow logs. Displays head and flow values.

3.2.6.3. Daily Totals

Daily totals for both totalizers. Displays maximum and minimum values for flow and temperature, average flow, and daily totalizer (DT) and running totalizer (RT) values.

3.2.6.4. PV

Primary Variable. Displays PV type (e.g. Level), PV value and temperature.

Note: PV is controlled by the mA function (see 2.5.1. *Current Output Function*). Therefore, the LUI operation can be changed (via 2.1.2. *Sensor Mode*) without affecting the process being controlled.

3.2.7. Pump Records

Relay usage.

3.2.7.1. Run Time Relay 2

Read or set the total running time of Relay 2 in hours.

Values	Range: 0 to 999999
--------	--------------------

3.2.7.2. Run Time Relay 3

Read or set the total running time of Relay 3 in hours.

Values	Range: 0 to 999999
--------	--------------------

3.2.7.3. Relay Pump 1

Read only. Relay assigned to Pump 1.

To change the relay assignment, see 2.71.2. *Relay Pump 1.*

3.2.7.4. Relay Pump 2

Read only. Relay assigned to Pump 2.

To change the relay assignment, see 2.71.3. *Relay Pump 2.*

3.2.8. Temperature Peak Values

This feature displays the high and low process temperatures in °C.

If the device is powered up without a temperature sensor connected, the default fixed temperature value 20 °C is displayed [see **Fixed Temperature (2.12.1.4.)**]. This information can help trace problems with both built in and external temperature sensors.

3.2.8.1. Highest Value

View the highest process temperature encountered, as measured by the transducer in °C.

3.2.8.2. Lowest Value

View the lowest process temperature encountered, as measured by the transducer in °C.

3.2.9. Echo Quality

3.2.9.1. Figure of Merit

*This value measures the quality of the reported echo value: higher values represent better quality. This measure combines the noise level, quality of tracking, and signal strength. (For more details see **Echo Processing** on page 255.)*

Values (view only)	Range: 0 to 100 %
--------------------	-------------------

3.2.9.2. Confidence

*Indicates echo reliability: higher values represent better echo quality. The display shows the echo confidence of the last measurement. **Echo Threshold (2.12.2.2.)** defines the minimum criterion for echo confidence.*

Values (view only)	Range: -20 to 128
--------------------	-------------------

In SIMATIC PDM, open the menu **Device – Echo Profile Utilities** and click on the tab **Echo Profile**.

3.2.9.3. Echo Strength

Displays the absolute strength (in dB above 1 μ V rms) of the echo selected as the measurement echo.

Values (view only)	Range: -20 to 128 dB
---------------------------	----------------------

In SIMATIC PDM, open the menu **Device – Echo Profile Utilities** and click on the tab **Echo Profile**.

3.2.9.4. Noise Average

Displays the average ambient noise (in dB above 1 μ V rms) of a noise profile after each measurement.

The noise level is a combination of transient acoustic noise and electrical noise (induced into the transducer cable or receiving circuitry). See **Noise Problems** on page 240.

3.2.9.5. Noise Peak

Displays the peak ambient noise (in dB above 1 μ V rms) of a noise profile after each measurement.

3.3. Maintenance

Note: Default settings in the parameter tables are indicated with an asterisk (*) unless explicitly stated.

3.3.1. Transducer Enable

Enables/disables transducer from taking measurements.

Options	*	ENABLED
		DISABLED

Set parameter to Disabled to stop transducer from measuring while calibration or maintenance work is performed. Set to Enabled to restart measurements after calibration or maintenance complete.

Notes:

- An **Echo Profile (3.2.1.)** cannot be requested from LUI when **Transducer Enable (3.3.1.)** is set to DISABLED. The local push button will not operate.
- When **Transducer Enable (3.3.1.)** is set to DISABLED, the LOE fault will display immediately.
- If **Transducer Enable (3.3.1.)** is set to DISABLED and power to the device is turned off, **Transducer Enable (3.3.1.)** will be reset to ENABLED when power is restored.

3.3.2. Backup Control

LUI only. Determine source of configuration recovery file when sensor has been replaced.

Options	*	DONE	No change required (no fault displayed), or operation is complete
		FROM SENSOR	Sensor parameters will be used as is, and LUI will receive these parameters as backup.
		FROM LUI	Recovery of sensor parameters will come from LUI backup.

When sensor unit has been replaced, fault code 132 is displayed to note that LUI backup file does not match configuration file in sensor. To clear fault, set Backup Control option to location from where parameter configuration should be read; from the LUI backup file or from the new sensor.

3.3.3. Remaining Device Life

Notes:

- Four sets of parameters allow you to monitor the Device/Sensor Lifetimes and set up Maintenance/Service schedules, based on operating hours instead of a calendar-based schedule. See also **Remaining Sensor Life (3.3.4.)**, **Service Schedule (3.3.5.)**, and **Calibration Schedule (3.3.6.)**.
- Performing a reset to **Factory Defaults** will reset all the Maintenance Schedule parameters to their factory defaults.
- The device operates in years. To view Remaining Device Lifetime parameters in hours or days (only via SIMATIC PDM, PACTware FDT, and AMS) see **Lifetime Expected (3.3.3.1.)**.

The device tracks itself based on operating hours and monitors its predicted lifetime. You can modify the expected device lifetime, set up schedules for maintenance reminders, and acknowledge them.

The maintenance warnings and reminders are available through HART communications. This information can be integrated into an Asset Management system. For optimal use, we recommend that you use SIMATIC PCS7 Asset Management Software in conjunction with SIMATIC PDM.

To access these parameters via SIMATIC PDM:

- Open the menu **Device – Maintenance** and select the **Remaining Device Lifetime** tab. (For more details see *Maintenance* in LUT400 Communications manual.¹)

¹ Communications for SITRANS LUT400 (HART) Manual (7ML19985NE01)

Time Units

Allows you to set the desired units.

Options ^a	HOURS
	DAYS
	* YEARS

^a. Units are selectable only via SIMATIC PDM, PACTware FDT, and AMS.

3.3.3.1. Lifetime Expected

Note: The device always operates in years. Changing the Time Units affects only the parameter view of the Remaining Device Lifetime parameters in SIMATIC PDM, PACTware FDT, and AMS.

Allows you to override the factory default.

Values	Units ^a : hours, days, years
	Range: 0.000 to 20.000 years
	Default: 10.000 years

^a. Units are selectable only via SIMATIC PDM, PACTware FDT, and AMS.

3.3.3.2. Time in Operation

Read only. The amount of time the device has been operating.

3.3.3.3. Remaining Lifetime

Read only. **Lifetime Expected (3.3.3.1.)** less **Time in Operation (3.3.3.2.)**.

3.3.3.4. Reminder Activation

Note: To modify this parameter via SIMATIC PDM it must be accessed via the pull-down menu **Device – Maintenance**.

Allows you to enable a maintenance reminder.

Options	REMINDER 1 (MAINTENANCE REQUIRED)
	REMINDER 2 (MAINTENANCE DEMANDED)
	REMINDERS 1 AND 2
	* OFF

- First set the values in **Reminder 1 before Lifetime (Required) (3.3.3.5.)**/**Reminder 2 before Lifetime (Demanded) (3.3.3.6.)**.
- Select the desired **Reminder Activation** option.

3.3.3.5. Reminder 1 before Lifetime (Required)

If **Remaining Lifetime (3.3.3.3.)** is equal to or less than this value, the device generates a **Maintenance Required** reminder.

Values	Range: 0.000 to 20.000 years
	Default: 0.164 years (8 weeks)

- Modify values as required.
- Set **Reminder Activation (3.3.3.4.)** to the desired option.

3.3.3.6. Reminder 2 before Lifetime (Demanded)

If **Remaining Lifetime (3.3.3.3)** is equal to or less than this value, the device generates a **Maintenance Demanded** reminder.

Values	Range: 0.000 to 20.000 years
	Default: 0.019 years (1 week)

- Modify values as required.
- Set **Reminder Activation (3.3.3.4.)** to the desired option.

3.3.3.7. Maintenance Status

Indicates which level of maintenance reminder is active.

In SIMATIC PDM, open the menu **View – Device Status**, click on the **Maintenance** tab, and check the **Device Lifetime Status** window.

3.3.3.8. Acknowledged Status

Indicates which level of maintenance reminder has been acknowledged.

In SIMATIC PDM, open the menu **View – Device Status**, click on the **Maintenance** tab, and check the **Device Lifetime Status** window.

3.3.3.9. Acknowledged

Acknowledges the current maintenance reminder.

To acknowledge a reminder via SIMATIC PDM:

- Open the menu **View – Device Status** and click on the tab **Maintenance**.
- In the **Device Lifetime** section, click on **Acknowledge Warnings**.

To acknowledge a reminder via the local push buttons:

- Navigate to **Maintenance and Diagnostics (3.) > Maintenance (3.3.) > Remaining Device Life (3.3.3.) > Acknowledged (3.3.3.9.)**, and **RIGHT arrow ►** to acknowledge the reminder.

3.3.4. Remaining Sensor Life

Notes:

- Four sets of parameters allow you to monitor the Device/Sensor Lifetimes and set up Maintenance/Service schedules, based on operating hours instead of a calendar-based schedule. See also **Remaining Device Life (3.3.3.)**, **Service Schedule (3.3.5.)**, and **Calibration Schedule (3.3.6.)**.
- Performing a reset to **Factory Defaults** will reset all the Maintenance Schedule parameters to their factory defaults.
- The device operates in years. To view Remaining Sensor Lifetime parameters in hours or days (only via SIMATIC PDM, PACTware FDT, and AMS) see **Lifetime Expected (3.3.4.1.)**.

The device monitors the predicted lifetime of the sensor (the components exposed to the vessel environment). You can modify the expected sensor lifetime, set up schedules for maintenance reminders, and acknowledge them.

To access these parameters via SIMATIC PDM:

- Open the menu **Device – Maintenance** and select the **Remaining Sensor Lifetime** tab. (For more details see *Maintenance* in LUT400 Communications manual.¹)

Time Units

Allows you to set the desired units.

Options^a		HOURS
		DAYS
	*	YEARS

^a. Units are selectable only via SIMATIC PDM, PACTware FDT, and AMS.

3.3.4.1. Lifetime Expected

Note: The device always operates in years. Changing the Time Units affects only the parameter view of Remaining Sensor Life parameters in SIMATIC PDM, PACTware FDT, and AMS.

Allows you to override the factory default.

Values	Units ^a : hours, days, years
	Range: 0.000 to 20.000 years
	Default: 10.000 years

^a. Units are selectable only via SIMATIC PDM, PACTware FDT, and AMS.

3.3.4.2. Time in Operation

The amount of time the sensor has been operating. Can be reset to zero after performing a service or replacing the sensor.

To reset to zero:

- In SIMATIC PDM, open the menu **Device – Maintenance**, click on the **Remaining Sensor Lifetime** tab, and click on **Sensor Replaced** to re-start the timer and clear any fault messages.
- Via the local push buttons, navigate to **Maintenance and Diagnostics (3.) > Maintenance (3.3.) > Remaining Sensor Life (3.3.4.) > Time in Operation (3.3.4.2.)**, and set to zero.

3.3.4.3. Remaining Lifetime

*Read only. **Lifetime Expected (3.3.4.1.)** less **Time in Operation (3.3.4.2.)***

¹. Communications for SITRANS LUT400 (HART) Manual (7ML19985NE01)

3.3.4.4. Reminder Activation

Note: To modify this parameter via SIMATIC PDM it must be accessed via the pull-down menu **Device – Maintenance**.

Allows you to enable a maintenance reminder.

Options	REMINDER 1 (MAINTENANCE REQUIRED)
	REMINDER 2 (MAINTENANCE DEMANDED)
	REMINDERS 1 AND 2
	* OFF

- First set the values in **Reminder 1 before Lifetime (Required) (3.3.4.5.)/Reminder 2 before Lifetime (Demanded) (3.3.4.6.)**.
- Select the desired Reminder Activation option.

3.3.4.5. Reminder 1 before Lifetime (Required)

*If **Remaining Lifetime (3.3.4.3.)** is equal to or less than this value, the device generates a **Maintenance Required** reminder.*

Values	Range: 0.000 to 20.000 years
	Default: 0.164 years (8 weeks)

- Modify values as required.
- Set **Reminder Activation (3.3.4.4.)** to the desired option.

3.3.4.6. Reminder 2 before Lifetime (Demanded)

*If **Remaining Lifetime (3.3.4.3.)** is equal to or less than this value, the device generates a **Maintenance Demanded** reminder.*

Values	Range: 0.000 to 20.000 years
	Default: 0.019 years (1 week)

- Modify values as required.
- Set **Reminder Activation (3.3.4.4.)** to the desired option.

3.3.4.7. Maintenance Status

Indicates which level of maintenance reminder is active.

In SIMATIC PDM, open the menu **View – Device Status**, click on the **Maintenance** tab, and check the **Sensor Lifetime Status** window.

3.3.4.8. Acknowledged Status

Indicates which level of maintenance reminder has been acknowledged.

In SIMATIC PDM, open the menu **View – Device Status**, click on the **Maintenance** tab and check the **Sensor Lifetime Status** window.

3.3.4.9. Acknowledged

Acknowledges the current maintenance reminder.

To acknowledge a reminder via SIMATIC PDM:

- Open the menu **View – Device Status** and click on the **Maintenance** tab.
- In the **Sensor Lifetime** section click on **Acknowledge Warnings**.

To acknowledge a reminder via the local push buttons:

- a) Navigate to **Maintenance and Diagnostics (3.) > Maintenance (3.3.) > Remaining Sensor Life (3.3.4.) > Acknowledged (3.3.3.9.)**, and **RIGHT arrow ►** to acknowledge the reminder.

3.3.5. Service Schedule

Notes:

- Four sets of parameters allow you to monitor the Device/Sensor Lifetimes and set up Maintenance/Service schedules, based on operating hours instead of a calendar-based schedule. See also **Remaining Device Life (3.3.3.)**, **Remaining Sensor Life (3.3.4.)**, and **Calibration Schedule (3.3.6.)**.
- Performing a reset to **Factory Defaults** will reset all the Maintenance Schedule parameters to their factory defaults.
- The device operates in years. To view Service Interval parameters in hours or days (only via SIMATIC PDM, PACTware FDT, and AMS) see **Service Interval (3.3.5.1.)**.

The device tracks service intervals based on operating hours and monitors the predicted lifetime to the next service. You can modify the Total Service Interval, set schedules for maintenance reminders, and acknowledge them.

The maintenance warnings and reminders are communicated to the end user through status information. This information can be integrated into any Asset Management system. For optimal use, we recommend that you use SIMATIC PCS7 Asset Management Software in conjunction with SIMATIC PDM.

To access these parameters via SIMATIC PDM:

- Open the menu **Device – Maintenance** and select the **Service Schedule** tab. (For more details see *Maintenance* in LUT400 Communications manual.¹⁾)

Time Units

Allows you to set the desired units.

Options^a	HOURS
	DAYS
	* YEARS

- ^a Units are selectable only via SIMATIC PDM, PACTware FDT, and AMS.

¹ Communications for SITRANS LUT400 (HART) Manual (7ML19985NE01)

3.3.5.1. Service Interval

Note: The device always operates in years. Changing the Time Units affects only the parameter view of the Service Interval parameters in SIMATIC PDM, PACTware FDT, and AMS.

User-configurable recommended time between product inspections.

Values	Units ^a : hours, days, years
	Range: 0.000 to 20.000 years
	Default: 1.000 year

a. Units are selectable only via SIMATIC PDM, PACTware FDT, and AMS.

3.3.5.2. Time Last Service

Time elapsed since last service. Can be reset to zero after performing a service.

To reset to zero:

- In SIMATIC PDM, open the menu **Device – Maintenance**, click on the **Service Schedule** tab, and click on **Service Performed** to restart the timer and clear any fault messages.
- Navigate to **Maintenance and Diagnostics (3.) > Maintenance (3.3.) > Service Schedule (3.3.5.) > Time Last Service (3.3.5.2.)**, and set to zero.

3.3.5.3. Time Next Service

Read only. Time Next Service (3.3.5.3.) less Time Last Service (3.3.5.2.).

3.3.5.4. Reminder Activation

Note: To modify this parameter via SIMATIC PDM it must be accessed via the pull-down menu **Device – Maintenance**.

Allows you to enable a maintenance reminder.

Values	*	TIMER OFF
		ON NO LIMITS - no reminders checked
		ON REMINDER 1 (MAINTENANCE REQUIRED) checked
		ON REMINDER 1 AND 2 checked
		ON REMINDER 2 (MAINTENANCE DEMANDED) checked

- a) First set the values in **Reminder 1 before Service (Required) (3.3.5.5.)**/**Reminder 2 before Service (Demanded) (3.3.5.6.)**.
- b) Select the desired **Reminder Activation** option.

3.3.5.5. Reminder 1 before Service (Required)

*If Time Next Service (3.3.5.3.) is equal to or less than this value, the device generates a **Maintenance Required** reminder.*

Values	Range: 0.000 to 20.000 years
	Default: 0.164 years (8 weeks)

- a) Modify values as required.
- b) Set **Reminder Activation (3.3.5.4.)** to the desired option.

3.3.5.6. Reminder 2 before Service (Demanded)

If **Time Next Service (3.3.5.3.)** is equal to or less than this value, the device generates a **Maintenance Demanded** reminder.

Values	Range: 0.000 to 20.000 years
	Default: 0.019 years (1 week)

- Modify values as required.
- Set **Reminder Activation (3.3.5.4.)** to the desired option.

3.3.5.7. Maintenance Status

Indicates which level of maintenance reminder is active.

In PDM, open the menu **View – Device Status**, click on the **Maintenance** tab and check the **Service Schedule Status** window.

3.3.5.8. Acknowledged Status

Indicates which level of maintenance reminder has been acknowledged.

In PDM, open the menu **View – Device Status**, click on the **Maintenance** tab and check the **Service Schedule Status** window.

3.3.5.9. Acknowledged

Acknowledges the current maintenance reminder.

To acknowledge a reminder via SIMATIC PDM:

- Open the menu **View – Device Status** and click on the **Maintenance** tab.
- In the **Service Schedule Status** section click on **Acknowledge Warnings**.

To acknowledge a reminder via the local push buttons:

Navigate to **Maintenance and Diagnostics (3.) > Maintenance (3.3.) >**

Service Schedule (3.3.5.) > Acknowledged (3.3.5.9.), and **RIGHT arrow ►** to acknowledge the reminder.

3.3.6. Calibration Schedule

Notes:

- Four sets of parameters allow you to monitor the Device/Sensor Lifetimes and set up Maintenance/Service schedules, based on operating hours instead of a calendar-based schedule. See also **Remaining Device Life (3.3.3.)**, **Remaining Sensor Life (3.3.4.)**, and **Service Schedule (3.3.5.)**.
- Performing a reset to **Factory Defaults** will reset all the Maintenance Schedule parameters to their factory defaults.
- The device operates in years. To view Calibration Interval parameters in hours or days (only via SIMATIC PDM, PACTware FDT, and AMS) see **Calibration Interval (3.3.6.1.)**.

The device tracks calibration intervals based on operating hours and monitors the predicted lifetime to the next calibration. You can modify the Total Calibration Interval, set schedules for maintenance reminders, and acknowledge them.

To access these parameters via SIMATIC PDM:

- Open the menu **Device – Maintenance** and select the **Calibration Schedule** tab. (For more details see *Maintenance* in LUT400 Communications manual.¹)

Time Units

Allows you to set the desired units.

Options^a		HOURS
		DAYS
	*	YEARS

- ^a. Units are selectable only via SIMATIC PDM, PACTware FDT, and AMS.

3.3.6.1. Calibration Interval

Note: The device always operates in years. Changing the units affects only the parameter view of the Calibration Interval parameters in SIMATIC PDM, PACTware FDT, and AMS.

User-configurable recommended time between product calibrations.

Values	Units ^a : hours, days, years
	Range: 0.000 to 20.000 years
	Default: 1.000 year

- ^a. Units are selectable only via SIMATIC PDM, PACTware FDT, and AMS.

3.3.6.2. Time Last Calibration

Time elapsed since last calibration. Can be reset to zero after performing a calibration.

To reset to zero:

- In SIMATIC PDM, open the menu **Device – Maintenance**, click on the **Calibration Schedule** tab, and click on **Calibration Performed** to re-start the timer and clear any fault messages.
- Via the local push buttons, navigate to **Maintenance and Diagnostics (3.) > Maintenance (3.3.) > Calibration Schedule (3.3.6.) > Time Last Calibration (3.3.6.2.)**, and **set** to zero.

3.3.6.3. Time Next Calibration

*Read only. **Calibration Interval (3.3.6.1.)** less **Time Last Calibration (3.3.6.2.)***

¹. Communications for SITRANS LUT400 (HART) Manual (7ML19985NE01)

3.3.6.4. Reminder Activation

Note: To modify this parameter via SIMATIC PDM it must be accessed via the pull-down menu **Device – Maintenance**.

Allows you to enable a maintenance reminder.

Values	*	TIMER OFF
		ON NO LIMITS - no reminders checked
		ON REMINDER 1 (MAINTENANCE REQUIRED) checked
		ON REMINDER 1 AND 2 checked
		ON REMINDER 2 (MAINTENANCE DEMANDED) checked

- First set the values in **Reminder 1 before Calibration (Required) (3.3.6.5.)/Reminder 2 before Calibration (Demanded) (3.3.6.6.)**.
- Select the desired **Reminder Activation** option.

3.3.6.5. Reminder 1 before Calibration (Required)

*If **Time Next Calibration (3.3.6.3.)** is equal to or less than this value, the device generates a **Maintenance Required** reminder.*

Values	Range: 0.000 to 20.000 years
	Default: 0.164 years (8 weeks)

- Modify values as required.
- Set **Reminder Activation (3.3.6.4.)** to the desired option.

3.3.6.6. Reminder 2 before Calibration (Demanded)

*If **Time Next Calibration (3.3.6.3.)** is equal to or less than this value, the device generates a **Maintenance Demanded** reminder.*

Values	Range: 0.000 to 20.000 years
	Default: 0.019 years (1 week)

- Modify values as required.
- Set **Reminder Activation (3.3.6.4.)** to the desired option.

3.3.6.7. Maintenance Status

Indicates which level of maintenance reminder is active.

In SIMATIC PDM, open the menu **View – Device Status**, click on the **Maintenance** tab and check the **Calibration Schedule Status** window.

3.3.6.8. Acknowledged Status

Indicates which level of maintenance reminder has been acknowledged.

In SIMATIC PDM, open the menu **View – Device Status**, click on the **Maintenance** tab and check the **Calibration Schedule Status** window.

3.3.6.9. Acknowledged

Acknowledges the current maintenance reminder.

To acknowledge a reminder via SIMATIC PDM:

- Open the menu **View – Device Status** and click on the **Maintenance** tab.
- In the **Calibration Schedule Status** section click on **Acknowledge Warnings**.

To acknowledge a reminder via the local push buttons:

Navigate to **Maintenance and Diagnostics (3.) > Maintenance (3.3.) > Calibration Schedule (3.3.6.) > Acknowledged (3.3.6.9.)**, and **RIGHT** arrow

▶ to acknowledge the reminder.

3.4. Simulation

Use simulation to test your application. For further details, see **Application examples** on page 58.

3.4.1. Level

Simulates level changes, and activates relays based on the setpoints programmed.

3.4.1.1. Level Simulation Enable

Enables/disables level simulation.

Options	*	DISABLED
		ENABLED

3.4.1.2. Level Value

Sets the level for a fixed level simulation, or the starting level for a ramped simulation.

Values	Range: Low Calibration Point to High Calibration Point
	Default: 0.000

3.4.1.3. Ramp

Enables/disables ramped simulation.

Options	*	DISABLED
		ENABLED

3.4.1.4. Ramp Rate

Sets the rate at which the simulated level will change in a ramp simulation.

Options		SLOW	1% of span ^a per second
	*	MEDIUM	2% of span ^a per second
		FAST	4% of span ^a per second

^a. Low Calibration Point to High Calibration Point

3.4.2. Discrete Inputs

Simulates behaviour of external contacts connected to a discrete input.

3.4.2.1. Discrete Input 1

Disables simulation of Discrete Input 1, or sets behaviour of DI during simulation.

Options	*	DISABLED	DI is not simulated
		ON	DI is simulated to be ON
		OFF	DI is simulated to be OFF

3.4.2.2. Discrete Input 2

Disables simulation of Discrete Input 2, or sets behaviour of DI during simulation.

Options	*	DISABLED	DI is not simulated
		ON	DI is simulated to be ON
		OFF	DI is simulated to be OFF

3.4.3. Pump Activations

Sets how physical relays (that are assigned to pumps) will behave in simulation mode.

Options	*	DISABLED	Pump relays are not activated in simulation
		ENABLED	Pump relays are activated in simulation

4. Communication

4.1. Device Address

Sets the device address or poll ID on a HART network.

Values	Range: 0 to 63 (Set within range of 0 to 15 if HART 5 master used.)
	Default: 0

To reset Device Address via SIMATIC PDM:

- Open the project in **Process Device Network View** then right-click on the device.
- Go to **Object Properties** and open the **Connection** tab to access the field **Short Address**.

Note: The following list of parameters are available in PDM. Unless otherwise stated, the options are displayed in integer format (as required by HART communications).

Manufacturer's ID

Read only. Numerical code that refers to the manufacturer of the device (e.g. 42, which refers to Siemens).

Device Id

Read only. Unique identification of the device by manufacturer and device type.

Product Id

Read only. Unique identification of the product by model number.

Device Revision

Read only. Device revision associated with a specific EDD.

EDD Revision

Read only. Revision of a specific EDD associated with the device.

Universal Command Revision

Read only. Revision of the Universal Device Description associated with the device.

Protocol

Read only. The communication protocol supported by the device.

Common Practice Command Revision

Read only. Revision of the set of HART common practice commands supported by the device.

Configuration Change Counter

Read only. Indicates the number of times the device's configuration or calibration has been changed by a host application or from a local operator interface.

5. Security

Note: Default settings in the parameter tables are indicated with an asterisk (*) unless explicitly stated.

5.1. Write Protection

A public password to prevent any changes to parameters via local push buttons, remote communication, or Windows-based web browser.

Values		Range: 0 to 65535	
	*	Unlock value (2457)	Lock Off
		Any other value	Lock On

- To turn Lock On, key in any value other than the Unlock Value.
- To turn Lock Off, key in the Unlock Value (2457).

6. Language

Note: Default settings in the parameter tables are indicated with an asterisk (*) unless explicitly stated.

Selects the language to be used on the LCD.

Options	*	ENGLISH
		DEUTSCH
		FRANCAIS
		ESPANOL
		简体中文

Characteristics

Certificates & Approvals

Device Certification

The approvals certificates applicable to the device.

Alphabetical parameter list

Note: Maintenance Parameters are not listed below. See **Remaining Device Life** on page 204, **Remaining Sensor Life** on page 206, **Service Schedule** on page 209, and **Calibration Schedule** on page 211 for these parameters.

Parameter Name (Parameter Number)	Page Number
<i>4 mA Setpoint</i> (2.5.3.)	146
<i>20 mA Setpoint</i> (2.5.4.)	146
<i>Activation Time</i> (2.11.2.2.)	176
<i>Alarm Log</i> (2.10.2.)	174
<i>Alarm State</i> (2.8.1.5.): <i>High Level Alarm</i> (2.8.1.)	162
<i>Alarm State</i> (2.8.10.5.): <i>Low Flowrate Alarm</i> (2.8.10.)	169
<i>Alarm State</i> (2.8.2.5.): <i>Low Level Alarm</i> (2.8.2.)	163
<i>Alarm State</i> (2.8.3.5.): <i>Switch (Discrete Input) Alarm</i> (2.8.3.)	164
<i>Alarm State</i> (2.8.4.5.): <i>In-bounds Level Alarm</i> (2.8.4.)	165
<i>Alarm State</i> (2.8.5.5.): <i>Out-of-bounds Level Alarm</i> (2.8.5.)	166
<i>Alarm State</i> (2.8.6.5.): <i>Low Temperature Alarm</i> (2.8.6.)	166
<i>Alarm State</i> (2.8.7.5.): <i>High Temperature Alarm</i> (2.8.7.)	167
<i>Alarm State</i> (2.8.8.3.): <i>Fail-safe Fault Alarm</i> (2.8.8.)	166
<i>Alarm State</i> (2.8.9.5.): <i>High Flowrate Alarm</i> (2.8.9.)	169
<i>Alarms</i> (2.8.): <i>Setup</i> (2.)	162
<i>Alarms</i> (3.2.6.1.): <i>View Logs</i> (3.2.6.)	201
<i>Algorithm</i> (2.12.2.1.)	181
<i>Assigned Relay</i> (2.11.1.4.): <i>Elapsed Time Relay</i> (2.11.1.)	176
<i>Assigned Relay</i> (2.11.2.4.): <i>Time of Day Relay</i> (2.11.2.)	176
<i>Assigned Relay</i> (2.11.3.4.): <i>External Totalizer</i> (2.11.3.)	177
<i>Assigned Relay</i> (2.11.4.5.): <i>External Sampler</i> (2.11.4.)	179
<i>Assigned Relay</i> (2.8.1.4.): <i>High Level Alarm</i> (2.8.1.)	162
<i>Assigned Relay</i> (2.8.10.4.): <i>Low Flowrate Alarm</i> (2.8.10.)	169
<i>Assigned Relay</i> (2.8.2.4.): <i>Low Level Alarm</i> (2.8.2.)	163
<i>Assigned Relay</i> (2.8.3.4.): <i>Switch (Discrete Input) Alarm</i> (2.8.3.)	164
<i>Assigned Relay</i> (2.8.4.4.): <i>In-bounds Level Alarm</i> (2.8.4.)	165
<i>Assigned Relay</i> (2.8.5.4.): <i>Out-of-bounds Level Alarm</i> (2.8.5.)	165
<i>Assigned Relay</i> (2.8.6.4.): <i>Low Temperature Alarm</i> (2.8.6.)	166
<i>Assigned Relay</i> (2.8.7.4.): <i>High Temperature Alarm</i> (2.8.7.)	167
<i>Assigned Relay</i> (2.8.8.2.): <i>Fail-safe Fault Alarm</i> (2.8.8.)	166
<i>Assigned Relay</i> (2.8.9.4.): <i>High Flowrate Alarm</i> (2.8.9.)	168
<i>Auto False Echo Suppression</i> (2.12.3.1.)	183
<i>Auto False Echo Suppression Range</i> (2.12.3.2.)	184
<i>Auto Sensor Offset</i> (2.2.6.)	142
<i>Auto Sound Velocity</i> (2.12.1.6.)	181
<i>Auto Zero Head</i> (2.15.2.)	190
<i>Backup Control</i> (3.3.2.)	204
<i>Backup Level Override</i> (2.9.1.)	171
<i>Basic Setup</i> (2.15.3.): <i>Flow</i> (2.15.)	191
<i>Basic Setup</i> (2.7.1.): <i>Pumps</i> (2.7.)	151
<i>Breakpoint 1-8</i> (2.12.4.1.)	185
<i>Breakpoint 17-24</i> (2.12.4.3.)	185
<i>Breakpoint 25-32</i> (2.12.4.4.)	185
<i>Breakpoint 33-40</i> (2.12.4.5.)	185
<i>Breakpoint 9-16</i> (2.12.4.2.)	185
<i>Calibration</i> (2.2.)	140
<i>Communication</i> (4.)	215
<i>Confidence</i> (3.2.9.2.)	202
<i>Current Output</i> (2.5.)	144
<i>Current Output Function</i> (2.5.1.)	144

Parameter Name (Parameter Number)	Page Number
<i>Current Output Value</i> (2.5.8.)	147
<i>Daily Totalizer</i> (2.16.1.)	197
<i>Daily Totals</i> (3.2.6.3.)	201
<i>Damping Filter</i> (2.3.3.)	143
<i>Data Logging</i> (2.10.)	173
<i>Date</i> (2.14.1.)	188
<i>Date and Time</i> (2.14.)	187
<i>Daylight Saving</i> (2.14.3.)	188
<i>Delay Between Starts</i> (2.7.2.4.1.)	160
<i>Descriptor</i> (3.1.3.)	199
<i>Device Address</i> (4.1.)	215
<i>Diagnostics</i> (3.2.)	200
<i>Dimension A</i> (2.6.4.)	149
<i>Dimension L</i> (2.6.5.)	149
<i>Discrete Input 1</i> (3.4.2.1.)	215
<i>Discrete Input 1 Logic</i> (2.9.2.1.)	172
<i>Discrete Input 1 Scaled State</i> (2.9.2.2.)	172
<i>Discrete Input 2</i> (3.4.2.2.)	215
<i>Discrete Input 2 Logic</i> (2.9.2.3.)	172
<i>Discrete Input 2 Scaled State</i> (2.9.2.4.)	172
<i>Discrete Input Logic</i> (2.9.2.)	172
<i>Discrete Input Number</i> (2.8.3.2.)	163
<i>Discrete Input Number</i> (2.9.1.3.)	171
<i>Discrete Input State</i> (2.8.3.3.)	164
<i>Discrete Inputs</i> (2.9.): <i>Setup</i> (2.)	170
<i>Discrete Inputs</i> (3.4.2.): <i>Simulation</i> (3.4.)	215
<i>Display</i> (2.13.)	186
<i>Distance Measurement</i> (2.12.5.3.)	186
<i>Echo Profile</i> (3.2.1.)	200
<i>Echo Quality</i> (3.2.9.)	202
<i>Echo Select</i> (2.12.2.)	181
<i>Echo Strength</i> (3.2.9.3.)	203
<i>Echo Threshold</i> (2.12.2.2.)	182
<i>Elapsed Time Relay</i> (2.11.1.)	175
<i>Empty Rate per Minute</i> (2.3.2.)	143
<i>Enable</i> (2.10.1.1.): <i>Process Value Log</i> (2.10.1.)	174
<i>Enable</i> (2.10.2.1.): <i>Alarm Log</i> (2.10.2.)	174
<i>Enable</i> (2.11.1.1.): <i>Elapsed Time Relay</i> (2.11.1.)	175
<i>Enable</i> (2.11.2.1.): <i>Time of Day Relay</i> (2.11.2.)	176
<i>Enable</i> (2.11.3.1.): <i>External Totalizer</i> (2.11.3.)	177
<i>Enable</i> (2.11.4.1.): <i>External Sampler</i> (2.11.4.)	178
<i>Enable</i> (2.14.3.1.): <i>Daylight Saving</i> (2.14.3.)	188
<i>Enable</i> (2.7.2.1.1.): <i>Wall Cling Reduction</i> (2.7.2.1.)	154
<i>Enable</i> (2.7.2.2.1.): <i>Energy Savings</i> (2.7.2.2.)	155
<i>Enable</i> (2.7.2.3.1.): <i>Pump Run-On</i> (2.7.2.3.)	159
<i>Enable</i> (2.8.1.1.): <i>High Level Alarm</i> (2.8.1.)	162
<i>Enable</i> (2.8.10.1.): <i>Low Flowrate Alarm</i> (2.8.10.)	169
<i>Enable</i> (2.8.2.1.): <i>Low Level Alarm</i> (2.8.2.)	163
<i>Enable</i> (2.8.3.1.): <i>Switch (Discrete Input) Alarm</i> (2.8.3.)	163
<i>Enable</i> (2.8.4.1.): <i>In-bounds Level Alarm</i> (2.8.4.)	164
<i>Enable</i> (2.8.5.1.): <i>Out-of-bounds Level Alarm</i> (2.8.5.)	165
<i>Enable</i> (2.8.6.1.): <i>Low Temperature Alarm</i> (2.8.6.)	166
<i>Enable</i> (2.8.7.1.): <i>High Temperature Alarm</i> (2.8.7.)	167
<i>Enable</i> (2.8.8.1.): <i>Fail-safe Fault Alarm</i> (2.8.8.)	167
<i>Enable</i> (2.8.9.1.): <i>High Flowrate Alarm</i> (2.8.9.)	168
<i>Enable</i> (2.9.1.1.): <i>Backup Level Override</i> (2.9.1.)	171
<i>Enable Pump 1</i> (2.9.3.1.)	173

Parameter Name (Parameter Number)	Page Number
<i>Enable Pump 2</i> (2.9.3.3.)	173
<i>Ending Day</i> (2.14.3.6.)	189
<i>Ending Month</i> (2.14.3.7.)	189
<i>Ending Ordinal</i> (2.14.3.5.)	189
<i>Energy Savings</i> (2.7.2.2.)	155
<i>External Sampler</i> (2.11.4.)	178
<i>External Totalizer</i> (2.11.3.)	177
<i>Fail-Safe</i> (2.4.)	143
<i>Fail-safe Fault Alarm</i> (2.8.8.)	166
<i>Fail-Safe mA Value</i> (2.4.3.)	144
<i>Far Range</i> (2.2.5.)	141
<i>Figure of Merit</i> (3.2.9.1.)	202
<i>Fill Rate per Minute</i> (2.3.1.)	142
<i>Firmware Revision</i> (3.1.11.)	199
<i>Fixed Temperature</i> (2.12.1.4.)	180
<i>Flow</i> (2.15.)	189
<i>Flow Exponent</i> (2.15.3.2.)	191
<i>Flow Log</i> (2.10.3.)	174
<i>Flow Log Mode</i> (2.10.3.1.)	174
<i>Flow Measurement</i> (2.12.5.6.)	186
<i>Flowrate Decimal</i> (2.15.3.6.)	193
<i>Flowrate Units</i> (2.15.3.7.)	193
<i>Frequency</i> (2.1.7.)	140
<i>Hardware Revision</i> (3.1.10.)	199
<i>Head Measurement</i> (2.12.5.5.)	186
<i>High Calibration Point</i> (2.2.2.)	141
<i>High Flowrate Alarm</i> (2.8.9.)	168
<i>High Flowrate Value OFF</i> (2.8.9.3.)	168
<i>High Flowrate Value ON</i> (2.8.9.2.)	168
<i>High Level Alarm</i> (2.8.1.)	162
<i>High Level Value</i> (2.8.4.2.)	164
<i>High Level Value</i> (2.8.5.2.)	165
<i>High Level Value OFF</i> (2.8.1.3.)	162
<i>High Level Value ON</i> (2.8.1.2.)	162
<i>High Temperature Alarm</i> (2.8.7.)	166
<i>High Temperature Value OFF</i> (2.8.7.3.)	167
<i>High Temperature Value ON</i> (2.8.7.2.)	167
<i>Highest Value</i> (3.2.8.1.)	202
<i>Hover Level</i> (2.12.3.3.)	184
<i>Identification</i> (3.1.)	198
<i>In-bounds Level Alarm</i> (2.8.4.)	164
<i>Inflow/Discharge Adjust</i> (2.7.3.4.)	161
<i>Installation Date</i> (3.1.5.)	199
<i>Interval</i> (2.11.1.2.): <i>Elapsed Time Relay</i> (2.11.1.)	175
<i>Interval</i> (2.11.4.3.): <i>External Sampler</i> (2.11.4.)	178
<i>K Factor</i> (2.15.4.1.)	195
<i>Language</i> (6.)	217
<i>LCD Contrast</i> (2.13.2.)	187
<i>Level</i> (3.4.1.)	214
<i>Level Measurement</i> (2.12.5.1.)	186
<i>Level Override Value</i> (2.9.1.2.)	171
<i>Level Setpoint Variation</i> (2.7.2.1.2.)	154
<i>Level Simulation Enable</i> (3.4.1.1.)	214
<i>Level To Spill</i> (2.8.12.1.)	170
<i>Level Value</i> (3.4.1.2.)	214
<i>Loader Revision</i> (3.1.12.)	199
<i>Local Display Backlight</i> (2.13.1.)	186

Parameter Name (Parameter Number)	Page Number
<i>LOE Timer</i> (2.4.2.)	144
<i>Long Shot Duration</i> (2.1.8.)	140
<i>Long TAG</i> (3.1.2.)	199
<i>Low Calibration Point</i> (2.2.1.)	140
<i>Low Flow Cutoff</i> (2.15.3.9.)	193
<i>Low Flowrate Alarm</i> (2.8.10.)	169
<i>Low Flowrate Value OFF</i> (2.8.10.3.)	169
<i>Low Flowrate Value ON</i> (2.8.10.2.)	169
<i>Low Level Alarm</i> (2.8.2.)	163
<i>Low Level Value</i> (2.8.4.3.): <i>In-bounds Level Alarm</i> (2.8.4.)	164
<i>Low Level Value</i> (2.8.5.3.): <i>Out-of-bounds Level Alarm</i> (2.8.5.)	165
<i>Low Level Value OFF</i> (2.8.2.3.)	163
<i>Low Level Value ON</i> (2.8.2.2.)	163
<i>Low Temperature Alarm</i> (2.8.6.)	166
<i>Low Temperature Value OFF</i> (2.8.6.3.)	166
<i>Low Temperature Value ON</i> (2.8.6.2.)	166
<i>Lowest Value</i> (3.2.8.2.)	202
<i>Maintenance</i> (3.3.)	203
<i>Maintenance and Diagnostics</i> (3.)	198
<i>Manual Value</i> (2.5.7.)	147
<i>Manufacture Date (Date of Manufacturing in PDM)</i> (3.1.13.)	199
<i>Master Reset</i> (3.2.3.)	200
<i>Material Level</i> (2.4.1.)	143
<i>Maximum Flow at 20 mA</i> (2.15.3.4.)	192
<i>Maximum Head</i> (2.15.3.3.)	192
<i>Maximum mA Limit</i> (2.5.6.)	146
<i>Maximum Volume</i> (2.6.3.)	149
<i>Measured Values</i> (2.12.5.)	186
<i>Message</i> (3.1.4.)	199
<i>Method of Flow Calculation</i> (2.15.3.1.)	191
<i>Minimum mA Limit</i> (2.5.5.)	146
<i>Minutes Left To Spill</i> (2.8.12.2.)	170
<i>Modifiers</i> (2.7.2.)	154
<i>Multiplier</i> (2.11.3.2.): <i>External Totalizer</i> (2.11.3.)	177
<i>Multiplier</i> (2.11.4.2.): <i>External Sampler</i> (2.11.4.)	178
<i>Narrow Echo Filter</i> (2.12.2.4.)	182
<i>Near Range</i> (2.2.4.)	141
<i>Noise Average</i> (3.2.9.4.)	203
<i>Noise Peak</i> (3.2.9.5.)	203
<i>OCM</i> (3.2.6.2.)	201
<i>OCM Dimension 1</i> (2.15.4.5.)	196
<i>OCM Dimension 2</i> (2.15.4.6.)	196
<i>OCM Dimension 3</i> (2.15.4.7.)	196
<i>OCM Dimension 4</i> (2.15.4.8.)	196
<i>OFF Setpoint Pump 1</i> (2.7.1.7.)	152
<i>OFF Setpoint Pump 2</i> (2.7.1.9.)	153
<i>ON Setpoint Pump 1</i> (2.7.1.6.)	152
<i>ON Setpoint Pump 2</i> (2.7.1.8.)	152
<i>Open the menu Device – Select Analog Output.</i> ()	145
<i>Order Option</i> (3.1.14.)	200
<i>Other Control</i> (2.11.)	175
<i>Out-of-bounds Level Alarm</i> (2.8.5.)	165
<i>Peak 1 End Time</i> (2.7.2.2.4.)	156
<i>Peak 1 Start Time</i> (2.7.2.2.3.)	155
<i>Peak 2 End Time</i> (2.7.2.2.6.)	156
<i>Peak 2 Start Time</i> (2.7.2.2.5.)	156
<i>Peak 3 End Time</i> (2.7.2.2.8.)	157

Parameter Name (Parameter Number)	Page Number
<i>Peak 3 Start Time</i> (2.7.2.2.7.)	156
<i>Peak 4 End Time</i> (2.7.2.2.10.)	157
<i>Peak 4 Start Time</i> (2.7.2.2.9.)	157
<i>Peak 5 End Time</i> (2.7.2.2.12.)	157
<i>Peak 5 Start Time</i> (2.7.2.2.11.)	157
<i>Peak Lead Time</i> (2.7.2.2.2.)	155
<i>Peak OFF Setpoint Pump 1</i> (2.7.2.2.14.)	158
<i>Peak OFF Setpoint Pump 2</i> (2.7.2.2.16.)	158
<i>Peak ON Setpoint Pump 2</i> (2.7.2.2.15.)	158
<i>PMD Dimensions</i> (2.15.4.)	193
<i>Power Resumption Delay</i> (2.7.2.4.2.)	160
<i>Power-on Resets</i> (3.2.4.)	201
<i>Power-on Time</i> (3.2.5.)	201
<i>Primary Measuring Device (PMD)</i> (2.15.1.)	190
<i>Process Temperature</i> (2.12.1.2.)	179
<i>Process Value Log</i> (2.10.1.)	174
<i>Process Values Log Rate</i> (2.10.1.2.)	174
<i>Product</i> (3.1.6.)	199
<i>Pump 1 Discrete Input</i> (2.9.3.2.)	173
<i>Pump 2 Discrete Input</i> (2.9.3.4.)	173
<i>Pump Activations</i> (3.4.3.)	215
<i>Pump Control</i> (1.2.)	138
<i>Pump Control Enable</i> (2.7.1.1.)	151
<i>Pump Control Mode</i> (2.7.1.4.)	151
<i>Pump Interlock</i> (2.9.3.)	173
<i>Pump Records</i> (3.2.7.)	202
<i>Pump Run-On</i> (2.7.2.3.)	159
<i>Pump Start Delays</i> (2.7.2.4.)	160
<i>Pumps</i> (2.7.)	151
<i>PV</i> (3.2.6.4.)	201
<i>QS Flow</i> (1.1.3.)	138
<i>QS Level</i> (1.1.1.)	138
<i>QS Volume</i> (1.1.2.)	138
<i>Quick Start</i> (1.1.)	138
<i>Ramp</i> (3.4.1.3.)	214
<i>Ramp Rate</i> (3.4.1.4.)	214
<i>Rapid Flow Log Interval</i> (2.10.3.5.)	175
<i>Rapid Flow Log Setpoint</i> (2.10.3.6.)	175
<i>Rate</i> (2.3.)	142
<i>Reform Echo</i> (2.12.2.3.)	182
<i>Relay 1 Logic</i> (2.8.11.1.)	170
<i>Relay 2 Logic</i> (2.8.11.2.)	170
<i>Relay 3 Logic</i> (2.8.11.3.)	170
<i>Relay Duration</i> (2.11.1.3.): <i>Elapsed Time Relay</i> (2.11.1.)	175
<i>Relay Duration</i> (2.11.2.3.): <i>Time of Day Relay</i> (2.11.2.)	176
<i>Relay Duration</i> (2.11.3.3.): <i>External Totalizer</i> (2.11.3.)	177
<i>Relay Duration</i> (2.11.4.4.): <i>External Sampler</i> (2.11.4.)	179
<i>Relay Logic</i> (2.11.1.5.): <i>Elapsed Time Relay</i> (2.11.1.)	176
<i>Relay Logic</i> (2.11.2.5.): <i>Time of Day Relay</i> (2.11.2.)	177
<i>Relay Logic</i> (2.11.3.5.): <i>External Totalizer</i> (2.11.3.)	178
<i>Relay Logic</i> (2.11.4.6.): <i>External Sampler</i> (2.11.4.)	179
<i>Relay Logic</i> (2.8.11.): <i>High Level Alarm</i> (2.8.1.)	169
<i>Relay Pump 1</i> (2.7.1.2.): <i>Basic Setup</i> (2.7.1.)	151
<i>Relay Pump 1</i> (3.2.7.3.): <i>Pump Records</i> (3.2.7.)	202
<i>Relay Pump 2</i> (2.7.1.3.): <i>Basic Setup</i> (2.7.1.)	151
<i>Relay Pump 2</i> (3.2.7.4.): <i>Pump Records</i> (3.2.7.)	202
<i>Reset Daily Totalizer</i> (2.16.5.)	198

Parameter Name (Parameter Number)	Page Number
<i>Reset Running Totalizer</i> (2.16.6.): <i>Totalizers</i> (2.16.)	198
<i>Reset Running Totalizer</i> (2.7.3.5.): <i>Pumps</i> (2.7.)	161
<i>Roughness Coefficient</i> (2.15.4.4.)	196
<i>Run Time Relay 2</i> (3.2.7.1.)	202
<i>Run Time Relay 3</i> (3.2.7.2.)	202
<i>Run-On Duration Pump 1</i> (2.7.2.3.3.)	159
<i>Run-On Duration Pump 2</i> (2.7.2.3.4.)	159
<i>Run-On Interval</i> (2.7.2.3.2.)	159
<i>Running Totalizer</i> (2.16.2.): <i>Totalizers</i> (2.16.)	197
<i>Running Totalizer</i> (2.7.3.1.): <i>Pumps</i> (2.7.)	160
<i>Security</i> (5.)	216
<i>Sensor</i> (2.1.)	138
<i>Sensor Mode</i> (2.1.2.)	138
<i>Sensor Offset</i> (2.2.3.)	141
<i>Serial Number</i> (3.1.8.)	199
<i>Service Ratio Pump 1</i> (2.7.1.10.)	153
<i>Service Ratio Pump 2</i> (2.7.1.11.)	153
<i>Setup</i> (2.)	138
<i>Shaper Mode</i> (2.12.3.4.)	184
<i>Short Shot Duration</i> (2.1.9.)	140
<i>Signal Processing</i> (2.12.)	179
<i>Simulation</i> (3.4.)	214
<i>Slope</i> (2.15.4.3.)	196
<i>Sound Velocity</i> (2.12.1.1.)	179
<i>Sound Velocity at 20 degrees C</i> (2.12.1.5.)	180
<i>Space Measurement</i> (2.12.5.2.)	186
<i>Standard Flow Log Interval</i> (2.10.3.3.)	174
<i>Standard Flow Log Setpoint</i> (2.10.3.4.)	175
<i>Starting Day</i> (2.14.3.3.)	189
<i>Starting Month</i> (2.14.3.4.)	189
<i>Starting Ordinal</i> (2.14.3.2.)	188
<i>Submergence Detection</i> (2.12.2.5.)	182
<i>Switch (Discrete Input) Alarm</i> (2.8.3.)	163
<i>Table 1-8</i> (2.15.5.1.): <i>Universal Head vs. Flow</i> (2.15.5.)	197
<i>Table 1-8</i> (2.6.7.): <i>Volume</i> (2.6.)	150
<i>Table 17-24</i> (2.15.5.3.): <i>Universal Head vs. Flow</i> (2.15.5.)	197
<i>Table 17-24</i> (2.6.9.): <i>Volume</i> (2.6.)	151
<i>Table 25-32</i> (2.15.5.4.): <i>Universal Head vs. Flow</i> (2.15.5.)	197
<i>Table 25-32</i> (2.6.10.): <i>Volume</i> (2.6.)	151
<i>Table 9-16</i> (2.15.5.2.): <i>Universal Head vs. Flow</i> (2.15.5.)	197
<i>Table 9-16</i> (2.6.8.): <i>Volume</i> (2.6.)	151
<i>TAG</i> (3.1.1.)	198
<i>Temperature and Velocity</i> (2.12.1.)	179
<i>Temperature Peak Values</i> (3.2.8.)	202
<i>Temperature Source</i> (2.12.1.3.)	180
<i>Time</i> (2.14.2.)	188
<i>Time of Day Relay</i> (2.11.2.)	176
<i>Time To Spill</i> (2.8.12.)	170
<i>Totalizer Decimal Position</i> (2.16.3.): <i>Totalizers</i> (2.16.)	197
<i>Totalizer Decimal Position</i> (2.7.3.2.): <i>Pumps</i> (2.7.)	160
<i>Totalizer Multiplier</i> (2.16.4.): <i>Totalizers</i> (2.16.)	198
<i>Totalizer Multiplier</i> (2.7.3.3.): <i>Pumps</i> (2.7.)	161
<i>Totalizers</i> (2.16.): <i>Setup</i> (2.)	197
<i>Totalizers</i> (2.7.3.): <i>Pumps</i> (2.7.)	160
<i>Transducer</i> (2.1.6.)	140
<i>Transducer Enable</i> (3.3.1.)	203
<i>Trend</i> (3.2.2.)	200

Parameter Name (Parameter Number)	Page Number
<i>TVT Setup</i> (2.12.3.)	183
<i>TVT Shaper</i> (2.12.4.)	184
<i>Units</i> (2.1.1.)	138
<i>Universal Head vs. Flow</i> (2.15.5.)	196
<i>User Defined Unit</i> (2.15.3.8.): <i>Flow</i> (2.15.)	193
<i>User Defined Unit</i> (2.6.6.): <i>Volume</i> (2.6.)	149
<i>V-Notch Angle</i> (2.15.4.2.)	196
<i>Vessel Shape</i> (2.6.1.)	147
<i>View Logs</i> (3.2.6.)	201
<i>Volume</i> (2.6.)	147
<i>Volume Measurement</i> (2.12.5.4.)	186
<i>Volume Units</i> (2.6.2.)	149
<i>Wall Cling Reduction</i> (2.7.2.1.)	154
<i>Wizards</i> (1.)	137
<i>Write Protection</i> (5.1.)	216
<i>Zero Head Offset</i> (2.15.3.5.)	192

Service and Maintenance

SITRANS LUT400 requires no maintenance or cleaning under normal operating conditions.

Firmware updates

To update the LUT400 firmware, please contact your Siemens representative to obtain the installer (self-executable .exe file). For a complete list of representatives, go to www.siemens.com/processautomation.

Two installers are available: one to update the firmware in the Local User Interface (LUI) node, and one for the sensor node. One or both may be required, depending on the reason for the update.

To complete an update, follow steps in the installer:

1. Connect your computer to the SITRANS LUT400 USB port.
2. Before running the .exe installer received from your Siemens representative, note the computer COM port to which the LUT400 is connected.
3. From your computer, double-click the .exe, and follow the installer steps. The first step will prompt for Communication Options. These options are set to factory defaults. Ensure the COM Port is set to that noted in step 2 above. No other changes are required.
4. Follow remaining installer steps.
5. Once complete, verify the update was successful by checking the current firmware revision:
 - If updating the **LUI node**, recycle the power on the LUT400. On power-up, you will see the current LUI firmware revision on the LUT400 display.
 - If updating the **sensor node**, view parameter Firmware Revision (3.1.11.) to see the current sensor node firmware revision.

Complete a Master Reset (3.2.3.) to factory defaults after a successful upgrade of the sensor node, before re-entering parameters.

Transferring parameters using LUT400 display lid

If necessary to transfer parameters from one LUT400 to another, the LUI display maintains a backup file of the parameters on the device. With this backup file, it is possible to connect the remote lid to a second LUT400 to transfer parameters.

When the remote lid is connected to a second device, a fault code is displayed to note that the LUI backup file does not match the configuration file in the sensor. You can then use the Backup Control parameter to specify that sensor parameters be copied from the LUI backup to the device [see Backup Control (3.3.2.) on page 204].

Replacing the Battery

The battery (BR2032) has a life expectancy of ten years, and is affected by ambient temperature. If the device loses external power the battery will maintain the SITRANS LUT400's Real Time Clock (date and time) until power is restored.

The flash memory is updated constantly. Therefore, data logs are unaffected by the loss of power.



WARNING: Disconnect power before replacing the battery.

Notes:

- To replace, remove the existing battery from the holder as shown below, and reinstall replacement battery (BR2032).
- Battery Type: Lithium metal coin cell
Battery Chemistry: solid-cathode Carbon Monofluoride



Dispose of battery in an environmentally safe manner, and according to local regulations.

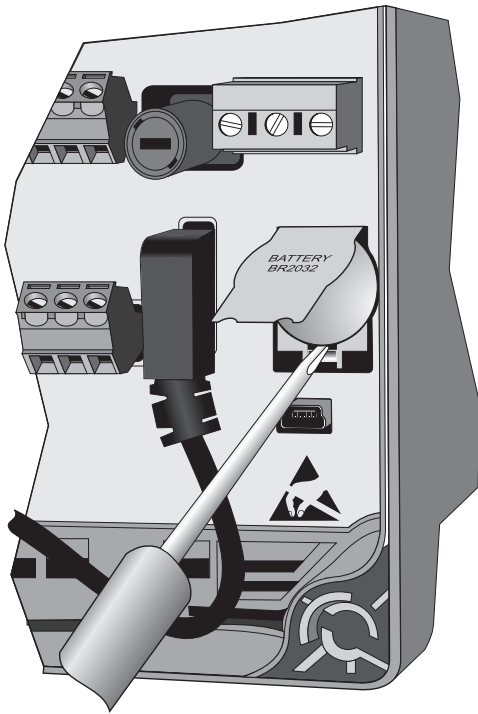

1. Open the enclosure lid.
2. Slide the end of a screwdriver under the lip of the plastic battery cover, and lift cover with fingers. (Do not press back on fold.)
3. While holding cover in raised position, place end of screwdriver at an angle into slot below battery, and pry upward.
4. Lift out battery.
5. Insert new battery and press down on face of battery to secure in holder.
6. Press down on plastic battery cover to secure in place.
7. Close enclosure lid and tighten screws.
8. Reset the Real Time Clock (See **Date and Time (2.14.)** on page 187.)

Decontamination Declaration

Any device returned to Siemens for repair must be accompanied by a Declaration of Decontamination. With this declaration you certify *that the returned products/spare parts have been carefully cleaned and are free from any residues.*

If the device has been operated together with toxic, caustic, flammable or water-damaging products, clean the device before return by rinsing or neutralizing. Ensure that all cavities are free from dangerous substances. Then, double-check the device to ensure the cleaning is completed.

Siemens will not service a device or spare part unless the declaration of decontamination confirms proper decontamination of the device or spare part.

Shipments received without a declaration of decontamination will be cleaned professionally at your expense before further processing.

Decontamination Declaration form can be found on the internet at www.siemens.com/processinstrumentation, under Service – Decontamination Declaration.

Notes

Notes:

- Many of the parameters referenced and techniques described here require a good understanding of ultrasonic technologies and Siemens echo processing software. Use this information with caution.
- If the setup becomes too confusing do a *3.2.3. Master Reset* and start again.
- As a further resource, *Understanding Ultrasonic Level Measurement* is available on our website. Go to www.siemens.com/level.

Communication Troubleshooting

Generally

1. Check the following:
 - There is power at the device
 - The optional LCD is showing the relevant data
 - The device can be programmed using the local push buttons.
 - If any fault codes are being displayed, see “General Fault Codes” on page 231 for a detailed list.
2. Verify that the wiring connections are correct.

Specifically

1. The SITRANS LUT400 is set to communicate via a HART modem but no communication is returning to the master.
 - Check that the device address is set correctly for the HART network.
2. A SITRANS LUT400 parameter is set via remote communications, but the parameter remains unchanged.
 - Try setting the parameter from the local push buttons. If it can not be set using the buttons, ensure *5.1. Write Protection* is set to the unlock value.

If you continue to experience problems, go to our website at:

www.siemens.com/sitransLUT400, and check the FAQs for SITRANS LUT400, or contact your Siemens representative.

Device Status Icons

LUI Icon	PDM Icon	Priority Level ^a	Meaning
		1	<ul style="list-style-type: none"> Maintenance alarm Measurement values are not valid
		2	<ul style="list-style-type: none"> Maintenance warning: maintenance demanded immediately Measured signal still valid
		3	<ul style="list-style-type: none"> Maintenance required Measured signal still valid
		1	<ul style="list-style-type: none"> Process value has reached an alarm limit
		2	<ul style="list-style-type: none"> Process value has reached a warning limit
		3	<ul style="list-style-type: none"> Process value has reached a tolerance limit
		1	<ul style="list-style-type: none"> Configuration error Device will not work because one or more parameters/components is incorrectly configured
		2	<ul style="list-style-type: none"> Configuration warning Device can work but one or more parameters/components is incorrectly configured
		3	<ul style="list-style-type: none"> Configuration changed Device parameterization not consistent with parameterization in project. Look for info text.
		1	<ul style="list-style-type: none"> Manual operation (local override) Communication is good; device is in manual mode.
		2	<ul style="list-style-type: none"> Simulation or substitute value Communication is good; device is in simulation mode or works with substitute values.
		3	<ul style="list-style-type: none"> Out of operation Communication is good; device is out of action.

LUI Icon	PDM Icon	Priority Level ^a	Meaning (Continued)
			<ul style="list-style-type: none"> Data exchanged
			<ul style="list-style-type: none"> No data exchange
			<ul style="list-style-type: none"> Write access enabled
			<ul style="list-style-type: none"> Write access disabled

^a. Lowest priority number equals highest fault severity.

General Fault Codes



















Notes:

- If two faults are present at the same time, the device status indicator and text for the highest priority fault will display.
- Certain faults exist, such as with a loss of echo (LOE) or a broken cable, that when triggered cause the mA output to go to a fail-safe reading (see “Fail-Safe” on page 143) and LUI to display dashes (-----) until fault is cleared. These faults are indicated with an asterisk (*) in the table below.

General Fault Codes

Code / LUI Icon	Code / PDM Icon	Meaning	Corrective Action
0 	0 	* Loss of echo (LOE). The device was unable to get a measurement within the Fail-safe LOE Timer period. Possible causes: faulty installation, foaming/other adverse process conditions, invalid calibration range.	<ul style="list-style-type: none"> Ensure installation details are correct. Adjust process conditions to minimize adverse conditions. Correct range calibration. If fault persists, contact your local Siemens representative.
1 	1 	* Cable fault. Broken cable.	Inspect attached cabling and any termination points to ensure no disconnection or damage; repair/replace if necessary. If no issue with cabling, contact your local Siemens representative.
3 	3 	Device is nearing its lifetime limit according to the value set in Maintenance Required Limit.	Replacement is recommended.

General Fault Codes (Continued)























Code / LUI Icon	Code / PDM Icon	Meaning	Corrective Action
4 	4 	Device is nearing its lifetime limit according to the value set in Maintenance Demanded Limit.	Replacement is recommended.
5 		Saving Parameters. (LUI fault only.) Saving is in progress. Do not turn off the device.	Wait for completion.
6 	6 	Sensor is nearing its lifetime limit according to the value set in Maintenance Required Limit.	Replacement is recommended.
7 	7 	Sensor is nearing its lifetime limit according to the value set in Maintenance Demanded Limit.	Replacement is recommended.
8 	8 	Service interval as defined in Maintenance Required Limit has expired.	Perform service.
9 	9 	Service interval as defined in Maintenance Demanded Limit has expired.	Perform service.
10 	10  (red)	Configuration parameters are incorrect. The following conditions will cause this fault: <ul style="list-style-type: none"> • Far Range < Low Cal. Pt. • Near Range > Far Range • Low Cal. Pt - High Cal. Pt. < 10 cm • Far Range - Near Range < 10 cm • Max. mA Limit ≤ Min. mA Limit • Current Output Function set to <i>Volume</i>, but Vessel Shape set to <i>None</i> • Current Output Function set to <i>Volume</i>, but Max. Volume has not been set. 	Check device configuration.
17 	17 	Calibration interval as defined in Maintenance Required Limit has expired.	Perform calibration.
18 	18 	Calibration interval as defined in Maintenance Demanded Limit has expired.	Perform calibration.
25 	25 	Internal device error.	Reset power. If fault persists, contact your local Siemens representative.

**General Fault Codes
(Continued)**















**Code / Code /
LUI PDM
Icon Icon**

Meaning

Corrective Action

26 	26 	*	Submergence detected. The transducer appears submerged.	Correct the installation.
27 	27  (red)		Incorrect product model. Basic model does not support flow and advanced pump control features	Only configure the supported features.
39 	39 	*	Transducer temperature sensor has failed.	Inspect attached cabling and any termination points to ensure no disconnection or damage; repair/ replace if necessary. If no issue with cabling, contact your local Siemens representative.
46 	46 	*	The TS-3 temperature sensor failed.	Inspect attached cabling and any termination points to ensure no disconnection or damage; repair/ replace if necessary. If no issue with cabling, contact your local Siemens representative.
47 	47 		Poor signal from the application. Poor installation or high noise level.	Verify installation.
121 	121  (red)		Flow calculations are not config- ured properly. Incorrect parameter settings.	Reconfigure the unit. Check the configu- ration. If fault persists, do a master reset.
122 	122 		Flow calculations encountered an error.	Reconfigure the unit. Check the break- points. If fault persists, do a master reset.
123 	123 		Flow log could not restore the settings.	Reconfigure the unit. Check the flow log settings. If fault persists, do a master reset.
124 	124  (red)		Flow log is not configured properly.	Reconfigure the unit. Check the flow log settings. If fault persists, do a master reset.
125 	125 		Flow log error. Log failed.	Verify that the drive where the log file resides is not full. Copy the log file to a computer and delete it from the device.
126 	126 		Failed to open log file.	Verify that the drive where the log file resides is not full. Copy the log file to a computer and delete it from the device.

General Fault Codes (Continued)

Code / LUI Icon	Code / PDM Icon	Meaning	Corrective Action
127 	127 	Failed to close log file.	Verify that the drive where the log file resides is not full. Copy the log file to a computer and delete it from the device.
128 	128 	Log file read error. Error reading file. Unexpected error.	Verify that the drive where the log file resides is not full. Copy the log file to a computer and delete it from the device.
129 	129 	Log file write error. Error writing file. The file could not be written; the disk is full.	Copy the log file to a computer and delete it from the device.
130 	130  (red)	Configuration error. One or more settings invalid.	Adjust/correct relay assignments or setpoints.
131 	131 	Parameter backup did not succeed. Communication or file system problems.	Repair required. Contact your local Siemens representative.
132 	132  (red)	User input required. Serial numbers mismatch.	Manually force recovery. (Set parameter <i>3.3.2. Backup Control</i>)
133 	133 	Simulation Enabled.	Simulation is active. Enable or disable simulation via LUI (<i>3.4.1.1. Level Simulation Enable, 3.4.2.1. Discrete Input 1, 3.4.2.2. Discrete Input 2</i>).

Common Problems Chart

Symptom	Possible Cause	Action
Display blank, transducer not pulsing	No power, incorrect power	Check mains voltage at terminals; Check fuse; Check wiring connections; Check wiring.
Display blank, transducer is pulsing	Loose or disconnected display cable	Reconnect display cable.
Display active, transducer not pulsing	Incorrect transducer connections or wiring; Incorrect transducer selection (or set to NO Transducer); Transducer has been disabled through the software	Verify terminal connections; Check transducer field wiring; Check any junction box connections; Check that transducer is enabled (see Transducer Enable (3.3.1) on page 203)

Symptom	Cause	Action
Reading fluctuates while material level is still	Material level is changing	Visually verify, if possible.
	Strong false echoes	Determine source of false echoes; Relocate transducer to avoid source.
	Incorrect damping	Adjust damping. See Damping Filter (2.3.3.) on page 143.
	Improper echo Algorithm selection	Set algorithm to default. If no improvement, try a different algorithm. See Algorithm (2.12.2.1.) on page 181.
	High noise levels	Verify source and minimize. See "Noise Problems" on page 240.
	Weak echo	Determine cause; Check noise, confidence, FOM, and echo strength. See Echo Quality (3.2.9.) on page 202.
	Foam on surface of material	Eliminate source of foaming; Use stilling well.
	Rapid temperature changes	Use an external temperature sensor. See Temperature Source (2.12.1.3.) on page 180.
	Faulty temperature sensor	Verify operation; Replace if required, or use fixed temperature. See Temperature Source (2.12.1.3.) on page 180.
Vapours	If fluctuation is unacceptable, consider an alternative technology. Contact your Siemens representative.	

Symptom	Cause	Action
Reading is fixed, but material level changes or reading does not follow material level	Incorrect speed of response	Verify response speed setting is adequate for process. See <i>Response Rate</i> (set in the Quick Start Wizard).
	Loss of Echo condition (LOE)	Check Noise, Echo Strength, Confidence. See Echo Quality (3.2.9.) on page 202. Check LOE Timer is not set too short. See LOE Timer (2.4.2.) on page 144.
	Agitator blade stopped in front of transducer (false echo)	Ensure agitator is running.
	Foam on surface of material	Eliminate source of foaming. Use stilling well
	Incorrect Algorithm used	Set algorithm to default. If no improvement, try a different algorithm. See Algorithm (2.12.2.1.) on page 181.
	Transducer mounting: wrong location or incorrectly mounted	Ensure beam has a clear path to material surface; Verify transducer is not too tight; Use an isolation coupling.
	Incorrect transducer used for the application	Use correct transducer. Contact your Siemens representative.
	Unavoidable false echoes from obstructions	Relocate transducer to ensure beam has a clear path to material surface; Use manual TVT shaping or Auto False Echo Suppression. See TVT Shaper (2.12.4.) on page 184 or Auto False Echo Suppression (2.12.3.1.) on page 183.

Symptom	Cause	Action
Accuracy Varies	Faulty temperature sensor	Verify operation; Replace if required, or use fixed temperature. See Temperature Source (2.12.1.3.) on page 180.
	Vapours present in varying concentrations	Eliminate vapours or consider a different technology. Contact your Siemens representative.
	Thermal gradients	Insulate vessel; Consider external temperature sensor.
	Calibration required	If accuracy is better when level is close to transducer, and worse when level is far from transducer, perform calibration [see Auto Sound Velocity (2.12.1.6.) on page 181]. If accuracy is consistently incorrect, use Sensor Offset (2.2.3.) on page 141 or perform calibration [see Auto Sensor Offset (2.2.6.) on page 142].
Reading erratic	Transducer mounting: wrong location or incorrectly mounted	Ensure beam has a clear path to material surface; Verify transducer is not too tight; Use an isolation coupling.
	Unavoidable false echoes from obstructions	Use Auto False Echo Suppression. See Auto False Echo Suppression (2.12.3.1.) on page 183.
	Confidence too low	Check Noise, Echo Strength, Confidence. See Echo Quality (3.2.9.) on page 202. Check LOE Timer is not set too short. See LOE Timer (2.4.2.) on page 144.
	Multiple echoes	Check mounting location; Verify material is not entering Near Range zone. See Near Range (2.2.4.) on page 141.
	Noise in the application	Verify source and minimize. See “Noise Problems” on page 240.

Symptom	Cause	Action
Incorrect reading (mA output and/or displayed value)	mA function not assigned to correct measurement	Check mA assignment. See Current Output Function (2.5.1.) on page 144.
	When device configured for flow: exponent or breakpoint not correctly selected	Check configuration: if <i>2.1.2. Sensor Mode</i> set to FLOW , verify correct exponent [Flow Exponent (2.15.3.2.) on page 191] and breakpoints [Universal Head vs. Flow (2.15.5.) on page 196].
	Incorrect vessel or PMD dimensions	For volume application: Verify vessel dimensions. See Vessel Shape (2.6.1.) on page 147. For flow application: Verify PMD dimensions. See PMD Dimensions (2.15.4.) on page 193
Relay not activating	Relay not programmed	Program relay.
	Relay incorrectly assigned	Verify with simulation. See Simulation (3.4.) on page 214.
	Incorrect relay function selected	Verify with simulation. See Simulation (3.4.) on page 214.
	Incorrect relay setpoints	Verify setpoints.
Relay not activating correctly	Relay incorrectly assigned	Verify with simulation. See Simulation (3.4.) on page 214.
	Incorrect relay function selected	Verify with simulation. See Simulation (3.4.) on page 214.
	Incorrect relay setpoints	Verify setpoints.

Symptom	Cause	Action
No response when echo profile requested via LUI (3.2.1. Echo Profile)	Transducer is disabled.	Set Transducer Enable (3.3.1.) on page 203 to ENABLED, then request an echo profile.
Configuration error 130 displayed	Relay/pump configuration errors - possible causes include: <ul style="list-style-type: none"> • A relay is assigned to more than one function (e.g. relay 2 is assigned to both an external totalizer and a pump). • Pump setpoints are out of order. • Wall Cling adjustment range is too large. 	<ul style="list-style-type: none"> • Verify that each relay is assigned to one function only. Review relay assignments under Pump Control (page 151) and Other Control functions (page 175). • Verify that all 'ON' setpoints are greater than their respective 'OFF' setpoints for pump down applications (or vica versa for pump up applications). • Ensure range set in Level Setpoint Variation (2.7.2.1.2.) on page 154 has not caused 'ON' or 'OFF' setpoints to overlap.
Echo profile request results in an error icon that displays for 5 seconds before returning to the echo profile request menu.	Another external communication is trying to access an echo profile at the same time.	Wait for several seconds and then retry the echo profile request, or disconnect / disable any external communications that may be requesting an echo profile.
Data log files are empty or logging has stopped.	<ul style="list-style-type: none"> • Data Logging is not enabled. • USB cable is connected. • USB extension cable has been used (although may not currently be connected). 	<ul style="list-style-type: none"> • Verify that Data Logging is enabled. See Data Logging (2.10.) on page 173. • Disconnect USB cable, as no data logs are written while device is connected to a PC via USB. • If a USB extension cable has been used (remove if currently connected), a power reset of the device is required to restart Data Logging.

Noise Problems

Incorrect readings can be the result of noise problems, either acoustic or electrical, in the application.

The noise present at the input to the ultrasonic receiver can be determined by viewing the echo profile locally via the LUI, or alternatively, using remote software such as SIMATIC PDM, AMS Device Manager, FC375/475, or DTM. View also parameters *3.2.9.4. Noise Average* and *3.2.9.5. Noise Peak*. In general, the most useful value is the average noise.

With no transducer attached the noise is under 5 dB. This is often called the noise floor. If the value with a transducer attached is greater than 5 dB, signal processing problems can occur. High noise decreases the maximum distance that can be measured. The exact relationship between noise and maximum distance is dependent on the transducer type and the material being measured. An average noise level greater than 30 dB may be cause for concern if the installed transducers maximum operation range matches the range of the application (e.g. 8 m application using an 8 m XRS-5). Using a larger transducer with greater transmitted energy should help to improve performance in a noise condition.

Determine the Noise Source

Disconnect the transducer from the SITRANS LUT400. If the measured noise is below 5 dB, then continue here. If the measured noise is above 5 dB go to *Non-Transducer Noise Sources* below.

1. Connect only the shield wire of the transducer to the SITRANS LUT400. If the measured noise is below 5 dB, continue with the next step. If the noise is above 5 dB, go to *Common Wiring Problems* below.
2. Connect the white and black transducer wires to the SITRANS LUT400. Record the average noise.
3. Remove the positive wire of the transducer. Record the average noise.
4. Re-connect the positive wire and remove the negative wire. Record the average noise.

Using the table below, determine the appropriate next step. The terms higher, lower and unchanged refer to the noise recorded in the previous steps.

These are guidelines only. If the suggested solution does not solve the problem, try the other options also.

	- removed	+ removed	Go to:
noise	higher	higher	<i>Reducing Electrical Noise</i>
		unchanged	<i>Common Wiring Problems</i>
		lower	<i>Reducing Acoustical Noise</i>
	unchanged	higher	<i>Reducing Electrical Noise</i>
		unchanged	Contact Siemens representative.
		lower	<i>Reducing Acoustical Noise</i>
	lower	higher	<i>Common Wiring Problems</i>
		unchanged	<i>Common Wiring Problems</i>
		lower	<i>Reducing Acoustical Noise</i>

Acoustical Noise

To confirm that the problem is acoustical, place several layers of cardboard over the face of the transducer. If the noise is reduced, the noise is definitely acoustical.

Non-Transducer Noise Sources

Remove all input and output cables from the SITRANS LUT400 individually while monitoring the noise. If removing a cable reduces the noise, that cable may be picking up noise from adjacent electrical equipment. Check that low voltage cables are not being run adjacent to high voltage cables or near to electrical noise generators such as variable speed drives.

Filtering cables is an option but is not recommended unless all other options have been exhausted.

The SITRANS LUT400 is designed to work near heavy industrial equipment such as variable speed drives. Even so, it should not be located near high voltage wires or switch gear.

Try moving the electronics to a different location. Often moving the electronics a few meters farther from the source of noise will fix the problem. Shielding the electronics is also an option, but it should be a last resort. Proper shielding is expensive and is difficult to install properly—the shielding box must enclose the SITRANS LUT400 electronics completely, and all wires must be brought to the box through grounded metal conduit.

Common Wiring Problems

- Make sure that the transducer shield wire is connected at the electronics end only. Do not ground it at any other location.
- Do not connect the transducer shield wire to the white wire.
- The exposed transducer shield wire must be as short as possible.
- Connections between the wire supplied with the transducer, and any customer installed extension wire should only be grounded at the LUT400.

On Siemens transducers the white wire is negative and the black wire is positive. If the extension wire is colored differently, make sure that it is wired consistently.

Extension wire must be shielded twisted pair. See the installation section for specifications.

Reducing Electrical Noise

- Ensure that the transducer cable does not run parallel to other cables carrying high voltage or current.
- Move the transducer cable away from noise generators like variable speed drives.
- Put the transducer cable in grounded metal conduit.
- Filter the noise source.
- Check grounding.

Reducing Acoustical Noise

- Move the transducer away from the noise source.
- Use a stilling well.
- Install a rubber or foam bushing or gasket between the transducer and the mounting surface.
- Relocate or insulate the noise source.
- Change the frequency of the noise. Ultrasonic devices are sensitive to noise in the frequency range of the transducer employed.
- Check that transducer is not mounted too tightly; only hand-tight.

Measurement Difficulties

If the *2.4.2. LOE Timer* expires due to a measurement difficulty, the *2.4.3. Fail-Safe mA Value* displays. In rare cases, the SITRANS LUT400 may lock on to a false echo and report a fixed or wrong reading.

Loss of Echo (LOE)

The *2.4.3. Fail-Safe mA Value* displays (seen in *2.5.8. Current Output Value*) when the echo confidence is below the threshold value set in *2.12.2.2. Echo Threshold*.

LOE occurs when:

- The echo is lost and no echo is shown above the ambient noise (see low *3.2.9.2. Confidence* and low *3.2.9.3. Echo Strength*)
- Two echoes are too similar to differentiate (when BLF algorithm used) (see low *3.2.9.2. Confidence* and low *3.2.9.3. Echo Strength*)
- No echo can be detected within the programmed range (see *2.2.5. Far Range*).

If *2.4.3. Fail-Safe mA Value* is displayed, check the following:

- Surface monitored is within the transducer maximum range
- *2.1.6. Transducer* model matches the transducer used
- Transducer is located and aimed properly
- Transducer (that is installed without a submergence shield) is not submerged

Adjust Transducer Aiming

See the transducer manual for range, mounting, and aiming details. For optimum performance, adjust transducer aiming to provide the best *3.2.9.2. Confidence* and *3.2.9.3. Echo Strength* for all material levels within the measurement range.

Displaying Echoes

The most efficient method of checking echoes is locally via the LUI, or remotely using SIMATIC PDM, AMS, FC375/475, or DTM software.

Use LUI or remote software to graphically display the echo profile at the installation. Interpret the echo profile and change relevant parameters. For LUI, see “Requesting an Echo Profile” on page 57, and for details on how to interpret an Echo Profile, see “Echo Processing” on page 255.

Increase Fail-safe Timer Value

Increase the *2.4.2. LOE Timer* value, if fail-safe operation will not be compromised by the larger value.

Try this only if LOE exists for short periods of time.

Install a Transducer with a Narrower Beam

A consistent, incorrect level reading may result due to interference echoes from the sides of a vessel. If this occurs, try installing a longer range (narrower beam) transducer, enter the new *2.1.6. Transducer* model, and (if necessary) optimize aiming and frequency again.

Always contact Siemens service personnel before selecting a transducer to solve this type of problem.

Fixed Reading

If the Reading is a fixed value, regardless of the transducer to material surface distance, ensure the:

1. Transducer acoustic beam is free from obstruction.
2. Transducer is properly aimed
3. Transducer is not in contact with any metal object.
4. Material mixer (if used) is operating while the SITRANS LUT400 is operating. If it is stopped, ensure that the mixer blade is not stopped under the transducer.

Obstructions in the Sound Beam

Check for (and remove if present) any acoustic beam obstruction, or relocate the transducer.

If an obstruction cannot be removed or avoided, adjust the Time Varying Threshold (TVT) curve to reduce the Echo Confidence derived from the sound reflected by the obstruction. Use SIMATIC PDM to adjust the TVT curve. (See *TVT Shaper* under *Echo Profile Utilities* in LUT400 Communications manual¹.)

Nozzle Mountings

If the transducer is mounted on or in a nozzle, grind smooth any burrs or welds on the inside or open end (the end that opens into the vessel). If the problem persists, install a larger diameter or shorter length nozzle, bevel the inside of the bottom end, or cut the open end of the nozzle at a 45° angle.

See the transducer manual for complete mounting instructions.

If the mounting hardware is over tightened, loosen it. Over tightening changes the resonance characteristics of the transducer and can cause problems.

¹ Communications for SITRANS LUT400 (HART) Manual (7ML19985NE01)

Set the SITRANS LUT400 to Ignore the Bad Echo

If the preceding remedies have not fixed the problem, the false echo has to be ignored.

If the Echo is Close to the Transducer

If there is a static, incorrect, high level reading from the SITRANS LUT400 there is probably something reflecting a strong echo back to the transducer. If the material level never reaches that point extend the *2.2.4. Near Range* to a distance to just past the obstruction.

Adjust the TVT to Ignore the Echo

Use *2.12.3.1. Auto False Echo Suppression*. If this does not correct the problem, use *2.12.4. TVT Shaper* to manually shape around false echoes.

Wrong Reading

If the Reading is erratic, or jumps to some incorrect value periodically, ensure the:

1. Surface monitored is not beyond the SITRANS LUT400's programmed range or the transducer's maximum range.
2. Material is not falling into the transducer's acoustic beam.
3. Material is not inside the blanking distance (near range) of the transducer.

Types of Wrong Readings

If a periodic wrong Reading is always the same value, see "Fixed Reading" on page 243.

If the wrong Reading is random, ensure the distance from the transducer to the material surface is less than *2.2.5. Far Range* value plus one meter (i.e. ensure you are still within the measurement range programmed in the device). If the material/object monitored is outside this range, increase *2.2.5. Far Range* as required. This error is most common in OCM applications using weirs.

Liquid Splashing

If the material monitored is a liquid, check for splashing in the vessel. Enter a lower *Response Rate* value (see page 42) to stabilize the Reading, or install a stilling well. (Contact Siemens representative.)

Adjust the Echo Algorithm

Use SIMATIC PDM to view echo profiles and make adjustments to the *Algorithm* parameter. See *2.12.2.1. Algorithm* on page 181 for details.

If the "TRACKER" algorithm is used and narrow noise spikes are evident on the Echo Profile, widen the *2.12.2.4. Narrow Echo Filter*. Also, if the true echo has jagged peaks, use *2.12.2.3. Reform Echo*.

If multiple echoes appear on the Echo Profile, typical of a flat material profile (especially if the vessel top is domed), use the "TF" (True First) algorithm.

Should a stable measurement still not be attainable, contact Siemens representative.

Transducer Ringing

If the transducer is mounted too tightly, or if it is mounted so that its side touches something (such as a vessel wall, or standpipe), its resonance characteristics change and this can cause problems. Hand tighten only. PTFE tape is not recommended as it reduces friction resulting in a tighter connection that can lead to ringing.

Normal Ring Down

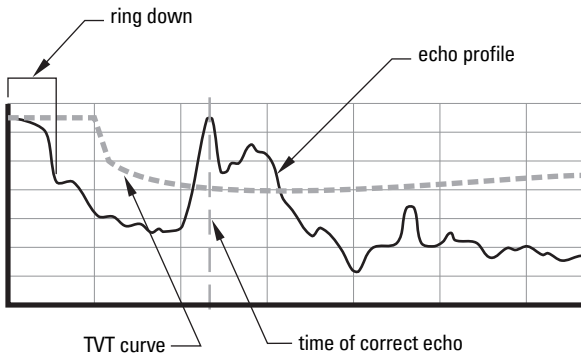

Poor Ring Down

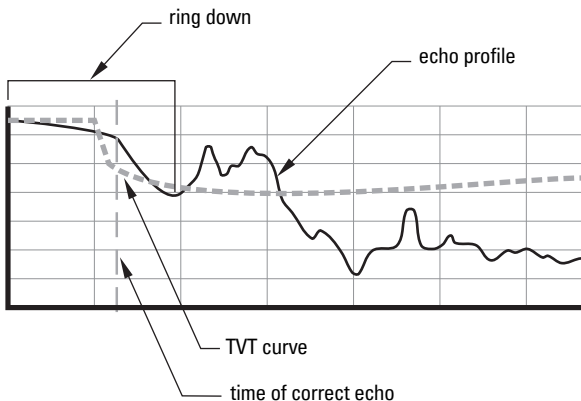

Ring down times that extend past the near range area can be interpreted by the SITRANS LUT400 as the material level and are characterized by a steady high level being reported.

Echo Profile Display

To assist in troubleshooting echo profiles, **pan** and **zoom** options are available. See "Requesting an Echo Profile" on page 57.

Trend Display

A trend display is available with pan and zoom options. See "Trends" on page 118.

Notes

Technical Data

Power

AC model

- 100-230 V AC $\pm 15\%$, 50 / 60 Hz, 36 VA (10W)¹
- Fuse: 5 x 20 mm, Slow Blow, 0.25A, 250V

DC model

- 10-32 V DC, 10W¹
- Fuse: 5 x 20 mm, Slow Blow, 1.6A, 125V

Performance

Range

- 0.3 to 60 m (1 to 196 ft), dependent on transducer

Accuracy (measured under Reference Conditions similar to IEC 60770-1)

- Standard operation: ± 1 mm (0.04") plus 0.17 % of distance
- High accuracy OCM²: ± 1 mm (0.04"), within 3 m (9.84 ft) range

Resolution (measured under Reference Conditions similar to IEC 60770-1)

- Standard operation: 0.1 % of range or 2 mm (0.08"), whichever is greater
- High accuracy OCM²: 0.6 mm (0.02"), within 3 m (9.84 ft) range

Reference operating conditions according to IEC 60770-1

- ambient temperature +15 to +25 °C (+59 to +77 °F)
- humidity 45% to 75% relative humidity
- ambient pressure 860 to 1060 mbar g (86 000 to 106 000 N/m² g)

Temperature Compensation

- Range: -40 to +150 °C (-40 to +300 °F)

¹ Power consumption is listed at maximum.

² A high accuracy configuration consists of the LUT440 (OCM) model using XRS-5 transducer, TS-3 temperature sensor, and a Low Calibration Point of 3 m or less.
Under severe EMI/EMC environments per IEC 61326-1 the DC powered device may have an additional error increase of up to 0.5 mm.

Source

- Integral transducer sensor
- TS-3 temperature sensor
- Average (integral transducer and TS-3)
- Programmable fixed temperature

Temperature Error

Fixed

- 0.17 % per °C deviation from programmed value

Memory

- 512 kB flash EPROM
- 1.5 MB flash for data logging

Interface

Outputs

Transducer drive

- 315 V peak

mA Analog

- 4-20 mA
- 600 ohms maximum in ACTIVE mode, 750 ohms maximum in PASSIVE mode
- Resolution of 0.1%
- Isolated

Relays¹ (3)

- 2 control
- 1 alarm control

Control Relays

- 2 Form **A (SPST), NO** relays
- Rated 5A at 250 V AC, non-inductive
- Rated 3A at 30 V DC

¹ All relays are certified only for use with equipment that fails in a state at or under the rated maximums of the relays.

Alarm Relay

- 1 Form **C (SPDT), NO** or **NC** relay
- Rated 1A at 250 V AC, non-inductive
- Rated 3A at 30 V DC

Inputs

Discrete (2)

- 0-50 V DC maximum switching level
- Logical 0 = < 10 V DC
- Logical 1 = 10 to 50 V DC
- 3 mA maximum draw

Programming

Primary

- Local push buttons

Secondary

- PC running SIMATIC PDM
- PC running Emerson AMS Device Manager
- PC running a web browser
- PC running a Field Device Tool (FDT)
- Field Communicator 375/475 (FC375/FC475)

Compatible Transducers

- EchoMax series and STH series

Transducer Frequency

- 10 to 52 kHz

Communication

- HART 7.0
- USB

Display

- Back-lit LCD
- Dimensions:
 - 60 x 40 mm (2.36 x 1.57")
- Resolution:
 - 240 x 160 pixels
- Removable display, operational up to 5 m from enclosure base

Mechanical

Enclosure

- 144 mm (5.7") x 144 mm (5.7") x 146 mm (5.75")
- IP65 / Type 4X / NEMA 4X
- Polycarbonate

Note: Use only approved, suitable size hubs in the enclosure's conduit holes that maintain the applicable IP / Type / NEMA rating.

Remote Display Lid

- 144 mm (5.7") x 144 mm (5.7") x 22 mm (0.87")
- IP65 / Type 3 / NEMA 3
- Polycarbonate
- Operational up to 5 m from enclosure base

Blank Lid

- 144 mm (5.7") x 144 mm (5.7") x 22 mm (0.87")
- IP65 / Type 4X / NEMA 4X
- Polycarbonate



WARNINGS:

- Ingress protection of the enclosure is reduced to IP20, and Type 4X / NEMA 4X rating is void when cable entry knock-out in the blank lid is removed.
- An enclosure reduced to an IP20 rating and intended for use in non-hazardous locations must be installed in an indoor location free of dust and moisture, or be installed in a suitable rated field enclosure IP54 or better.

Back Mount Bracket

- 190 mm (7.5") x 190 mm (7.5") x 9 mm (0.35")
- Polycarbonate

Weight

- Enclosure with display lid: 1.3 kg (2.87 lbs)
- Enclosure with blank lid: 1.2 kg (2.65 lbs)

Environmental

Location

- Indoor / outdoor
(only suitable for outdoor use with IP65 / Type 4X / NEMA 4X Enclosure)

Altitude

- 2000 m max.

Ambient temperature

- -20 to +50 °C (-4 to +122 °F)

Relative humidity

- Suitable for outdoors
(only with IP65 / Type 4X / NEMA 4X Enclosure)

Installation category

- II

Pollution degree

- 4

Approvals

Note: The device nameplate lists the approvals that apply to your device.

- General
CSA_{US/C}, CE, FM, UL listed, C-TICK
- Hazardous
Non-incendive (Canada) CSA Class I, Div. 2, Groups A, B, C, D; Class II,
Div 2, Groups F, G; Class III

Notes

Dimension Drawings

SITRANS LUT400 Dimensions

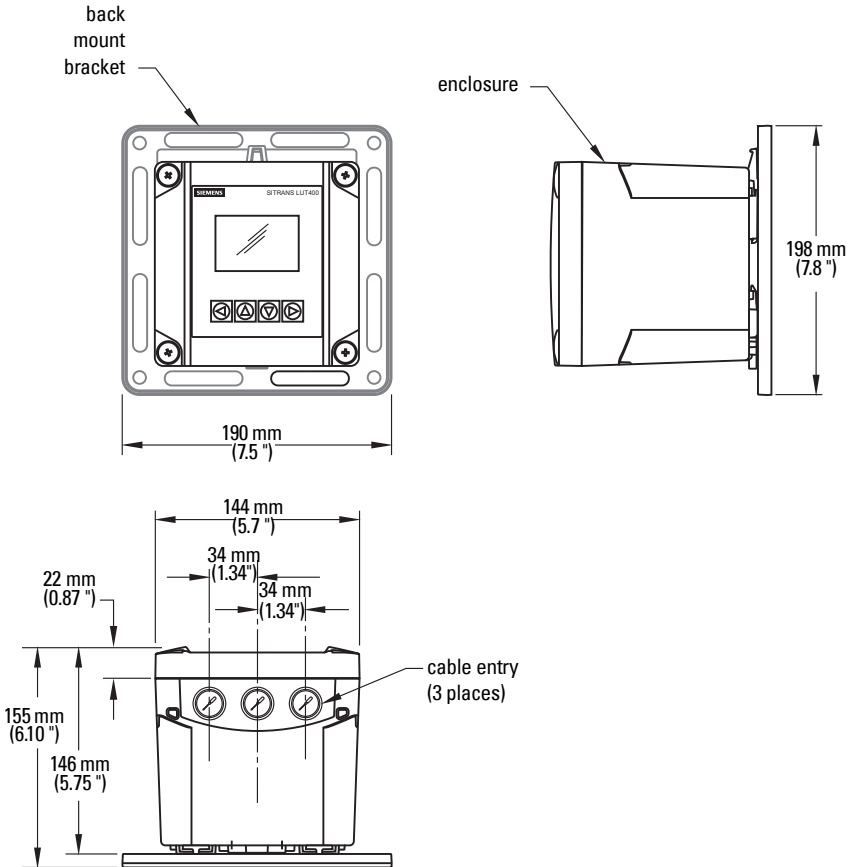

Appendix A - Technical Reference

Note: Where a number precedes a parameter name (for example, *2.12.2.4. Narrow Echo Filter*) this is the parameter access number via the local display. See *Parameter reference (LU)* on page 137 for a complete list of parameters.

Principles of Operation

The SITRANS LUT400 is a high quality ultrasonic controller, configured to meet the needs of different applications, from medium range solids applications to liquids management with open channel measurement capability. The LUT400 features our next generation of Sonic Intelligence[®] advanced echo-processing software for increased reading reliability.

Process Variables

The Primary Variable (PV) is one of six process variables, and is set in *2.5.1.Current Output Function*.

- Level (difference between material level and Low Calibration Point),
- Space (difference between material level and High Calibration Point),
- Distance (difference between material level and sensor reference point),
- Head (difference between liquid level and Zero Head),
- Volume (volume of material based on level),
- Flow (flowrate in an open channel, based on head).

Transmit Pulse

The transmit pulse consists of one or more electrical “shot” pulses, which are supplied to the transducer connected to the SITRANS LUT400 terminals. The transducer fires an acoustic “shot” for each electrical pulse supplied. After each shot is fired, sufficient time is provided for echo (shot reflection) reception before the next (if applicable) shot is fired. After all shots of the transmit pulse are fired, the resultant echoes are processed. The transmit pulse frequency, duration, delay, and associated measurement range are defined by parameters in the Setup menu (see *Setup* on page 138.)

Echo Processing

SITRANS LUT400 uses next generation Sonic Intelligence[®] for echo processing.

Next generation Sonic Intelligence provides adaptive digital filtering of the transducer signal. For example, when noise levels are high, filters are adjusted to maximize the signal to noise ratio. This advanced Sonic Intelligence not only allows for better filtering, but provides improved tracking of echos, and more sophisticated echo positioning algorithms.

Echo processing consists of echo enhancement, true echo selection, and selected echo verification.

Echo enhancement is achieved by filtering (*2.12.2.4. Narrow Echo Filter*) and reforming (*2.12.2.3. Reform Echo*) the echo profile.

True echo selection (selection of echo reflected by the intended target) occurs when that portion of the echo profile meets the evaluation criteria of Sonic Intelligence.

Insignificant portions of the echo profile outside of the measurement range (2.2.1. *Low Calibration Point*), below the TVT curve (2.12.4. *TVT Shaper*) are automatically disregarded. The remaining portions of the Echo Profile are evaluated using the echo select algorithm (2.12.2.1. *Algorithm*), and the Echo Profile portion providing the best echo confidence (3.2.9.2. *Confidence*) is selected.

A confidence value is a static test of a single snapshot profile so to maintain a valid reading, it imposes that each individual profile show its peak above the threshold. The window may be locked on the profile for hours or days so if the profile drops below the TVT curve just once, a loss of echo may occur.

The SITRANS LUT400, with its advanced tracking ability, can find and track the real echo amongst stationary clutter echoes. Therefore, even if the echo drops below the tvt curve, it can be identified with near certainty for approximately 30 seconds. This capability is measured by the FOM (3.2.9.1. *Figure of Merit*).

Selected echo verification is automatic. The position (relation in time after transmit) of the new echo is compared to that of the previously accepted echo. When the new echo is within the Echo Lock Window, it is accepted and displays, outputs, and relays are updated. If the new echo is outside of the Window, it is not accepted until Echo Lock requirements are satisfied.

Echo Selection

Time Varying Threshold (TVT)

A TVT curve describes a threshold below which any echoes will be ignored. The default TVT curve is used, until 2.12.3.1. *Auto False Echo Suppression* and 2.12.3.2. *Auto False Echo Suppression Range* are used to create a new 'learned TVT curve'.

A TVT hovers above the echo profile to screen out unwanted reflections (false echoes).

In most cases the material echo is the only one which rises above the default TVT.

In a vessel with obstructions, a false echo may occur. See *Shaper Mode and Auto False Echo Suppression* below for more details.

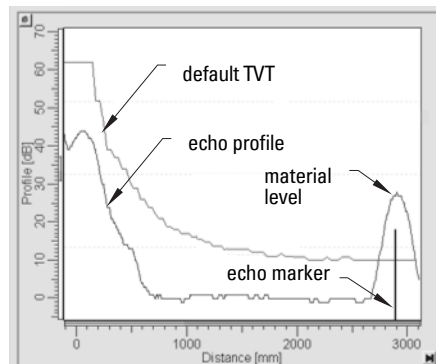

The device characterizes all echoes that rise above the TVT as potential good echoes. Each peak is assigned a rating based on its strength, area, height above the TVT, and reliability, amongst other characteristics.

Algorithm

The true echo is selected based on the setting for the Echo selection algorithm. For a list of options see **Algorithm (2.12.2.1)** on page 181. All algorithms ultimately use confidence to select the true echo. However, when applications report a low confidence value, the **TR** algorithm (which tracks the moving echo) can be used to predict the primary variable.

Algorithm		Echo Determination	Suggested Usage
TF	True First echo	Selects the first echo that crosses TVT curve.	Use in liquids applications free of obstructions when confidence of first echo is high.
TR	TR acker	Selects the echo that is closest to the transducer, and is moving. (If echo location is steady, BLF algorithm should be used.)	Only use TR algorithm in process applications with continuous level changes, and a risk of fixed obstructions that could interfere with true level, resulting in low confidence.
L	Largest echo	Selects the largest echo above the TVT curve.	Use in long range liquids applications with large (tall) material return echoes.
BLF	Best of First and Largest echo	Selects the echo (first and highest) with the highest confidence value.	Default and most commonly used. Use in all short to mid range general liquids and solids applications where there is a relatively large (tall), sharp echo.
ALF	Area, Largest, and First	Selects the echo with the highest confidence value based on the three criterion (widest, highest, and first).	Use in mid to long range solids applications where the material return echo is wide and large, and where competing smaller echoes challenge BLF

Confidence

Confidence (3.2.9.2) describes the quality of an echo. Higher values represent higher quality.

Echo Threshold

Echo Threshold (2.12.2.2) defines the minimum confidence value required for an echo to be accepted as valid and evaluated.

Figure of Merit

Figure of Merit (3.2.9.1.) measures the quality of the reported process value: higher values represent better quality. Even when a low confidence value exists, a high FOM will ensure the true echo has been selected. Approximately 20 readings are used to support the FOM value.

Example:

FOM greater than 75% = good quality,

FOM less than 50% = poor quality.

Various things contribute to the FOM:

- success of the tracking (how closely can the next level vs. the actual next level be predicted)
- level of noise
- confidence of the last echo
- time interval since last valid echo
- speed at which the process is moving
- quality of the echo shape and how it helps the calculation of the echo position

If FOM is low, reduce the noise in the process, or check the installation to increase signal quality.

Shaper Mode and Auto False Echo Suppression

Notes:

- For detailed instructions on using this feature via PDM, see Auto False Echo Suppression in LUT400 Communications manual^a.
- For detailed instructions on using this feature via the local push buttons, see **Shaper Mode (2.12.3.4.)** on page 184.

^a. Communications for SITRANS LUT400 (HART) Manual (7ML19985NE01)

False echoes can be caused by an obstruction in the transducer shot path (such as pipes, ladders, chains). Such false echoes may rise above the default TVT curve.

Auto False Echo Suppression Range (2.12.3.2.) specifies the range within which the learned TVT is applied. Default TVT is applied over the remainder of the range.

The material level should be below all known obstructions at the moment when Auto False Echo Suppression learns the echo profile. Ideally the vessel should be empty or almost empty.

The device learns the echo profile over the whole measurement range and the TVT is shaped around all echoes present at that moment.

Auto False Echo Suppression Range must be set to a distance shorter than the distance to the material level when the environment was learned, to avoid the material echo being screened out.

Example before Auto False Echo Suppression

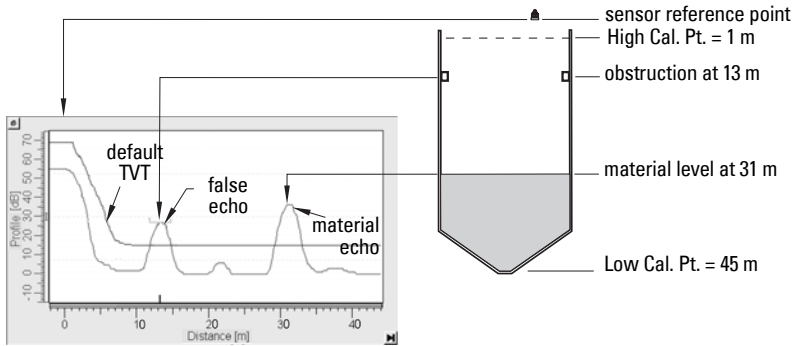

Example after Auto False Echo Suppression

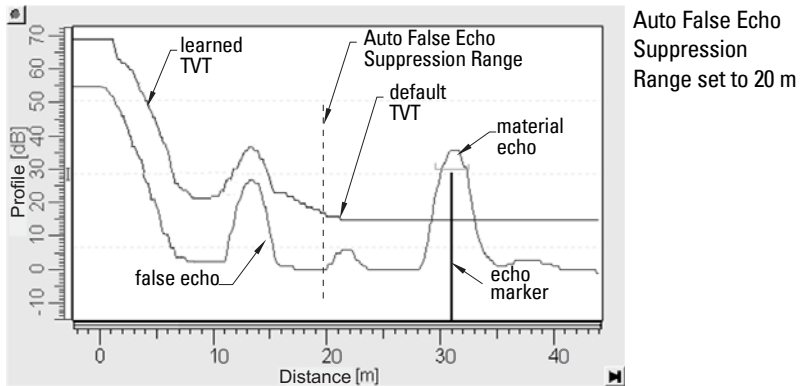

Measurement Range

Near Range

Near Range (2.2.4.) programs SITRANS LUT400 to ignore the area in front of the transducer. The default blanking distance is 27.8 cm (0.91 ft) from the sensor reference point.

Near Range allows you to increase the blanking value from its factory default. But Shaper Mode (2.12.3.4.) is generally recommended in preference to extending the blanking distance from factory values.

Far Range

Far Range (2.2.5.) can be used in applications where the base of the vessel is conical or parabolic. A reliable echo may be available below the vessel empty distance, due to an indirect reflection path.

Increasing Far Range by 30% or 40% can provide stable empty vessel readings.

Measurement Response

Note: Units are defined in **Quick Start (11.)** and are in meters by default.

Response Rate limits the maximum rate at which the display and output respond to changes in the measurement. There are three preset options: slow, medium, and fast.

Once the real process fill/empty rate (m/min by default) is established, a response rate can be selected that is slightly higher than the application rate. Response Rate automatically adjusts the three rate parameters that affect the output response rate.

When Response Rate set to:	Fill Rate per Minute (2.3.1.)/ Empty Rate per Minute (2.3.2.) automatically adjust to:	Damping Filter (2.3.3.) automatically adjusts to:	
*	Slow	0.1 m/min	100.0 s
	Medium	1.0 m/min	10.0 s
	Fast	10.0 m/min	0.0 s

Damping

Damping Filter (2.2.3.) smooths out the response to a sudden change in level. This is an exponential filter and the engineering unit is always in seconds.

In 5 time constants, the output rises exponentially: from 63.2% of the change in the first time constant, to almost 100% of the change by the end of the 5th time constant.

Damping example

time constant = 2 seconds
input (level) change = 2 m

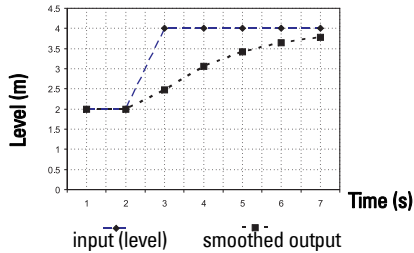

Note: Damping Filter can be set to 0 in order to display measurement readings as fast as fill/empty rates permit. Fill Rate per Minute, and Empty Rate per Minute work in conjunction with Damping Filter, therefore, if readings are slow to respond to changes, check that Fill and Empty Rates are set to values greater than or equal to the desired Response Rate.

Analog Output

The mA output (current output) is proportional to material level in the range 4 to 20 mA. 0% and 100% are percentages of the full-scale reading (m, cm, mm, ft, in). Typically mA output is set so that 4 mA equals 0% and 20 mA equals 100%.

Current Output Function (2.6.1.)

Current Output Function (2.6.1.) controls the mA output and applies any relevant scaling. By default it is set to **LEVEL**. Other options are Space, Distance, Volume, Head, Flow, or Manual. A **MANUAL** setting allows you to test the functioning of the loop.

You can also set the mA output to report when the device is in an error condition and the fail-safe timer has expired. By default, the reported value depends on the device type. A standard device reports the last valid reading, and a NAMUR NE43 compliant device reports the user-defined value for **Material Level** (3.58 mA by default).

Loss of Echo (LOE)

A loss of echo (LOE) occurs when the calculated measurement is judged to be unreliable because the echo confidence value has dropped below the echo confidence threshold.

If the LOE condition persists beyond the time limit set in **LOE Timer (2.4.2.)** the LCD displays the Service Required icon, and the text region displays the fault code 0 and the text LOE.

If two faults are present at the same time, the device status indicator and text for the highest priority fault will display. For example, if both Loss of Echo and Broken cable faults are present, the Broken cable fault will display.



1 Broken cable

Fail-safe Mode

The purpose of the Fail-safe setting is to put the process into a safe mode of operation in the event of a fault or failure. The value to be reported in the event of a fault (as displayed in *2.5.8. Current Output Value*) is selected so that a loss of power or loss of signal triggers the same response as an unsafe level.

LOE Timer (2.4.2.) determines the length of time a Loss of Echo (LOE) condition will persist before a Fail-safe state is activated. The default setting is 100 seconds.

Material Level (2.4.1.) determines the mA value (corresponding to the selected PV) to be reported when **LOE Timer (2.4.2.)** expires. The default setting is device dependent (standard or NAMUR NE 43-compliant).

Upon receiving a reliable echo, the loss of echo condition is aborted, the Maintenance Required icon and error message are cleared, and the mA output return to the current material level. [The PV region on the LUI display will show dashes (-----) when a fault that causes fail-safe is present, and will return to the current reading when the fault is cleared.]

Distance Calculation

To calculate the transducer to material level (object) distance, the transmission medium (atmosphere) *2.12.1.1. Sound Velocity* is multiplied by the acoustic transmission to reception time period. This result is divided by 2 to calculate the one way distance.

$$\text{Distance} = \text{Sound Velocity} \times \text{Time} / 2$$

The Reading displayed is the result of performing any additional modification to the calculated distance as determined by:

- *2.1.2. Sensor Mode,*
- *2.1.1. Units,*
- Volume conversion parameters - *2.6. Volume, 2.2.3. Sensor Offset,*
- Flow parameters - *2.15. Flow,*
- and/or Totalizer parameters - *2.16. Totalizers.*

Sound Velocity

The sound velocity of the transmission medium is affected by the type, temperature, and vapor pressure of the gas or vapor present. As preset, the SITRANS LUT400 assumes the vessel atmosphere is air at +20 °C (+68 °F). Unless altered, the sound velocity used for the distance calculation is 344.1 m / s (1129 ft / s).

Variable air temperature is automatically compensated when a Siemens ultrasonic / temperature transducer is used. If the transducer is exposed to direct sunlight, use a sunshield or a separate TS-3 temperature sensor.

Also, if the temperature varies between the transducer face and the liquid monitored, use a TS-3 temperature sensor in combination with an ultrasonic / temperature transducer. The TS-3 must be installed as close to the material as possible to ensure best performance. It is acceptable to submerge the TS-3 if necessary. Set *2.12.1.3. Temperature Source* for **Average of Sensors**, to average the transducer and TS-3 measurements.

Atmosphere composition other than air can pose a challenge for ultrasonic level measurement. However, excellent results may be obtained if the atmosphere is homogeneous (well mixed), at a fixed temperature, and consistent vapour pressure, by performing a *2.12.1.6. Auto Sound Velocity*.

The SITRANS LUT400 automatic temperature compensation is based on the sound velocity / temperature characteristics of "air" and may not be suitable for the atmosphere present. If the atmosphere temperature is variable, perform frequent sound velocity calibrations to optimize measurement accuracy.

Sound velocity calibration frequency may be determined with experience. If the sound velocity in two or more vessels is always similar, future calibrations may be performed on one vessel and the resultant *2.12.1.1. Sound Velocity* entered directly for the other vessel(s).

If the sound velocity of a vessel atmosphere is found to be repeatable at specific temperatures, a chart or curve may be developed. Then rather than performing a sound velocity calibration each time the vessel temperature changes significantly, the anticipated *2.12.1.1. Sound Velocity* may be entered directly.

Volume Calculation

The SITRANS LUT400 provides a variety of volume calculation features (see *2.6. Volume*).

If the vessel does not match any of the eight preset vessel shape calculations, a Universal Volume calculation may be used. Use the level/volume graph or chart provided by the vessel fabricator (or create one based on the vessel dimensions). Based on the graph, choose the Universal Volume calculation, and select the level vs. volume breakpoints to be entered (32 max). Generally, the more breakpoints entered, the greater the accuracy.

2.6.1. Vessel Shape set to Universal, Linear

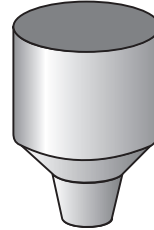
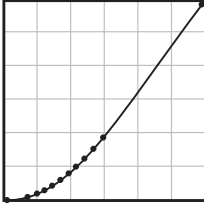

This volume calculation creates a piece-wise linear approximation of the level/volume curve. This option provides best results if the curve has sharp angles joining relatively linear sections.

Enter a Level Breakpoint at each point where the level/volume curve bends sharply (2 minimum).

For combination curves (mostly linear but include one or more arcs), enter numerous breakpoints along the arc, for best volume calculation accuracy.

2.6.1. Vessel Shape set to Universal, Curved

This calculation creates a cubic spline approximation of the level/volume curve, providing best results if the curve is non-linear, and there are no sharp angles.

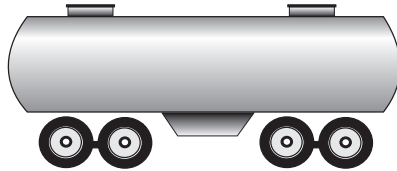
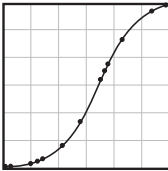

Select at least enough breakpoints from the curve to satisfy the following:

- two breakpoints very near the minimum level
- one breakpoint at the tangent points of each arc
- one breakpoint at each arc apex
- two breakpoints very near the maximum level

For combination curves, enter at least two breakpoints immediately before and after any sharp angle (as well as one breakpoint exactly at the angle) on the curve.

Pump Totalizers

Inflow/Discharge Adjust

Pumped volume totals are affected by the inflow (or discharge) rate. This rate can be calculated based on rate of change estimation, or pump cycle timing.

Using **Inflow/Discharge Adjust (2.73.4.)**, set option **Based on rate estimation** to have the inflow rate measured just prior to the start of the pump cycle.

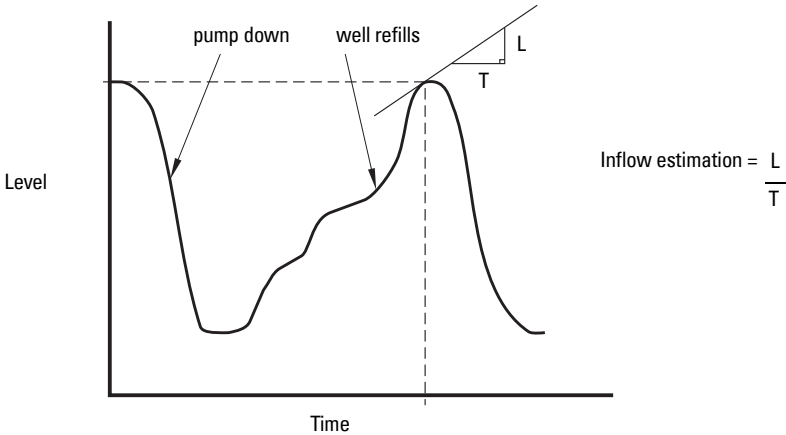

Set option **Based on pump cycle** to calculate the inflow based on the change of volume between the end of the last pump cycle and the start of the next one, and the time period between the last cycle and the current one.

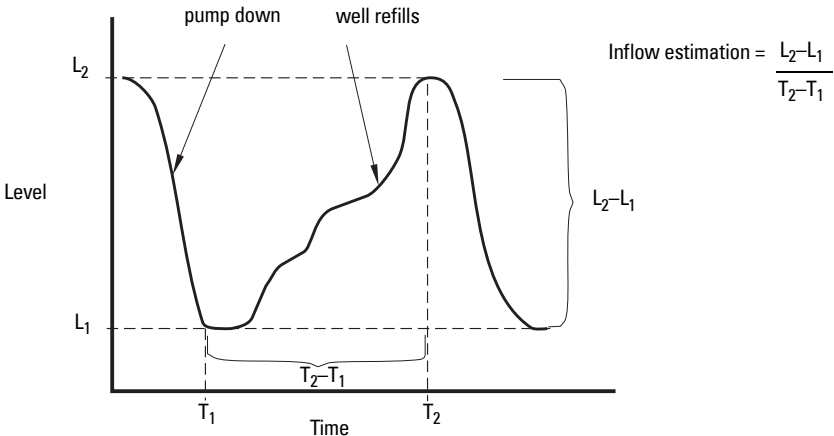

Flow Calculation

Special emphasis has been placed on providing the most accurate flow calculations possible. To this end, specific routines have been written to comply with the British Standards Institute's Specifications BS-3680. These routines calculate correction factors taking into account second order effects such as approach velocity and boundary layer.

If the PMD does not match any of the eleven preset PMD calculations, or if a PMD is not used, select a Universal flow calculation (PMD = Universal Head Flow). Use the head/flow graph or chart provided by the PMD fabricator (or create one based on the PMD or channel dimensions).

The SITRANS LUT400 supports Universal curved flow calculation. This calculation creates a cubic spline approximation of the head/flow curve, providing best results if the curve is non-linear, and there are no sharp angles.

Select the head versus flow breakpoints to be entered (32 max). Generally, the more breakpoints entered, the greater the flow calculation accuracy.

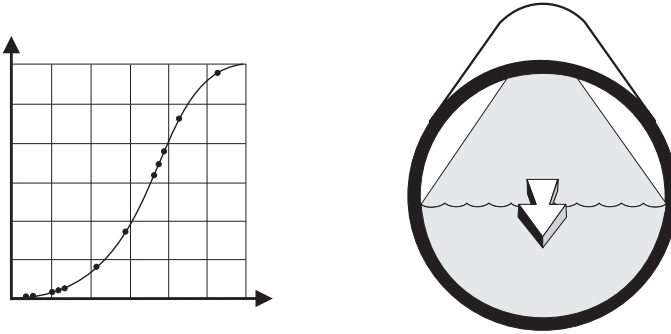

Select at least enough breakpoints from the curve to satisfy the following:

- two breakpoints very near the minimum head
- one breakpoint at the tangent points of each arc
- one breakpoint at each arc apex
- two breakpoints very near the maximum head

For combination curves, enter at least 2 breakpoints immediately before and after any sharp angle (as well as 1 breakpoint exactly at the angle) on the curve.

Method of Flow Calculation

The SITRANS LUT400 can be programmed to use either of two methods for calculating flow from the head measurement: absolute or ratiometric. The result is the same regardless of the method used. The main difference is the information that must be entered in order for the device to carry out the calculation. Refer to 2.15.1. *Primary Measuring Device (PMD)*, and 2.15.4. *PMD Dimensions* for list of information required.

For the ratiometric method, it is usually sufficient that the user know the flow rate (Q_{cal}) which occurs at maximum head (h_{cal}).

On the other hand, absolute calculations require that the user enter information such as: the physical dimensions of the PMD and the constant relating to units of measure for both linear dimensions and flow rates.

Example:

the general formula for flow through a single exponent PMD is:

$$Q = KH^x$$

the specific formula for flow through a 45 ° V-notch weir is:

$$cfs = 1.03H^{2.5}$$

thus: Q = flow in cubic feet per second

K = constant of 1.03

H = head in feet

The absolute method is not applicable to the following:

- Palmer Bowls Flume
- H-Flume

Data Logging

Data logs are available for Alarms, OCM flow, Daily Totals, and Primary Variable. The logs can be examined locally via LUI (see **View Logs (3.2.6.)**), or via USB on a computer.

After connecting the USB cable, browse to the USB drive on the computer. Logs can be viewed on the USB drive, or can be copied from the USB drive to another local computer drive.

Note: No data logs are written while device is connected to a PC via USB.

Log files written to a local computer drive via USB, are comma-delimited files, and a list of file headings for each type of log is shown below.

Log type	Headings
Alarms	Current Date (YYYY/MM/DD)
	Current Time (HH:MM:SS)
	Alarm Name
	Alarm Value
	Alarm State
OCM	Current Date (YYYY/MM/DD)
	Current Time (HH:MM:SS)
	Current Head Value (in level units)
	Current Flow Value (in flowrate units)
Daily Totals	Current Date (YYYY/MM/DD)
	Maximum Daily Flow (in flowrate units)
	Minimum Daily Flow (in flowrate units)
	Daily Average Flow (in flowrate units)
	Daily Totalized Volume (in volume units)
	Daily Running Totalized Volume (in volume units)
	Daily Maximum Temperature (in temperature units)
	Daily Minimum Temperature (in temperature units)
PV	Current Date (YYYY/MM/DD)
	Current Time (HH:MM:SS)
	PV (in Device Variable Code) 0 = Level 1 = Space 2 = Distance 3 = Volume 4 = Flow 5 = Head
	PV Value (in PV units)
	Temperature Value (in temperature units)

To clear entries when log memory becomes full, see *Viewing the Data Log* on page 119.

Notes

Appendix B - Certificates and Support

Certificates

Certificates can be downloaded from the product page of our website at:
www.siemens.com/sitransLUT400.

Technical Support

If you have any technical questions about the device described in these Operating Instructions and do not find the answers, you can contact Customer Support:

- Via the Internet using the **Support Request**:
Support request (<http://www.siemens.com/automation/support-request>)
- Via Phone:
 - Europe: +49 (0) 911 895 7222
 - America: +1 423 262 5710
 - Asia-Pacific: +86 10 6475 7575

Further information about our technical support is available on the Internet at
Technical support (<http://support.automation.siemens.com/WWW/view/en/16604318>)

Service & Support on the Internet

In addition to our documentation, we offer a comprehensive knowledge base online on the Internet at:

Service & Support (<http://www.siemens.com/automation/service&support>)

There you will find:

- The latest product information, FAQs, downloads, tips and tricks.
- Our newsletter, providing you with the latest information about our products.
- Our bulletin board, where users and specialists share their knowledge worldwide.
- Your local contact partner for Industry Automation and Drives Technologies in our partner database.
- Information about field service, repairs, spare parts and lots more under "Services".

Additional Support

Please contact your local Siemens representative and offices if you have additional questions about the device.

Find your contact partner at:

Local contact person (<http://www.siemens.com/automation/partner>)

Notes

List of Abbreviations

Short form	Long Form	Description	Units
AC	Alternating Current	power source	
AFES	Auto False Echo Suppression		
CE / FM / CSA	Conformité Européene / Factory Mutual / Canadian Standards Association	safety approval	
BS-3680	Flow standard from the British Standards Institute		
DC	Direct Current	power source	
DTM	Device Type Manager		
EDD	Electronic Device Description		
EMC	Electromagnetic Compatibility		
ESD	Electrostatic Discharge		
FCC	Federal Communications Commission		
FDT	Field Device Tool		
FOM	Figure of Merit	measurement of echo quality	
HART	Highway Addressable Remote Transducer		
HCF	Hart Communication Foundation		
IEC	International Electrotechnical Commission		
IP	Ingress Protection		
IS	Intrinsically Safe	safety approval	
LCD	Liquid Crystal Display		
LOE	Loss of Echo		
LUI	Local User Interface	view outputs via LCD display; make modifications via local push buttons	
μs	microsecond	10^{-6}	Second
μV	microvolt	10^{-6}	Volt
mA	Milliamp	unit of electric current	
N m	Newton meter	unit of torque	

Short form	Long Form	Description	Units
NEMA	National Electrical Manufacturer's Association		
PDM	Process Device Manager		
PLC	Programmable Logic Controller		
PV	Primary Variable	measured value	
RC	Resistance Capacitance	resistance x capacitance	μs
SCADA	Supervisory Control and Data Acquisition		
SCR	Silicon-controlled rectifier	switching device	
SPDT	Single Pole Double Throw	relay configuration	
SPST	Single Pole Single Throw	relay configuration	
SV	Secondary Variable	equivalent value	
TVT	Time Varying Threshold	sensitivity threshold	
USB	Universal Serial Bus		
VSDs	Variable Speed Drives		

LCD Menu Structure

LCD Menu Structure



Notes:

- In Navigation mode **ARROW keys** navigate the menu in the direction of the arrow.
- See *Parameter reference (LUI)* on page 137 for detailed information and instructions.

MAIN MENU

1. WIZARDS

1.1 QUICK START

1.1.1 QS LEVEL

- INTRODUCTION
- TRANSDUCER
- OPERATION
- TEMPERATURE SOURCE
- FIXED TEMPERATURE
- UNITS
- HIGH CALIB. PT.
- LOW CALIB. PT.
- RESPONSE RATE
- APPLY?

1.1.2 QS VOLUME

- INTRODUCTION
- TRANSDUCER
- TEMPERATURE SOURCE
- FIXED TEMPERATURE
- VESSEL SHAPE
- UNITS
- HIGH CALIB. PT.
- LOW CALIB. PT.
- RESPONSE RATE
- DIMENS. A
- DIMENS. L
- VOLUME UNITS
- MAX. VOLUME
- APPLY?

1.1.3 QS FLOW (LUT430, 440 only)

- INTRODUCTION
- TRANSDUCER
- TEMPERATURE SOURCE
- FIXED TEMPERATURE
- PRIMARY MEASURING DEVICE
- METHOD OF FLOW CALCULATION
- UNITS
- HIGH CALIB. PT.
- LOW CALIB. PT.
- RESPONSE RATE
- Calculation factors (vary per PMD)
- PMD dimensions (vary per PMD)
- MAXIMUM HEAD
- ZERO HEAD OFFSET
- FLOWRATE UNITS
- MAXIMUM FLOW AT 20MA
- FLOWRATE DECIMAL
- LOW FLOW CUTOFF
- APPLY?

1. WIZARDS (cont'd)

1.2 PUMP CONTROL

- INTRODUCTION
- NUMBER OF PUMPS
- RELAY PUMP 1
- RELAY PUMP 2
- PUMP CONTROL MODE
- SERVICE RATIO PUMP 1
- SERVICE RATIO PUMP 2
- RUN TIME PUMP 1
- RUN TIME PUMP 2
- ON SETPOINT PUMP 1
- ON SETPOINT PUMP 2
- OFF SETPOINT PUMP 1
- OFF SETPOINT PUMP 2

2. SETUP

2.1 SENSOR

- 2.1.1 UNITS
- 2.1.2 SENSOR MODE (LUT420)
- 2.1.3 SENSOR MODE (LUT430, 440)
- 2.1.4 SENSOR MODE SECONDARY (LUT420)
- 2.1.5 SENSOR MODE SECONDARY (LUT430, 440)
- 2.1.6 TRANSDUCER
- 2.1.7 FREQUENCY
- 2.1.8 LONG SHOT DURATION
- 2.1.9 SHORT SHOT DURATION

2.2 CALIBRATION

- 2.2.1 LOW CALIB. PT.
- 2.2.2 HIGH CALIB. PT.
- 2.2.3 SENSOR OFFSET
- 2.2.4 NEAR RANGE
- 2.2.5 FAR RANGE
- 2.2.6 AUTO SENSOR OFFSET

2.3 RATE

- 2.3.1 FILL RATE/MIN
- 2.3.2 EMPTY RATE/MIN
- 2.3.3 DAMPING FILTER

2.4 FAIL-SAFE

- 2.4.1 MATERIAL LEVEL
- 2.4.2 LOE TIMER
- 2.4.3 FAIL-SAFE MA VALUE

2.5 CURRENT OUTPUT

- 2.5.1 CURR. OUT. FUNC. (LUT420)
- 2.5.2 CURR. OUT. FUNC. (LUT430, 440)
- 2.5.3 4 MA SETPOINT
- 2.5.4 20 MA SETPOINT
- 2.5.5 MIN. MA LIMIT
- 2.5.6 MAX. MA LIMIT
- 2.5.7 MANUAL VALUE
- 2.5.8 CURRENT OUTPUT VALUE

2.6 VOLUME

- 2.6.1 VESSEL SHAPE
- 2.6.2 VOLUME UNITS
- 2.6.3 MAX. VOLUME
- 2.6.4 DIMENS. A
- 2.6.5 DIMENS. L
- 2.6.6 USER DEFINED UNIT

— 2. SETUP - VOLUME (cont'd)

- 2.6.7 TABLE 1-8
- 2.6.8 TABLE 9-16
- 2.6.9 TABLE 17-24
- 2.6.10 TABLE 25-32

2.7 PUMPS

2.7.1 BASIC SETUP

- 2.7.1.1 PUMP CONTROL ENABLE
- 2.7.1.2 RELAY PUMP 1
- 2.7.1.3 RELAY PUMP 2
- 2.7.1.4 PUMP CONTROL MODE (LUT420)
- 2.7.1.5 PUMP CONTROL MODE (LUT430, 440)
- 2.7.1.6 ON SETPOINT PUMP 1
- 2.7.1.7 OFF SETPOINT PUMP 1
- 2.7.1.8 ON SETPOINT PUMP 2
- 2.7.1.9 OFF SETPOINT PUMP 2
- 2.7.1.10 SERVICE RATIO PUMP 1
- 2.7.1.11 SERVICE RATIO PUMP 2

2.7.2 MODIFIERS

- 2.7.2.1 WALL CLING REDUCTION
 - 2.7.2.1.1 ENABLE
 - 2.7.2.1.2 LEVEL SETPOINT VARIATION
- 2.7.2.2 ENERGY SAVINGS (LUT430, 440 only)
 - 2.7.2.2.1 ENABLE
 - 2.7.2.2.2 PEAK LEAD TIME
 - 2.7.2.2.3 PEAK 1 START TIME
 - 2.7.2.2.4 PEAK 1 END TIME
 - 2.7.2.2.5 PEAK 2 START TIME
 - 2.7.2.2.6 PEAK 2 END TIME
 - 2.7.2.2.7 PEAK 3 START TIME
 - 2.7.2.2.8 PEAK 3 END TIME
 - 2.7.2.2.9 PEAK 4 START TIME
 - 2.7.2.2.10 PEAK 4 END TIME
 - 2.7.2.2.11 PEAK 5 START TIME
 - 2.7.2.2.12 PEAK 5 END TIME
 - 2.7.2.2.13 PEAK ON SETPOINT PUMP 1
 - 2.7.2.2.14 PEAK OFF SETPOINT PUMP 1
 - 2.7.2.2.15 PEAK ON SETPOINT PUMP 2
 - 2.7.2.2.16 PEAK OFF SETPOINT PUMP 2
- 2.7.2.3 PUMP RUN-ON (LUT430, 440 only)
 - 2.7.2.3.1 ENABLE
 - 2.7.2.3.2 RUN-ON INTERVAL
 - 2.7.2.3.3 RUN-ON DURATION PUMP 1
 - 2.7.2.3.4 RUN-ON DURATION PUMP 2
- 2.7.2.4 PUMP START DELAYS (LUT430, 440 only)
 - 2.7.2.4.1 DELAY BETWEEN STARTS
 - 2.7.2.4.2 POWER RESUMPTION DELAY

2.7.3 TOTALIZERS (LUT430, 440 only)

- 2.7.3.1 RUNNING TOTALIZER
- 2.7.3.2 TOTALIZER DECIMAL POSITION
- 2.7.3.3 TOTALIZER MULTIPLIER
- 2.7.3.4 INFLOW/DISCHARGE ADJUST
- 2.7.3.5 RESET RUNNING TOTALIZER

— 2. SETUP - ALARMS (cont'd)

2.8 ALARMS

2.8.1 HIGH LEVEL ALARM

- 2.8.1.1 ENABLE
- 2.8.1.2 HIGH LEVEL VALUE ON
- 2.8.1.3 HIGH LEVEL VALUE OFF
- 2.8.1.4 ASSIGNED RELAY
- 2.8.1.5 ALARM STATE

2.8.2 LOW LEVEL ALARM

- 2.8.2.1 ENABLE
- 2.8.2.2 LOW LEVEL VALUE ON
- 2.8.2.3 LOW LEVEL VALUE OFF
- 2.8.2.4 ASSIGNED RELAY
- 2.8.2.5 ALARM STATE

2.8.3 SWITCH (DI) ALARM

- 2.8.3.1 ENABLE
- 2.8.3.2 DISCRETE INPUT NUMBER
- 2.8.3.3 DISCRETE INPUT STATE
- 2.8.3.4 ASSIGNED RELAY
- 2.8.3.5 ALARM STATE

2.8.4 IN-BOUNDS LEVEL ALARM

- 2.8.4.1 ENABLE
- 2.8.4.2 HIGH LEVEL VALUE
- 2.8.4.3 LOW LEVEL VALUE
- 2.8.4.4 ASSIGNED RELAY
- 2.8.4.5 ALARM STATE

2.8.5 OUT-OF-BOUNDS LEVEL ALARM

- 2.8.5.1 ENABLE
- 2.8.5.2 HIGH LEVEL VALUE
- 2.8.5.3 LOW LEVEL VALUE
- 2.8.5.4 ASSIGNED RELAY
- 2.8.5.5 ALARM STATE

2.8.6 LOW TEMPERATURE ALARM

- 2.8.6.1 ENABLE
- 2.8.6.2 LOW TEMPERATURE VALUE ON
- 2.8.6.3 LOW TEMPERATURE VALUE OFF
- 2.8.6.4 ASSIGNED RELAY
- 2.8.6.5 ALARM STATE

2.8.7 HIGH TEMPERATURE ALARM

- 2.8.7.1 ENABLE
- 2.8.7.2 HIGH TEMPERATURE VALUE ON
- 2.8.7.3 HIGH TEMPERATURE VALUE OFF
- 2.8.7.4 ASSIGNED RELAY
- 2.8.7.5 ALARM STATE

2.8.8 FAIL-SAFE FAULT ALARM

- 2.8.8.1 ENABLE
- 2.8.8.2 ASSIGNED RELAY
- 2.8.8.3 ALARM STATE

2.8.9 HIGH FLOWRATE ALARM (LUT440 only)

- 2.8.9.1 ENABLE
- 2.8.9.2 HIGH FLOWRATE VALUE ON
- 2.8.9.3 HIGH FLOWRATE VALUE OFF
- 2.8.9.4 ASSIGNED RELAY
- 2.8.9.5 ALARM STATE

2. SETUP - ALARMS (cont'd)

- 2.8.10 LOW FLOWRATE ALARM (LUT440 only)
 - 2.8.10.1 ENABLE
 - 2.8.10.2 LOW FLOWRATE VALUE ON
 - 2.8.10.3 LOW FLOWRATE VALUE OFF
 - 2.8.10.4 ASSIGNED RELAY
 - 2.8.10.5 ALARM STATE
- 2.8.11 RELAY LOGIC
 - 2.8.11.1 RELAY 1 LOGIC
 - 2.8.11.2 RELAY 2 LOGIC
 - 2.8.11.3 RELAY 3 LOGIC
- 2.8.12 TIME TO SPILL
 - 2.8.12.1 LEVEL TO SPILL
 - 2.8.12.2 MINUTES LEFT TO SPILL
- 2.9 DISCRETE INPUTS
 - 2.9.1 BACKUP LEVEL OVERRIDE
 - 2.9.1.1 ENABLE
 - 2.9.1.2 LEVEL OVERRIDE VALUE
 - 2.9.1.3 DISCRETE INPUT NUMBER
 - 2.9.2 DISCRETE INPUT LOGIC
 - 2.9.2.1 DISCRETE INPUT 1 LOGIC
 - 2.9.2.2 DISCRETE INPUT 1 SCALED STATE
 - 2.9.2.3 DISCRETE INPUT 2 LOGIC
 - 2.9.2.4 DISCRETE INPUT 2 SCALED STATE
 - 2.9.3 PUMP INTERLOCK (LUT430, 440 only)
 - 2.9.3.1 ENABLE PUMP 1
 - 2.9.3.2 PUMP 1 DISCRETE INPUT
 - 2.9.3.3 ENABLE PUMP 2
 - 2.9.3.4 PUMP 2 DISCRETE INPUT
- 2.10 DATA LOGGING
 - 2.10.1 PROCESS VALUE LOG
 - 2.10.1.1 ENABLE
 - 2.10.1.2 PROCESS VALUES LOG RATE
 - 2.10.2 ALARM LOG
 - 2.10.2.1 ENABLE
 - 2.10.3 FLOW LOG (LUT430, 440 only)
 - 2.10.3.1 FLOW LOG MODE (LUT430)
 - 2.10.3.2 FLOW LOG MODE (LUT440)
 - 2.10.3.3 STANDARD FLOW LOG INTERVAL
 - 2.10.3.4 STANDARD FLOW LOG SETPOINT
 - 2.10.3.5 RAPID FLOW LOG INTERVAL
 - 2.10.3.6 RAPID FLOW LOG SETPOINT
- 2.11 OTHER CONTROL
 - 2.11.1 ELAPSED TIME RELAY
 - 2.11.1.1 ENABLE
 - 2.11.1.2 INTERVAL
 - 2.11.1.3 RELAY DURATION
 - 2.11.1.4 ASSIGNED RELAY
 - 2.11.1.5 RELAY LOGIC
 - 2.11.2 TIME OF DAY RELAY
 - 2.11.2.1 ENABLE
 - 2.11.2.2 ACTIVATION TIME
 - 2.11.2.3 RELAY DURATION
 - 2.11.2.4 ASSIGNED RELAY
 - 2.11.2.5 RELAY LOGIC

2. SETUP - OTHER CONTROL (cont'd)

- 2.11.3 EXTERNAL TOTALIZER (LUT430, 440 only)
 - 2.11.3.1 ENABLE
 - 2.11.3.2 MULTIPLIER
 - 2.11.3.3 RELAY DURATION
 - 2.11.3.4 ASSIGNED RELAY
 - 2.11.3.5 RELAY LOGIC
- 2.11.4 EXTERNAL SAMPLER (LUT430, 440 only)
 - 2.11.4.1 ENABLE
 - 2.11.4.2 MULTIPLIER
 - 2.11.4.3 INTERVAL
 - 2.11.4.4 RELAY DURATION
 - 2.11.4.5 ASSIGNED RELAY
 - 2.11.4.6 RELAY LOGIC
- 2.12 SIGNAL PROCESSING
 - 2.12.1 TEMPERATURE AND VELOCITY
 - 2.12.1.1 SOUND VELOCITY
 - 2.12.1.2 PROCESS TEMPERATURE
 - 2.12.1.3 TEMPERATURE SOURCE
 - 2.12.1.4 FIXED TEMPERATURE
 - 2.12.1.5 SOUND VELOCITY AT 20 DEGREES C
 - 2.12.1.6 AUTO SOUND VELOCITY
 - 2.12.2 ECHO SELECT
 - 2.12.2.1 ALGORITHM
 - 2.12.2.2 ECHO THRESHOLD
 - 2.12.2.3 REFORM ECHO
 - 2.12.2.4 NARROW ECHO FILTER
 - 2.12.2.5 SUBMERGENCE DETECTION
 - 2.12.3 TVT SETUP
 - 2.12.3.1 AUTO FALSE ECHO SUPPRESSION
 - 2.12.3.2 AUTO SUPP RANGE
 - 2.12.3.3 HOVER LEVEL
 - 2.12.3.4 SHAPER MODE
 - 2.12.4 TVT SHAPER
 - 2.12.4.1 BRKPT. 1-8
 - 2.12.4.2 BRKPT. 9-16
 - 2.12.4.3 BRKPT. 17-24
 - 2.12.4.4 BRKPT. 25-32
 - 2.12.4.5 BRKPT. 33-40
 - 2.12.5 MEAS. VALUES
 - 2.12.5.1 LEVEL MEAS.
 - 2.12.5.2 SPACE MEAS.
 - 2.12.5.3 DISTANCE MEAS.
 - 2.12.5.4 VOLUME MEAS.
 - 2.12.5.5 HEAD MEAS.
 - 2.12.5.6 FLOW MEAS. (LUT430, 440 only)
- 2.13 DISPLAY
 - 2.13.1 LOCAL DISPLAY BACKLIGHT
 - 2.13.2 LCD CONTRAST
- 2.14 DATE AND TIME
 - 2.14.1 DATE
 - 2.14.2 TIME

2. SETUP - DATE AND TIME (cont'd)

- 2.14.3 DAYLIGHT SAVING
 - 2.14.3.1 ENABLE
 - 2.14.3.2 STARTING ORDINAL
 - 2.14.3.3 STARTING DAY
 - 2.14.3.4 STARTING MONTH
 - 2.14.3.5 ENDING ORDINAL
 - 2.14.3.6 ENDING DAY
 - 2.14.3.7 ENDING MONTH
- 2.15 FLOW (LUT430, 440 only)
 - 2.15.1 PRIMARY MEASURING DEVICE
 - 2.15.2 AUTO ZERO HEAD
 - 2.15.3 BASIC SETUP
 - 2.15.3.1 METHOD OF FLOW CALCULATION
 - 2.15.3.2 FLOW EXPONENT
 - 2.15.3.3 MAXIMUM HEAD
 - 2.15.3.4 MAXIMUM FLOW AT 20MA
 - 2.15.3.5 ZERO HEAD OFFSET
 - 2.15.3.6 FLOWRATE DECIMAL
 - 2.15.3.7 FLOWRATE UNITS
 - 2.15.3.8 USER DEFINED UNIT
 - 2.15.3.9 LOW FLOW CUTOFF
 - 2.15.4 PMD DIMENSIONS
 - 2.15.4.1 K FACTOR
 - 2.15.4.2 V NOTCH ANGLE
 - 2.15.4.3 SLOPE
 - 2.15.4.4 ROUGHNESS COEFFICIENT
 - 2.15.4.5 OCM DIMENSION 1
 - 2.15.4.6 OCM DIMENSION 2
 - 2.15.4.7 OCM DIMENSION 3
 - 2.15.4.8 OCM DIMENSION 4
 - 2.15.5 UNIVERSAL HEAD VS FLOW
 - 2.15.5.1 TABLE 1-8
 - 2.15.5.2 TABLE 9-16
 - 2.15.5.3 TABLE 17-24
 - 2.15.5.4 TABLE 25-32
- 2.16 TOTALIZERS (LUT430, 440 only)
 - 2.16.1 DAILY TOTALIZER
 - 2.16.2 RUNNING TOTALIZER
 - 2.16.3 TOTALIZER DECIMAL POSITION
 - 2.16.4 TOTALIZER MULTIPLIER
 - 2.16.5 RESET DAILY TOTALIZER
 - 2.16.6 RESET RUNNING TOTALIZER

3. MAINTENANCE AND DIAGNOSTICS

- 3.1 IDENTIFICATION
 - 3.1.1 TAG
 - 3.1.2 LONG TAG
 - 3.1.3 DESCRIPTOR
 - 3.1.4 MESSAGE
 - 3.1.5 INSTALLATION DATE
 - 3.1.6 PRODUCT
 - 3.1.7 ORDER NO.
 - 3.1.8 SERIAL NUMBER
 - 3.1.9 FINAL ASSEMBLY NUMBER
 - 3.1.10 HARDWARE REV
 - 3.1.11 FIRMWARE REV
 - 3.1.12 LOADER REV
 - 3.1.13 MANUF. DATE
 - 3.1.14 ORDER OPTION
- 3.2 DIAGNOSTICS
 - 3.2.1 ECHO PROFILE
 - 3.2.2 TREND
 - 3.2.3 MASTER RESET
 - 3.2.4 POWER-ON RESETS
 - 3.2.5 POWER-ON TIME
 - 3.2.6 VIEW LOGS
 - 3.2.6.1 ALARMS
 - 3.2.6.2 OCM
 - 3.2.6.3 DAILY TOTALS
 - 3.2.6.4 PV
 - 3.2.7 PUMP RECORDS
 - 3.2.7.1 RUN TIME RELAY 2
 - 3.2.7.2 RUN TIME RELAY 3
 - 3.2.7.3 RELAY PUMP 1
 - 3.2.7.4 RELAY PUMP 2
 - 3.2.8 TEMPERATURE PEAK VALUES
 - 3.2.8.1 HIGHEST VALUE
 - 3.2.8.2 LOWEST VALUE
 - 3.2.9 ECHO QUALITY
 - 3.2.9.1 FIGURE OF MERIT
 - 3.2.9.2 CONFIDENCE
 - 3.2.9.3 ECHO STRENGTH
 - 3.2.9.4 NOISE AVERAGE
 - 3.2.9.5 NOISE PEAK
- 3.3 MAINTENANCE
 - 3.3.1 TRANSDUCER ENABLE
 - 3.3.2 BACKUP CONTROL
 - 3.3.3 REMAIN. DEV. LIFE
 - 3.3.3.1 LIFETIME EXPECTED
 - 3.3.3.2 TIME IN OPER.
 - 3.3.3.3 REMAIN. LIFETIME
 - 3.3.3.4 REMINDER ACTIV.
 - 3.3.3.5 REMIND. 1 (REQ.)
 - 3.3.3.6 REMIND. 2 (DEM.)
 - 3.3.3.7 MAINT STAT
 - 3.3.3.8 ACK STATUS
 - 3.3.3.9 ACK

3. MAINTENANCE (cont'd)

3.3.4 REMAIN SENS LIFE

- 3.3.4.1 LIFETIME EXPECTED
- 3.3.4.2 TIME IN OPER.
- 3.3.4.3 REMAIN. LIFETIME
- 3.3.4.4 REMINDER ACTIV.
- 3.3.4.5 REMIND. 1 (REQ.)
- 3.3.4.6 REMIND. 2 (DEM.)
- 3.3.4.7 MAINT STAT
- 3.3.4.8 ACK STATUS
- 3.3.4.9 ACK

3.3.5 SERVICE SCHED.

- 3.3.5.1 SERV. INTERVAL
- 3.3.5.2 TIME LAST SERV
- 3.3.5.3 TIME NEXT SERVICE
- 3.3.5.4 REMINDER ACTIV.
- 3.3.5.5 REMIND. 1 (REQ.)
- 3.3.5.6 REMIND. 2 (DEM.)
- 3.3.5.7 MAINT STAT
- 3.3.5.8 ACK STATUS
- 3.3.5.9 ACK

3.3.6 CALIB. SCHED.

- 3.3.6.1 CALIB. INTERVAL
- 3.3.6.2 TIME LAST CALIB
- 3.3.6.3 TIME NEXT CALIB
- 3.3.6.4 REMINDER ACTIV.
- 3.3.6.5 REMIND. 1 (REQ.)
- 3.3.6.6 REMIND. 2 (DEM.)
- 3.3.6.7 MAINT STAT
- 3.3.6.8 ACK STATUS
- 3.3.6.9 ACK

3.4 SIMULATION

3.4.1 LEVEL

- 3.4.1.1 LEVEL SIMULATION ENABLE
- 3.4.1.2 LEVEL VALUE
- 3.4.1.3 RAMP
- 3.4.1.4 RAMP RATE

3.4.2 DISCRETE INPUTS

- 3.4.2.1 DISCRETE INPUT 1
- 3.4.2.2 DISCRETE INPUT 2

3.4.3 PUMP ACTIVATIONS

4. COMMUNICATION

4.1 DEVICE ADDRESS

5. SECURITY

5.1 WRITE PROTECTION

6. LANGUAGE

Glossary

- accuracy:** degree of conformity of a measure to a standard or a true value.
- algorithm:** a prescribed set of well-defined rules or processes for the solution of a problem in a finite number of steps.
- ambient temperature:** the temperature of the surrounding air that comes in contact with the enclosure of the device.
- Auto False-Echo Suppression:** a technique used to adjust the level of a TVT curve to avoid the reading of false echoes. (See TVT.)
- Auto False-Echo Suppression Range:** defines the endpoint of the TVT distance. (See TVT.) This is used in conjunction with auto false echo suppression.
- blanking:** a blind zone extending away from the reference point plus any additional shield length. The device is programmed to ignore this zone.
- confidence:** describes the quality of an echo. Higher values represent higher quality. Confidence threshold defines the minimum value.
- damping:** term applied to the performance of a device to denote the manner in which the measurement settles to its steady indication after a change in the value of the level.
- dB (decibel):** a unit used to measure the amplitude of signals.
- derating:** to decrease a rating suitable for normal conditions according to guidelines specified for different conditions.
- echo:** a signal that has been reflected with sufficient magnitude and delay to be perceived in some manner as a signal distinct from that directly transmitted. Echoes are frequently measured in decibels relative to the directly transmitted signal.
- echo confidence:** the recognition of the validity of the echo. A measure of echo reliability.
- echo lock window:** a window centered on an echo in order to locate and display the echo's position and true reading. Echoes outside the window are not immediately processed.
- Echo marker:** a marker that points to the processed echo.
- Echo Processing:** the process by which the device determines echoes.
- Echo Strength:** describes the strength of the selected echo in dB referred to 1 μ V rms.
- Echo Profile:** a graphical display of a processed echo.
- false echo:** any echo which is not the echo from the desired target. Generally, false echoes are created by vessel obstructions.
- far range:** the distance below the zero percent or empty point in a vessel.
- figure of merit:** combines noise level, tracking quality, and signal strength to measure the quality of the reported echo value.

frequency: the number of periods occurring per unit time. Frequency may be stated in cycles per second.

Hertz (Hz): unit of frequency, one cycle per second. 1 Gigahertz (GHz) is equal to 10^9 Hz.

HART: Highway Addressable Remote Transducer. An open communication protocol used to address field devices.

multiple echoes: secondary echoes that appear as double, triple, or quadruple echoes in the distance from the target echo.

parameters: in programming, variables that are given constant values for specific purposes or processes.

range: distance between a transducer and a target.

shot: one transmit pulse or measurement.

speed of sound: the speed at which sound is propagated through some medium under specified conditions.

stillpipe: a pipe that is mounted inside a vessel parallel to the vessel wall, and is open to the vessel at the bottom.

stilling well: see **stillpipe**.

TVT (time varying threshold): a time-varying curve that determines the threshold level above which echoes are determined to be valid.

Index

A

Abbreviations and Identifications

list 271

accuracy 247

alarm 76

bounded 77

common parameters 76

level 76

rate 79

temperature 78, 79

algorithms 181, 257

adjusting 244

alternate duty assist 80, 152

alternate duty backup 81, 82, 85

alternate duty service 83, 84

application

test 123

B

backup level override 69

blanking (see Near Range) 259

C

cable

routing 10

cables

requirements 20

characterization chart 73

coaxial cable 22, 23

communications 124

conduits

requirements 20

Connect 225

D

Damping

explanation 260

date 188

device description

HART 125

dimensions 63

discrete input

pump interlock 87

discrete inputs 69

wiring 69

display 249

distance calculation 262

E

echo profile

algorithms 181

echo selection

Algorithm 257

edit mode

handheld programmer 37

key functions 37

exponential flow 100

external totalizers 93

F

fail-safe 63

Fail-safe Mode

explanation 261

Fail-safe Timer

explanation 261

fat ring 90

Figure of Merit (FOM) 202, 256, 258

fixed duty assist 82

flow calculation 265

flume

cut throat 103, 104

H flume 115

Leopold Lagco 102

Palmer Bowlus 114

Parshall 101, 117

rectangular 105

universal trapezoidal 117

FOM 202, 256, 258

function keys

measurement mode 35

navigation mode 36

H

handheld programmer

edit mode 37

measurement mode 35

navigation 36

HART

device description 125

multi-drop mode 125

hazardous area installations

wiring requirements 31

I

Identifications and Abbreviations

list 271

in bounds 77

inputs 249

installation

hazardous area requirements 31

interlock
pump 87

K

key functions
edit mode 37

L

LCD display
fast mode 201
measurement mode 34, 38
PROGRAM mode 35

level alarms 76

LOE

Fail-safe Mode 261

loss of echo (LOE) 63

LUI 7, 33

backup 225
commissioning 33
parameter reference 137
Quick Start wizards 38

M

measurement
difficulties 242
set up 63
setting up 63
single point 63
starting 63

mounting

wall mount 12

multi-drop mode 125

N

Near Range
explanation 259

noise problems 240

noise sources 241

O

OCM (open channel monitoring) 97
common parameters 98
cut throat 103, 104
flow characterization chart 116
flow exponent support 100
H flume 115
Leopold Lagco flume 102
Palmer Bowlus flume 114
Parshall flume 101
rectangular flume 105
universal calculation 116
universal Parshall flume 117
universal trapezoidal flume 117
V-Notch weir 106, 107, 109, 110, 111,
112

weirs 100
zero head 99

operation

single point 63

out of bounds 77

outputs 248

P

parameter
relays 67
parameters
record temperatures 202

power 21

programmer
handheld 35

programming 249

alarms 76
relays 64

pump

alternate duty backup 81, 85
discrete input 87
fault 87
interlock 87
off setpoint 81, 82, 83, 84, 86
on setpoints 81, 82, 83, 84, 86
other controls 82
pump down 80
pump up 85
reservoir 85
run-on 88
start delay 89
totalizing volume 88
wet well 80

pump control

algorithms 79, 80, 93
options 80

pump interlock 87

pump strategies 79

Q

quick start 63

R

randomize setpoints 90
range 247

relay

modifiers 67
parameters 67
programming 64
totalizer 94

resolution 247

Response Rate
explanation 260

- response rate 63
- run-on 88
- S**
- samplers 93
- SCADA 124
- scum ring See wall cling 90
- service ratio
 - overview 80
- settings
 - adjust parameters via LUI 37
- simulation 120
 - Discrete Input 120, 123
 - Level 120
 - level cycle 123
 - process 122
 - single measurement 122
- single point 63
- sound velocity 262
- start delay 89
- starting measurement 63
- synchronization 27

T

- tank shape 73
- technical support
 - contact information 1, 4, 58, 269
- temperature
 - alarm 78, 79
 - compensation 247
 - error 248
- testing
 - application 123
- time control 92
- Time To Spill 170
- totalizer 94
- transducers 23, 249
 - connection 23
 - enable/disable 38, 203
- transmit pulse 255
- trends
 - viewing via LUI 118
- troubleshooting
 - noise problems 240
- TS-3 23

U

- universal
 - example 74
 - volume 73

V

- vessel shape
 - selection 147

- volume
 - calculation 263
 - characterization chart 73
 - dimensions 63
 - readings 73
 - tank shape 73
 - universal example 74

W

- wall cling 90
- weight 250
- weir
 - standard 100
 - V-Notch 106, 107, 109, 110, 111, 112
- wet well 80
- wiring
 - cables 20
 - hazardous areas 31
 - problems 241
 - wrong reading 244

Notes

For more information

www.siemens.com/level

www.siemens.com/continuous-weighing

Siemens AG
Industry Sector
1954 Technology Drive
P.O. Box 4225
Peterborough, ON
Canada K9J 7B1

email: techpubs.smpi@siemens.com

www.siemens.com/processautomation

Subject to change without prior notice
7ML19985MV01 Rev. 1.1

© Siemens AG 2012



7 M L 1 9 9 8 5 M V 0 1
Printed in Canada