

Radar Transmitters

SITRANS Probe LR

Operating Instructions · 01/2011



SITRANS

SIEMENS

Safety Guidelines: Warning notices must be observed to ensure personal safety as well as that of others, and to protect the product and the connected equipment. These warning notices are accompanied by a clarification of the level of caution to be observed.

Qualified Personnel: This device/system may only be set up and operated in conjunction with this manual. Qualified personnel are only authorized to install and operate this equipment in accordance with established safety practices and standards.

Unit Repair and Excluded Liability:

- The user is responsible for all changes and repairs made to the device by the user or the user's agent.
- All new components are to be provided by Siemens Milltronics Process Instruments.
- Restrict repair to faulty components only.
- Do not reuse faulty components.

Warning: Cardboard shipping package provides limited humidity and moisture protection. This product can only function properly and safely if it is correctly transported, stored, installed, set up, operated, and maintained.

This product is intended for use in industrial areas. Operation of this equipment in a residential area may cause interference to several frequency based communications.

Note: Always use product in accordance with specifications.

Copyright Siemens AG 2011. All Rights Reserved

Disclaimer of Liability

This document is available in bound version and in electronic version. We encourage users to purchase authorized bound manuals, or to view electronic versions as designed and authored by Siemens Milltronics Process Instruments. Siemens Milltronics Process Instruments will not be responsible for the contents of partial or whole reproductions of either bound or electronic versions.

While we have verified the contents of this manual for agreement with the instrumentation described, variations remain possible. Thus we cannot guarantee full agreement. The contents of this manual are regularly reviewed and corrections are included in subsequent editions. We welcome all suggestions for improvement.

Technical data subject to change.

MILLTRONICS® is a registered trademark of Siemens Milltronics Process Instruments.

Contact SMPI Technical Publications

at the following address:

Technical Publications
Siemens AG
Siemens Milltronics Process Instruments
1954 Technology Drive, P.O. Box 4225
Peterborough, Ontario, Canada, K9J 7B1
Email: techpubs.smpi@siemens.com

European Authorized Representative

Siemens AG
Industry Sector
76181 Karlsruhe
Deutschland

- For a selection of Siemens Milltronics level measurement manuals, go to: **www.siemens.com/processautomation**. Under Process Instrumentation, select *Level Measurement* and then go to the manual archive listed under the product family.
- For a selection of Siemens Milltronics weighing manuals, go to: **www.siemens.com/processautomation**. Under Weighing Technology, select *Continuous Weighing Systems* and then go to the manual archive listed under the product family.

Table of Contents

Safety Notes	
Safety marking symbols	1
The Manual	1
Application Examples	2
Support	2
Abbreviations and Identifications	2
SITRANS Probe LR	4
Applications	4
SITRANS Probe LR System Implementation	5
Programming	5
SITRANS Probe LR Approvals and Certificates	5
Specifications	7
SITRANS Probe LR	7
Power	7
Performance	7
Interface	8
Programmer (infrared keypad)	8
Mechanical	9
Environmental	9
Process	10
Approvals (verify against device nameplate)	10
Installation	
Mounting location	12
Location on a nozzle, or on a manhole cover	14
Mounting Instructions	14
SITRANS Probe LR: Dimensions	15
Wiring	16
Power	16
Connecting SITRANS Probe LR	16
Operating SITRANS Probe LR	18
RUN Mode	18
Display	18
PROGRAM Mode	19
Programming	19
Display	19
Low temperature effects on RUN/PROGRAM modes	20
Security	21
Handheld programmer	21
Activating SITRANS Probe LR	22
Accessing a parameter	22
Changing a Parameter Value	23
Using Units or Percent (%)	24

Quick Setup for local operation (outline)	24
Setup Instructions	24
Additional Settings	29
Application Examples	30
Example 1: Liquid resin in storage vessel, level measurement	30
Example 2: Horizontal vessel with volume measurement	32
Parameter Reference	35
Helpful Hints	35
To access a parameter and change a value (primary index):	35
To access a secondary index and change a value:	36
Quick Start (P001 to P010).....	38
Volume (P050 to P055).....	42
Lock (P069).....	47
Failsafe (P070 to P073).....	47
mA Output (P201 to P215).....	48
Installation Records (P341 to P346)	52
Range Calibration (P652 to P655)	53
Rate (P700 and P701).....	55
Measurement Verification (P709 to P713)	56
Communications (P799).....	59
Echo Processing (P800 to P807)	59
Algorithm (P820).....	62
TVT (Time Varying Threshold) Adjustment Parameters (P831 to P839)	63
Test (P900 to P924)	66
Measurement	67

Appendix A: Alphabetical Parameter List	69
Appendix B: Programming Chart	72
Appendix C: HART	75
HART Communications for SITRANS Probe LR	75
HART Electronic Device Description (EDD)	75
HART Communicator 275/375:	76
SIMATIC Process Device Manager (PDM)	79
Maintenance settings (accessible via PDM only)	79
HART Version	80
Burst mode	80
Appendix D: Troubleshooting	81
Communication Troubleshooting	81
Generally:	81
Specifically:	81
General Fault Codes	82
Fault Codes (Firmware Revision 3.02 or higher)	82
Fault Codes (Firmware Revision 1.05 or earlier)	85
Operation Troubleshooting	88
Maintenance	91
Unit Repair and Excluded Liability	91
Appendix E: Technical Reference	92
Principles of Operation	92
Transceiver	92
Typical Receiver Signal	93
Near Blanking	93
Loss of Echo (LOE)	93
Range Extension	94
False-Echo Suppression	94
TVT (Time Varying Threshold) curves	94
Auto False-Echo Suppression	94
RUN/PROGRAM	96
Output	96
Failsafe	97
Chemical compatibility	97
Appendix F: Special Applications	98
Application Example: Stilling-well	98
Appendix G: hazardous area installations	100
Wiring Details	100
Intrinsically Safe Model	100
FM/CSA	101
EU Equivalency	101
Loop Voltage versus Loop Resistance	102
IS Safety Barrier Selection	102
How to select a passive barrier for SITRANS Probe LR	102
PLC Input Modules.....	103
Passive Shunt Diode Barriers	103
Active barriers (repeating barriers).....	103

Instructions specific to hazardous area installations	104
(Reference European ATEX Directive 94/9/EC,	104
Annex II, 1/0/6)	104
Product Nameplate	105
Intrinsically safe connection drawing (FM)	106
Intrinsically safe connection drawing (CSA)	107
Non-incendive connection drawing (FM)	108
Appendix H: Firmware Revision History	109
Glossary	111
Index	115

Safety Notes

Special attention must be paid to warnings and notes highlighted from the rest of the text by grey boxes.



WARNING: relates to a caution symbol on the product, and means that failure to observe the necessary precautions can result in death, serious injury, and/or considerable material damage.



WARNING¹: means that failure to observe the necessary precautions can result in death, serious injury, and/or considerable material damage.

Note: means important information about the product or that part of the operating manual.

Safety marking symbols

In manual:	On product:	Description
		Earth (ground) Terminal
		(Label on product: yellow background.) WARNING: refer to accompanying documents (manual) for details.

The Manual

Notes:

- Please follow the installation and operating procedures for a quick, trouble-free installation and to ensure the maximum accuracy and reliability of your SITRANS Probe LR.
- This manual applies to the SITRANS Probe LR only.
- This product is intended for use in industrial areas. Operation of this equipment in a residential area may cause interference to several frequency based communications.

This manual will help you set up your SITRANS Probe LR for optimum performance. We always welcome suggestions and comments about manual content, design, and accessibility.

Please direct your comments to techpubs.smpi@siemens.com. For other Siemens level measurement manuals, go to www.siemens.com/level, and look under Level Measurement.

¹ This symbol is used when there is no corresponding symbol on the product.

! WARNING: Changes or modifications not expressly approved by Siemens could void the user's authority to operate the equipment.

Note: This equipment has been tested and found to comply with the limits for a Class A digital device, pursuant to Part 15 of the FCC Rules. These limits are designed to provide reasonable protection against harmful interference when the equipment is operated in a commercial environment. This equipment generates, uses, and can radiate radio frequency energy and, if not installed and used in accordance with the instruction manual, may cause harmful interference to radio communications. Operation of this equipment in a residential area is likely to cause harmful interference, in which case the user will be required to correct the interference at his own expense.

Application Examples

The application examples used in this manual illustrate typical installations using SITRANS Probe LR. Because there is often a range of ways to approach an application, other configurations may also apply.

In all examples, substitute your own application details. If the examples do not apply to your application, check the applicable parameter reference for the available options.

Standard applications are found in the main body of the manual: for more specialized applications, please see *Appendix F: Special Applications*, page 98.

Support

If you have questions you can access our 24-hour hotline at:
www.siemens.com/automation/support-request.

Phone: +49 180 50 50 222

Abbreviations and Identifications

Short form	Long Form	Description	Units
A/D	Analog to digital		
CE / FM / CSA	Conformitè Européene / Factory Mutual / Canadian Standards Association	safety approval	
C _i	Internal capacitance		
D/A	Digital to analog		
DAC	Digital Analog Converter		
DCS	Distributed Control System	control room apparatus	

Short form	Long Form	Description	Units
FV	Full Vacuum		
ESD	Electrostatic Discharge		
HART	Highway Addressable Remote Transducer		
I_i	Input current		mA
I_o	Output current		mA
IS	Intrinsically Safe	safety approval	
L_i	Internal inductance		mH
LRV	Lower Range Value	value for process empty level	4 mA ^a
LSL	Lower Sensor Limit	below which no PV is anticipated	
mH	MilliHenry	10^{-3}	Henry
μ F	MicroFarad	10^{-6}	Farad
μ s	Microsecond	10^{-6}	Second
PBT	Polybutylene terephthalate		
PED	Pressure Equipment Directive	safety approval	
PEI	Polyether Imide		
pF	Pico Farads	10^{-12}	Farad
ppm	Parts per Million		
PV	Primary Variable	measured value	
SELV	Safety Extra Low Voltage		
SV	Secondary Variable	equivalent value	
TV	Transmitter Variable		
TVT	Time Varying Threshold	sensitivity threshold	
U_i	Input voltage		V
U_o	Output voltage		V
URV	Upper Range Value	value for process full level	20 mA ^a
USL	Upper Sensor Limit	above which no PV is anticipated	

- a. 100% is most commonly set to 20 mA, and 0% to 4 mA: however, the settings can be reversed.

SITRANS Probe LR

SITRANS Probe LR is a 2-wire loop-powered, continuous level measuring instrument that utilizes advanced pulse radar technology at 5.8 GHz (6.3 GHz in North America). The instrument consists of an electronic component coupled to the antenna and process connection. It is very easy to install and set up, using either the infrared handheld programmer locally, or using SIMATIC¹ PDM from a remote location.

Communication is via HART². Signals are processed using Sonic Intelligence[®] which has been field-proven in over 500,000 applications worldwide (ultrasonic and radar).

SITRANS Probe LR is available in two versions

- General Purpose (non-hazardous)
- Intrinsically Safe (with suitable barrier)

Applications

Notes:

- Please refer to product label for approval information.
- SITRANS Probe LR is to be used only in the manner outlined in this manual, otherwise protection provided by the equipment may be impaired.

SITRANS Probe LR is designed to measure liquid levels in a variety of applications:

- liquid bulk storage vessels
- simple process vessels with gentle agitation
- liquids
- slurries

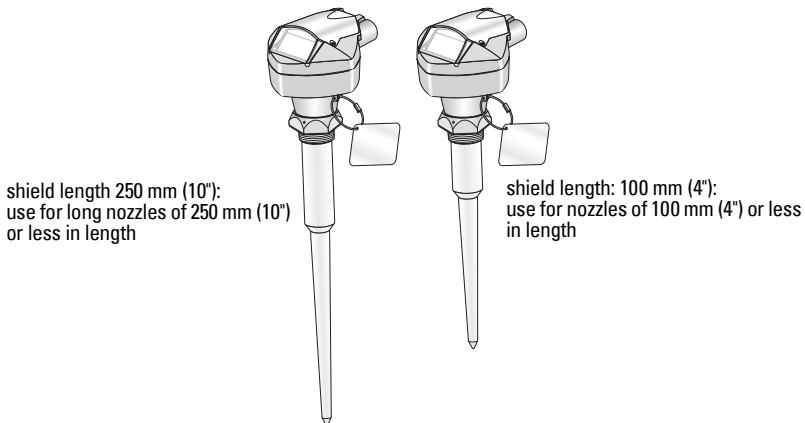

1. SIMATIC[®] is a registered trademark of Siemens AG.
2. HART[®] is a registered trademark of the HART Communication Foundation.

SITRANS Probe LR System Implementation

SITRANS Probe LR supports HART communication protocol and SIMATIC PDM software.

Typical PLC/mA configuration with HART

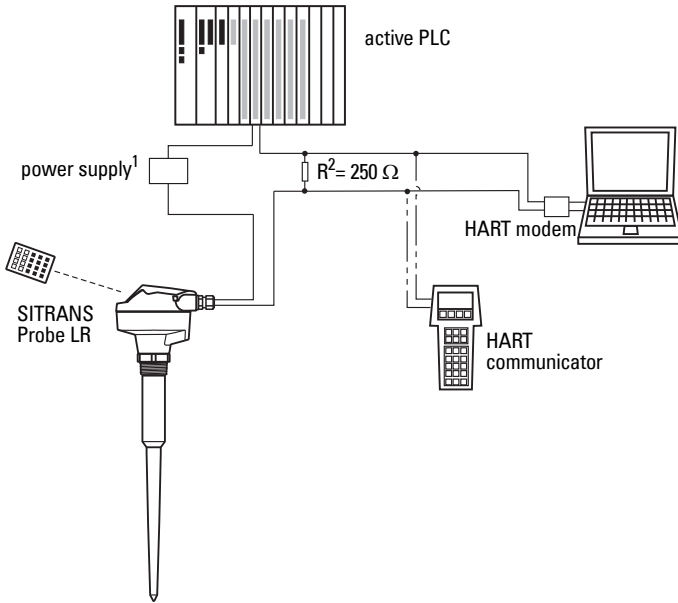

Programming

SITRANS Probe LR carries out its level measurement function according to the set of built-in parameters. You can make parameter changes via the handheld programmer, via a PC using SIMATIC PDM, or via a HART Handheld Communicator.

SITRANS Probe LR Approvals and Certificates

Note: Please see *Approvals (verify against device nameplate)* on page 10 for an approvals listing.

1. Depending on the system design, the power supply may be separate from the PLC, or integral to it.
2. A 250 Ohm resistor may be required if the loop resistance is less than 250 Ohms.

Notes

Specifications

Notes:

- Siemens makes every attempt to ensure the accuracy of these specifications but reserves the right to change them at any time.
- Please check the ambient and operating temperatures under *Enclosure* on page 9, and *Approvals (verify against device nameplate)* on page 10; also check *Approvals (verify against device nameplate)* on page 10, for the specific configuration you are about to use or install.

SITRANS Probe LR

Power



Nominal 24 V DC at
max. 550 Ohm.

For other configurations, see the chart *Loop Voltage versus Loop Resistance* on page 102.

- Maximum 30 V DC
- 4 to 20 mA

Performance

Reference operating conditions according to IEC 60770-1

- ambient temperature +15 to +25 °C (+59 to +77 °F)
- humidity 45% to 75% relative humidity
- ambient pressure 860 to 1060 mbar g (86000 to 106000 N/m² g)

Measurement Accuracy (measured in accordance with IEC 60770-1)

- non-linearity (accuracy) the greater of: 10 mm (0.4"), or 0.10% of Span (including hysteresis and non-repeatability)
- non-repeatability 5 mm (included in non-linearity specification)
- deadband (resolution) 5 mm (included in non-linearity specification)

Analog Output Accuracy (measured in accordance with IEC 60770-1)

- non-linearity (accuracy) 0.125% of Span (including hysteresis and non-repeatability)
- non-repeatability 0.025% of Span (included in non-linearity specification)
- deadband (resolution) 0.0375% of Span (included in non-linearity specification)

Frequency	5.8 GHz (6.3 GHz in N. America): refer to product nameplate for confirmation
Max. measurement range ¹⁾	20 m (65 ft)
Update time	mA output and loop display is updated once per second
Minimum detectable distance ¹⁾²⁾	0.3 m (1 ft), plus the shield length (if any)
Influence of ambient temperature	0.003% / K
Dielectric constant	$\epsilon_r > 3$ (for < 3 use waveguide antenna or stillpipe)

Memory:

- non-volatile EEPROM
- no battery required.

Interface

- HART
- configuration: Siemens SIMATIC PDM (PC), or HART handheld communicator, or Siemens infrared handheld programmer
- analog output: 4 to 20 mA, ± 0.02 mA accuracy
- display (local): multi-segment alphanumeric liquid crystal with bar graph (representing level)

Programmer (infrared keypad)

Siemens Milltronics Infrared IS (Intrinsically Safe) Handheld Programmer for hazardous and all other locations (battery is non-replaceable)

- approval: ATEX II 1 G, EEx ia IIC T4, certificate SIRA 01ATEX2147 FM/CSA Class 1, Div. 1, Groups A, B, C, D
- ambient temperature: -20 to $+40$ °C (-5 to $+104$ °F)
- interface: proprietary infrared pulse signal
- power: 3 V lithium battery
- weight: 150 g (0.3 lb)
- color: black

1. Referenced from the sensor reference point.

2. See 'Near Blanking' on page 93 for more details.

Mechanical

Process Connections:

- threaded connection 1.5" NPT, BSP, or G (BS EN ISO 228-1)

Antenna:

- polypropylene rod hermetically sealed construction
standard 100 mm (4") shield for maximum 100 mm (4") nozzle,
or optional 250 mm (10") long shield

Notes:

- Please check the ambient and operating temperatures under *Enclosure* on this page, and *Approvals (verify against device nameplate)* on page 10; also check *Approvals (verify against device nameplate)* on page 10, for the specific configuration you are about to use or install.
- The use of approved watertight conduit hubs/glands is required for Type 4X / NEMA 4X, Type 6 / NEMA 6, IP67, IP68 (outdoor applications).

Enclosure

- body construction PBT (polybutylene terephthalate)
- lid construction hard-coated PEI (polyether imide)
- conduit entry 2 x M20x1.5 (plastic strain relief) or 2 x 1/2" NPT thread
- ingress protection Type 4X / NEMA 4X, Type 6 / NEMA 6, IP67, IP68 (see note below)

Weight:

- standard model¹ 1.97 kg (4.35 lb.)

Environmental

- location: indoor/ outdoor
- altitude: 5000 m (16,404 ft) max.
- ambient temperature: -40 to +80 °C (-40 to +176 °F)
- relative humidity: suitable for outdoor
Type 4X / NEMA 4X, Type 6 / NEMA 6, IP67, IP68 enclosure
(see note below)
- installation category: I
- pollution degree: 4

¹. Unit with 100 mm (4") rod and adaptors

Process

- temperature: –40 to +80 °C (–40 to +176 °F).
(at process connection)
- pressure (vessel): maximum 3 bar, gauge (43.5 psi, gauge)

Notes:

- Please check the ambient and operating temperatures under *Enclosure* on this page, and *Approvals (verify against device nameplate)* on page 10; also check *Approvals (verify against device nameplate)* on page 10, for the specific configuration you are about to use or install.
- The use of approved watertight conduit hubs/glands is required for Type 4X / NEMA 4X, Type 6 / NEMA 6, IP67, IP68 (outdoor applications).

Approvals (verify against device nameplate)

- General CSA_{US/C}, FM, CE, C-TICK
- Radio Europe (R&TTE), FCC, Industry Canada
- Hazardous Intrinsically Safe: (Europe) ATEX II 1 G, EEx ia IIC T4
(US/Canada) FM/CSA: (barrier required)¹
Class I, Div. 1, Groups A, B, C, D
Class II, Div. 1, Groups E, F, G
Class III T4
(Australia) ANZEx Ex ia IIC T4
(Tamb = –40 to +80 °C) IP67, IP68
(International) IECEx TSA 04.0020X Ex ia IIC T4
(Brazil) INMETRO: BR-Ex ia IIC T4
Non-incendive: (US) FM²:
Class I, Div. 2, Groups A, B, C, D T5
- Marine Lloyd's Register of Shipping
ABS Type Approval

Note: EN 61000-4-3 (CE EMC) testing was conducted on the SITRANS Probe LR while mounted in a metallic vessel.

¹ See 'Intrinsically safe connection drawing (FM)' on page 106 for drawing number 23651611, or 'Intrinsically safe connection drawing (CSA)' on page 107 for drawing number 23651621.
² See 'Non-incendive connection drawing (FM)' on page 108 for drawing number 23650537.

Installation



• WARNINGS:

- **Installation shall only be performed by qualified personnel and in accordance with local governing regulations.**
- **SITRANS Probe LR 'is to be used only in the manner outlined in this manual, otherwise protection provided by the device may be impaired.**
- **Never attempt to loosen, remove, or disassemble process connection or instrument housing while vessel contents are under pressure.**
- **This product is designated as a Pressure Accessory per Directive 97/ 23 / EC and is not intended for use as a safety device.**
- **Materials of construction are chosen based on their chemical compatibility (or inertness) for general purposes. For exposure to specific environments, check with chemical compatibility charts before installing.**
- **The user is responsible for the selection of bolting and gasket materials which will fall within the limits of the flange and its intended use and which are suitable for the service conditions.**
- **Improper installation may result in loss of process pressure.**

Notes:

- Refer to the device nameplate for approval information.
- The Process Device Tag shall remain with the process pressure boundary assembly¹. In the event the instrument package is replaced, the Process Device Tag shall be transferred to the replacement unit.
- SITRANS Probe LR units are hydrostatically tested, meeting or exceeding the requirements of the ASME Boiler and Pressure Vessel Code and the European Pressure Equipment Directive.
- The serial numbers stamped in each process connection body provide a unique identification number indicating date of manufacture.
Example: MMDDYY – XXX (where MM = month, DD = day, YY = year, and XXX= sequential unit produced
Further markings (space permitting) indicate flange configuration, size, pressure class, material, and material heat code.

¹. The process pressure boundary assembly comprises the components that act as a barrier against pressure loss from the process vessel: that is, the combination of process connection body and emitter, but normally excluding the electrical enclosure.

Mounting location

Recommendations:

- Ensure ambient temperature is within -40 to 80 °C (-40 to 176 °F).
- Provide easy access for viewing the display and programming via the handheld programmer.
- Ensure the environment is suitable to the housing rating and materials of construction.

Precautions:

- Avoid proximity to high voltage or current wiring, high voltage or current contacts, and to variable frequency motor speed controllers.
- Avoid interference to the emission cone from obstructions or from the fill path.
- Avoid central locations on vessels.

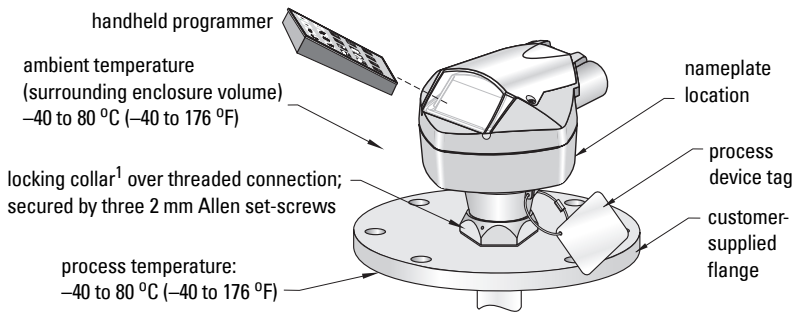

! **WARNING:** For vessels with conical or parabolic tops, avoid mounting the instrument at the centre. (The concavity of the top can focus echoes into the centre, giving false readings.)

Note: Under certain circumstances, it may be acceptable to mount Sitrans Probe LR at the centre of a flat-topped tank: please discuss this with your Siemens Milltronics representative.

✓✓ preferred
⊘ undesirable

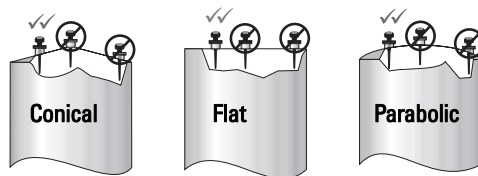

¹ When the locking collar is secured, it prevents the enclosure rotating on the threaded connection.

Keep the emission cone free of interference:

- Make allowance for the emission cone spreading: allow a minimum of 300 mm (1 ft) for every 3 m (10 ft) of vessel height.
- Locate the antenna away from the side wall, to avoid interference from indirect echoes.
- Avoid interference from objects such as ladders or pipes, which can cause false echoes.
- Make sure the beam angle does not intersect the fill path.

Notes:

- Beam angle is defined at the -3dB boundary, or 1/2 signal level. Obstructions outside of the beam may still be detected, depending on the size, shape, or distance from the antenna.
- For more detail on false echoes, see *False-Echo Suppression* on page 94.

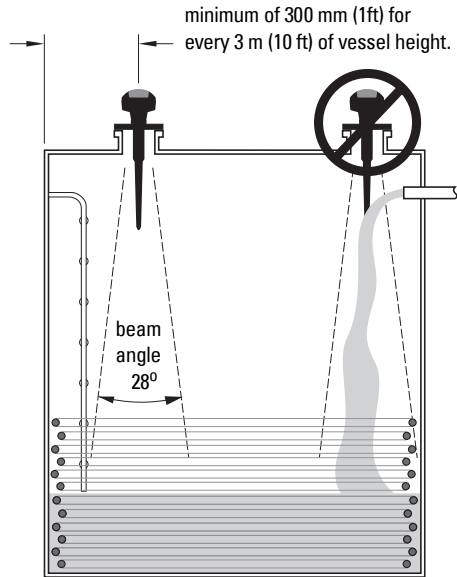

Location on a nozzle, or on a manhole cover

Notes:

- Use the 100 mm (4") shield on nozzles that are 100 mm (4") in length, or shorter.
- Use the 250 mm (10") shield on nozzles that are 250 mm (10") in length, or shorter.
- If your nozzle is longer than 250 mm (10"), contact your local representative. You will need to exchange the device for a different model with a longer shield length.

On a nozzle, the end of the shield section should protrude a minimum of 10 mm (0.4") to avoid interference.

A manhole cover is typically a covered nozzle with a diameter of 610 mm (24") or greater. To provide optimum signal conditions on a manhole cover, locate the antenna off-center, typically 100 mm (4") from the side.

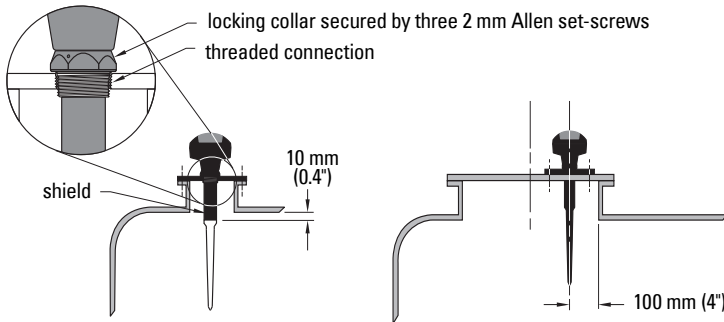

Note: For details on other applications, see *Appendix F: Special Applications* on page 98.

Mounting Instructions

Note: Do not rotate the enclosure after programming and vessel calibration, otherwise an error may occur, caused by a polarity shift of the transmit pulse.

1. Before inserting SITRANS Probe LR into its mounting connection, check to ensure the threads are matching, to avoid damaging them.
2. Simply screw SITRANS Probe LR into the process connection, and hand tighten. For pressure applications, it will be necessary to use PTFE tape (or other appropriate thread sealing compound) and tighten the process connection beyond hand tight. The maximum torque is 40 N-m (30 ft.lbs.).
3. If you want to rotate the enclosure, use a 2 mm Allen key to loosen the three set-screws that secure the locking collar.
4. Once the enclosure is in a suitable position, tighten the set-screws.

SITRANS Probe LR: Dimensions

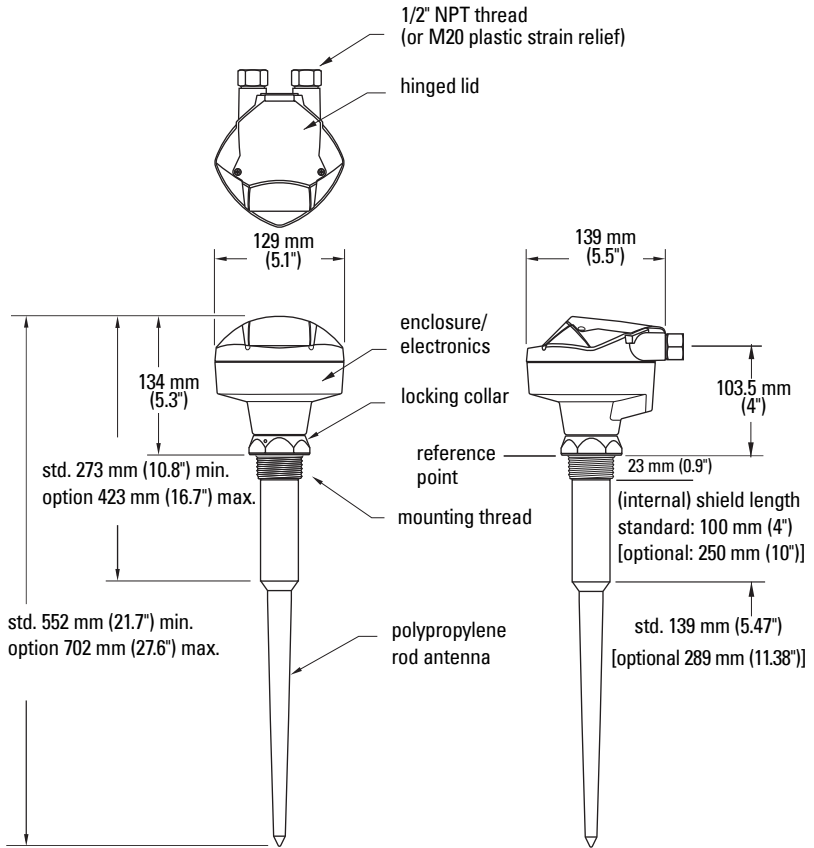

Installation

Wiring

Power

WARNINGS:



dc terminals shall be supplied from an SELV¹ source in accordance with IEC-1010-1 Annex H.



All field wiring must have insulation suitable for rated voltages.

Connecting SITRANS Probe LR

Unscrew the two lid screws to access the terminal block.

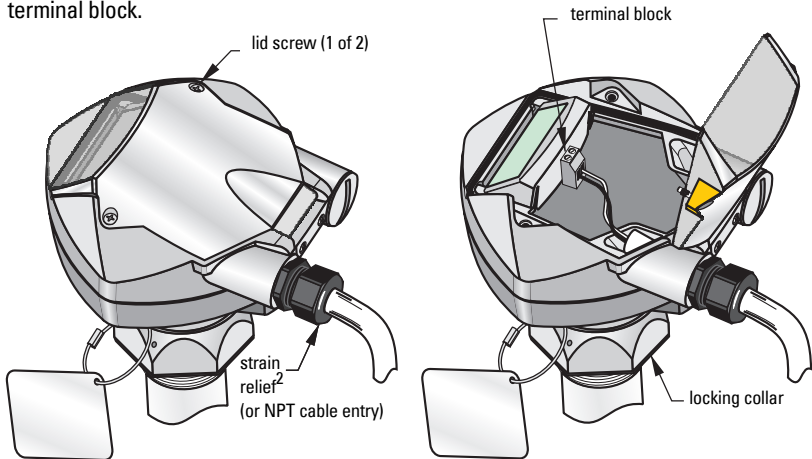

1. Safety Extra Low Voltage
2. If cable is routed through conduit, use only approved suitable-size hubs for waterproof applications.

Notes:

- Use shielded, twisted pair cable (wire gauge AWG 14 to 22).
 - Separate cables and conduits may be required to conform to standard instrumentation wiring practices or electrical codes.
 - The non-metallic enclosure does not provide a continuous ground path between conduit connections: use grounding type bushings and jumpers.
 - For detailed information on Intrinsic Safety setups, see *Wiring Details* on page 100.
1. If you want to rotate the enclosure, use a 2 mm Allen key to loosen the 3 Allen set-screws securing the locking collar. Position the unit and retighten the screws.
 2. Strip the cable jacket for approximately 70 mm from the end of the cable, and thread the wires through the strain relief¹.
 3. Connect the wires to the terminals: the polarity is identified on the terminal block.
 4. Tighten the strain relief to form a good seal.
 5. Close the lid and tighten screws: **please do not overtighten screws.** (Recommended torque is 1.1 to 1.7 N-m (10 to 15 in-lb) of torque.)

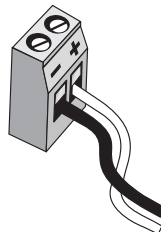

¹ If cable is routed through conduit, use only approved suitable-size hubs for waterproof applications.

Operating SITRANS Probe LR

SITRANS Probe LR has two modes of operation: **RUN** and **PROGRAM**.

RUN Mode

SITRANS Probe LR automatically starts in **RUN** mode when power is applied, and detects the material level. The primary reading displays the material level (in meters) referenced from Empty (process empty level). This is the default start-up display mode.

System status is displayed on the LCD, or on a remote communications terminal.

Display

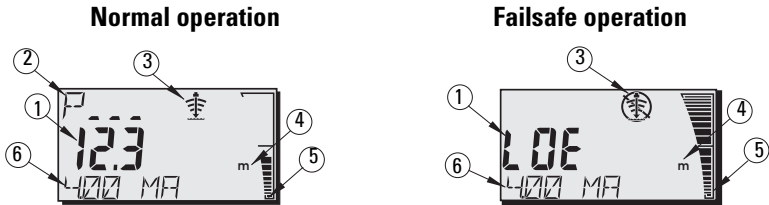

1 – Primary Reading (displays level, distance, or volume, in either units or percent)

2 – Secondary Reading (displays Parameter number for Auxiliary Reading¹)

3 – Echo status indicator: Reliable Echo  or Unreliable Echo 

4 – Units or Percent

5 – Active bar graph represents material level







6 – Auxiliary Reading (depending on the parameter selected, it displays milliAmp value, distance or confidence, with units where applicable)

If the echo confidence drops below the echo confidence threshold, the failsafe timer starts running. When the timer expires, the letters **LOE** (Loss of Echo) alternate with the reading every two seconds, and the Reliable Echo indicator is replaced by the Unreliable Echo indicator. When a valid reading is received, the level reading display returns to normal operation.

¹ Press  to display the auxiliary reading field when in **RUN** mode.

Handheld Programmer: function keys in RUN mode

Certain functions can be accessed directly from **RUN** mode by using specific keys.

Key	Run Mode
	mA output value displayed in auxiliary reading field.
	Internal enclosure temperature displayed in auxiliary reading field.
	Parameter for auxiliary readings ^a .
	Displays the value representing Echo Confidence (P805).
	Toggle between Units and % on reading display.
	Initiate and complete PROGRAM mode access.
	Distance displayed in auxiliary reading field.

a. Press  plus three-digit parameter number to set parameter to show in the auxiliary display.

PROGRAM Mode

Programming

- Set parameters to suit your specific application.
- Activate **PROGRAM** mode at any time, to change parameter values and set operating conditions.
- For local programming, use the Siemens handheld programmer.
- For programming from a distance, use either a PC running SIMATIC PDM, or a HART handheld communicator.





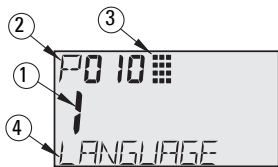





Note: Do not use the handheld programmer at the same time as SIMATIC PDM, or erratic operation may result.

Display



- 1 – Primary Reading (displays parameter value)
- 2 – Secondary Reading (displays parameter number)
- 3 – Programming indicator
- 4 – Auxiliary Reading (displays parameter names for the Quick Start parameters, if a language is selected. It displays the index value for indexed parameters, such as P054.)

Handheld Programmer: function keys in PROGRAM mode

Key	Programming Mode
	Values
	Decimal point
	Negative value
	CLEAR value
	TOGGLE between Units and % on parameter value
	End PROGRAM session and enable RUN mode
	Update echo quality parameters
	Parameter scroll-up
	Parameter scroll-down
	DISPLAY opens parameter fields
	ENTER the displayed value

Low temperature effects on RUN/PROGRAM modes

If the internal temperature falls to -30°C (-22°F) or below, it will affect both RUN and PROGRAM modes.

RUN mode will operate normally, with the following exceptions:

- handheld programmer operation is disabled
- the LCD displays only limited information: the bar graph and the reliable/unreliable echo indicator

PROGRAM mode:

- handheld programmer operation is disabled

Security

The Lock parameter, P000, secures SITRANS Probe LR against changes via the handheld programmer. To enable programming, set P000 to the Unlocked Value stored in P069. To disable programming, enter a different value.

Note:

- A remote master can still change configuration, if P799 is set to allow this.

Handheld programmer

Note: For detailed instructions on using the handheld programmer, see the next page.

For direct access to SITRANS Probe LR, point the handheld programmer at the display from a maximum distance of 600 mm (2 ft), and press the keys.

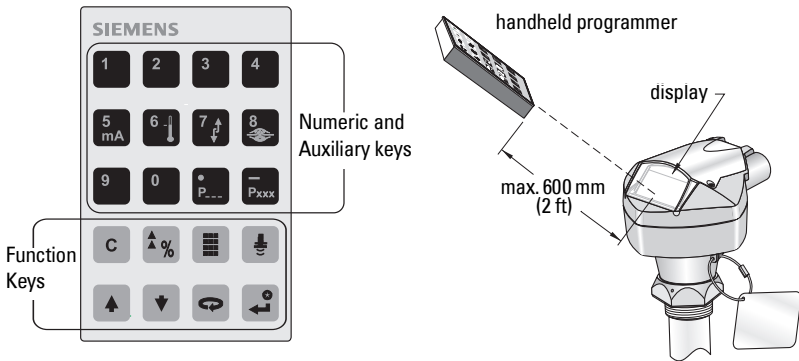

Activating SITRANS Probe LR

Note: Keep infrared devices such as laptops, cell phones, and PDAs, away from SITRANS Probe LR to prevent inadvertent operation.

Power up the instrument. SITRANS Probe LR starts in **RUN** mode, and detects the material level. It displays the material level (in meters) referenced from Empty (process empty level). This is the default start-up mode.



Accessing a parameter

Notes:

- The following instructions apply when using the Handheld Programmer.
- Do not use the Handheld Programmer at the same time as SIMATIC PDM, or erratic operation may result.
- You do not need to key in initial zeros when entering a parameter number: for example, for P005, key in **5**.

1. Press **PROGRAM**  then **DISPLAY** , to activate **PROGRAM** mode.



2. Either use the **ARROW** keys   to scroll to a different parameter, or:



3. Press **DISPLAY**  to open the Parameter Number field.



4. Key in the desired parameter number followed by **ENTER** .

For example: press  .



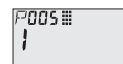

The LCD displays the new parameter number and value.



Changing a Parameter Value

Notes:

- Security must be disabled to enable programming: set P000 to the Unlocked Value stored in P069.
- Invalid entries will be rejected or limited.
- **CLEAR** [c] can be used to clear the field.

1. Use the **ARROW** keys   to scroll to the parameter number, or press **DISPLAY**  and key in the parameter number followed by **ENTER** .
2. Key in the new value.
3. Press **ENTER**  to set the value.

Parameter Reset to Factory Default

1. Scroll to the parameter or enter its address.
2. Press **CLEAR** [c] then **ENTER** . The value returns to the default setting.

P999 Master Reset

Note: Following a Master Reset, complete reprogramming is required.

Resets all parameters to their factory settings, with the following exceptions:

- P000 and P069 are not reset.
- P838 is not reset (the learned TVT curve is not lost).

1. Press **PROGRAM**  then **DISPLAY**  to activate **PROGRAM** mode.
2. Press **DISPLAY**  to open parameter fields.
3. Key in **999**.

Press **CLEAR** [c] then **ENTER** , to Clear All and initiate reset. The LCD displays **C.ALL**



4. Reset complete. (Reset takes several seconds to complete.)



Using Units or Percent (%)

Many parameters can be viewed either as a percentage, or in measurement units (P005). View the parameter, then press **MODE**  to toggle between units and percentage.



Quick Setup for local operation (outline)

Set the Quick Start parameters between P001 and P010 (the main settings that apply to all applications and make the system operational). Then set P837 and P838 to ignore false echoes, and return to **RUN** mode.

1. Select a language option, or numeric, for the auxiliary reading (P010).
2. Select the measurement mode: level, space, or distance (P001).
3. Set the response time to level changes (P003).
4. Select units of measurement: m, cm, mm, ft, or in. (P005).
5. Set process empty level (Empty: P006).
6. Set the range to be measured (Span: P007).
7. To ignore false echoes before the material echo, set Auto False-Echo Suppression Distance (P838).
8. Enable Auto False-Echo Suppression (P837).
9. Return to **RUN** mode.

Setup Instructions

Notes:

- In **PROGRAM** mode, you can use the **ARROW** keys   to scroll to a parameter number.
- The default parameter values are indicated by an asterisk (*) in the tables.

Using the handheld programmer, set each parameter value to suit your application. (For detailed instructions on accessing a parameter and changing the value, see page 22.)

1. Select a language¹ (P010: Language)

If a language is selected, parameter titles for the Quick Start parameters are displayed in the auxiliary reading field.

Parameter	Value	Description
P010	0	* Numeric/None
	1	English
	2	German
	3	French
	4	Spanish

Parameter	Auxiliary reading
P000	LOCK
P001	OPERATION
P003	MEAS RESP
P004	ANTENNA
P005	UNITS
P006	EMPTY
P007	SPAN
P010	LANGUAGE

2. Select the measurement mode required for the application (P001: Operation)

To measure how full the vessel is, select **Level**: the reading can be returned as level or as volume:

- for a level reading, ensure P050 is set to **0**: the reading returns the distance from process empty level (Empty) to the current level
- for a volume reading, select a vessel shape at P050, and set volume parameters P051 to P055 as required

To measure how much space remains in the vessel, select **Space**:

- **Space** returns a reading for the distance between current level and process full level (Span)

To measure the distance from the reference point² to the current level, select **Distance**.

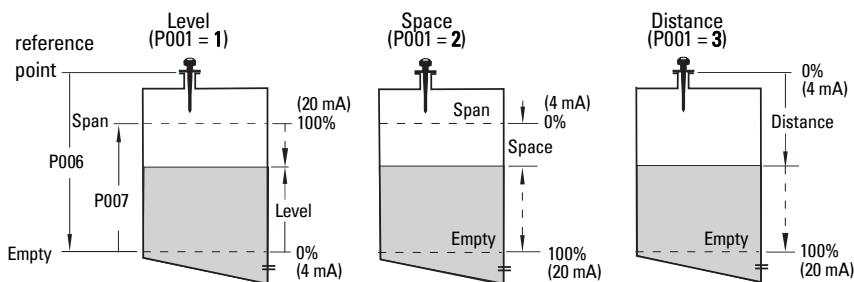

¹ The parameter title appears in the language selected, for parameters P000 to P010.

² For the reference point, see *SITRANS Probe LR: Dimensions* on page 15.

Notes:

- Setting P001 resets Span (P007), unless Span has previously been set to a different value. Span is set to Empty distance minus 110% of Blanking², unless Operation is set to distance measurement (P001 = 3). In this case, Span is set to the same value as Empty (P006).
- Changing P001 may reset Output Function (P201): this applies to HART only.

Parameter	Values	Description
P001	1	* Level returns material level referenced from Empty (process empty level). The reading is returned in volumetric units if parameters P050 to P055 are set to enable this.
	2	Space returns material level referenced from Span (process full level).
	3	Distance returns material level referenced from the reference point ² .

3. Set response time to filling/emptying rate (P003: Measurement Response)

Set P003 to a measurement response speed just faster than the maximum filling or emptying rate (whichever is greater).

Parameter	Values	Description	Parameters affected by P003
P003	1	* slow	0.1m/minute
	2	medium	1m/minute
	3	fast	10m/minute
			P070, P700, P701, P709, P711

Use a setting just faster than the maximum filling or emptying rate (whichever is greater). Slower settings provide higher accuracy: faster settings allow for more level fluctuation.

(For more detail on measurement response, see *Transceiver*, page 92.)

(P004 Antenna Type: view only)

Value		
240		rod antenna

¹ Default blanking distance is 0.3 m (1 ft). For more details, see *Near Blanking* on page 93.

² For the reference point for the standard configuration, see page 15.

4. Select the measurement units required (P005: Units)

Parameter	Value	Description
P005	1	* meters
	2	centimeters
	3	millimeters
	4	feet
	5	inches

5. Set process empty level (P006: Empty)

Value	Range	0.0000 to 20.00
	Default	20.00 m (maximum range)

Enter the distance from the antenna reference point¹ to process empty level (Empty), using units set in P005. Empty can be set to any distance: not necessarily the bottom of the vessel

Note:

- P006 and P007 are interlinked: see notes attached to P007.

6. Set the range to be measured (P007: Span)

Value	Range	0.0000 to 20.00
	Default	19.56 (see note below)

Enter the distance between Empty (process empty level) and Span (process full level), in the units set in P005. Span can be set at any distance above Empty level.

Notes:

- Setting P006 resets Span, if it has not previously been set to a different value.
- The default setting for Span is based on Operation (P001) and Empty (P006). Span is set to Empty minus 110% of Blanking distance², unless Operation is set to **distance** (P001=3). In this case, Span is set to Empty distance.
- Always prevent the monitored surface from approaching within 0.3 m (1 ft) of the reference point, as this is the minimum distance detectable.

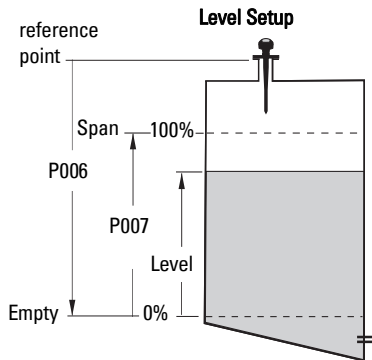

¹ For the reference point, see *SITRANS Probe LR: Dimensions* on page 15.

² 0.3 m (1 ft), plus the shield length (if any).

7. Minimize false reflections (P838: Auto False-Echo Suppression Distance)

Notes:

- P838 and P837 should be used together to adjust the TVT (Time Varying Threshold) curve.
- Use this function only if there is at least 2 m (6.5 ft) from the reference point to the material.
- Set P837 and P838 during start up, if possible.
- If the vessel contains an agitator, the agitator should be running.

If SITRANS Probe LR displays an incorrect full level, or if the reading fluctuates between a false high level and a correct level, you can use the TVT shaper parameters P838 and P837 together to prevent false-echo detection. They elevate the TVT in this region and desensitize the receiver from any "base noise" caused by internal antenna reflections, nozzle echoes, or other vessel false echoes¹.

P838 allows you to set a distance, within which SITRANS Probe LR will learn a new echo profile. Set P838 in combination with P837: see the Setup Instructions below.





Parameter	Values	
P838	Range:	0.0000 to 20.00 m (6.5 ft) maximum range
	*	1.000

8. Enable False-Echo Suppression (P837: Auto False-Echo Suppression)

P837 instructs SITRANS Probe LR to learn the echo profile at that moment, and use the learned profile instead of the default TVT curve (see examples on next page).

Parameter	Values	Description
P837	0	Off
	1	* Use "learned" TVT
	2	"Learn"

Setup Auto False-Echo Suppression:

- Perform this function when the vessel is empty or nearly empty.
- First rotate the instrument for best signal (lowest false-echo amplitude)
- Determine distance from reference point to material level and subtract 0.5 m (1.6 ft).
- Press **PROGRAM** , then **DISPLAY** .
- Select P838, key in [distance to material level minus 0.5 m/1.6 ft], and press **ENTER** .
- Select P837.
- Press **2** and then press **ENTER** . P 837 will automatically revert to **1** (use Learned TVT) after a few seconds.

9. Press **PROGRAM** to return to RUN mode.

¹ For more details, see *False-Echo Suppression* on page 94

Display before Auto False-Echo Suppression (or when P837 = 0)

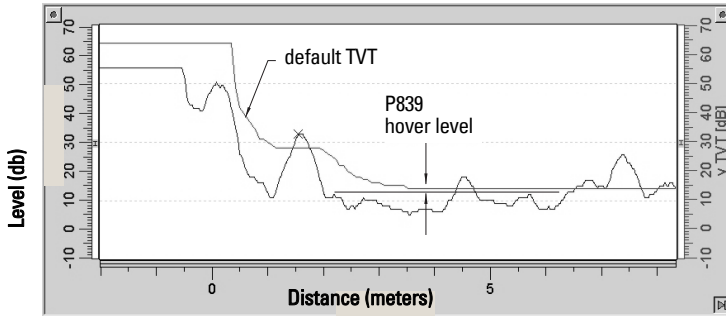

Example After Auto False-Echo Suppression

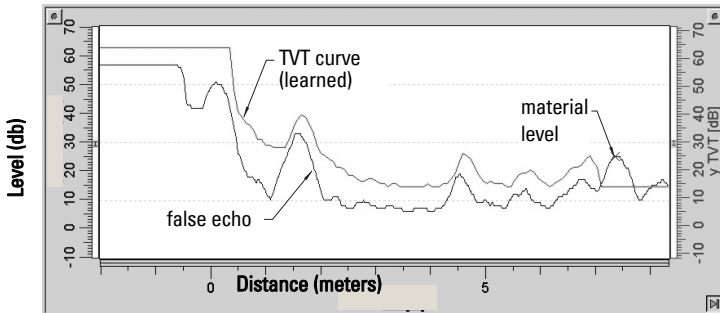

Additional Settings

- Convert readings to volume (P050 to P055)
- Stored unlock value (P069)
- Set Failsafe timer conditions (P070 to P073)
- Control Analog Output (P201 to P215, and P911)
- Check installation records (P341 to P346)
- Calibrate sensor for unusual conditions (P652 to P655)
- Limit rate of change of reading (P700 to P701)
- Verify measurements (P709 to P713)
- Configure communications (P799)
- Control echo processing (P800 to P820)
- TVT curve adjustments - Auto False-Echo Suppression (P831 to P839)
- Software diagnostic tests (P900 to P901)
- Adjust measurements (P911 to P924)

For a full list of available parameters, see *Parameter Reference*, starting on page 35.

Application Examples

You can use these examples as setup references. Enter the values in the parameter tables to select the corresponding functions.

Example 1: Liquid resin in storage vessel, level measurement

Notes:

- The minimum distance from the flange face to the target is limited by Near Blanking P800.
- Only set P837 if the product is at least 2 m (78") away from the flange face. If it is closer, leave P837 at 1 until the level drops and the distance increases beyond 2 m (78").

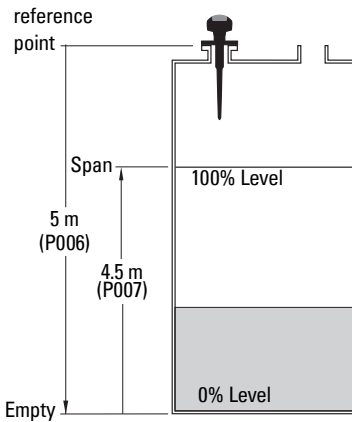

The application is to obtain a level measurement and corresponding 4 to 20 mA output proportional to resin levels in a storage vessel. (Units selected are meters.)

Process empty level (Empty) is the bottom of the tank, which is 5 m from the antenna flange face. Process full level (Span) is 4.5 m from the vessel bottom. The maximum rate of filling or emptying is about 0.2 m/min.

In the event of a loss of echo, SITRANS Probe LR is to go into Failsafe Hi after 2 minutes.

Parameter	Description	Value	Function
P001	mode of measurement	1	Level
P003	measurement response	2	1 m/minute
P005	units	1	meters
P006	empty distance	5	5 m
P007	span	4.5	4.5 m
P070	Failsafe timer	2	2 minutes
P071	Failsafe mode	1	Hi
P838	Auto False-Echo Suppression Distance	[Distance ^a minus 0.5 m]	Sets length of learned TVT curve ^b to use
P837	Auto False-Echo Suppression	2, then 1	Enables the use of learned TVT curve ^b .

- a. Distance to product from reference point.
- b. For more details on setting P837 and P838, see page 64. For an explanation, see *Auto False-Echo Suppression* on page 94.

Return to **RUN**: press **PROGRAM**  to start normal operation.

Example 2: Horizontal vessel with volume measurement

Notes:

- The minimum distance from the flange face to the target is limited by Near Blanking P800.
- Only set P837 if the product is at least 2 m (78") away from the flange face. If it is closer, leave P837 at **1** until the level drops and the distance increases beyond 2m (78").

The application is to obtain a level measurement and corresponding 4 to 20 mA output proportional to vessel volume in a chemical vessel.

Process empty level (Empty) is the bottom of the tank, which is 3.5 m from the antenna flange face. Process full level (Span) is 3.0 m from the vessel bottom. The maximum rate of filling or emptying is about 0.2 m/min. Selecting tank shape 7 at P050, and entering values for A and L, will give a volume reading instead of level.

In the event of a loss of echo, SITRANS Probe LR is to go into Failsafe Hi after 2 minutes.

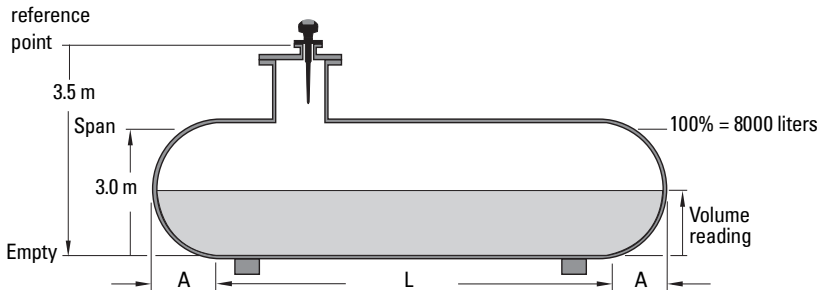

Parameter	Description	Values	Function
P001	mode of measurement	1	Volume replaces Level when a tank shape is selected at P050
P003	measurement response	2	1m/minute
P005	units	1	meters
P006	empty distance	3.5	3.5 m
P007	span	3	3 m
P050	vessel shape	7	parabolic ends
P051	maximum volume	8000	8000 liters
P052	vessel dimension A	.8	0.8 meters
P053	vessel dimension L	6	6 meters
P070	Failsafe timer	2	2 minutes
P071	Failsafe	1	Hi
P838	Auto False-Echo Suppression Distance	[Distance ^a minus 0.5 m]	Sets length of learned TVT curve ^b to use
P837	Auto False-Echo Suppression	2, then 1	Enables the use of learned TVT curve ^b .

- a. Distance to product from reference point.
- b. For more details on setting P837 and P838, see page 64. For an explanation, see *Auto False-Echo Suppression* on page 94.

Return to **RUN**: press **PROGRAM**  to start normal operation.

Notes

Parameter Reference

Notes:

- Keep infrared devices such as laptops, cell phones, and PDAs, away from SITRANS Probe LR to prevent inadvertent operation.
- Do not use the Handheld Programmer at the same time as SIMATIC PDM, or erratic operation may result.

SITRANS Probe LR is configured through its parameters, and the application determines the parameter values which are entered into the instrument.







Please check your value entries carefully before operating SITRANS Probe LR, to ensure optimum performance.

Helpful Hints

- **Default** values are indicated with an asterisk (*) in the parameter tables, unless explicitly described.
- **Primary index** is an address: for example, P054.
- **Secondary index** is a sub-address that allows for multiple values on an indexed point, and allows indexed values from more than one parameter to be linked, for example, the breakpoints in P054 and P055.



To access a parameter and change a value (primary index):







Note: Initial zeros in a parameter number do not have to be entered: for example, for P001, key in 1.

1. Press **PROGRAM**  then **DISPLAY**  to activate **PROGRAM** Mode.
2. Either use the **ARROW** keys   to scroll to each parameter number, or press **DISPLAY**  again to access the parameter number field and key in the parameter number followed by **ENTER** .
3. Key in the new value.
4. Press **ENTER** .

To access a secondary index and change a value:

Notes:

- In a parameter with a secondary index, the **ARROW** keys   control whichever index was most recently changed.
- When you first access a parameter, the **ARROW** keys control the primary index (parameter number).
- After the secondary index is changed, the **ARROW** keys control the secondary index.
- When the primary index is changed, the **ARROW** keys revert to the primary index.

1. Select the parameter number, for example P054: the secondary index is displayed in the auxiliary reading.
2. Press **DISPLAY**  twice¹ (the auxiliary reading field goes blank).
3. Key in the address of the desired index, or use the **ARROW** keys   to scroll to the desired secondary index number, then press **ENTER** .
4. Key in the new index value and press **ENTER** .
5. Press **DISPLAY**  twice, then use the **ARROW** keys or key in the parameter number to select a different parameter.

¹. This focusses control on the secondary index.

P000 Lock

Note:

- This lock only applies to the handheld programmer: it does not lock access through communications.
- A remote master can change configuration if P799 is set to allow this.

Secures SITRANS Probe LR from parameter changes via the handheld programmer.

Value	Unlocked Value (P069)	*	Unlocked: programming permitted ^a
	other		

- ^a. The factory setting for P069 is 1954: after a new Unlocked value is entered and accepted, the new value becomes the default setting.

To secure the programming lock:

1. Key in **0**, and press **ENTER** .
2. Key in any value other than the Unlocked Value (P069).
3. Press **ENTER** to set the value: **PROGRAM** mode is now active for viewing only.

To unlock the instrument and enable programming changes:

1. Key in **0**, and press **ENTER** .
2. Key in the Unlocked Value (P069).
3. Press **ENTER** to set the value: **PROGRAM** mode is now active for programming.

Quick Start (P001 to P010)

P001 Operation

Note: Default values are indicated with an asterisk (*) in the parameter tables, unless explicitly described.

Sets the type of measurement required for the application. (This affects the local LCD only; the primary variable for HART is controlled by P201.)

To measure how full the vessel is, select **Level**. The reading can be returned as level or as volume:

- for a level reading, ensure P050 is set to **0**: the reading returns the distance from process empty level (Empty) to the current level
- for a volume reading, select a vessel shape at P050, and set volume parameters P051 to P055 as required

To measure how much space remains in the vessel, select **Space**:

- **Space** returns a reading for the distance between current level and process full level (Span)

To measure the distance from the reference point¹ to the current level, select **Distance**.

Values	1	*	Level returns material level referenced from Empty (process empty level). The reading is returned in volumetric units if parameters P050 to P055 are set to enable this.
	2		Space returns material level referenced from Span (process full level).
	3		Distance returns material level referenced from the reference point ¹ .

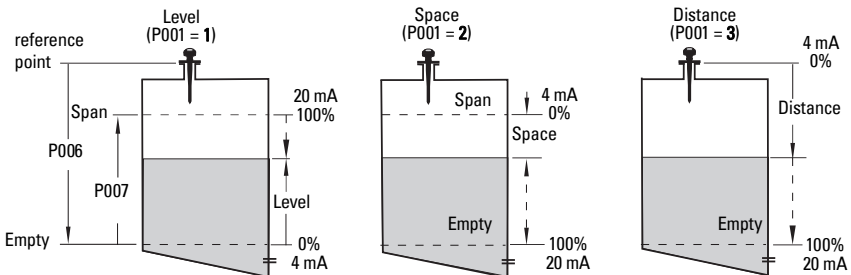

¹ For the reference point, see *SITRANS Probe LR: Dimensions* on page 15.

Notes:

- Setting P001 resets Span (P007), unless Span has previously been set to a different value. Span is set to Empty distance minus 110% of Blanking¹ unless P001 is set to 3 (distance measurement). In that case it is set to the same value as Empty (P006).
- Changing P001 may reset Output Function (P201). This applies to HART only.

P003 Measurement Response

Sets the rate of response to level changes.

Related Parameters	P003		Failsafe Timer P070 (minutes)	Max. Measurement Response P700/P701	Damping Filter P709	Echo Verification P711	
	Values	1	*	slow	100	0.1 m/minute	10.0 s
2			medium	10	1 m/minute	10.0 s	2
3			fast	1	10 m/minute	1.0 s	2

Note: Changing P003 resets the following parameters: P070, P700, P701, P709, and P711.

Use a setting just faster than the maximum filling or emptying rate (whichever is greater). Slower settings provide higher accuracy: faster settings allow for more level fluctuation.

- **Echo Verification (P711):** discriminates between agitator blades in motion (spurious noise) and the target surface (true echo).
- **Failsafe timer (P070):** establishes the period from the time a loss of echo (LOE) starts until the Failsafe default (P071) is triggered. P070 takes precedence over P003.

P004 Antenna Type

Specifies the antenna type attached.

Values	240	*	rod antenna
--------	-----	---	-------------

¹ See *Near Blanking* on page 93 for more details.

P005 Units

Specifies measurement units used for dimensional values.

Values	1	*	meters
	2		centimeters
	3		millimeters
	4		feet
	5		inches

P006 Empty (process empty level)

Sets the distance from the reference point¹ to the process empty level, in units selected at P005.

Values	Range	0.0000 to 20.00 (m)
	Default	20.00 m (max. range)

Enter the distance from the reference point to Empty (process empty level), using units set in P005. Empty can be set to any distance: not necessarily the bottom of the vessel

Notes:

- Default setting is maximum range.
- P006 and P007 are interlinked: see note attached to P007.

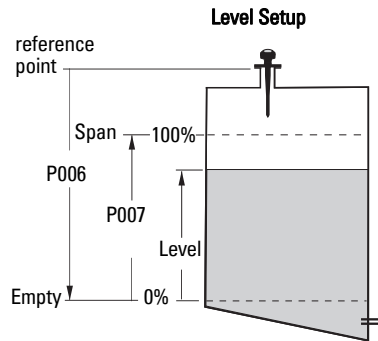

¹ For the reference point, see *SITRANS Probe LR: Dimensions* on page 15.

P007 Span (process full level)

Sets the range to be measured (referenced from Empty) in units selected at P005.

Values	Range	0.0000 to 20.00 (m)
	Default	19.56 (see note below)

Enter the distance between Empty (process empty level) and Span (process full level), in units set in P005. Span can be set at any distance above Empty level.

Notes:

- Setting P006 will reset Span, if it has not previously been set to a different value.
- The default setting for Span is based on Operation (P001) and Empty (P006). Span is set to Empty minus 110% of Blanking¹ distance, unless Operation is set to **Distance** (P001 = 3). In this case, Span is set to Empty distance.
- Always prevent the monitored surface from approaching within 0.3 m (1 ft) of the reference point, as this is the minimum distance detectable.

P010 Language

Selects the language used for the auxiliary reading on the display.

Values	0	*	Numeric / None
	1		English
	2		German
	3		French
	4		Spanish

If a language is selected, parameter titles for the parameters P000 to P010 are displayed. (See the table on page 25 for the titles displayed.)

¹. See *Near Blanking* on page 93 for details.

Volume (P050 to P055)

Note: Factory settings are indicated by an asterisk (*) in the parameter tables, unless explicitly described.

Set SITRANS Probe LR to calculate readings based on reservoir volume instead of level.

1. Operation must be set to Level (P001 = 1).
2. Select a vessel shape matching the monitored vessel (P050).
3. If required, add dimensions A or L (as shown in the chart on page 43), using P052 and P053,
or, if vessel shape 9 is selected, add level and volume breakpoints in P054 and P055.
4. Enter the value for the maximum vessel volume in P051.
5. Return to **RUN** mode: readings are now displayed in volumetric units. To select **PERCENT**, press $\left[\frac{\%}{\%} \right]$; the displayed volume reading will be a percentage of Maximum Volume.

P050 Vessel Shape

Defines the vessel shape (see chart on next page) and allows SITRANS Probe LR to calculate volume instead of level. The default setting for P050 is 0 (volume calculation not required).

Enter the value for the vessel shape matching the monitored vessel or reservoir (see chart on page 43).

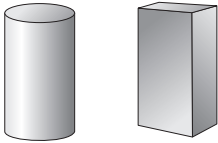
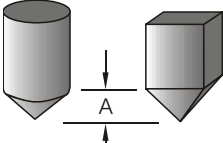
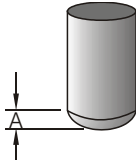
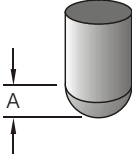
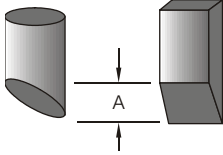
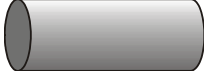
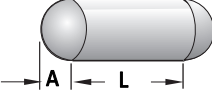
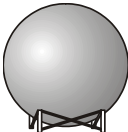
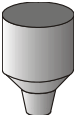
P050 Value	Vessel Shape	Description	Also required	
0	*	----	no volume calculation required	N/A
1		flat bottom	P051	
2		conical or pyramidal bottom	P051, P052	
3		parabolic bottom	P051, P052	
4		spherical bottom	P051, P052	
5		angled bottom	P051, P052	
6		flat end cylinder	P051	
7		parabolic end cylinder	P051, P052, P053	
8		sphere	P051	
9		universal linear level/volume breakpoints	P051, P054, P055	

P051 Maximum Volume

For readings in volumetric units instead of percentage values, enter the vessel volume between Empty (P006) and Span (P007). Any volumetric units can be chosen, because the volume calculation is based on the maximum volume, and scaled according to the Vessel Shape (P050) value. If no value is entered, the default is 100, and the reading will be a percentage value.

Values	Range	0.0000 to 99999
	Default	100.0
Related Parameters	P006 Empty P007 Span	

Enter the vessel volume between Empty (P006) and Span (P007).

1. Key in the value. (For example, if maximum volume = 3650 m³, key in 3650.)
2. Press **ENTER** .

If the value is too large for the LCD display, enter larger units.

Example:

If maximum volume = 267,500 gallons, key in **267.5** (thousands of gallons).

P052 Vessel Dimension A

Dimension A as used for P050 Vessel Shapes 2, 3, 4, 5, or 7, in the chart on page 43).

Values	Range	0.0000 to 99999 in units (P005)
	Default	0.0
Related Parameters	P050 Vessel Shape	

Enter one of the following, using the units selected in P005:

- height of the vessel bottom if P050 = **2, 3, 4, or 5**
- length of one end-section of the vessel if P050 = **7**

P053 Vessel Dimension L

Dimension L as used in P050 Vessel Shape, in the chart on page 43).

Values	Range	0.0000 to 99999 in units (P005)
	Default	0.0
Related Parameters	P050 Vessel Shape	

Enter the vessel length **L** (excluding both end sections) if P050 = **7**. Use the units selected in P005.

P054 Level Breakpoints

When the vessel shape is too complex for any of the preconfigured shapes, you can define the shape as a series of segments. In P054 you assign a level value to each breakpoint. In P055 you assign a corresponding volume value to each breakpoint.

Primary Index	P054	
Secondary Index	Breakpoint number	
Values	Range	0.0000 to 99999 in units (P005)
	Default	0.0
Related Parameters	P055 Volume Breakpoints	

Enter up to 32 level breakpoints, where the corresponding volume is known. The 100% and 0% levels must be entered. The breakpoints can be ordered from top to bottom, or the reverse.

1. First set P050 to **9**.
2. Select P054.
3. The empty breakpoint value field appears, with the breakpoint number 01 in the auxiliary reading.
4. Key in the level value for breakpoint 1, and press **ENTER** . (Use units defined in P005.)
5. Press **DISPLAY** twice to focus control on the secondary index.
6. Press the **UP ARROW** key to display 02 in the auxiliary reading.
7. Key in the level value for breakpoint 2, and press **ENTER** . (Use units defined in P005.)
8. Repeat steps 6 and 7 until level values have been entered for all the required breakpoints.

Example:

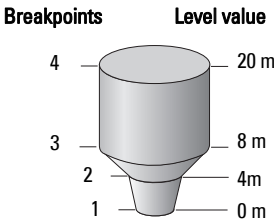

Breakpoint Number	Level breakpoint (P054)	Volume breakpoint (P055)
1	0	0
2	4	500
3	8	3000
4	20	8000

P055 Volume Breakpoints

Each segment defined by the level breakpoints (P054) requires a corresponding volume for SITRANS Probe LR to make the level-to-volume calculations.

Primary Index	P055	
Secondary Index	Breakpoint number	
Values	Range	0.0000 to 99999 in units
	Default	0.0000
Related Parameters	P054 Volume Breakpoints	

Typical volume calculations:

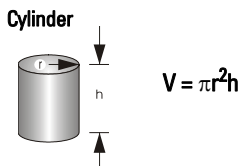
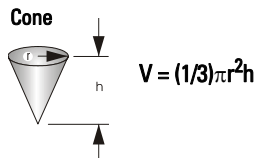

Enter a volume for each breakpoint defined in P054. (See illustrated example for P054 on the previous page.)

1. First set P050 to **9**.
2. Select P055.
3. The empty breakpoint value field appears, with the breakpoint number 01 in the auxiliary reading.
4. Key in the volume for breakpoint 1, and press **ENTER** . (Any volumetric units can be used: see note to P051.)
5. Press **DISPLAY** twice to focus control on the secondary index.
6. Press the **UP ARROW** key to display 02 in the auxiliary reading.
7. Key in the volume for breakpoint 2, and press **ENTER** .
8. Repeat steps 5 and 6 until volume values have been entered for all the required breakpoints.

Lock (P069)

P069 Unlocked value

Stores the value to enter in Lock (P000) to unlock programming. If P000 is locked, P069 will not display the Unlocked value.

Values	Range	1 to 9999
	Factory setting	1954
	----	Display when P000 is locked

Notes:

- Default setting for P000 is unlocked.
- After a new value has been stored at P069, that value will be recalled after a master reset (P999).
- Consult your Siemens representative, if you have forgotten the unlocked value.

Failsafe (P070 to P073)

Note: Factory settings are indicated by an asterisk (*) in the parameter tables, unless explicitly described.

P070 Failsafe Timer

Note: The last valid reading is maintained until the Failsafe timer expires. After the timer expires, the reading is set based on P071.

Sets the time to elapse in minutes since the last valid reading, before Failsafe State activates.

Values	Range	0.00 to 720 min.
	Default	100.0 (based on P003)

P071 Failsafe Material Level

The material level to be reported when the Failsafe Timer expires. (For more detail, see Failsafe on page 97.)

Values	1		Use Maximum mA Limit (P213) as material level
	2		Use Minimum mA Limit (P212) as material level
	3	*	Level remains at last reading
	4		User-selected value (defined in P073)

1. Enter the value corresponding to the level you want reported when the Failsafe Timer expires.
2. Press **ENTER** .

P073 Failsafe level

Note: P071 must be set to **User-selected value (4)** to use this value.

Defines a user-defined level to report when the Failsafe timer expires.

Values	Range	3.6 mA to 22.6 mA
	Default	22.6 mA

mA Output (P201 to P215)

Note: Factory settings are indicated by an asterisk (*) in the parameter tables, unless explicitly described.

P201 mA Output Function

Alters the mA output/measurement relationship, and allows the output to be set independently from P001. If a HART master is connected, only the master can change the value.

Values	0		manual
	1	*	level
	2		space
	3		distance
	4		volume (only available if a tank shape has been selected at P050)

Notes:

- P201 is set independently from P001: set P001 first, as changing P001 will reset P201 to the same setting.
- P201 controls the primary value and the loop current for the HART common module and should not be changed if using HART.
- Selection also affects the secondary, tertiary, and quaternary variables for HART.
- P201 must be set to **0** (manual) before you can modify P911. Remember to restore the previous setting after using P911.

Independent mA Setpoint Parameters (P210 and P211)

Note: Factory settings are indicated by an asterisk (*) in the parameter tables, unless explicitly described.

P210 and P211 allow you to explicitly define the normal operating range. Use these features to reference the minimum and/or maximum mA output to any point in the measurement range.

For HART, 4 mA and 20 mA represent the upper and lower range limits for the primary variable.

P201 (mA Function) Settings	Response for P210 and P211
Level, Space, or Distance	Key in the material level in Units (P005) or percent ^a of Span (P007) as referenced from Empty (P006).
Volume	Key in the volume in Maximum Volume (P051) units or as a percent ^a of Maximum Volume.

- ^a Ensure the % symbol is displayed before entering a % value.

P210 4 mA Setpoint (low output)

Note: P210 is used to set the 4 mA loop current for the HART common module.

Sets the process level corresponding to the 4 mA value. 4 mA always defaults to 0, and P201 determines whether this is a Level, Space, Distance, or Volume measurement. Level and Space are measured as a percentage of Span; Distance is measured as a percentage of Empty.

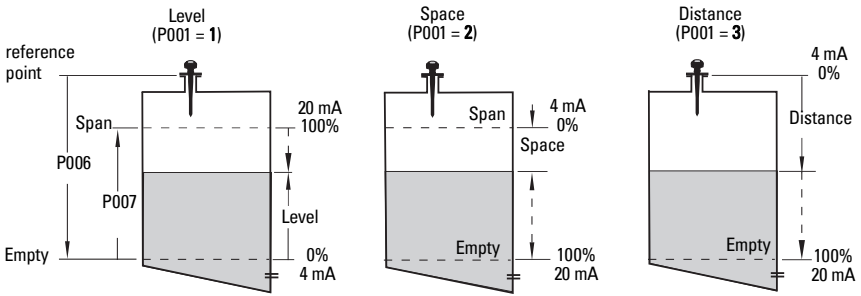

Values	Range	-99999 to 99999
	Default	0.000 m (set to 0% as defined by P201: mA Output Function)
Related Parameters	P201: mA Output Function	

Enter the reading that is to correspond to a 4 mA output. Use percent or units, depending on the setting for P051.

P211 20 mA Setpoint (high output)

Note: P211 is used to set the 20 mA loop current for the HART common module.

Sets the process level corresponding to the 20 mA value. 20 mA always defaults to 100%, and P201 determines whether this is a Level, Space, or Distance measurement. Level and Space are measured as a percentage of Span; Distance is measured as a percentage of Empty.

Values	Range	-99999 to 99999
	Default	19.56 m (set to 100% as defined by P201: mA Output Function)
Related Parameters	P201: mA Output Function	

Enter the reading that is to correspond to a 20 mA output. Use percent or units, depending on the setting for P051.

mA Output Limit Parameters (P212 and P213)

Note: Factory settings are indicated by an asterisk (*) in the parameter tables, unless explicitly described.

P212 and P213 allow you to explicitly set a failsafe current outside the normal operating range.

P212 Minimum mA limit

Prevents the mA output from dropping below this minimum level for a measurement value. This does not restrict the Failsafe or manual settings.

Values	Range	3.8 to 20.5 (mA)
	Default	3.8 (mA)

P213 Maximum mA limit

Prevents the mA output from rising above this maximum level for a measurement value. This does not restrict the Failsafe or manual settings.

Values	Range	3.8 to 20.5 (mA)
	Default	20.5 (mA)

P214 4 mA Output Trim

Note: This parameter is for use only by Siemens service personnel.

Calibrates the 4 mA output.

P215 20 mA Output Trim

Note: This parameter is for use only by Siemens service personnel.

Calibrates the 20 mA output.

Installation Records (P341 to P346)

Note: Factory settings are indicated by an asterisk (*) in the parameter tables, unless explicitly described.

P341 RUN Time

Displays the number of uninterrupted 24 hour periods that the device has been operating.

Values (view only)	Range	0 to 99999 (days)
	Default	0
Related parameters	P342 Power-on Resets	

P341 is updated once a day.

- If power is cycled before 24 hours have passed, the run time will not be updated.
- If an instrument is powered down on a regular basis, P341 will not have an accurate value.

P342 Power-On Resets

The number of times power has been applied since the date of manufacture.

Values (view only)	Range	0.0 to 99999
Related parameters	P341 RUN Time	

This parameter is updated every time the instrument is reset or is powered up.

P343 Internal Temperature

! **WARNING: Internal temperature must not exceed 80 °C (176 °F).**

Displays (in degrees C) either the current temperature on the circuit board, or the maximum or minimum temperature recorded by the internal sensor. The high and low values are maintained over a power cycle.

Values (view only)	Range	-50 °C to 150 °C
	1	Current temperature
	2	Maximum temperature
	3	Minimum temperature

P346 Serial Number

Displays the serial number of the instrument. The numbers stored in Index 2, followed by the numbers stored in Index 1, give you the complete serial number.

	Index 2	Index 1	
Values (view only)	Range: 00000 to 99999	Range: 00000 to 99999	
Example: 1503010	15	03	010

Range Calibration (P652 to P655)

Note: Factory settings are indicated by an asterisk (*) in the parameter tables, unless explicitly described.

P652 Offset Correction

A fixed offset value that is added to the reading as a correction to the measurement.

Values	Range	-99999 to 99999
	Default	0.000

P655 Propagation Factor

The value used to compensate for changes in microwave velocity due to propagation within a metal stillpipe, instead of in free space.

Values	Range	0.3000 to 1.5000
	Default	1.000

Pipe Size (I.D.)	Propagation Factor ^a
50 mm (2")	0.827
80 mm (3")	0.915
100 mm (4")	0.955
150 mm (6")	0.980
200 mm (8")	0.990

^aContact your Siemens representative for other sizes and propagation factor numbers.

The propagation factor is constant for a given pipe diameter, or can be determined by comparing the radar distance reading to the actual process material distance (measured from the reference point¹).

Example:

$$\frac{\text{actual distance}}{\text{SITRANS Probe LR distance}} = \text{p.f. (propagation factor)}$$

Using the readings shown:

$$\frac{10.42\text{m}}{12.6\text{m}} = 0.827$$

Enter the propagation factor: **0.827**

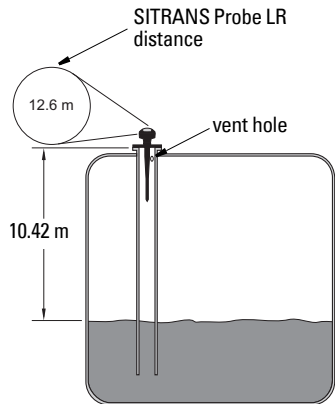

¹ For the reference point, see *SITRANS Probe LR: Dimensions* on page 15.

Rate (P700 and P701)

Note: Factory settings are indicated by an asterisk (*) in the parameter tables, unless explicitly described.

These parameters determine how material level changes are reported.

P700 Maximum Fill Rate

Allows you to further adjust the SITRANS Probe LR response to increases in the actual material level (or an advance to a higher Failsafe Material Level, P071). P700 is automatically updated whenever Measurement Response (P003) is altered.

Values	Range	0.0000 to 99999 m / min.
	Factory setting	0.1
Altered by	P003 Measurement Response	
Related parameters	P005 Units P007 Span P071 Failsafe Material Level	

Enter a value slightly greater than the maximum vessel-filling rate, in Units (P005) or percent of Span (P007) per minute.

P003 Value	Meters/Minute
1	0.1
2	1
3	10

P701 Maximum Empty Rate

Adjusts the SITRANS Probe LR response to decreases in the actual material level (or an advance to a lower Failsafe Material Level, P071). P701 is automatically updated whenever Measurement Response (P003) is altered.

Values	Range	0.0000 to 99999 m / min
	Factory setting	0.1
Altered by	P003 Measurement Response	
Related parameters	P005 Units P007 Span P071 Failsafe Material Level	

Enter a value slightly greater than the vessel's maximum emptying rate, in Units (P005) or percent of Span (P007) per minute.

P003 Value	Meters/Minute
1	0.1
2	1
3	10

Measurement Verification (P709 to P713)

Note: Factory settings are indicated by an asterisk (*) in the parameter tables, unless explicitly described.

P709 Damping Filter

Stabilizes the reported level within the Echo Lock Window (P713) in the event of level fluctuations (for example, a rippling or splashing liquid surface). The value is in seconds, and depends on the number of seconds it takes the device to reach 63% of a step value change in reading.

Values	Range	0 to 100 seconds (0 = off)
	Default	10.0 seconds
Altered by	P003 Measurement Response	
Related parameters	P007 Span P713 Echo Lock Window	

The value is automatically altered when Measurement Response Speed (P003) changes. The higher the value entered, the greater the range of stabilized fluctuation.

P711 Echo Lock

Note: Ensure the agitator is always running while SITRANS Probe LR is monitoring the vessel, to avoid stationary blade detection.

Use this feature to select the measurement verification process.

Values	0		Off
	1		Maximum Verification
	2	*	Material Agitator
	3		Total Lock
Related parameters	P700 Maximum Fill Rate P701 Maximum Empty Rate P712 Echo Lock Sampling P713 Echo Lock Window P820 Algorithm		

If a material agitator or mixer is used in the monitored vessel, set Echo Lock for Maximum Verification or Material Agitator, to avoid agitator blade detection.

- When Maximum Verification or Material Agitator is selected, a new measurement outside the Echo Lock Window (P713) must meet the sampling criterion (P712).
- When Total Lock is selected, Echo Lock Window (P713) is pre-set to **0**.

SITRANS Probe LR continuously searches for the best echo according to the algorithm chosen (P820). If the selected echo is within the window, the window is then centered about the echo. If not, the window widens with each successive shot until the selected echo is within the window. The window then returns to its normal width.

When Echo Lock is Off, SITRANS Probe LR responds immediately to a new measurement, as restricted by the Maximum Fill / Empty Rate (P700 / P701). However, measurement reliability is affected.

P712 Echo Lock Sampling

Note: Resetting P711 returns P712 to the respective pre-set values.

The sampling criterion sets the number of consecutive echoes that must appear above or below the echo currently locked onto, before the measurements are validated as the new reading. (Echo Lock P711 must be set to 1 or 2.

Values	Format	xy x = the number of above echoes y = the number of below echoes
	Range	1:1 to 50:50
Related parameters	P711 Echo Lock	

P711 default value		Description	P712 pre-set value
1		maximum verification	5:5
2	*	material agitator	5:2

Example:

- Set P711 to 2 (material agitator)
- The preset values for P712 in this case are 5:2
- Result: a new reading will not be validated unless 5 consecutive measurements higher or 2 consecutive measurements lower than the current reading occur.

P713 Echo Lock Window

Note: The echo lock window is stored as standard samples, but displayed in units based on P005. Any value entered for P713 will be rounded to the nearest sample.

Adjusts the size of the Echo Lock Window. This value is automatically altered when Measurement Response (P003), Maximum Fill Rate (P700), or Maximum Empty Rate (P701), are altered.

Values	Range	0.000 to 9999
	Default	0.000
Altered by	P003 Measurement Response	
Related Parameters	P005 Units P711 Echo Lock	

The Echo Lock Window is a "distance window"¹, centered on the echo used to derive the reading. When a new measurement falls within the window, the window is re-centered and the new reading calculated. Otherwise, the new measurement is verified by Echo Lock (P711) before the reading is updated.

¹ Units are those set in P005.

When the value is **0**, the window is automatically calculated after each measurement. The value is fixed at **0** if Echo Lock (P711) is set to **3**.

- For slower Measurement Response values (P003), the window is narrow.
- For faster P003 values the window becomes progressively wider.

P752 HART Address

Note: Accessible via the handheld programmer only by keying in P752.

Sets the device address or poll ID on a HART network. Any address other than 0 will cause the output current to be a fixed value, and the current will not indicate the reading.

Values	Range	0 to 15 Enter 0 for single transmitter installation; enter digit other than 0 for multi-drop applications. (Default: 0)
---------------	-------	---

Communications (P799)

P799 Communications Control

Enables the read/write access to parameters via remote communications.

Values	0		Read only
	1	*	Read/write
	2		Restricted access – read only except for P799 which is read/write

Notes:

- P799 controls the access if you are using a HART master.
- P000 controls the lock access if you are using the Siemens handheld programmer.

Echo Processing (P800 to P807)

Note: Factory settings are indicated by an asterisk (*) in the parameter tables, unless explicitly described.

The following parameters are for authorized Siemens Service personnel or technicians familiar with Siemens echo processing techniques. View the echo profile first, using SIMATIC PDM, before attempting to modify these parameters.

P800 Near Blanking ¹

Defines the distance from the reference point to be ignored by the transmitter/receiver.

Values	Range	0.00 to 20 (m: selected in P005)
	Default	0.30 m (plus the shield length)
Related parameters	P006 Empty P007 Span P838 Auto False-Echo Suppression Distance	

To extend the blanking beyond the minimum default, enter a value in units.

P801 Range Extension

Note: Maximum range extension depends on the setting for P006 (Empty).

Allows the material level to drop below Empty (process empty level), without generating an LOE state.

Values	Range	0 to 1000%
	Default	5.000 (% of Span)
Related Parameters	P006 Empty P007 Span	

Use this feature if the surface monitored can drop below Empty level (P006) in normal operation. The value for P801 is added to Empty, and the sum can be greater than the range of the antenna. Range Extension can be increased (in Units or percent of Span) to a point where Empty plus Range Extension is greater than the distance from the flange face to the furthest surface to be monitored. The distance below empty is not blanked.

- Enter the value as a percentage of P006.
- For vessels with conical or parabolic bottoms, increase the value for P801 to ensure that an empty vessel reads Empty.

¹ For more details, see *Near Blanking* on page 93.

P804 Confidence Threshold

Determines which echoes are evaluated by software.

Values	Range	0 to 99
	Default:	5
Related Parameters	P070 Failsafe Timer	

P804 sets the minimum echo confidence that the echo must meet in order to prevent a Loss of Echo condition and the expiration of the Failsafe timer (P070). When Echo Confidence (P805) exceeds the Confidence Threshold, the echo is evaluated.

P805 Echo Confidence

Measures echo reliability. It displays the echo confidence of the measurement echo from the last measurement. P804 defines the minimum criterion for echo confidence.

Values (view only)	Range	0 to 99
	----	Shot not used
Related Parameters	P804 Confidence Threshold	

Press the measurement key  to get a new reading that will update confidence values.

P806 Echo Strength

Displays the absolute strength (in dB above 1 μ V rms) of the echo selected as the measurement echo.

Values (view only)	Range	-20 to 99
---------------------------	-------	------------------

Press the measurement key  to get a new reading that will update echo strength.

P807 Noise

Displays the average and peak ambient noise (in dB above 1 μ V rms) of a noise profile, as x.y. Noise level is a combination of transient noise and receiving circuitry.

Values (view only)	Format	x.y x = average y = peak
	Range	-20 to 99
	Start up display	-15 . - 15

After a measurement, the values from the previous noise shot will be displayed. Press the measurement key  to get a new reading that will update the noise profile.

Algorithm (P820)

Note: Factory settings are indicated by an asterisk (*) in the parameter tables, unless explicitly described.

P820 Echo Algorithm

Selects the algorithm to be applied to the echo profile to extract the true echo.

Values	3		L argest echo
	4		Reserved
	8		best of L argest or F irst echo
	12	*	F irst echo

For more clarification on the different options, please contact your local representative.

TVT (Time Varying Threshold) Adjustment Parameters (P831 to P839)

Note: Factory settings are indicated by an asterisk (*) in the parameter tables, unless explicitly described.

First SITRANS Probe LR learns the echo profile. Then the learned profile, or part of the learned profile, is used to screen out false echoes.

The following parameters are for authorized Siemens Service personnel or technicians familiar with Siemens echo processing techniques. View the echo profile first, before attempting to modify these parameters.

P831 Manual TVT Shaper

Note: This parameter is for use only by Siemens service personnel.

Turns the TVT Shaper ON or OFF.

P832 Manual TVT Shaper Adjust

Note: This parameter is for use only by Siemens service personnel.

P837 Auto False-Echo Suppression

Notes:

- P837 and P838 should be used together to adjust the TVT (Time Varying Threshold) curve.
- Use this function only if there is a minimum distance of 2 meters (6.5 feet) from the reference point to the material.
- Set P837 and P838 during start up, if possible.
- If the vessel contains an agitator, the agitator should be running.

P837 instructs SITRANS Probe LR to learn the echo profile at that moment, and use the learned profile instead of the default TVT curve. (See next page for examples.)

Parameter	Values	Description
P837	0	Off
	1	* Use "learned" TVT
	2	"Learn"

If SITRANS Probe LR displays a full level, or if the reading fluctuates between a false high level and a correct level, you can use the TVT shaper parameters P837 and P838 together to prevent false-echo detection. They elevate the TVT in this region and de-sensitize the receiver from any 'base noise' caused by internal antenna reflections, nozzle echoes, or other vessel false echoes¹.

Setup instructions for P837 and P838 follow P838

P838 Auto False-Echo Suppression Distance





Allows you to set a distance within which SITRANS Probe LR will learn a new echo profile. (Units are defined in P005.)

Values	Range	0.000 to 20.00 m (65.6 ft): max. range
	Default	1.000 m

Follow the setup instructions for P837 and P838 on the next page.

¹ For more details, see *Auto False-Echo Suppression* on page 94.

P837 and P838 Setup Instructions:

1. Perform this function when the vessel is empty or nearly empty.
2. Rotate the instrument for best signal (lowest false-echo amplitude).
3. Determine distance from reference point to material level, and subtract 0.5 m/1.6ft.
4. Press **PROGRAM**  then **DISPLAY** .
5. Select P838, key in [distance to material level minus 0.5m/1.6 ft], and press **ENTER** .
6. Select P837.
7. Press **2** and then press **ENTER** . P837 will automatically revert to **1** (use Learned TVT) after a few seconds.
8. Press **PROGRAM**  to return to **RUN** mode.

Display before Auto False-Echo Suppression (or when P837 = 0)

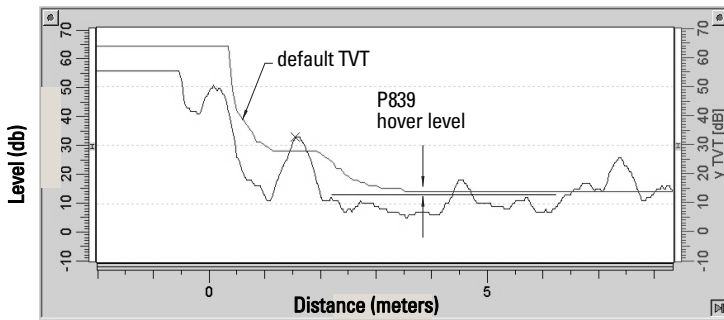

Example After Auto False-Echo Suppression

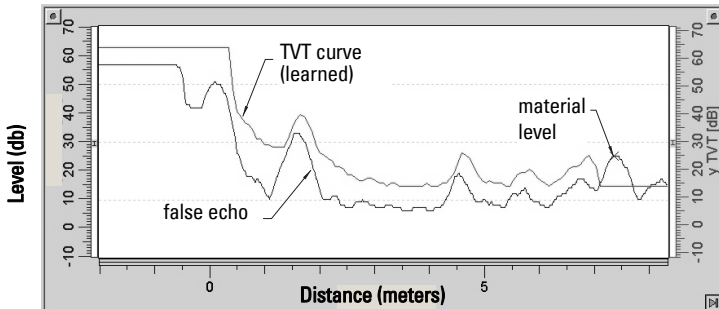

P839 TVT Hover Level

Defines (in percent) how high the TVT curve is placed above the profile, relative to the largest echo. When SITRANS Probe LR is located in the center of the vessel, lower this parameter to prevent multiple echo detections.

Values	Range	0 to 100%
	Default:	40

Test (P900 to P924)

Note: Factory settings are indicated by an asterisk (*) in the parameter tables, unless explicitly described.

P900 Software Revision Number

Displays the software revision level.

Values (view only)	Range	0.00 to 99.99
	1	Main code revision
	2	Primary boot revision
	3	Alternative boot revision
	3	Hardware stack revision
	Default	Determined by the software revisions installed

P901 Memory Test

Press ENTER  to activate the test.

Values (view only)	PASS	Memory test successful
	F1	Fail RAM
	F2	Fail EEPROM
	F3	Fail FLASH

Measurement

P911 mA Output Value (HART/mA only)

Access this parameter to display the current value of the mA output.

Values (HART)	Range	3.6 to 22.6 (mA)
	*	4 mA in HART fixed current mode

1. Set P201 to **0** (manual).
2. Enter a test value.

Note: P201 must be set to **0** to enable the test value to be entered at P911: be sure to restore P201 to the previous setting after the test!

P920 Reading Measurement

P920 corresponds to the final reading after all programming is applied. It is a copy of one of P921 to P924, depending on the setting for Operation (P001).

	Operation P001		Source Parameter for P920
	0	Off	----
	1	Level	P921 if P050 = 0 , otherwise P924
	2	Space	P922
	3	Distance	P923
P920 Values (read only)	Range:	-99999 to 99999 (dimensional units, if volume has not been selected)	

P921 Material Measurement

Displays the distance between Empty/process empty level (P006) and the monitored surface, in Units (P005) or percent of Span (P007).

Values (view only)	Range	-99999 to 99999
---------------------------	-------	------------------------

P922 Space Measurement

Displays the distance between the monitored surface and Span / process full level (P007).

Values (view only)	Range	-99999 to 99999
---------------------------	-------	-----------------

P923 Distance Measurement

Displays the distance between the monitored surface and the reference point¹.

Values (view only)	Range	-99999 to 99999
---------------------------	-------	-----------------

P924 Volume Measurement

Note: The display for P924 reads - - - -, when volume calculation is not enabled at P050 (P050 = 0).

The calculated vessel capacity in Maximum Volume (P051) or percent of Maximum Volume (volume calculation must be enabled at P050).

Values (view only)	Range	-99999 to 99999
Related Parameters	P051 Maximum Volume P050 Vessel Shape	

P999 Master Reset

Note: Following a Master Reset, complete reprogramming is required.

Resets all parameters to their factory settings, with the following exceptions:

- P000 and P069 are not reset.
- The learned TVT curve is not lost.

Use this feature after upgrading software:

1. Select P999.
2. Press **CLEAR**  then **ENTER**  to Clear All and initiate reset.
3. Reset complete.

(**Note:** Reset takes several seconds to complete.)



¹ For the reference point for the standard model, see *SITRANS Probe LR: Dimensions* on page 15.

Appendix A: Alphabetical Parameter List

Parameter Name	Parameter Number	Page Number
20 mA Setpoint (high output)	211	50
20 mA Output Trim	215	52
4 mA Output Trim	214	52
4 mA Setpoint (low output)	210	50
Antenna Type	004	39
Auto False-Echo Suppression	837	64
Auto False-Echo Suppression Distance	838	64
Level Breakpoints	054	45
Communications Control	799	59
Confidence Threshold	804	61
Damping Filter	709	56
Distance Measurement	923	68
Echo Algorithm	820	62
Echo Confidence	805	61
Echo Lock	711	57
Echo Lock Sampling	712	58
Echo Lock Window	713	58
Echo Strength	806	61
Empty / process empty level	006	40
Failsafe Level	073	48
Failsafe Material Level	071	48
Failsafe Timer	070	47
Internal Temperature	343	53
Language	010	41
Lock	000	37
mA Output Function	201	48
mA Output Value (HART / mA only)	911	67

Parameter Name	Parameter Number	Page Number
Master Reset	999	68
Material Measurement	921	67
Maximum Empty Rate	701	56
Maximum Fill Rate	700	55
Maximum mA limit	213	51
Maximum Volume	051	44
Measurement Response	003	39
Memory Test	901	66
Minimum mA limit	212	51
Near Blanking	800	60
Noise	807	62
Offset Correction	652	53
Operation	001	38
Power-on Resets	342	52
Propagation Factor	655	54
Range Extension	801	60
Reading Measurement	920	67
Serial Number	346	53
RUN Time	341	52
Software Revision Number	900	66
Space Measurement	922	68
Span / process full level	007	41
TVT Hover Level	839	66
TVT Shaper	831	63
TVT Shaper Adjust	832	63
Units	005	40
Unlocked Value	069	47

Parameter Name	Parameter Number	Page Number
Vessel Dimension A	052	44
Vessel Dimension L	053	44
Vessel Shape	050	42
Volume Breakpoints	055	46
Volume Measurement	924	68

Appendix B: Programming Chart

Parameter Number and Name	Value
P000 Lock	
P001 Operation	
P003 Measurement Response	
P004 Antenna Type	
P005 Units	
P006 Empty (process empty level)	
P007 Span (process full level)	
P010 Language	
P050 Vessel Shape	
P051 Maximum Volume	
P052 Vessel Dimension A	
P053 Vessel Dimension L	
P054 Level Breakpoints	
P055 Volume Breakpoints	
P069 Unlocked value	
P070 Failsafe Timer	
P071 Failsafe Material Level	
P073 Failsafe level	
P201 mA Output Function	
P210 4 mA Setpoint (low output)	
P211 20 mA Setpoint (high output)	
P212 Minimum mA limit	
P213 Maximum mA limit	
P214 4 mA Output Trim	

Parameter Number and Name	Value
P215 20 mA Output Trim	
P341 RUN Time	
P342 Power-On Resets	
P343 Internal Temperature	
P346 Serial Number	
P652 Offset Correction	
P655 Propagation Factor	
P700 Maximum Fill Rate	
P701 Maximum Empty Rate	
P709 Damping Filter	
P711 Echo Lock	
P712 Echo Lock Sampling	
P713 Echo Lock Window	
P799 Communications Control	
P800 Near Blanking	
P801 Range Extension	
P804 Confidence Threshold	
P805 Echo Confidence	
P806 Echo Strength	
P807 Noise	
P820 Echo Algorithm	
P831 Manual TVT Shaper	
P832 Manual TVT Shaper Adjust	
P837 Auto False-Echo Suppression	
P838 Auto False-Echo Suppression Distance	
P839 TVT Hover Level	
P900 Software Revision Number	

Parameter Number and Name	Value
P901 Memory Test	
P911 mA Output Value (HART/mA only)	
P920 Reading Measurement	
P921 Material Measurement	
P922 Space Measurement	
P923 Distance Measurement	
P924 Volume Measurement	
P999 Master Reset	

Appendix C: HART

HART Communications for SITRANS Probe LR

Highway Addressable Remote Transducer, HART, is an industrial protocol that is superimposed on the 4-20 mA signal. It is an open standard, and full details about HART can be obtained from the HART Communication Foundation at www.hartcomm.org

SITRANS Probe LR can be configured over the HART network using either a HART handheld Communicator, or a software package. There are a number of different software packages available. The recommended software package is the SIMATIC Process Device Manager (PDM) by Siemens.

HART Electronic Device Description (EDD)

Note: SITRANS Probe LR cannot be configured using a generic EDD.

In order to configure a HART device, the configurator must have the HART Electronic Device Description for the device in question. HART EDD's are controlled by the HART Communication Foundation.

Please contact your local Siemens representative concerning the availability of the HART EDD for SITRANS Probe LR. Older versions of the library will have to be updated in order to use all the features in the SITRANS Probe LR.

HART Communicator 275/375:

Chart 1

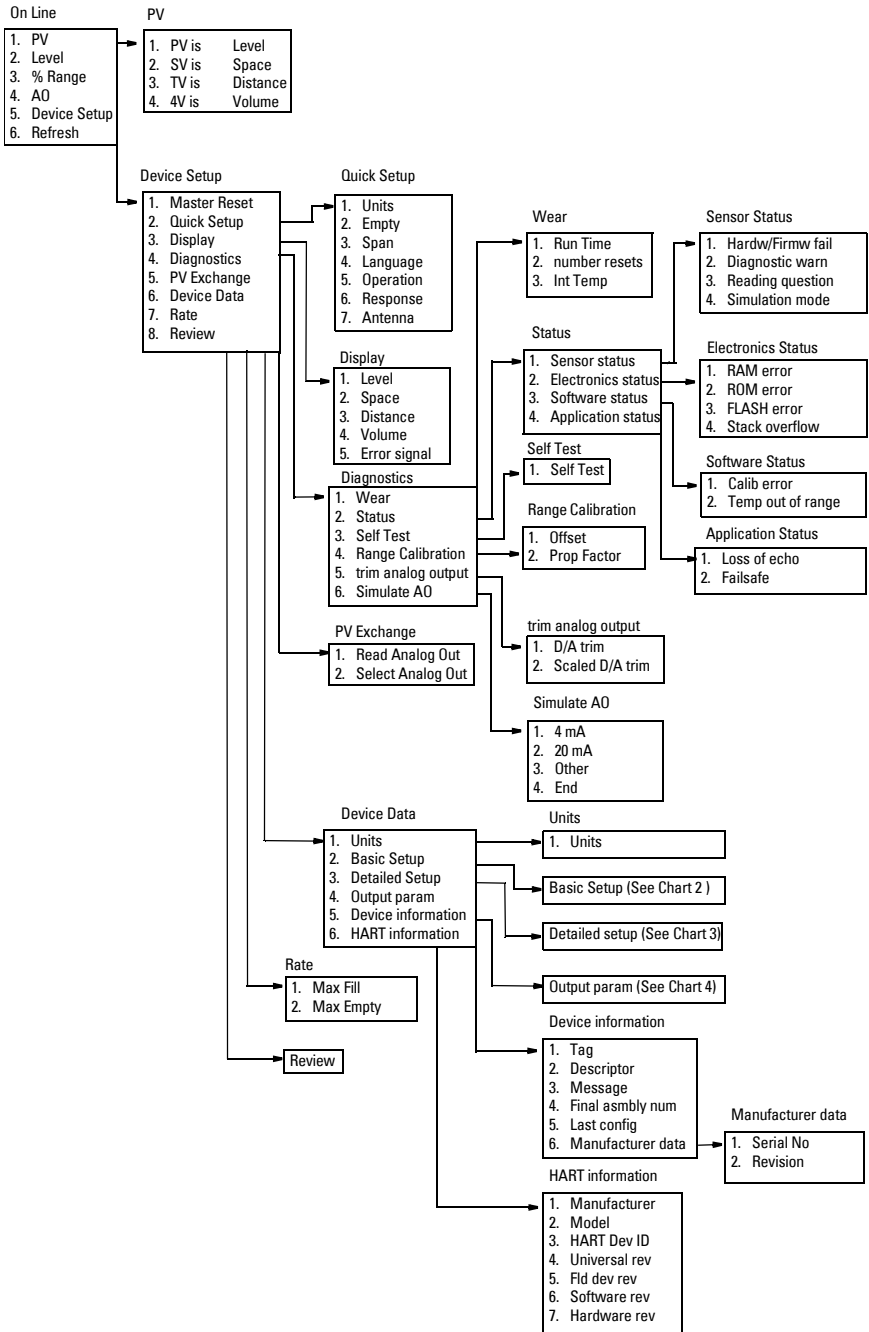

C: HART Communications

Chart 2

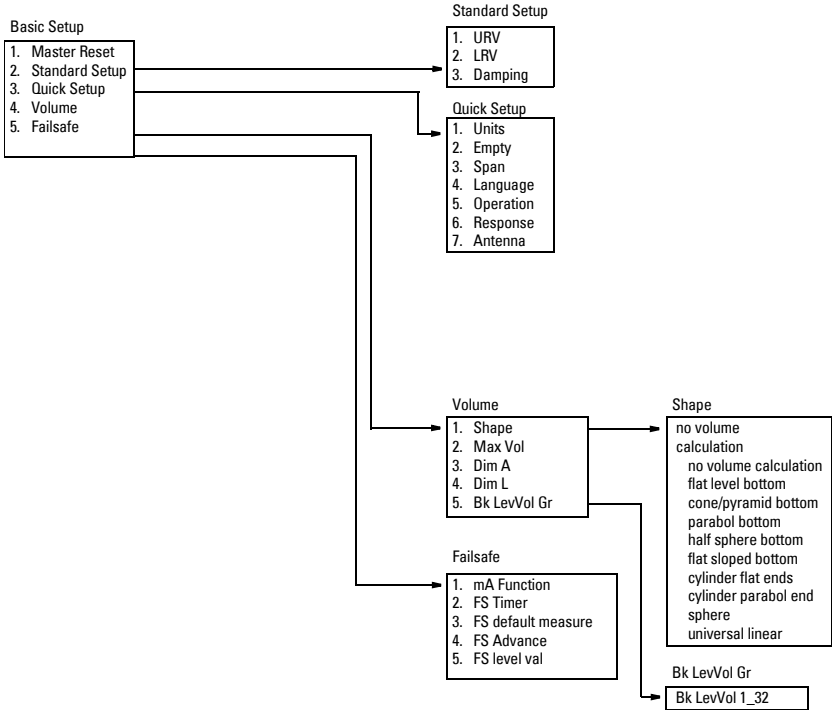

Chart 3

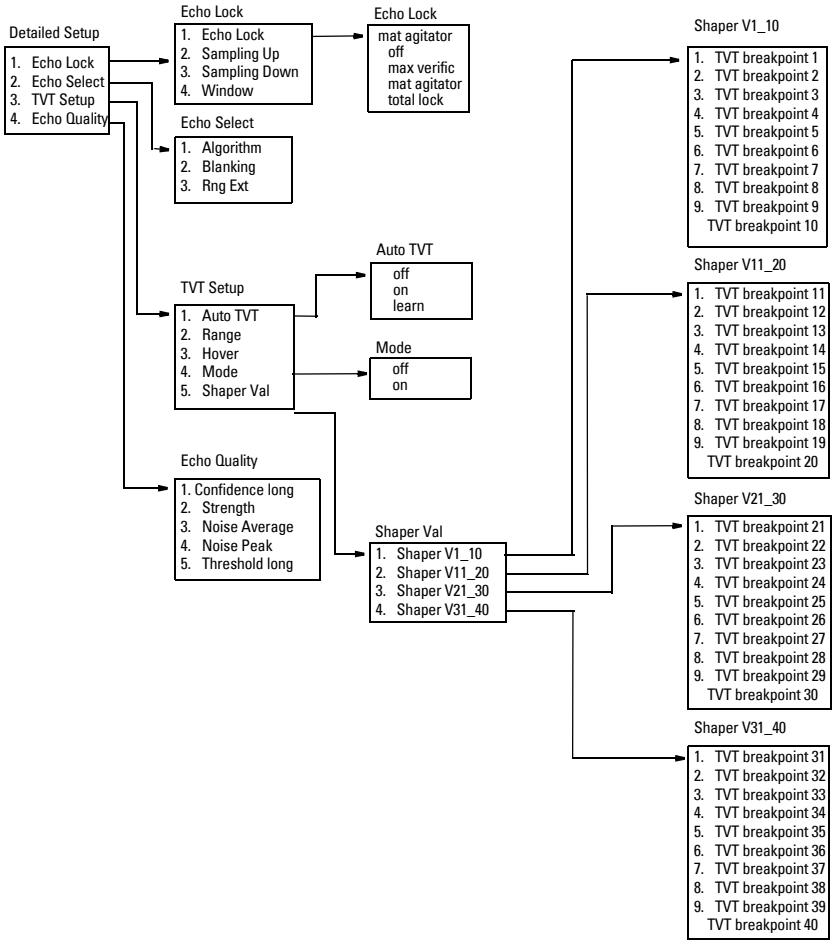
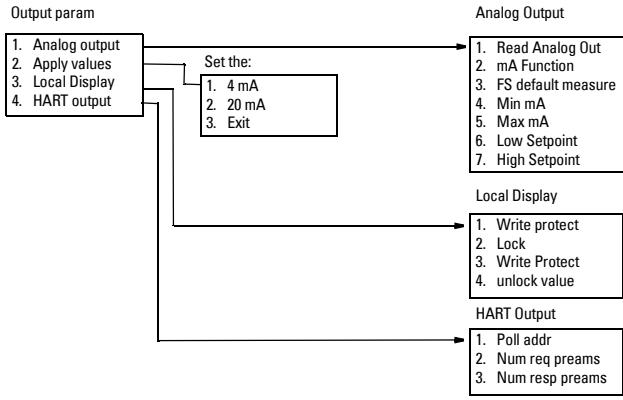

Chart 4



SIMATIC Process Device Manager (PDM)

This software package is designed to permit easy configuration, monitoring, and troubleshooting of HART devices. The HART EDD for SITRANS Probe LR was written with SIMATIC PDM in mind and has been extensively tested with this software.

The Device Description for SIMATIC PDM may be downloaded from the product page of our website at: <https://pia.khe.siemens.com/index.asp?Nr=11158>, under **Downloads**.

All parameters accessible via the HART Communicator are also accessible via PDM. In addition, the Maintenance parameters listed below are accessible via PDM only.

Maintenance settings (accessible via PDM only)

Device Lifetime

- Total Device Operating Time
- Remaining Device Lifetime
- Maintenance Required Limit
- Maintenance Demanded Limit
- Maintenance Alert Activation
- Total Expected Device Life
- Units
- Maintenance Status
- Acknowledge Status
- Acknowledge

Sensor Lifetime

- Total Sensor Operating Time
- Remaining Sensor Lifetime
- Maintenance Required Limit
- Maintenance Demanded Limit
- Maintenance Alert Activation
- Total Expected Sensor Life
- Units
- Maintenance Status
- Acknowledge Status
- Acknowledge

Service Interval

- Time Elapsed Since Last Service
- Maintenance Required Limit
- Maintenance Demanded Limit
- Maintenance Alert Activation
- Total Service Interval
- Units
- Maintenance Status
- Acknowledge Status
- Acknowledge

Calibration Interval

Time Elapsed Since Last Calibration
Maintenance Required Limit
Maintenance Demanded Limit
Maintenance Alert Activation
Total Calibration Interval
Units
Maintenance Status
Acknowledge Status
Acknowledge

HART Version

SITRANS Probe LR conforms to HART rev. 5.

Burst mode

SITRANS Probe LR does not support burst mode.

Appendix D: Troubleshooting

Communication Troubleshooting

Generally:

1. Check the following:
 - There is power at the instrument
 - The LCD shows the relevant data
 - The device can be programmed using the handheld programmer
2. Verify that the wiring connections are correct.
3. If you continue to experience problems, go to our website at: www.siemens.com/processautomation, and check the FAQs for SITRANS Probe LR, or contact your local Siemens representative.

Specifically:

1. If you try to set a SITRANS Probe LR parameter via remote communications, but the parameter remains unchanged:
 - Some parameters can only be changed when the device is not scanning. Try putting the device in PROGRAM mode using the operating mode function.
 - Try setting the parameter from the keypad. (First make sure that the lock parameter [P000] is set to the value stored in P069.)
 - The communications control parameter P799 must be set to **1** to allow you to write parameters to SITRANS Probe LR.

2. If you see unanticipated displays, for example:
 - PROGRAM mode displayed instead of RUN mode
 - the wrong parameter displayed in response to a command
 - a parameter displayed in response to no command

make sure no infrared-capable device is close to SITRANS Probe LR. Any device with infrared capabilities (laptops, cell phones, PDAs) can cause interference which simulates a command to the SITRANS Probe LR, potentially causing it to switch modes or to change a parameter.

3. If the operation is erratic, make sure the Handheld Programmer is not being used at the same time as SIMATIC PDM.

General Fault Codes

Note:

- The General Fault Codes were revised with Firmware Revisions 3.02. If your device has earlier firmware, see “Fault Codes (Firmware Revision 1.05 or earlier)” on page 85.
- Some faults cause the device to go to Failsafe mode (Fault 52). These are indicated with an asterisk (*).

Fault Codes (Firmware Revision 3.02 or higher)

Fault Codes (Firmware Revision 3.02 or higher)			
Code	Meaning	Corrective Action	
S:0	*	The device was unable to get a measurement within the Failsafe Timer period. Possible causes: faulty installation, antenna buildup, foaming/other adverse process conditions, invalid calibration range.	Ensure installation details are correct. Ensure no antenna buildup. Adjust process conditions to minimize foam or other adverse conditions. Correct range calibration. If fault persists, contact your local Siemens representative.
S:2	*	The device is operating in a low power condition that is outside its operating range. As a result, a valid measurement has not been taken for the failsafe timer period, and the device will be put into failsafe mode.	Correct the power supply (resistance or voltage).
S:3		Device is nearing its lifetime limit according to the value set in Maintenance Required Limit.	Replacement is recommended.
S:4		Device is nearing its lifetime limit according to the value set in Maintenance Demanded Limit.	Replacement is recommended.
S:6		Sensor is nearing its lifetime limit according to the value set in Maintenance Required Limit.	Replacement is recommended.
S:7		Sensor is nearing its lifetime limit according to the value set in Maintenance Demanded Limit.	Replacement is recommended.
S:8		Service interval as defined in Maintenance Required Limit has expired.	Perform service.
S:9		Service interval as defined in Maintenance Demanded Limit has expired.	Perform service.
S:11		Internal temperature sensor failure.	Repair required: contact your local Siemens representative.

Fault Codes (Firmware Revision 3.02 or higher) (Continued)		
Code	Meaning	Corrective Action
S:12	Internal temperature of device has exceeded specifications: it is operating outside its temperature range.	Relocate device and/or lower process temperature enough to cool device. Inspect for heat-related damage and contact your local Siemens representative if repair is required.
S:17	Calibration interval as defined in Maintenance Required Limit has expired.	Perform calibration.
S:18	Calibration interval as defined in Maintenance Demanded Limit has expired.	Perform calibration.
S:28	* Internal device failure caused by a RAM memory error.	Repair required: contact your local Siemens representative.
S:29	* EEPROM damaged.	Repair required: contact your local Siemens representative.
S:31	* Flash error.	Repair required: contact your local Siemens representative.
S:33	* Factory calibration for the internal temperature sensor has been lost.	Repair required: contact your local Siemens representative.
S:34	* Factory calibration for the device has been lost.	Repair required: contact your local Siemens representative.
S:35	* Factory calibration for the device has been lost.	Repair required: contact your local Siemens representative.
S:36	* Unable to start microwave module.	Reset power. If error persists, contact your local Siemens representative.
S:37	* Measurement hardware problem.	Reset power. If error persists, contact your local Siemens representative.

Fault Codes (Firmware Revision 3.02 or higher) (Continued)		
Code	Meaning	Corrective Action
S:38 *	Failure in the device electronics.	Reset power. If fault persists, contact your local Siemens representative: repair required.
S:43 *	Factory calibration for the radar receiver has been lost.	Repair required: contact your local Siemens representative.
S:44 *	Factory calibration for the echo slope has been lost.	Repair required: contact your local Siemens representative.
S:45 *	No valid boot program detected: firmware corrupt.	Repair required: contact your local Siemens representative.
S:48 *	User configuration is invalid. One or more of parameters: Span, Volume breakpoints, and/or Auto False-Echo Suppression, are set to invalid values.	Reconfigure the unit. Ensure Span (P007) is not set to 0; check the breakpoints (only required if P050 is set to 9); do a P999 reset.
S:49 *	EEPROM corrupt.	Repair required: contact your local Siemens representative.
S:50 *	EEPROM corrupt.	Repair required: contact your local Siemens representative.
S:51 *	EEPROM corrupt.	Repair required: contact your local Siemens representative.
S:52	Failsafe is activated. Possible causes: 1) hardware failure; 2) memory failure; 3) Fault 48; 4) failsafe timer expired– possible causes: faulty installation, antenna buildup, foaming/ other adverse process conditions, invalid calibration range.	For 3) and 4) Correct configuration; ensure installation is correct; no antenna buildup; adjust process conditions to minimize foaming/ other adverse conditions; correct calibration range. If fault persists, or for 1) and 2), contact your local Siemens representative.
S:53 *	Configuration lost: one or more parameter settings have been lost. This may occur after a firmware upgrade causes user parameters to be reset.	Restore user parameters using SIMATIC PDM.

Fault Codes (Firmware Revision 1.05 or earlier)

Note: Some faults cause the device to go to Failsafe mode (Fault 34). These are indicated with an asterisk (*).

Fault Codes (Firmware Revision 1.05 or earlier)			
Code	Meaning	Corrective Action	
13	*	User configuration has been lost. This may occur after a software upgrade causes user parameters to be reset.	Use PDM to restore the user parameters.
17		Standard device error category ^a .	None
18		Standard device error category ^a . This device has a single power supply: if it fails, the device is non-operational, and the fault will not be visible.	None
19	*	User configuration is invalid: device cannot operate. Parameters: Span, Volume breakpoints, and/or Auto False-Echo Suppression, are set to invalid values. Note: EEPROM Corrupted. If the parameter section of the EEPROM is corrupt, the device will not have a valid configuration, and will also show fault 39 and/or fault 40, and fault 34 (failsafe).	Check parameter settings for configuration errors, especially: Check Span is not set to 0. Check the breakpoints (only tested if P050 is set to 9). Do a P999 reset.
22		There is a maintenance issue on the device. Standard device error category ^a ; currently no maintenance faults are activated.	None
23		Standard device error category ^a , not supported.	None
25		The following problem has occurred in the electronics of the device: DMA failure	Cycle the power: this may temporarily solve the problem. Do not use the device for measurement, but return it to the factory as soon as possible.
26	*	A mechanical failure in the device, such as a broken cable.	None
27		Standard device error category ^a .	None

Fault Codes (Firmware Revision 1.05 or earlier) (Continued)





Code	Meaning	Corrective Action	
28	Internal temperature of the device has been exceeded: it is operating outside its temperature range.	Lower the ambient temperature enough to cool the device.	
29	During a memory check, a problem with the memory has occurred. Explanation: The device periodically validates RAM, Flash, and EEPROM memory. If any fault is found, Fault 29 is displayed. Potential causes are: normal wear and tear operating outside temperature range other electrical damage	Replace unit.	
30	*	The device was unable to get a measurement for the failsafe timer period.	Check the application and echo profile, to determine optimum configuration for the application, to ensure the device can obtain a measurement.
31	*	The device has failed to initialize itself properly.	Reset the device. If the problem persists, check for the presence of another fault and take corrective action on this fault. If the problem persists, call the factory.
32	*	The device is not calibrated. All devices must be fully calibrated in the factory.	Return device to factory.
34		Failsafe is activated. The output current is set to the failsafe behavior. The reason for the failsafe will be indicated by the presence of at least one other fault.	Determine the other fault (alternating on the display, or in the diagnosis/status word in communication master) and take corrective action on that fault.
35		Internal device failure caused by a memory error.	The fault should never appear. If it does, the device should reset itself and there is no action to be taken, It should be reported to the factory.

Fault Codes (Firmware Revision 1.05 or earlier) (Continued)		
Code	Meaning	Corrective Action
38	* The internal EEPROM has become corrupted ^b , or was not configured properly at the factory.	Replace product
39	* The internal EEPROM has become corrupted ^c , or was not configured properly at the factory.	Replace product
40	* The internal EEPROM has become corrupted ^b , or was not configured properly at the factory.	Replace product
41	* The internal EEPROM has become corrupted ^b , or was not configured properly at the factory.	Replace product
42	* The device is operating in a low power condition that is outside its operating range. As a result, a valid measurement has not been taken for the failsafe timer period, and the device will be put into failsafe mode.	Correct the power supply (resistance or voltage).

- a. The error will never occur on this device, but is included to complete the list and match industry standards.
- b. EEPROM can become corrupted due to operating the device outside its operating range (power and temperature), or other damage.
- c. EEPROM can become corrupted due to operating the device outside its operating range (power and temperature), or other damage.

Operation Troubleshooting

Operating symptoms, probable causes, and resolutions.

Symptom	Cause	Action
Display flashes LOE and status symbol shows 	level or target is out of range	<ul style="list-style-type: none"> • check specifications • check P006 • increase range extension P805
Display flashes LOE and status symbol shows 	material build-up on antenna	<ul style="list-style-type: none"> • clean the antenna • re-locate SITRANS Probe LR
Display flashes LOE and status symbol shows 	location or aiming: <ul style="list-style-type: none"> • poor installation • flange not level 	<ul style="list-style-type: none"> • check to ensure nozzle is vertical • use P837/P838 • check to ensure nozzle is clean and free of internal seams/welds
Display flashes LOE and status symbol shows 	antenna malfunction: <ul style="list-style-type: none"> • temperature too high • physical damage • excessive foam • multiple echoes 	<ul style="list-style-type: none"> • check P343 • use foam deflector or stilling well • relocate • use a defoamer • set P820 to 12 (First echo)

Symptom	Cause	Action
Reading does not change, but the level does	SITRANS Probe LR processing wrong echo, i.e. vessel wall, or structural member	<ul style="list-style-type: none"> re-locate SITRANS Probe LR check nozzle for internal burrs or welds rotate instrument 90° use P837/P838
Level reading on Display is correct but Loop is stuck on 4 mA	Basic configuration data is questionable	<ul style="list-style-type: none"> set POLL ADR to 0 if not using HART multi-drop
Measurement is consistently off by a constant amount	P006 not correct P652 not correct	<ul style="list-style-type: none"> check distance from reference point to zero level (P006) check offset value (P652)
Screen blank	power error	<ul style="list-style-type: none"> check nameplate rating against voltage supply check power wiring or source
	too much load resistance	<ul style="list-style-type: none"> change barrier type, or remove something from the loop, or increase supply voltage
Reading erratic	echo confidence weak	<ul style="list-style-type: none"> refer to P805 use P837/P838 use foam deflector or stilling well
	liquid surface vortexed	<ul style="list-style-type: none"> decrease measurement response P003 relocate instrument to side pipe increase confidence threshold P804
	material filling	<ul style="list-style-type: none"> re-locate SITRANS Probe LR
Reading response slow	P003 setting	<ul style="list-style-type: none"> increase measurement response if possible

Symptom	Cause	Action
Reads correctly but occasionally reads high when vessel is not full	<ul style="list-style-type: none"> detecting close range echo build up near top of vessel or nozzle wrong antenna choice for application vessel nozzle problem 	<ul style="list-style-type: none"> clean the antenna longer shield required see <i>Application Example: Stilling-well</i> on page 98 use P837/P838
Level reading lower than material level	<ul style="list-style-type: none"> material is within near blanking zone vessel near empty and low ϵ_r material multiple echoes processed 	<ul style="list-style-type: none"> decrease blanking P800: min. 0.3 m (1 ft) plus the shield length (if any) raise SITRANS Probe LR decrease range extension ensure P820 is set to 12 (First echo)
	<ul style="list-style-type: none"> nozzle too narrow for length 	<ul style="list-style-type: none"> shielded antenna required: discuss with your Siemens representative.
	<ul style="list-style-type: none"> internal seam in nozzle 	<ul style="list-style-type: none"> inspect and remove seam use P837/P838 longer shield required

Maintenance

SITRANS Probe LR requires no maintenance or cleaning under normal operating conditions.

Under severe operating conditions, the antenna may require periodic cleaning. If cleaning becomes necessary:

- Note the antenna material and the process medium, and select a cleaning solution that will not react adversely with either.
- Remove the instrument from service and wipe the antenna clean using a cloth and suitable cleaning solution.

Unit Repair and Excluded Liability

All changes and repairs must be done by qualified personnel, and applicable safety regulations must be followed. Please note the following:

- The user is responsible for all changes and repairs made to the device.
- All new components must be provided by Siemens Milltronics Process Instruments Inc.
- Restrict repair to faulty components only.
- Do not re-use faulty components.

Appendix E: Technical Reference

Principles of Operation

SITRANS Probe LR is a sophisticated radar instrument that uses advanced microwave pulse technology¹ to provide non-contacting continuous level measurement in liquids or slurries. Radar level measurement uses the time of flight principle to determine distance to a material surface. The device transmits a signal and waits for the return echo. The transmit time is directly proportional to the distance from the material.

Pulse radar uses polarized electromagnetic waves. Microwave pulses are emitted from the antenna at a fixed repetition rate, and reflect off the interface between two materials with different dielectric constants (the atmosphere and the material being monitored). The echo is detected by a receiver, and the transmit time is used to calculate level.

Electromagnetic wave propagation is virtually unaffected by temperature or pressure changes, or by changes in the vapor levels inside a vessel. Electromagnetic waves are not attenuated by dust.

SITRANS Probe LR consists of an enclosed electronic component coupled to an antenna and process connection. The electronic component generates a radar signal (6.3 GHz in North America, 5.8 GHz elsewhere) that is directed to the antenna.

The signal is emitted from the antenna, and the reflected echoes are digitally converted to an echo profile. The profile is analyzed to determine the distance from the material surface to the reference point on the instrument. This distance is used as a basis for the display of material level and mA output.

Transceiver

The SITRANS Probe LR transceiver operates under one of three sets of pre-set conditions which affect the speed of the measurement response (P003).

Measurement Response P003		Max. fill/empty rate P700/P701		Echo verification P711	Failsafe timer P070 (time in minutes)
1	*	0.1 m/min	slow	2	100
2		1 m/min	medium	2	10
3		10 m/min	fast	2	1

¹ The microwave output level is significantly less than that emitted from cellular phones.

The measurement response limits the maximum rate at which the display and analog output respond to changes in measurement. P003 should be set to a measurement response just faster than the maximum filling or emptying rate (whichever is greater).

When the echoes are received, the relevant echo algorithm (P820) is applied to determine the true material echo.

Typical Receiver Signal

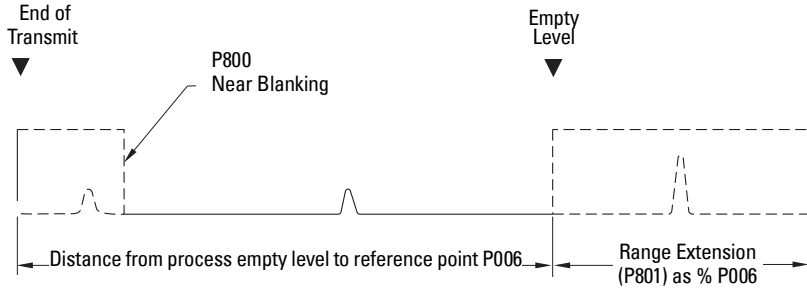

Near Blanking

Near Blanking¹ programs SITRANS Probe LR to ignore the zone in front of the antenna. The default blanking distance is 0.3 m (1 ft) plus any shield length, from the reference point².

P800 allows you to increase the near blanking value from its factory setting. But Auto False-Echo Suppression (P837) is generally recommended in preference to extending the blanking distance from factory values.

Loss of Echo (LOE)

A loss of echo (LOE) occurs when the calculated measurement is judged to be unreliable because the confidence value (P805) is less than the threshold value (P804).

If the LOE condition persists beyond the time limit set by the Failsafe timer (P070), the Reliable Echo indicator will be replaced by the Unreliable Echo indicator. The reading will alternate at two second intervals with the letters LOE.

Reliable Echo indicator  Unreliable Echo indicator 

P070 determines the time to elapse after the last valid reading before a Failsafe state is activated. P071 determines the level to be reported when the Failsafe timer expires. Upon receiving a reliable echo, the loss of echo condition is aborted, the Reliable Echo indicator replaces the Unreliable Echo indicator, and the reading and mA output return to the current level.

¹ Also referred to as "Blanking".

² For the reference point, see *SITRANS Probe LR: Dimensions* on page 15.

Range Extension

In applications where the base of the vessel is conical or parabolic, a reliable echo may be available **below** the vessel empty distance, due to an indirect reflection path. Increasing the range extension to 30% or 40% can provide stable empty vessel readings.

Range extension is entered as a percentage of P006 (process empty level).

False-Echo Suppression

False echoes can appear during the receive cycle. They are often created by internal impediments like a ladder rung, and are usually indicated by an incorrect high level reading.

TVT (Time Varying Threshold) curves

A TVT curve defines a threshold below which any echoes will be ignored. The default TVT curve hovers above the echo profile, and effectively screens out small false echoes. But if an obstruction is causing a large echo before the material level echo, that echo will rise above the default TVT curve. You can use Auto False-Echo Suppression to filter it out.

The default TVT curve is used until P837 and P838 are used to create a new "learned TVT curve".

Auto False-Echo Suppression

The TVT adjustment parameters allow you to adjust the TVT (Time Varying Threshold) curve, so that SITRANS Probe LR will ignore false echoes in your application.

P838 allows you to set a distance, and P837 then instructs SITRANS Probe LR to "learn" where the obstructions/false echoes are within that distance. If possible, rotate the instrument before using Auto False-Echo Suppression, to lower the amplitude of false echoes.

When you set P837 to "Learn", the instrument learns the echo profile at that moment¹. Then it uses the learned profile instead of the default TVT curve, for the distance set in P838. The learned profile (learned TVT curve) follows the echo profile, so that no large false echoes rise above the learned TVT curve. From the end of the Auto False-Echo Suppression Distance, the default TVT curve is used. The material level echo rises above this, and is selected as the true echo.

See page 95 for examples of the echo profile before and after using Auto False-Echo Suppression.

¹ Set P837 to "Learn" when the material level is substantially lower than process full level (ideally when the tank is empty or almost empty).

Display before Auto False-Echo Suppression (or when P837 = 0)

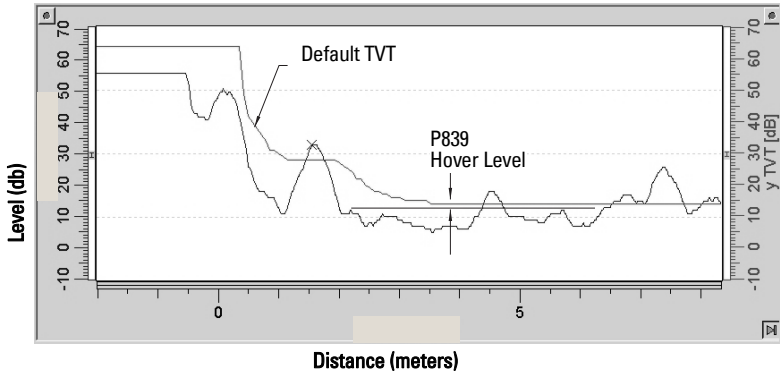

Example After Auto False-Echo Suppression

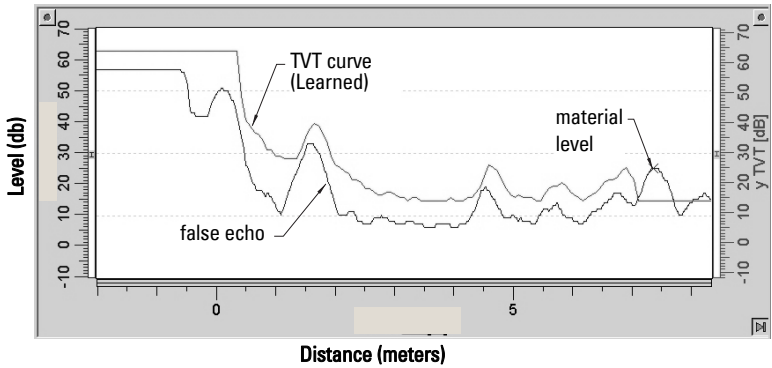

RUN/PROGRAM

Output

The mA output is proportional to the level, in the range 4 to 20 mA. Generally, the output is set so that the output for 0% is 4 mA, and the output for 100% is 20 mA. 0 and 100% are percentages of the full-scale reading (m, cm, mm, ft, in).

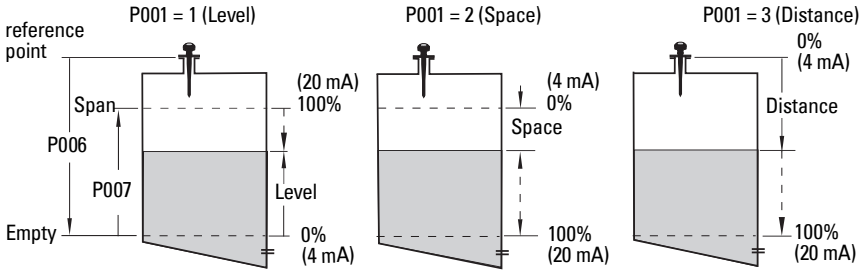

When SITRANS Probe LR is put into **PROGRAM** mode it stops responding to the process. It stores the most recent measurement, and holds the associated readings and mA signal output. The instrument reverts to the parameter last addressed during the previous program session.

When the instrument is returned to **RUN** mode, the transceiver resumes operation. The reading and mA output default to the last measurement taken. The reading and associated outputs migrate to the current process level at a rate controlled by the measurement response (P003).

If SITRANS Probe LR is left in **PROGRAM** mode for 10 minutes without input, it automatically reverts to **RUN** mode.

Failsafe

The Failsafe function can be activated either if there is not a valid measurement, or by one of the faults marked by an asterisk in the table *General Fault Codes* on page 82. In Failsafe mode, the device will output one of the four options determined by P071 (Failsafe Material Level).

Failsafe Mode P071	
1 = HI	Use Maximum mA Limit (P213) as material level
2 = LO	Use Minimum mA Limit (P212) as material level
3 = HOLd	Level remains at last reading
4 = SEL	User-selected value (defined in P073)

If an invalid measurement is generated by the application (for example, material level outside threshold settings), the Failsafe timer (P070) will control the speed of the Failsafe response. When the Failsafe timer expires, the device outputs the value selected in P071. If a valid measurement is received before the timer expires, the timer will be reset.

If Failsafe mode is activated by a fault (see *General Fault Codes* on page 82), the instrument will go into Failsafe mode without delay.

Chemical compatibility

The plastic materials used in the construction of SITRANS Probe LR (polypropylene, PBT¹, and PEI²) are resistant to attack from most chemicals. For exposure to specific environments, check with chemical compatibility charts before installing and operating SITRANS Probe LR in your application.

1. Polybutylene terephthalate
2. Polyether Imide

Appendix F: Special Applications

This more complex SITRANS Probe LR application example can be used as a setup reference. The parameter value tables relate the values to the functions.

Application Example: Stilling-well

This is typically recommended for products with an ϵ_r of less than 3, or if extremely turbulent or vortex conditions exist. This mounting arrangement can also be used to provide optimum signal conditions on foaming materials.

Notes:

- For $\epsilon_r < 3$, the lower 400 mm of vessel level may not be measurable.
- Suitable pipe diameters are 50 mm (2") to 250 mm (10"). See the chart on page 99 for typical P655 values.

This application is to obtain a level measurement and corresponding 4-20 mA output proportional to the oil level in a fuel storage vessel.

- The reference point of SITRANS Probe LR is 5 m (16.5 ft) from the vessel bottom.
- Empty level is 0 m/ft (bottom of tank).
- Full level (span) is 4.5 m (14.74 ft) from the bottom.
- The stilling-well inside diameter is 100 mm (4").
- The maximum rate of filling or emptying is about 0.1 m (4")/min.
- In the event of a loss of echo, SITRANS Probe LR is to go into Failsafe Hi after 2 minutes.

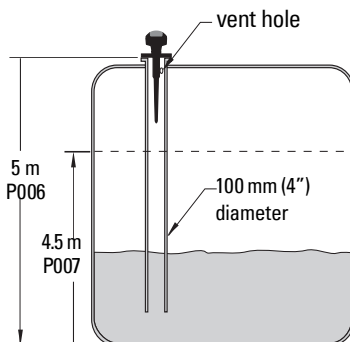

Parameter	Enter		
P001	1	mode of measurement	= level
P003	2	measurement response	= 1 m/minute
P005	1	units	= meters
P006	5	empty distance	= 5 m
P007	4.5	span	= 4.5 m
P655*	0.955	propagation factor	= 10 mm pipe I.D.
P838 ^a	distance to material – 0.5 m	auto false-echo suppression distance	
P837 ^{a, b}	2	auto false-echo suppression	enable false-echo suppression

- a. For more details on P837 and P838, see page 64.
- b. Only set P837 if the product is at least 2 m (78") away from the flange face. If it is closer, leave P837 at 1 until the level drops and the distance increases beyond 2 m (78").

Return to RUN: press **PROGRAM**  to return to normal operation.

Pipe Inside Diameter	P655 Value (Typical)*
50 mm (2")	0.827
80 mm (3")	0.915
100 mm (4")	0.955
150 mm (6")	0.980
200 mm (8")	0.990

* These values are provided as a guideline only.

Appendix G: hazardous area installations

- Wiring details
- Instructions specific to hazardous area installations

Wiring Details

Intrinsically Safe Model

FM (reference drawing 23651611)

CSA (reference drawing 23651621)

Under the entity evaluation concept, SITRANS Probe LR has the following characteristics:

(input voltage) U_i	= 30 V DC (max.)
(input current) I_i	= 120 mA DC (max.)
(internal capacitance) C_i	= 3.6 nF
(internal inductance) L_i	= 0.1 mH

Definition:

The Entity Concept allows interconnection of intrinsically safe apparatus to associated apparatus not specifically examined in such combination. The criteria for interconnection is that the voltage and current which intrinsically safe apparatus can receive and remain intrinsically safe, considering faults, must be equal to or greater than the output voltage (U_o) and output current (I_o) levels which can be delivered by the associated apparatus, considering faults and applicable factors. In addition, the maximum unprotected capacitance (C_i) and Inductance (L_i) of the intrinsically safe apparatus, including interconnecting wiring, must be equal to or less than the capacitance and inductance which can be safely connected to associated apparatus.

FM/CSA

- Approved dust-tight and water-tight conduit seals are required for outdoor NEMA 4X / type 4X / NEMA 6, IP67, IP68 locations.
- The maximum voltage of the non-intrinsically safe apparatus must not exceed 250 V rms.
- Recommended intrinsically safe barriers are listed on page 102.

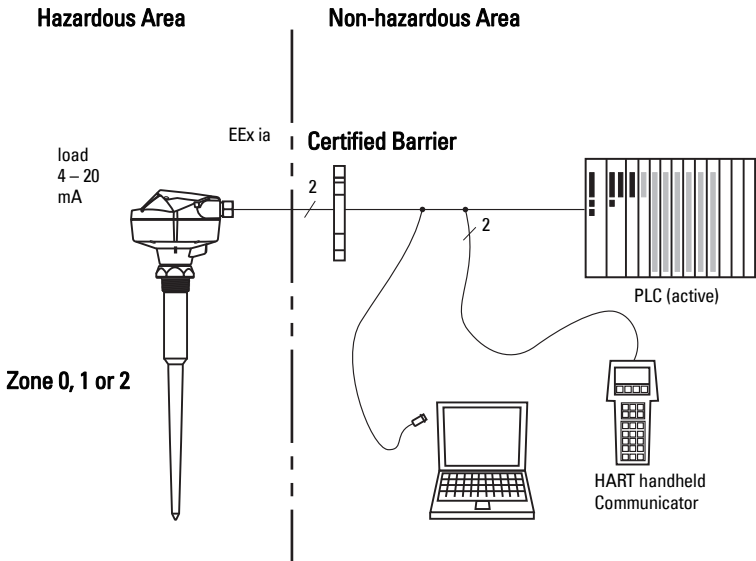

EU Equivalency

Any zener diode safety barrier, certified by an EU approved certification body to [EEx ia] IIC, its output voltage (U_o) not exceeding 30 V and its output current (I_o) limited by load resistance (R_o); such that $I_o = U_o / R_o$, does not exceed 120 mA.

Notes

- The electrical circuit in the hazardous area must be capable of withstanding an AC test voltage of 500 V rms to earth or frame of the apparatus for one minute.
- The installation must comply with national requirements.
- The safe area is unspecified except that it must not be supplied from nor contain, under normal or abnormal conditions, a source of potential with respect to earth in excess of 250 V rms or 250 V DC.

Loop Voltage versus Loop Resistance

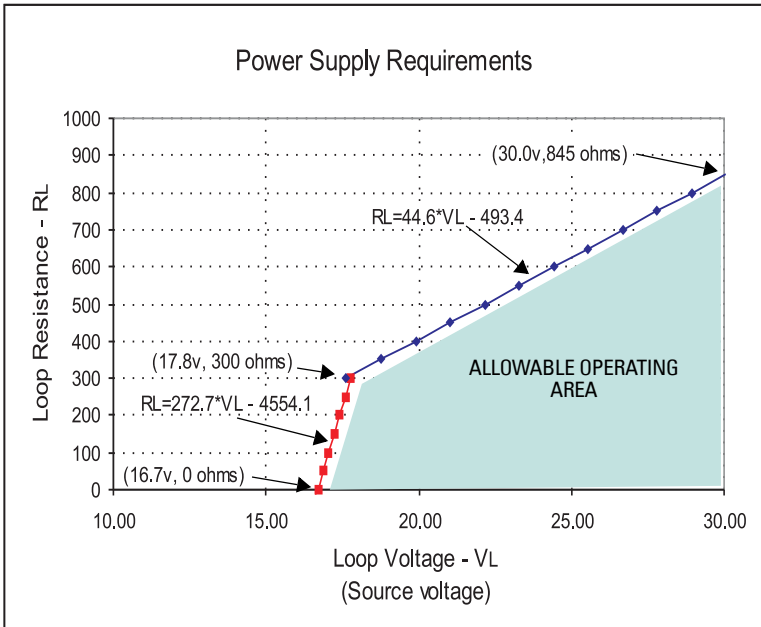

IS Safety Barrier Selection

Selecting a suitable barrier or power supply requires knowledge about Intrinsic Safety and the application. It is the responsibility of the installer to ensure that the intrinsically safe installation complies with both the apparatus approval requirements and the relevant national code of practice.

How to select a passive barrier for SITRANS Probe LR

1. Make sure that the barrier safety description is suitable for the SITRANS Probe LR Intrinsically Safe (IS) input parameters.
2. Determine the maximum end-to-end resistance of the barrier (R_{e-e}) from the data sheet.
3. Determine other loop resistance (R_{loop}): for example, sense resistance, displays, and/or PLC inputs.
4. Calculate $R_{working} = R_{e-e} + R_{loop}$.

5. Determine any non-linear voltage drops due to the barrier (V_{barrier}) from the barrier data sheet (for example, voltage drops due to diodes).
6. Calculate $V_{\text{working}} = V_{\text{supply}} - V_{\text{barrier}}$.
7. Using V_{working} and R_{working} , confirm that operation is within the shaded area of the graph *Loop Voltage versus Loop Resistance* on page 102.

Notes:

- The following list is not complete: there are many safety barriers on the market, which will work with the SITRANS Probe LR.
- The barriers listed below have all been tested and are functionally compatible with the SITRANS Probe LR.
- The barriers listed below are all HART compatible.

PLC Input Modules

Manufacturer	Part Number
Siemens	SM331 PCS7 HART Input Module

Passive Shunt Diode Barriers

Note: A well regulated supply voltage is required.

Manufacturer	Part Number
MTL	787SP+ (Dual channel)
MTL	7787P+ (Dual channel)
Stahl	9001/01-280-100-10 (Single channel)
Stahl	9002/01-280-110-10 (Dual channel)

Active barriers (repeating barriers)

Manufacturer	Part Number
MTL	706
MTL	7206
Stahl	9001/51-280-110-14

Instructions specific to hazardous area installations

(Reference European ATEX Directive 94/9/EC,

Annex II, 1/0/6)

The following instructions apply to equipment covered by certificate number SIRA 03ATEX2142X:

1. For use and assembly, refer to the main instructions.
2. The equipment is certified for use as Category 1G equipment.
3. The equipment may be used with flammable gases and vapors with apparatus group IIC and temperature class T4.
4. The equipment is certified for use in an ambient temperature range of $-40\text{ }^{\circ}\text{C}$ to $80\text{ }^{\circ}\text{C}$.
5. The equipment has not been assessed as a safety related device (as referred to by Directive 94/9/EC Annex II, clause 1.5).
6. Installation and inspection of this equipment shall be carried out by suitably trained personnel in accordance with the applicable code of practice (EN 60079-14 and EN 60079-17 in Europe).
7. Repair of this equipment shall be carried out by suitably trained personnel in accordance with the applicable code of practice (e.g. EN 60079-19 within Europe).
8. Components to be incorporated into or used as replacements in the equipment shall be fitted by suitably trained personnel in accordance with the manufacturer's documentation.
9. It is the responsibility of the user to ensure that manual override is possible in order to shut down the equipment and protective systems incorporated within automatic processes which deviate from the intended operating conditions, provided that this does not compromise safety.
10. The "X" suffix to the certificate number relates to the following special conditions for safe use:
 - a. Parts of the enclosure may be non-conducting and may generate an ignition-capable level of electrostatic charge under certain extreme conditions. The user should ensure that the equipment is not installed in a location where it may be subjected to external conditions (such as high-pressure steam) which might cause a build-up of electrostatic charge on non-conducting surfaces.
11. If the equipment is likely to come into contact with aggressive substances, then it is the responsibility of the user to take suitable precautions that prevent it from being adversely affected, thus ensuring that the type of protection is not compromised.

Aggressive substances: e.g. acidic liquids or gases that may attack metals, or solvents that may affect polymeric materials.

Suitable precautions: e.g. regular checks as part of routine inspections or establishing from the material's data sheet that it is resistant to specific chemicals.

12. Equipment Marking

The equipment marking contains at least the information on the product nameplate, shown on page 105.

Product Nameplate

SIEMENS			
_____ 7ML1234-56789-0ABC-D Serial No. GYZ/S1034567 Encl.: NEMA / TYPE 4X, 6, IP67, IP68 Amb. Temp.: -40 °C to 80 °C Power Rating: 24V --- Nom., 30V --- Max., 4-20mA _____ Siemens Milltronics Process Instruments Inc., Peterborough _____ Made in Canada		_____ CANADA: 267P- _____ Per drawing: 23651611 Class I, Div 1, Group A, B, C, D Class II, Div 1, Group E, F, G Class III Temp. Code: T4 HART _____ WARNING: POSSIBLE STATIC HAZARD, DO NOT RUB OR CLEAN ON SITE.	
_____ FCC ID: NJA-LR200 II 1G EEx'ia IIC T4 03ATEX2142X SIRA CE 0682 0518 Ex'ia IIC T4 N117 IECEx TSA 04.0020X		_____ II=120mA, UI=30V, LI=0.1mH, PI=0.8W, CI=3.6nF ANZEx 04.3016X Ex'ia IIC T4	

G: Hazardous installation

Intrinsically safe connection drawing (FM)

Drawing number 23651611

G: Hazardous installation

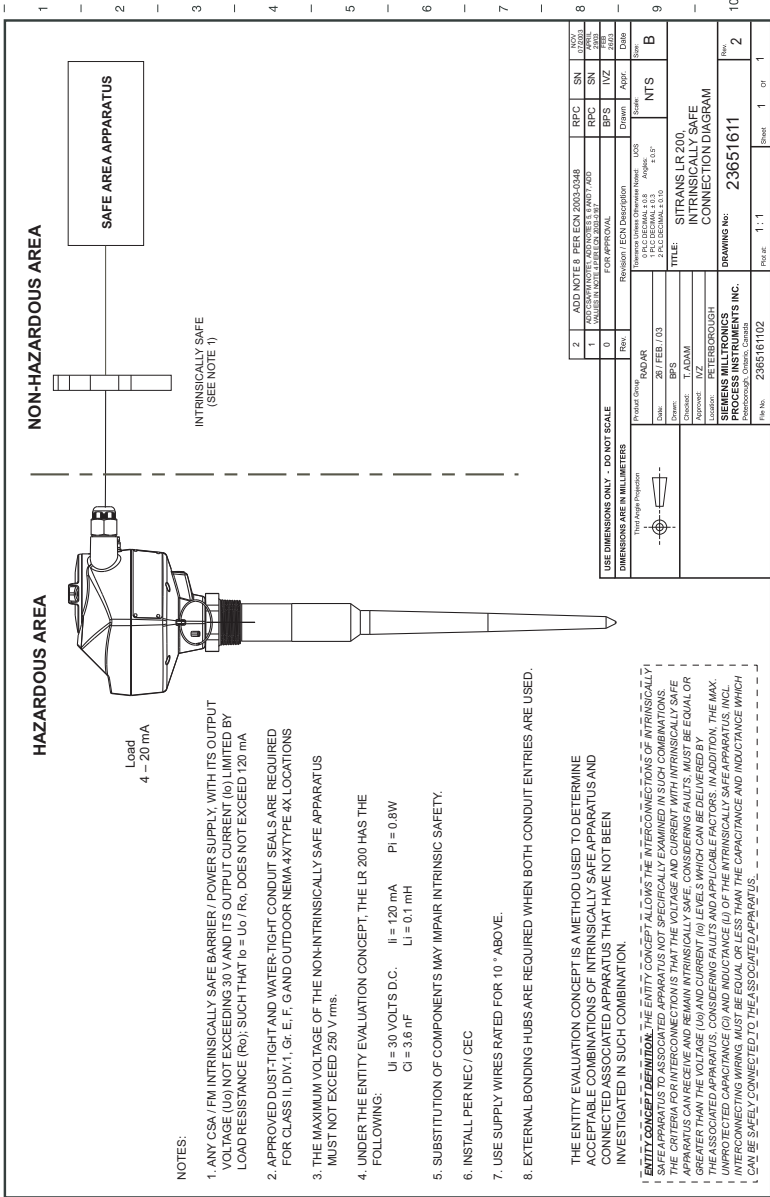

Intrinsically safe connection drawing (CSA)

Drawing number 23651621

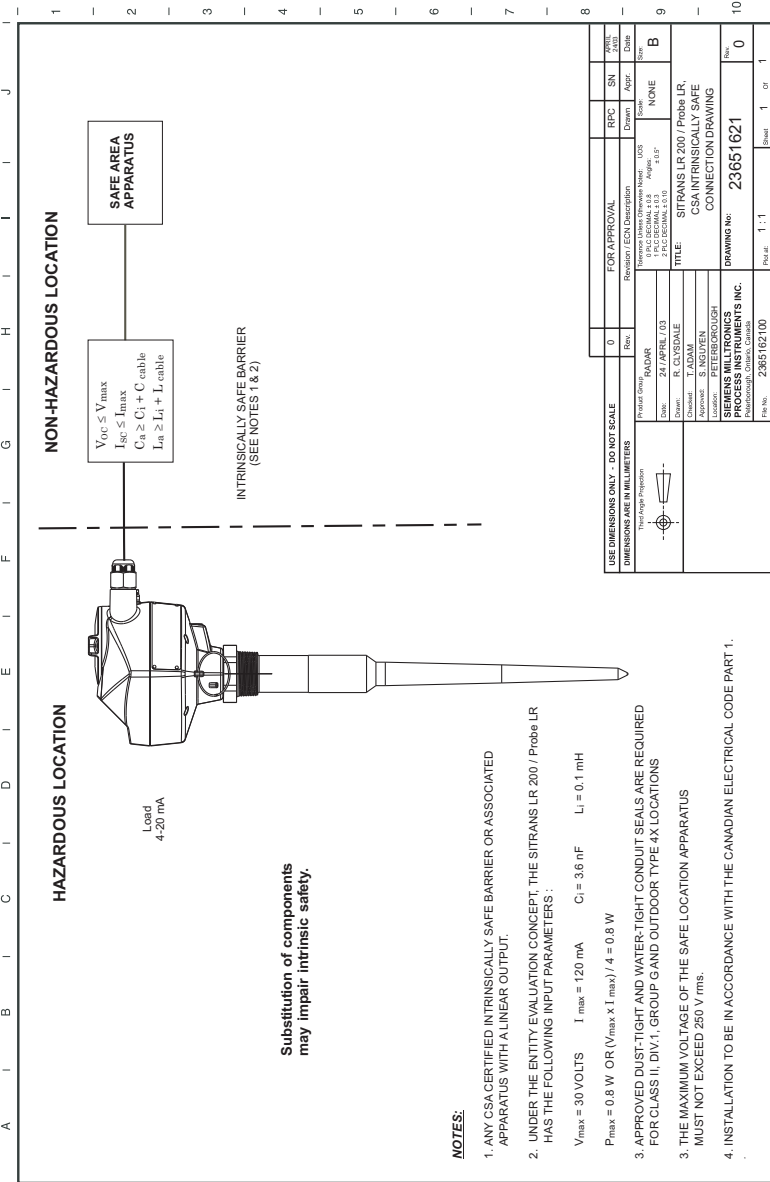

USE DIMENSIONS ONLY - DO NOT SCALE		FOR APPROVAL		APRIL 2010	
DIMENSIONS ARE IN MILLIMETERS		Revision / ECU Description	RPC	SN	Drawn
Third-angle projection		Reference Class / Revision No.	Drawn	Appr.	Size
Part No.	PROBE LR	9-PCS SERIAL 10.3	NONE	NONE	B
Date	21 APRIL 2010	9-PCS SERIAL 10.3	Scale		
Drawn	T. ADAM	9-PCS SERIAL 10.3	None		
Checked	T. ADAM	9-PCS SERIAL 10.3			
Approved	S. NGUYEN	TITLE: SITRANS LR 200 / Probe LR, CSA INTRINSICALLY SAFE CONNECTION DRAWING			
Location	PETERBOROUGH	DRAWING No: 23651621			
Company	PROCES INDUSTRIES INC.	Rev: 0			
Plant	Peterborough, Ontario, Canada	Part No. 2365162100			
File No.	2365162100	Part: 1 : 1 Sheet 1 of 1			

G: Hazardous installation

Non-incendive connection drawing (FM)

Drawing number 23650537

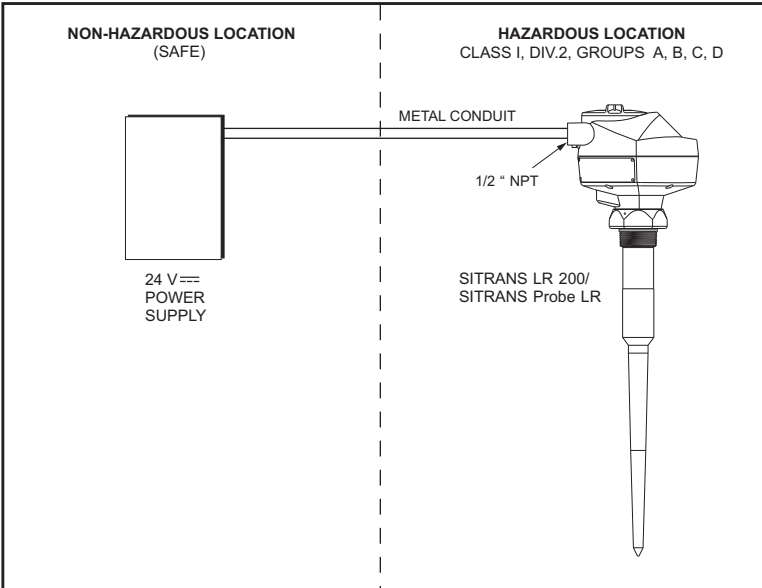

NOTES:

- 1) INSTALLATION SHALL BE DONE IN ACCORDANCE WITH THE NATIONAL ELECTRICAL CODE.
- 2) USE APPROVED WATER TIGHT CONDUIT FITTINGS FOR OUTDOOR APPLICATIONS.
- 3) FOR FURTHER INFORMATION REFER TO THE SITRANS LR 200 / Probe LR INSTRUCTION MANUAL

	1	REMOVE NON- FROM HAZARDOUS SIDE PER ECN 2004-0113	RPC	SN	MAY 03/2004
USE DIMENSIONS ONLY - DO NOT SCALE	0	FOR CONSTRUCTION	RPC	SN	MAR 02/2004
DIMENSIONS ARE IN INCHES	Rev.	Revision / ECN Description	Drawn	Appr.	Date
Third Angle Projection 	Product Group	Tolerance Unless Otherwise Noted: UGS 1 Place Decimal ± 0.03 2 Place Decimal ± 0.01 3 Place Decimal ± 0.002	Scale:	Size:	
	RADAR	Angles: ± 0.5°	NTS	A	
	Date: 05 / MAR / 2004	TITLE: SITRANS LR 200 / PROBE LR CLASS I, Div. 2 CONNECTION DRAWING			
	Drawn: R. CLYSDALE	DRAWING No: 23650537			
	Checked: T. LITTLE	Rev. 1			
	Approved: S. NGUYEN				
	Location: PETERBOROUGH				
	SIEMENS MILLTRONICS PROCESS INSTRUMENTS INC. Peterborough, Ontario, Canada				
	File No. 2365053701	Plot at: 1 : 1	Sheet 1	Of 1	

G: Hazardous installation

Appendix H: Firmware Revision History

Firmware Rev.	EDD Rev.	Date	Changes
1.04	2.00	15 Jun 2004	<ul style="list-style-type: none"> Original Software Release.
1.05		10 Aug 2004	<ul style="list-style-type: none"> Corrected issue: P210 and P211 values (or HART values for URV/LRV) were not being preserved over a power cycle if operation was set to distance or volume.
3.02	3.02.01	27 Feb 2006	<ul style="list-style-type: none"> Resolved issue that could cause peak to be selected below the TVT curve. MP&F parameters added to device. Fault system upgraded to use S# codes to match PROFIBUS products. Increased number of level/volume breakpoints to 32. Improved linearity over ambient temperature. <p>NOTE: Software revision 3.02 is not backwards compatible due to hardware compatibility.</p>

Notes:

Glossary

accuracy: degree of conformity of a measure to a standard or a true value.

agitator: mechanical apparatus for mixing or aerating. A device for creating turbulence.

algorithm: a prescribed set of well-defined rules or processes for the solution of a problem in a finite number of steps.

ambient temperature: the temperature of the surrounding air that comes in contact with the enclosure of the device.

antenna: an aerial which sends out and receives a signal in a specific direction. There are four basic types of antenna in radar level measurement, horn, parabolic, rod, and waveguide.

attenuation: a term used to denote a decrease in signal magnitude in transmission from one point to another. Attenuation may be expressed as a scalar ratio of the input magnitude to the output magnitude or in decibels.

Auto False-Echo Suppression: a technique used to adjust the level of a TVT curve to avoid the reading of false echoes. (See TVT.)

Auto False-Echo Suppression Distance: defines the endpoint of the TVT distance. (See TVT.) This is used in conjunction with auto false echo suppression.

beam angle: the angle diametrically subtended by the one-half power limits (-3 dB) of the sound beam.

beam spreading: the divergence of a beam as it travels through a medium.

blanking: a blind zone extending away from the reference point plus any additional shield length. The instrument is programmed to ignore this zone.

capacitance: the property of a system of conductors and dielectrics that permits the storage of electricity when potential differences exist between the conductors. Its value is expressed as the ratio of a quantity of electricity to a potential difference, and the unit is a Farad.

confidence: describes the quality of an echo. Higher values represent higher quality. Confidence threshold defines the minimum value.

damping: term applied to the performance of an instrument to denote the manner in which the measurement settles to its steady indication after a change in the value of the level.

dB (decibel): a unit used to measure the amplitude of signals.

derating: to decrease a rating suitable for normal conditions according to guidelines specified for different conditions.

dielectric: a nonconductor of direct electric current.¹

dielectric constant (DK): the ability of a dielectric to store electrical potential energy under the influence of an electric field. Also known as Relative Permittivity. An increase in the dielectric constant is directly proportional to an increase in signal amplitude. The value is usually given relative to a vacuum /dry air: the dielectric constant of air is 1¹.

echo: a signal that has been reflected with sufficient magnitude and delay to be perceived in some manner as a signal distinct from that directly transmitted. Echoes are frequently measured in decibels relative to the directly transmitted signal.

echo confidence: the recognition of the validity of the echo. A measure of echo reliability.

Echo Lock Window: a window centered on an echo in order to locate and display the echo's position and true reading. Echoes outside the window are not immediately processed.

Echo Marker: a marker that points to the processed echo.

Echo Processing: the process by which the radar unit determines echoes.

Echo Strength: describes the strength of the selected echo in dB above 1 μ V rms.

Echo Profile: a graphical display of a processed echo.

electrical noise: unwanted electrical signals that produce undesirable effects in the circuit or the control systems in which they occur

false echo: any echo which is not the echo from the desired target. Generally, false echoes are created by vessel obstructions.

1. Many conductive liquids/electrolytes exhibit dielectric properties; the relative dielectric constant of water is 80.

frequency: the number of periods occurring per unit time. Frequency may be stated in cycles per second.

hertz (Hz): unit of frequency, one cycle per second. 1 Gigahertz (GHz) is equal to 10^9 Hz.

HART: Highway Addressable Remote Transducer. An open communication protocol used to address field instruments.

inductance: the property of an electric circuit by virtue of which a varying current induces an electromotive force in that circuit or in a neighboring circuit. The unit is a Henry.

microwaves: the term for the electromagnetic frequencies occupying the portion of the radio frequency spectrum from 1 GHz to 300 GHz.

multiple echoes: secondary echoes that appear as double, triple, or quadruple echoes in the distance from the target echo.

Near Blanking: see Blanking

nozzle: a length of pipe mounted onto a vessel that supports the flange.

parameters: in programming, variables that are given constant values for specific purposes or processes.

polarization: the property of a radiated electromagnetic wave describing the time-varying direction and amplitude of the electric field vector.

polarization error: the error arising from the transmission or reception of an electromagnetic wave having a polarization other than that intended for the system.

propagation factor (pf): where the maximum velocity is 1.0, pf is a value that represents a reduction in propagation velocity as a result of the wave travelling through a pipe or medium.

pulse: a wave that departs from an initial level for a limited duration of time, and returns to the initial level

pulse radar: a radar type that directly measures distance using short microwave pulses. Distance is determined by the return transmit time.

radar: radar is an acronym for **RA**dio **D**etection **A**nd **R**anging. A device that radiates electromagnetic waves and utilizes the reflection of such waves from distant objects to determine their existence or position.

range: distance between a transmitter and a target.

range extension: the distance below the zero percent or empty point in a vessel.

relative permittivity: see dielectric constant

repeatability: the closeness of agreement among repeated measurements of the same variable under the same conditions.

speed of light: the speed of electromagnetic waves (including microwave and light in free space). Light speed is a constant 299, 792, 458 meters per second.

stillpipe: see **stilling-well**.

stilling-well: a pipe that is mounted inside a vessel, parallel to the vessel wall and open to the vessel at the bottom.

two wire radar: a low-energy radar. Can be loop powered, analog, intrinsically safe 4 to 20 mA, or a digital (BUS) transmitter.

TVT (time varying threshold): a time-varying curve that determines the threshold level above which echoes are determined to be valid.

Index

A

- Abbreviations and Identifications
 - list 2
- agitator blade detection
 - avoiding 57
- agitators 57
- algorithm
 - select for true echo 62
- analog output
 - in RUN mode 96
 - response rate 93
- application examples
 - horizontal tank with volume 32
 - liquid resin in storage vessel 30
- ARROW keys
 - primary/secondary index function 36
- Auto False-Echo Suppression 94
 - application 28
- auxiliary reading
 - parameter function key 19
 - PROGRAM mode 19

B

- beam angle 13
- beam spreading 13
- blanking 93
 - extending 60
- breakpoints
 - level 45
 - volume 46

C

- cables
 - requirements 17
- changing parameter values 23, 24
- cleaning
 - instructions 91
- conduits
 - requirements 17
- confidence value 93

D

- damping 56
- device description
 - HART 75
- distance measurement 38

E

- echo confidence
 - display 19
 - set threshold 61

- echo confidence reading 61
- echo quality parameters
 - update 20
- echo strength
 - update 61
- echo verification 39
- emission cone
 - requirements 13
- enclosure
 - rotating 14

F

- Failsafe
 - function 97
 - output options 97
 - timer 97
- false echoes 94
 - set TVT curve to ignore 94
- false-echo suppression
 - setting 64
- function keys
 - CLEAR 20
 - decimal point 20
 - negative value 20
 - toggle units or percent 20
 - update echo quality parameters 20
- function keys (RUN)
 - auxiliary reading parameter 19
 - display echo confidence 19
 - internal enclosure temperature 19
 - mA output display 19

H

- hand programmer
 - instructions 22
- HART
 - device description 75

HART Address 59

HART Communications details 75

- hazardous area installations
 - wiring requirements 100

I

- Identifications and Abbreviations
 - list 2
- installation
 - hazardous area requirements 100
 - requirements 11
- internal enclosure temperature
 - display 19

L

- level measurement 38
- lock value 47

locking collar 14, 17
loop resistance 102
loop voltage versus loop resistance
power supply requirements 102
loss of echo
definition 93

M

mA output
display 19
mA output in RUN mode 96
maintenance
cleaning 91
maintenance settings 79
master reset 23, 68
material mixers 57
measurement response 93
mounting (standard)
horn antennas 14
shielded rod 14

N

near blanking 93
extending 60

O

operation
measurement modes 38

P

PDM 79
percent
toggle units or percent 20
power source
requirements 16
power supply requirements
loop voltage versus loop resistance 102
primary index 35
accessing 35
changing a value 35
primary reading
PROGRAM mode 19
programming
disable 21
enable 21
programming chart 72
programming indicator 19
propagation factor 54

Q

quick start programming 24

R

range extension 60
to obtain reliable echo 94
receiver signal 93

resetting a parameter to factory setting 23

S

safety barrier selection 102
secondary index 35
accessing 36
changing value 36
secondary reading
PROGRAM mode 19
security
lock value 47
unlock value 47

SIMATIC PDM 79

SITRANS Probe LR
operating principles 92
overview 4

space measurement 38

T

temperature specification
Ambient/Operating 12
threshold value 93
transceiver 92
troubleshooting
communications 81
operation 88

TVT curve 94

U

units
toggle units or percent 20
unlock value 47

V

vessel shape
conical bottoms 60
conical top 12
parabolic bottoms 60
parabolic top 12
selection 43
volume measurement 38

W

wire gauge 17
wiring
cables 17
hazardous areas 100

Z

zener diode safety barriers 101

For more information

www.siemens.com/level

www.siemens.com/weighing

Siemens AG
Industry Sector
1954 Technology Drive
P.O. Box 4225
Peterborough, ON
Canada K9J 7B1

email: techpubs.smpi@siemens.com

www.siemens.com/processautomation

Subject to change without prior notice
7ML19985HR02 Rev. 2.5

© Siemens AG 2011



7 M L 1 9 9 8 5 H R 0 2
Printed in Canada