

2101 Field Wizard

Installation and Operation Guide



Part #60-2003-155 of Assembly #60-2004-070
Copyright © 2002. All rights reserved, Teledyne Isco, Inc.
Revision K, March 25, 2007

Foreword

This instruction manual is designed to help you gain a thorough understanding of the operation of the equipment. Teledyne Isco recommends that you read this manual completely before placing the equipment in service.

Although Teledyne Isco designs reliability into all equipment, there is always the possibility of a malfunction. This manual may help in diagnosing and repairing the malfunction.

If the problem persists, call or e-mail the Teledyne Isco Technical Service Department for assistance. Simple difficulties can often be diagnosed over the phone.

If it is necessary to return the equipment to the factory for service, please follow the shipping instructions provided by the Customer Service Department, including the use of the **Return Authorization Number** specified. **Be sure to include a note describing the malfunction.** This will aid in the prompt repair and return of the equipment.

Teledyne Isco welcomes suggestions that would improve the information presented in this manual or enhance the operation of the equipment itself.

Teledyne Isco is continually improving its products and reserves the right to change product specifications, replacement parts, schematics, and instructions without notice.

Contact Information

Customer Service

Phone: (800) 228-4373 (USA, Canada, Mexico)
(402) 464-0231 (Outside North America)
Fax: (402) 465-3022
Email: IscoCSR@teledyne.com

Technical Service

Phone: (800) 775-2965 (Analytical)
(800) 228-4373 (Samplers and Flow Meters)
Email: IscoService@teledyne.com

Return equipment to: 4700 Superior Street, Lincoln, NE 68504-1398

Other Correspondence

Mail to: P.O. Box 82531, Lincoln, NE 68501-2531
Email: IscoInfo@teledyne.com
Web site: www.isco.com

2101 Field Wizard

Table of Contents

Section 1 Introduction

1.1 Introduction	1-1
1.2 Product Description	1-1
1.3 Identifying Module Components	1-2
1.4 Safety Symbols and Hazard Alerts	1-6
1.5 Technical Service	1-6

Section 2 Preparation and Installation

2.1 Unpacking Instructions	2-1
2.2 Safety	2-2
2.3 Connecting To Flowlink	2-2
2.4 Connecting To a Site	2-4
2.4.1 Latches - Locking and Unlocking	2-5
2.4.2 Communication Connectors	2-7
2.4.3 Stacking Modules	2-7

Section 3 Operation

3.1 Introduction	3-1
3.2 Field Wizard Keypad	3-1
3.3 Flowlink Connection	3-3
3.3.1 Connecting To a PC	3-3
3.3.2 Communication Resolution	3-5
3.3.3 Site and Module Name	3-5
3.4 Connecting to a Site	3-6
3.5 Site Time Synchronization	3-7
3.6 Data Retrieval Mode	3-7
3.6.1 Retrieve Data Display	3-9
3.6.2 Data Retrieval Log Display	3-11
3.6.3 Site Setup Display	3-12
3.6.4 Data Display	3-15
3.6.5 Site Information Display	3-16
3.7 Standalone Mode	3-16
3.7.1 Standalone Information Display	3-17
3.8 PC Data Synchronization Mode	3-17

Section 4 Modbus Protocol

4.1 Introduction	4-1
4.2 Operation	4-1
4.2.1 Establishing Communication	4-2
4.2.2 Module Addressing	4-2
4.3 Configurations	4-3
4.4 Glossary of Terms	4-4
4.5 Common Acronyms	4-5
4.6 Register Specifications	4-6

Section 5 Maintenance

5.1 Maintenance Overview	5-1
5.1.1 Cleaning	5-1
5.2 Maintenance Kit	5-1
5.3 Desiccant	5-2
5.3.1 Replacing the Desiccant: 2101	5-2
5.3.2 Reactivating the Desiccant	5-2
5.4 Hydrophobic Filter	5-3
5.5 How to Obtain Service	5-3

Appendix A Replacement Parts

A.1 Replacement Parts	A-1
-----------------------	-----

Appendix B Accessories

B.1 How to Order	B-1
B.2 General Accessories	B-1

Appendix C Material Safety Data Sheets

C.1 Overview	C-1
--------------	-----

List of Figures

1-1 Field Wizard Keypad and Display	1-2
1-2 Field Wizard Components - Side View	1-3
1-3 Field Wizard Components - Bottom View	1-4
1-4 Model 2101 Field Wizard Connector Pins	1-5
2-1 Connecting the AC Adapter to the Field Wizard	2-3
2-2 Connecting the Communication Cable to the Field Wizard	2-3
2-3 Flowlink Site Info Screen	2-4
2-4 Data Retrieval Mode Main Display	2-10
3-1 Field Wizard Keypad and Display	3-2
3-2 Flowlink Site Info Screen	3-4
3-3 Field Wizard Connected to a 2150 Site	3-6
3-4 Synchronize Time Display	3-7
3-5 Data Retrieval Mode Main Display	3-8
3-6 Retrieve Data Display	3-9
3-7 Data Retrieval Status Display	3-9
3-8 Retrieve # Days Display	3-10
3-9 Log Display	3-11
3-10 Data Log Details Display	3-12
3-11 Field Wizard Site Setup Display	3-13
3-12 Field Wizard Backlight Mode Settings	3-13
3-13 Site Setup Display	3-14
3-14 Level Calibration Display	3-14
3-15 Sensor Diagnostics Display	3-15
3-16 Data Display	3-15
3-17 Site Information Display	3-16
3-18 Standalone Mode Main Display	3-16
3-19 Standalone Information Display	3-17
3-20 PC Data Synchronization Mode Display	3-17
4-1 Configuration Example (Direct Connection Shown)	4-3

List of Tables

1-1	Field Wizard Components - Side View	1-3
1-2	Field Wizard Components - Bottom View	1-4
1-3	2101 Field Wizard Technical Specifications	1-5
1-4	Field Wizard Connector Pins	1-5
4-1	Modbus ASCII Address 1 Register Definitions	4-6
4-2	Modbus ASCII Address 2-(N+1) Register Definitions	4-7
4-3	Measurement Parameters by Model Number*	4-9

2101 Field Wizard

Section 1 Introduction

1.1 Introduction

This instruction manual is designed to help you gain a thorough understanding of the operation of the 2101 Field Wizard. Teledyne Isco recommends that you read this manual completely before placing the equipment into service.

1.2 Product Description

The 2101 Field Wizard is a portable data interrogation unit designed to collect data from Isco's 2100 Series flow modules, which measure parameters of open channel flow streams. It then transfers that data to Isco's *Flowlink 4 for Windows* software.

The Field Wizard also serves as a local display and keypad for a 2100 Series site. The eight-line by forty-character graphics display provides quick access to current readings and diagnostic information, and allows for calibration of level measurements.

The Field Wizard stacks on top of a 2100 Series module, using the same locking mechanism that connects the 2100 Series modules to each other. Because modules have unique assigned names, the Field Wizard can retrieve data from multiple modules and can be easily moved from site to site.

The Field Wizard uses flash memory, which retains data without the concern of power failures or aging backup batteries. The data storage memory can hold up to fourteen days worth of data recorded at fifteen minute intervals from twenty different modules.

All enclosures are rated NEMA 4X, 6P and IP68. The permanently sealed enclosures are designed to meet the environmental demands of many sewer flow monitoring applications. All connections between modules, sensors, and communication cables "lock" in place. The locking mechanisms strongly secure the components and ensure a watertight seal.

Its rugged, compact design and simplicity of use make the Field Wizard a convenient alternative to using a laptop computer for displaying site data or transferring data from the 2100 Series module to a personal computer.

1.3 Identifying Module Components

Figures 1-2 through 1-3 identify the key components of the 2101 Field Wizard.

The Field Wizard is operated from the top panel, which contains a keypad and liquid crystal display. The keypad, shown in Figure 1-1, includes 26 keys that are used to program and operate the Field Wizard.

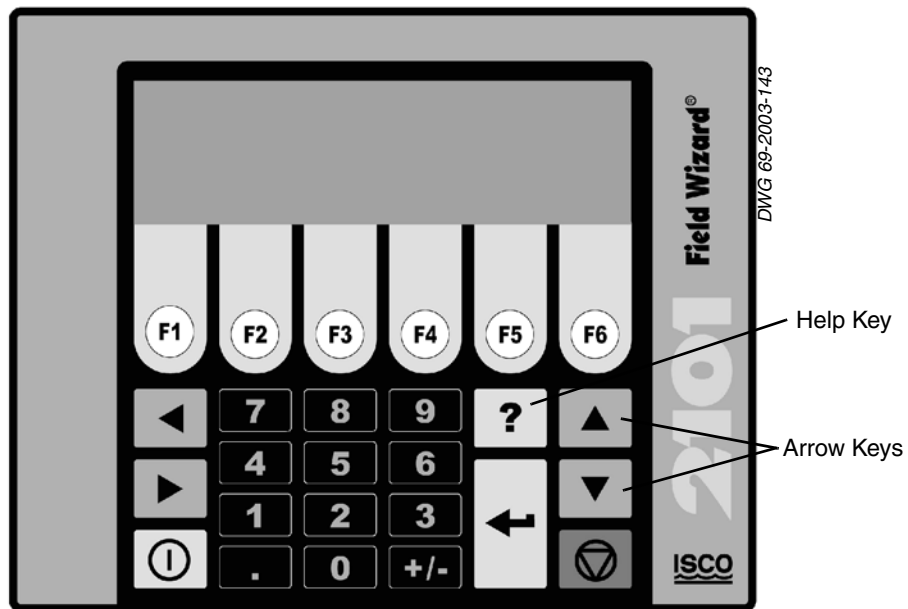

Figure 1-1 Field Wizard Keypad and Display

The keypad contains six software configured function keys (soft keys) that are used to make selections and navigate through menus. Their specific functions will depend upon what operation you are performing, and will be shown in the display window.

The four arrow keys are used for navigation within menus and displays. The Enter key is used to complete data entry, acknowledge prompts, and signal the start of certain operations. Numeric keys are active when numeric data is to be entered. Press the Help key to obtain context sensitive help.

The Power key places the unit into an ultra low power state, during which the display window will be blank.

The Escape key is not currently used. During some operations, one of the function keys will serve as a Cancel key.

The unit is equipped with an audible beeper. The beeper acknowledges key presses, and signals errors when incorrect entries are made.



Figure 1-2 Field Wizard Components - Side View

Table 1-1 Field Wizard Components - Side View		
Item No.	Name	Description
1	Communication Connector	This port is used to connect to a personal computer running Flowlink software.
2	Connector Cap	Insert into the communication connector when it is not in use to protect the connector from damage.
3	Latch Release	Push in to unlock the module from a stack.

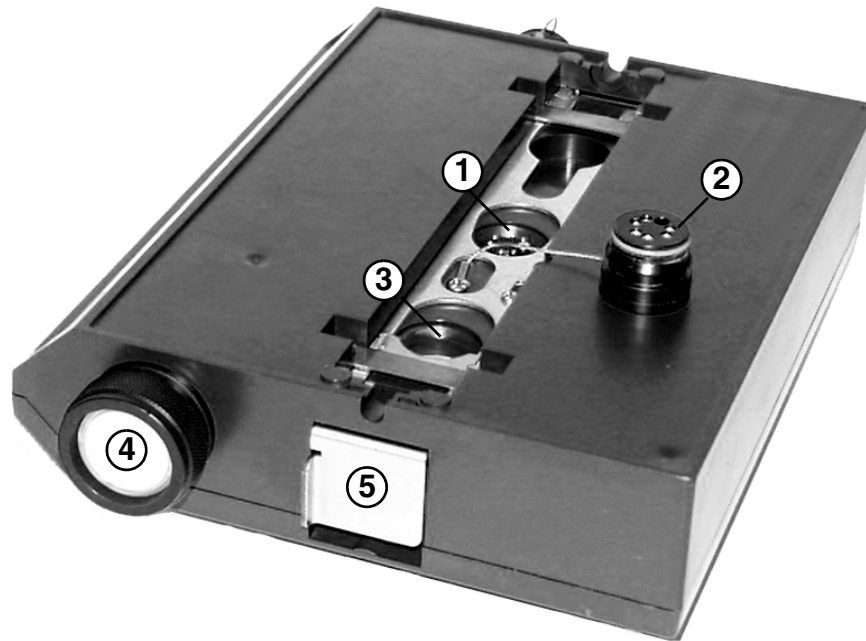

Figure 1-3 Field Wizard Components - Bottom View

Table 1-2 Field Wizard Components - Bottom View		
Item No.	Name	Description
1	Communication Connector	This connects the Field Wizard to the 2100 Series module and is used to transfer data.
2	Connector Cap	Insert into the communication connector when not in use to protect the connector from moisture damage. When the connector is in use, store the connector cap in the cap holder.
3	Cap Holder	Stores the connector cap when the communication connector is in use.
4	Desiccant Cartridge and Hydrophobic Filter	Prevents moisture from entering the unit.
5	Latch	Push in to lock the module in a stack.

Table 1-3 2101 Field Wizard Technical Specifications	
Dimensions	Length = 11.3 inches (28.70 cm) Width = 7.5 inches (19.05 cm) Height = 2.9 inches (7.37 cm)
Weight	2 lbs. (.9 Kg)
Material	High-impact molded polystyrene
Enclosure	NEMA 4X, 6P, IP68
Power	6.6 to 16.6 VDC, 110 mA typical at 12 VDC, 1 mA standby
Operating Temperature	-4° to 140°F (-20° to 60°C)
Storage Temperature	-40° to 140°F (-40° to 60°C)
Setup and Data Retrieval	Serial connection to IBM PC or compatible computer with Isco <i>Flowlink</i> software version 4.12 or higher
Baud Rate	38,400
File System Memory Capacity	The Field Wizard is capable of storing a minimum of 1.5 Mbytes of data.

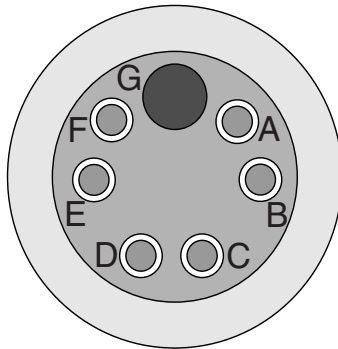

Figure 1-4 Model 2101 Field Wizard Connector Pins

Table 1-4 Field Wizard Connector Pins		
Pin	Name	Description
A	LONA	Neuron differential transceiver Data A
B	LONB	Neuron differential transceiver Data B
C	VIN+	Positive power supply voltage input (+12 VDC nominal)
D	VIN-	Negative power supply voltage input (0 VDC nominal)
E	RCVUP	PC data receiver inverted input
F	XMTUP	PC data transmit inverted output
G	Key	Aligns connector pins

1.4 Safety Symbols and Hazard Alerts



This icon identifies a general hazard and is accompanied with details about the hazard. The instruction manual identifies the hazardous condition and any steps necessary to correct the condition. The manual presents this information in one of two ways:

CAUTION

Cautions identify a potential hazard, which if not avoided, may result in minor or moderate injury. This category can also warn you of unsafe practices, or conditions that may cause property damage.

WARNING

Warnings indicate potentially hazardous conditions. If you do not avoid these risks, they could cause you death or serious injury.

1.5 Technical Service

Although Teledyne Isco designs reliability into all of its equipment, there is always the possibility of a malfunction occurring. You can use this manual to help in diagnosing and repairing any malfunctions. If the malfunction persists, call or write the Teledyne Isco Technical Service Department for assistance:

Teledyne Isco Inc.
Technical Service Department
P.O. Box 82531
Lincoln, NE 68501
800-228-4373 or 402-464-0231
FAX: 402-465-3001
E-MAIL: service@isco.com

Simple difficulties can often be diagnosed over the phone. If it is necessary to return the equipment to the factory for service, please follow the shipping instructions provided by the Technical Service Department, including the use of the Return Authorization Number specified. Be sure to include a note describing the malfunction. This will aid in the prompt repair and return of the equipment.

2101 Field Wizard

Section 2 Preparation and Installation

2.1 Unpacking Instructions

When the system arrives, inspect the contents for any damage. If there is damage, contact the delivery company and Teledyne Isco (or its agent) immediately.

 WARNING
--

If there is any evidence that any items may have been damaged in shipping, do not attempt to install the unit. Please contact Teledyne Isco (or its agent) for advice.

Teledyne Isco, Inc.
Customer Service Dept.
P.O. Box 82531
Lincoln, NE 68501 USA

Phone: (800) 228-4373
Outside USA & Canada call:
(402) 464-0231

FAX: (402) 465-3022

E-mail: info@isco.com

When you unpack the system, check the items against the packing list. If any parts are missing, contact the delivery company and Teledyne Isco's Customer Service Department. When you report missing part(s), please indicate them by part number. In addition to the main packing list, there may be other packing lists for various sub-components.

It is recommended that you retain the shipping cartons as they can be used to ship the unit in the event that it is necessary to transport the system.

Please complete the registration card and return it to Teledyne Isco, Inc.

2.2 Safety

 **WARNING**

Avoid hazardous practices! If you use these instruments in any way not specified in this manual, the protection provided by the instruments may be impaired; this will increase your risk of injury.

 **WARNING**

The installation and use of this product may subject you to hazardous working conditions that can cause you serious or fatal injuries. Take any necessary precautions before entering a worksite. Install and operate this product in accordance with all applicable safety and health regulations, and local ordinances.

The 2100 Series components are often installed in confined spaces. Some examples of confined spaces include manholes, pipelines, digesters, and storage tanks. These spaces may become hazardous environments that can prove fatal for those unprepared. These spaces are governed by OSHA 1910.146 and require a permit before entering.

2.3 Connecting To Flowlink

Before you use your Field Wizard in the field to collect data, you need to synchronize it to Isco's Flowlink software on a personal computer (PC).

Use the following instructions to connect to Flowlink for the first time. More detailed information about transferring data to Flowlink can be found in Section 3.3.

Use Isco's communication cable P/N 60-2004-046 and AC Adapter (P/N 60-2004-057) to connect the Field Wizard to a PC, as shown in Figures 2-1 and 2-2.

Uncap the communication connector on the underside of the Field Wizard, and store the connector cap in its holder. Then plug the AC Adapter into the communication connector, as shown in Figure 2-1. Plug the other end of the AC Adapter into a grounded electrical outlet.



Figure 2-1 Connecting the AC Adapter to the Field Wizard



Figure 2-2 Connecting the Communication Cable to the Field Wizard

Uncap the communication connector on the right side of the Field Wizard and attach the Communications Cable, as shown in Figure 2-2. Connect the other end of the Communications Cable to a serial COM port on the PC.

As a default Flowlink setting, the Quick Connect dialog box opens when you start Flowlink. (If it is not open, click the Quick Connect icon or select File, Quick Connect.)

Click the large *Field Wizard* button to connect. Flowlink will read the 2101 system information and try to match it with an existing site in the open database. It will then display the *Site Info* tab of the Site Window (Figure 2-3).

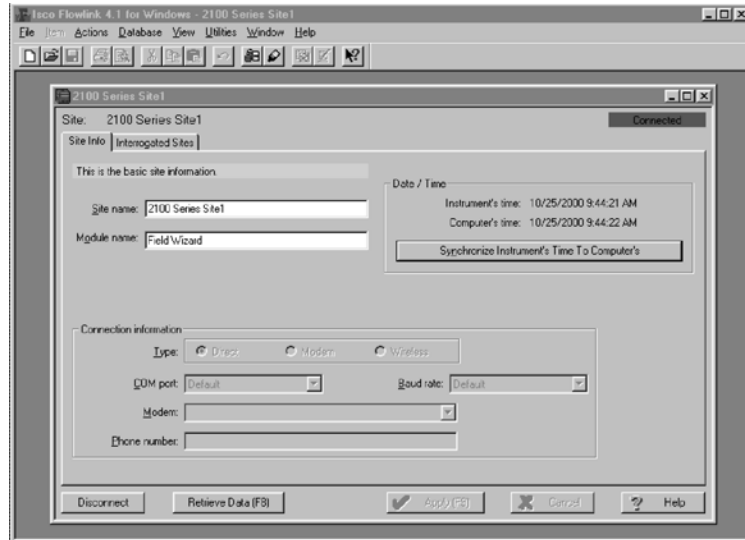

Figure 2-3 Flowlink Site Info Screen

Complete the following steps:

1. Click the **Synchronize Instrument's Time to Computer's** button to synchronize the Field Wizard's time to that of your PC. (If you are using multiple PCs, select just one PC to synchronize with.)
2. The Field Wizard is shipped with default site and module names. Use the **Site Name** and **Module Name** fields if you want to provide more descriptive names. Select **Apply (F9)** to write that information to the instrument.
3. Although data has not yet been collected, you need to click **Retrieve Data (F8)**. This transfers a file containing site interrogation times from Flowlink to the Field Wizard. With this information, the Field Wizard will know when data was last retrieved from your site(s). When brought to a site, the Field Wizard will then retrieve only the necessary data.
4. Select **Disconnect** to end your PC session and disconnect the Field Wizard.

2.4 Connecting To a Site

Once you have connected the Field Wizard to Flowlink and set up the initial configuration, you can connect the Field Wizard to a site and retrieve data.

The Field Wizard module connects to the top of a 2100 Series stack, which may contain multiple modules. The steps shown in Sections 2.4.1 - 2.4.3 illustrate how to operate latches and connectors and connect the Field Wizard to the site.

2.4.1 Latches - Locking and Unlocking

Latches must be operated to stack and unstack the modules in a Series 2100 stack. The mechanisms are the same for the Field Wizard and other 2100 Series modules. Take a moment to familiarize yourself with operating the latches. The latch is operated by pushing on one of the sides — the right side to unlock, and the left side to lock.

 **CAUTION**

The latch can be damaged by applying too much force. Never press on both sides at the same time. Do not force the latch if it is obstructed. While some degree of pressure must be applied to slide the latch, the ends of the latches should never bend more than $\frac{1}{8}$ ".

L'attache peut-être endommagée en la forçant. Ne jamais presser simultanément des deux côtés à la fois. Ne pas forcer en cas de résistance. Ne jamais tordre les extrémités des attaches de plus de 3 mm.

Figure 2-4 shows how to unlock the latch. You must unlock the latch to place the module on top of a stack. Otherwise, the latch is normally locked.

Figure 2-5 shows how to lock the latch.

 **Note**

Latches will “click” when they are fully locked and unlocked.

**Figure 2-1:
Unlocking the latch**

Locate the latch release on the right side of the module. Push in to slide the latch toward the left of the module.



**Figure 2-2:
Locking the latch**

Locate the latch extending from the left side of the module. Push in to slide the latch toward the right of the module.



2.4.2 Communication Connectors

Connecting the Field Wizard module involves uncapping and capping communication connectors. When a communication connector is not in use, the connector should always be capped (Figures 2-6 and 2-8). The cap will seal the connector to prevent corrosion, and will improve communications.

When a communication connector is in use, store the cap on the holder next to the connector (Figures 2-7 and 2-9). The communication connector will be sealed by its mating connector.

CAUTION

Caps **PUSH ON** and **PULL OFF**. Do not rotate the caps to remove them from the connectors.

Capuchons **POUSSER** et **TIRER**. Ne pas tourner les capuchons pour les enlever des prises.

Note

For modules to correctly stack and lock together, protective caps between the modules must be stored on the holders.

Figure 2-3:
2100 Series Module's Upper Connector - Capped

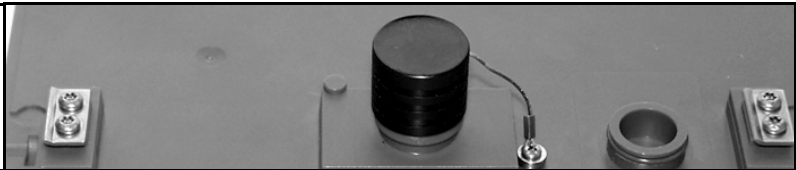

Figure 2-4:
2100 Series Module's Upper Connector - Uncapped

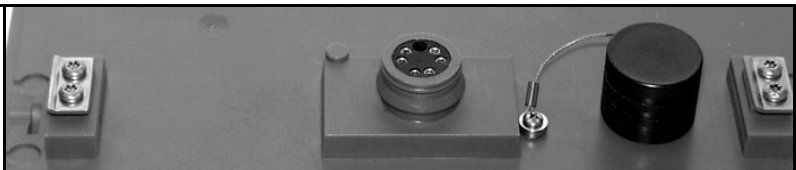

Figure 2-5:
Field Wizard's Lower Connector - Capped

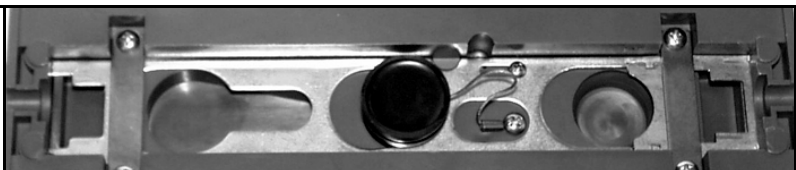
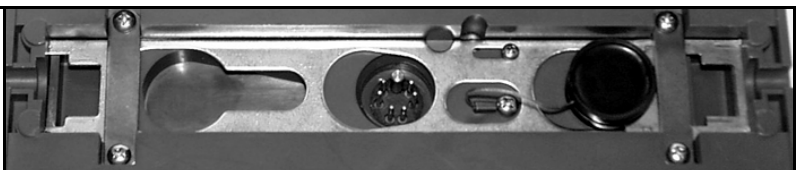

Figure 2-6:
Field Wizard's Lower Connector - Uncapped



2.4.3 Stacking Modules

To stack a Field Wizard Module on a 2100 Series Module, follow the instructions in Figures 2-10 through 2-17.

Figure 2-7:
Field Wizard module -
unlock the latch

Unlock the latch to release the lower cap.

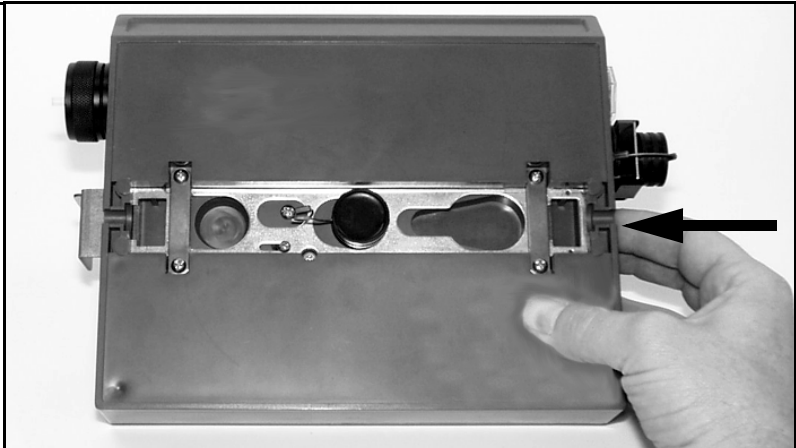

Figure 2-8:
Field Wizard module -
uncap the connector

Pull the cap off of the connector.

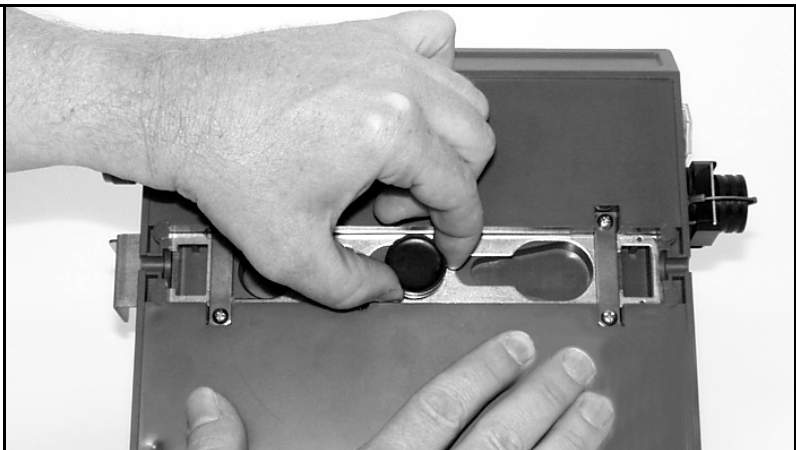

Figure 2-9:
Field Wizard module -
push cap into holder

Push the cap into the holder.

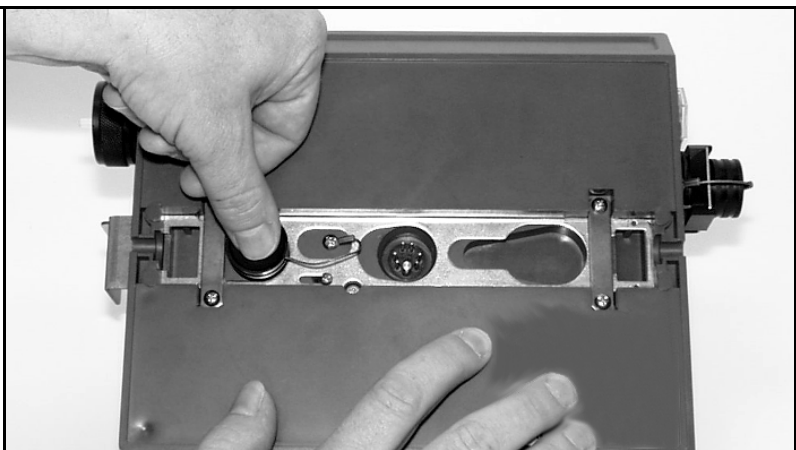

Figure 2-10:
2100 Series Module -
uncap the connector

Uncap the connector on the top 2100 Series module. Store the cap on the holder.

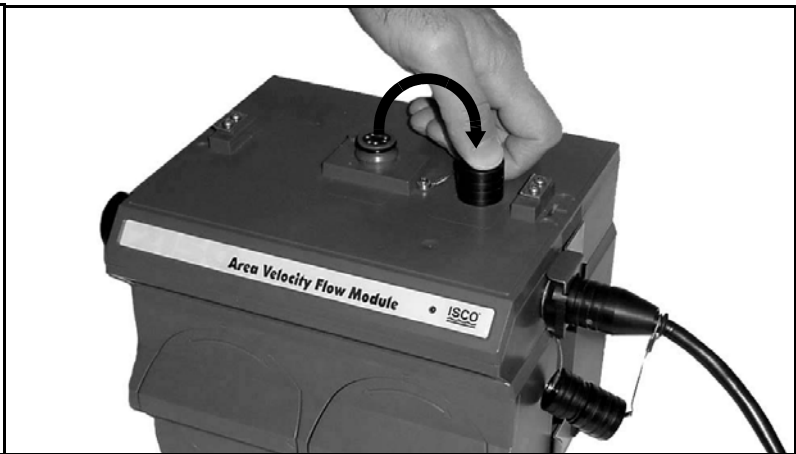

Figure 2-11:
Align the modules

Align the modules and gently press the Field Wizard Module onto the 2100 Series Module.

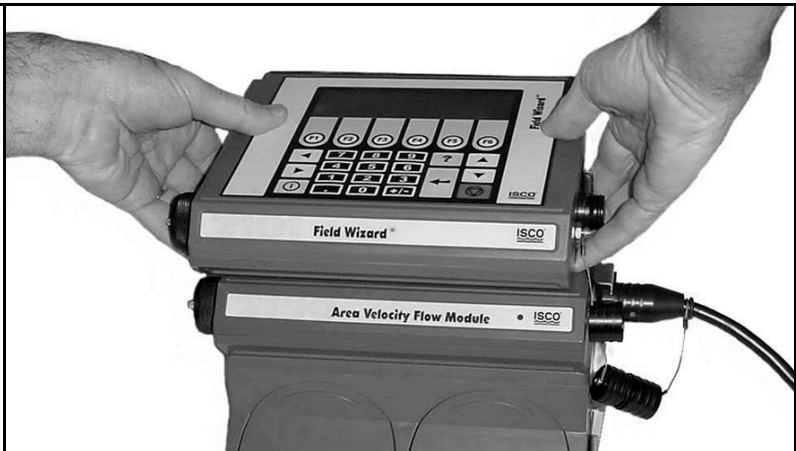
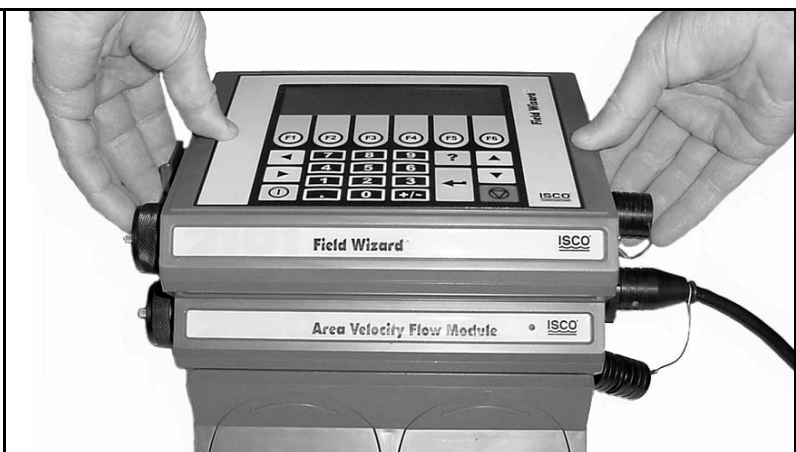

Figure 2-12:
Push down and lock
the latch

While gently pressing down on the stack, lock the Field Wizard Module's latch.



When the Field Wizard is connected to the site, you will hear a beep and then see the display “PLEASE WAIT...” as the unit queries the site for configuration information. When it has obtained that information, it will format it into a display similar to that in Figure 2-18.

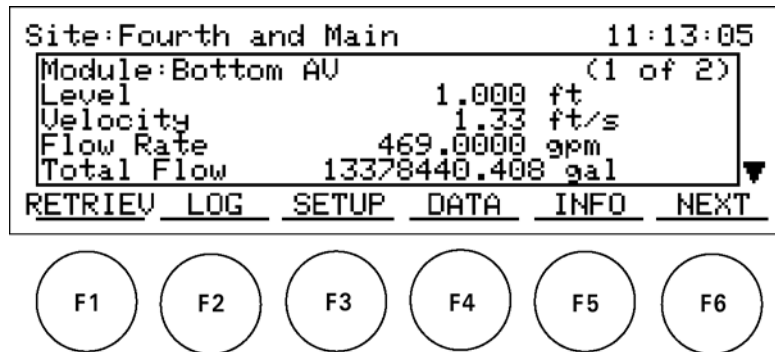

Figure 2-4 Data Retrieval Mode Main Display

More details about operating the Field Wizard at a site can be found in Section 3.4.

2101 Field Wizard

Section 3 Operation

3.1 Introduction

This section describes how to use a 2101 Field Wizard with Isco's Flowlink software, and how to operate the Field Wizard in the field.

 **Note**

The Field Wizard requires Flowlink 4.12 or later. Earlier versions do not support the Field Wizard. The Field Wizard also requires that the 2100 Series modules it connects to have a code version 1.06 or greater.

Flowlink Help

Detailed Flowlink instructions are beyond the scope of this manual. Flowlink's operating instructions are available in a Windows Help format. You can access the help topics for an active window by clicking on its *Help* button or by pressing F1 on your computer's keyboard. You can also access Help topics by selecting Help from the Flowlink menu.

3.2 Field Wizard Keypad

The Field Wizard is operated from the top panel, which contains a keypad and liquid crystal display.

The keypad, shown in Figure 3-1, includes 26 keys that are used to operate the Field Wizard.

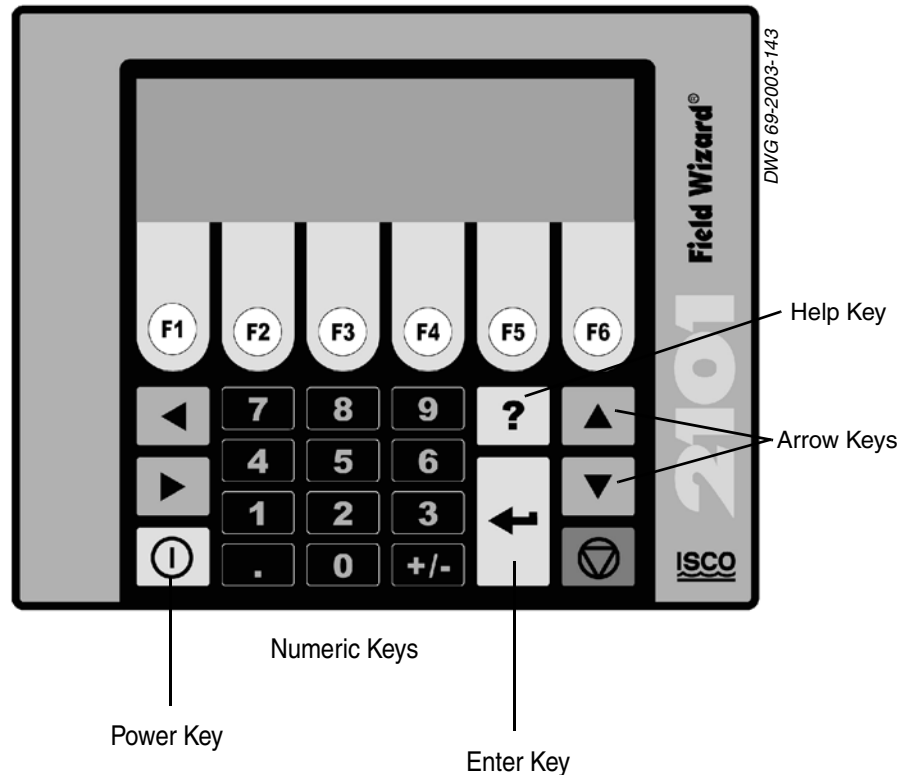

Figure 3-1 Field Wizard Keypad and Display

The keypad contains six software configured function keys (soft keys) that are used to make selections and navigate through menus. Their specific functions will depend upon what operation you are performing, and will be shown in the display window.

The four arrow keys are used for navigation. The Enter key is used to complete data entry, acknowledge prompts, and signal the start of certain operations. Numeric keys are active when numeric data is to be entered.

The key with a question mark on it is the Help key. Press it to obtain context sensitive help while using the Field Wizard. When you are in Help mode, use the directional arrow keys to scroll through the information displayed. Press the Help key again to exit the Help mode.

The Power key places the unit into an ultra low power state, during which the display window will be blank.

The Escape key is not currently used. During some operations, one of the function keys will serve as a Cancel or Exit key.

The unit is equipped with an audible beeper. The beeper acknowledges key presses, and signals errors when incorrect entries are made.

 **Note**

If the display is difficult to read, adjust its contrast by holding down the Plus/Minus (+/-) key while pressing the Down or Up Arrow key until you obtain the desired lighting level.

3.3 Flowlink Connection

Before taking the Field Wizard to a site to collect data *for the first time*, you need to configure it to your Flowlink software. This will let you synchronize the Field Wizard's date and time with that on your personal computer (PC) and assign a module name to the Field Wizard for identification. On subsequent connections, Flowlink will recognize the Field Wizard from information stored in its database.

The Field Wizard operates as an extension to Flowlink's Master Data Base on your PC, which synchronizes the measurement and collection of data for all sites under its management. This centralized control insures that all measured data is collected from a site, and that measurements are taken when expected.

 **Note**

If you will be using the Field Wizard to transfer data to multiple computers, you should designate one computer as the master and connect the Field Wizard to it first. This will avoid problems with synchronizing the date and time.

3.3.1 Connecting To a PC

To connect the Field Wizard to a PC, you will need Isco's communication cable P/N 60-2004-046 and AC Adapter P/N 60-2004-057.

One end of the AC adapter plugs into a grounded electrical outlet, and the other end connects to the communications connector on the underside of the Field Wizard.

One end of the communication cable connects to a serial port on your PC, and the other end connects to the communication connector on the right hand side of the Field Wizard.

Refer to Section 2.3 for more detailed instructions and diagrams on how to make these connections.

As a default Flowlink setting, the Quick Connect dialog box opens when you start Flowlink. (If it is not open, click the Quick Connect icon or select File, Quick Connect.)

Click the large *Field Wizard* button to connect. Flowlink will read the 2101 system information and try to match it with an existing site in the open database. It will then display the *Site Info* screen (Figure 3-2).

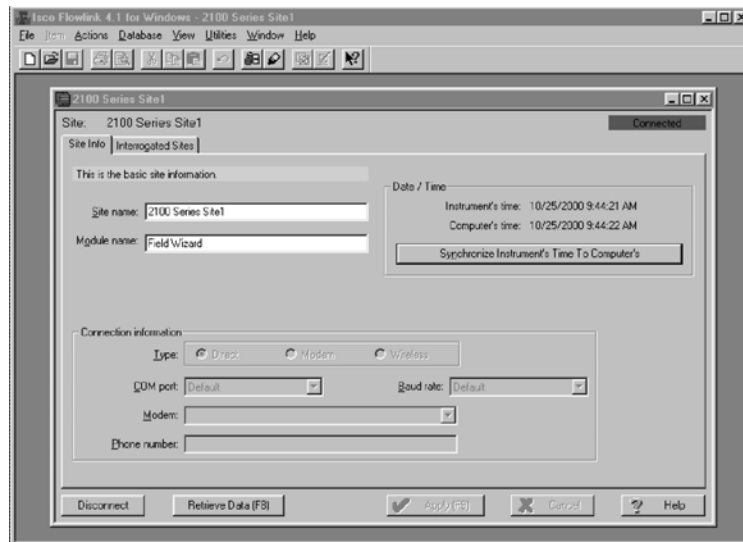

Figure 3-2 Flowlink Site Info Screen

Complete the following steps:

1. Click the **Synchronize Instrument's Time to Computer's** button to synchronize the Field Wizard's time to that of your PC. (If you are using multiple PCs, select just one PC to synchronize with.) You will be notified that this operation will set the time of the Field Wizard to match that of the PC. Click OK.
2. The Field Wizard is shipped with default site and module names. Use the **Site Name** and **Module Name** fields if you want to provide more descriptive names. Select **Apply (F9)** to write that information to the instrument.
3. Click **Retrieve Data (F8)** to retrieve the data from the Field Wizard. For synchronization purposes, this should be done even if this is the first time you are connecting the Field Wizard to the PC. The process transfers a file containing site interrogation times from Flowlink to the Field Wizard. With this information, the Field Wizard will know when data was last retrieved from your site(s). When brought to a site, the Field Wizard will retrieve only the necessary data.

The process will take some time. A gauge will be displayed so you can monitor the progress. If needed, click Cancel to cancel the data transfer. The data will be retained in the Field Wizard.

Data that has been retrieved by the PC will remain in the Field Wizard until it is connected to a site and begins collecting new data. This allows you to copy data to multiple PCs.

4. Select **Disconnect** to end your PC session and disconnect the Field Wizard.

3.3.2 Communication Resolution

During the connection process, Flowlink checks the stability of the site's communications. If communication is found to be unstable, Flowlink presents the *Communication Resolution* window.

There are two common causes of unstable communications. One cause is a Module Name conflict, which may occur when two or more modules at a site use the same module name. The second cause is a Site Name conflict, which occurs when a module added to the site indicates that it belongs to a different site.

The Communications Resolution window lets you choose how the modules should be reconfigured and which Site Name should be retained. To resolve the communications, select the sites and modules that should be reconfigured and click the OK button. Be aware that reconfiguring a module removes the Site Name, Module Name, program settings, *and any stored data*. The module is then restarted with the stable Site's Name, a default Module Name, and default program settings, and the data storage is ready to accept new data.

3.3.3 Site and Module Name

The Field Wizard is shipped with a default site and module name so it can immediately begin to communicate with Flowlink. You can change the names to something more descriptive using the **Site Name** and **Module Name** fields on the *Site Info* tab in Flowlink.

Keep in mind that the names must be unique among the other site and module names in the open Flowlink database. Site names can be up to 37 characters long. Any character may be used in the name except:

/	forward slash	\	back slash
:	colon	*	asterisk
?	question mark	"	double-quote
<	left angle bracket	>	right angle bracket
	bar		

3.4 Connecting to a Site

Once you have connected the Field Wizard to Flowlink and set up the initial configuration, you can connect the Field Wizard to a site and retrieve data.

To connect the Field Wizard, refer to the following instructions and to Figure 3-3. For more details and a series of photos showing the connection steps, refer to Section 2.4.



Figure 3-3 Field Wizard Connected to a 2150 Site

The Field Wizard module connects to the top of a 2100 Series stack, which may contain multiple 2100 Series Modules.

1. On the top 2100 Series Module, remove the connector cap from the communication connector and store the cap in its holder.
2. Unlock the Field Wizard's latch by pressing in on the latch release (right side).
3. Underneath the Field Wizard module, remove the cap from the communication connector and store the cap in its holder.
4. Lock the Field Wizard's latch by pressing in on the latch on the left side. This correctly seats and aligns the cap in its holder.
5. Position the Field Wizard over the 2100 Series Module. Align the connectors and lower the Field Wizard onto the Module.
6. Unlock the Field Wizard's latch.
7. Firmly press the modules together and lock the Field Wizard's latch.

3.5 Site Time Synchronization

The Field Wizard operates as an extension of the Master Data Base computer, which is responsible for synchronizing the measurement and collection of data for all sites under its management. This centralized control insures that all measured data is collected from a site, and that measurements are taken when expected.

When the Field Wizard is connected to a site, its date and time will be checked with that of the site. If the Field Wizard detects a time difference of more than one minute, the following screen will be displayed:

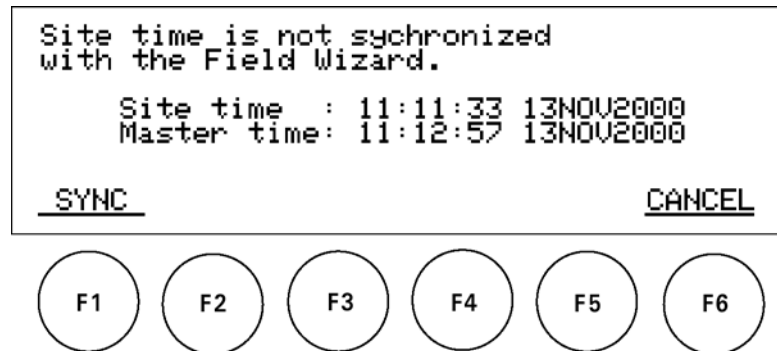

Figure 3-4 Synchronize Time Display

Press F1 SYNC to synchronize the site's time with that of the Field Wizard and the Master Computer. The time will be synchronized and you will be advanced to the Data Retrieval Mode Main Display (Fig. 3-5).

If you do not want to synchronize the time, press F6 CANCEL to advance to the Data Retrieval Mode Main Display (Fig. 3-5).

3.6 Data Retrieval Mode

The Field Wizard will be in data retrieval mode when collecting data from modules in the field. When the Field Wizard is connected to the site, you will hear a beep and then see the display "PLEASE WAIT..." as the unit queries the site for configuration information. When it has obtained that information, and assuming that the site's time is synchronized with the Field Wizard, you will see a display similar to that in Figure 3-5.

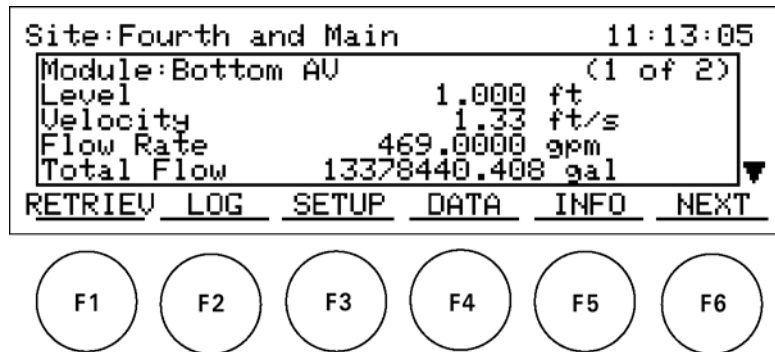

Figure 3-5 Data Retrieval Mode Main Display

On the *Data Retrieval Mode Main Display*, the site name and current time and date will be shown on the top line.

The module name and current measurement information will be shown in the window. If more than one module is detected, an indicator (**X of X**) after the module name will show what module is currently being displayed and the total number of modules found at the site.

All of the measurement data shown is live and will be updated every fifteen seconds. If the module has more information than can be displayed at one time, scroll arrows will appear on the right side of the screen. Pressing the **Up** and **Down** arrow keys will scroll through the complete information for that module. Press F6 NEXT to display data for the next module (if there are two or more 2100 Series modules).

The actions assigned to the function keys are summarized below. More complete descriptions are provided in the subsections that follow.

KEY	FUNCTION	DESCRIPTION
F1	RETRIEVE	Used to collect data from the site.
F2	LOG	Checks the status of currently stored data.
F3	SETUP	Used to maintain the site after setup on a PC.
F4	DATA	Displays data storage statistics.
F5	INFO	Examines system information about active modules.
F6	NEXT	Moves to next module when multiple modules exist; is not active when there is just one module at a site.

3.6.1 Retrieve Data Display

When you press F1 RETRIEVE from the Main Display, the window shown in Figure 3-6 will be displayed.

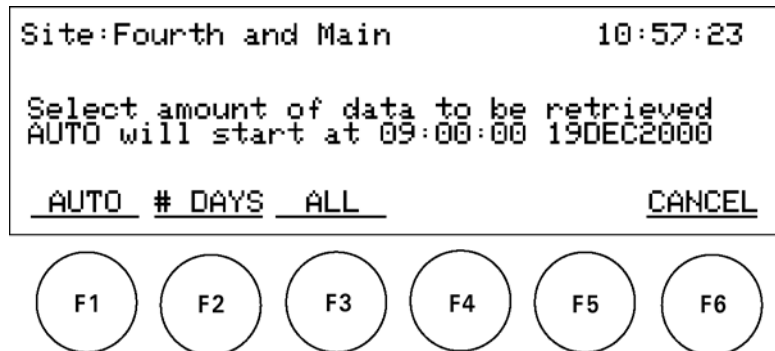

Figure 3-6 Retrieve Data Display

The Retrieve Data display has four function key options, as described below.

F1 AUTO – Press the F1 key to retrieve data from the starting point in time scheduled by the Master Data Base. This time is generated each time the Field Wizard transfers data to Flowlink. A message in the Field Wizard window will tell you the time and date that data collection will start if you select this option.

During data collection, the name of the module being interrogated will be displayed, along with a gauge so you can note the progress (see Figure 3-7).

If there is more than one module active at the site, then the data will be retrieved one module at a time. One module will be completely interrogated before data will be retrieved from any other module.

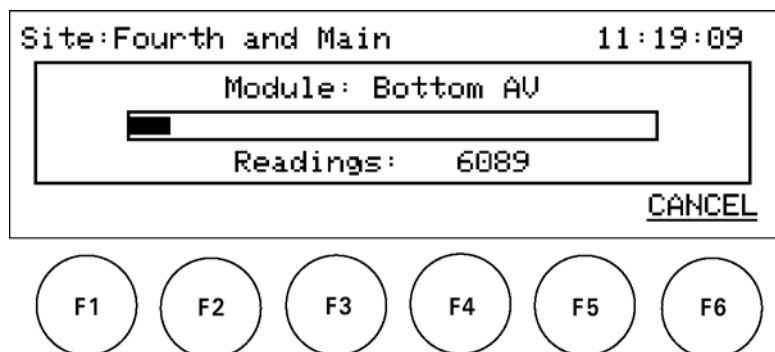

Figure 3-7 Data Retrieval Status Display

Information inside the status window will change as the interrogation process proceeds. As the data is being retrieved, both the gauge and number of readings will change.

If you want to cancel the data collection process, press F6. This will return you to the Main Display, and will save the data that has already been collected.

If the data being retrieved exceeds the Field Wizard's available memory, data retrieval will be terminated and you will be notified of an incomplete retrieval. All the data retrieved from the start time to the point memory was filled will be saved in the Field Wizard and can be downloaded to a PC.

When data collection is complete, an audible signal will sound, and you will be returned to the Main Display.

F2 # DAYS – When you press the F2 key from the Retrieve Data Display, you will be prompted to enter the number of days for which data is to be retrieved. You will see the screen display shown in Figure 3-8.

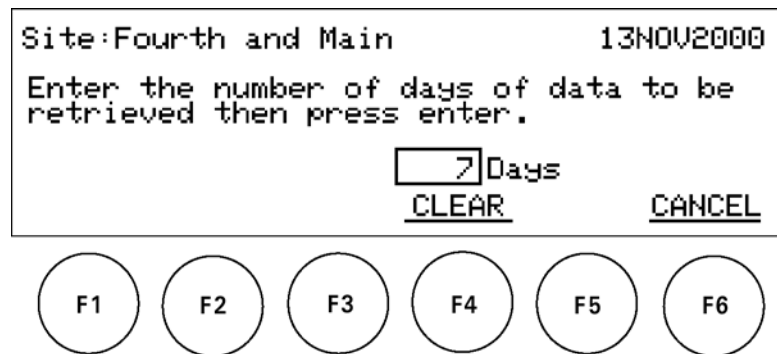

Figure 3-8 Retrieve # Days Display

Use the number keys on the keypad to enter the number of days for which you want data to be retrieved. Press Enter.

To clear the number of days and reset it to zero, press F4 CLEAR. To cancel your entry and return to the previous screen, press F6 CANCEL.

The system will take the current date and retrieve data starting at midnight, including the current day (which is counted as day zero). For example, if the current date was March 11, and you requested to retrieve data for the past 7 days, data retrieval would start at the beginning of March 4 and would include data through March 11. As another example, if you entered zero (0) days, data would be retrieved for the current day, beginning at midnight.

During data collection, the name of the module being interrogated will be displayed, along with a gauge so you can note the progress.

To cancel the data collection process, press F6 CANCEL. When data collection is complete, an audible signal will sound, and you will be returned to the Main Display.

F3 ALL – Pressing the F3 key from the Retrieve Data Display will retrieve all data that has been stored in the modules, up to the current time and date. This process will take some time.

F6 CANCEL – Press the F6 key from the Retrieve Data Display to return to the Main Display.

3.6.2 Data Retrieval Log Display

When you press F2 LOG from the Main Display, the window shown in Figure 3-9 will be displayed.

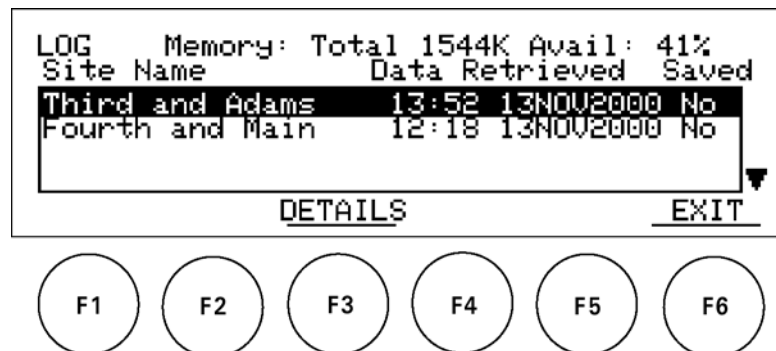

Figure 3-9 Log Display

This display contains historical information on data that has already been retrieved from the site and stored in the Field Wizard. It also includes information about the status of the Field Wizard's storage memory.

The historical data is listed by site name, with the most recently retrieved one listed first. The site name is followed by the time and date the data was retrieved. An indication of the data's handling state is listed under the "Saved" header. When data is first collected, it will have a state of "No." After the data has been transferred to the Master Database on the PC, the state will change to "Yes."

Once you have transferred a site's data to the Master Database in Flowlink, it is eligible to be purged, thus freeing up memory space to collect more data. Note, however, that site data with a handling state of "Yes" will not be purged until the Field Wizard has been connected to a site and data retrieval has been initiated. This allows you to transfer site data to multiple PCs before purging the data.

Use the Up and Down arrow keys to scroll through the list of sites. Once you have highlighted a site, you can view more detailed information for the modules at that site by pressing F3 DETAILS.

F3 DETAILS – When you press F3 DETAILS, a screen similar to the one in Figure 3-10 will be displayed.

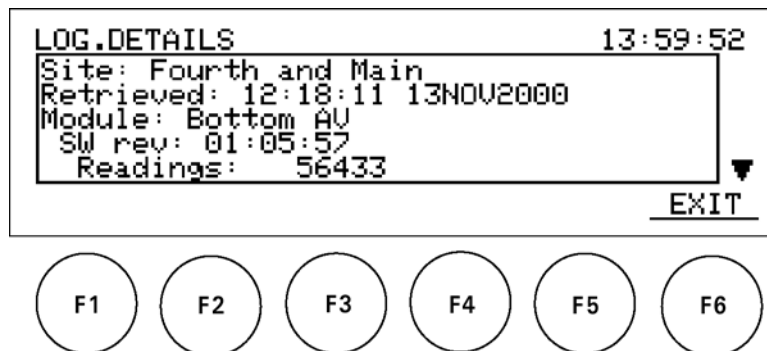

Figure 3-10 Data Log Details Display

The detailed information for a site is contained in a scrolling text window. Use the directional arrow keys to move within the window and view the data.

The information identifies the time and date of the interrogation and lists readings for each module at that particular site.

To exit the display and return to the Log Display, press F6 EXIT.

3.6.3 Site Setup Display

The Site Setup displays shown in Figures 3-11 and 3-13 are accessed by pressing F3 SETUP from the Main Display. One of the Setup displays is for the Field Wizard; the other is for 2100 Series modules in the site's stack.

Press F2 NEXT to move between modules. An indicator (X of X) after the module name will indicate the total number of modules. The Field Wizard itself is considered one of the modules.

Use the Setup displays to adjust the backlighting for the Field Wizard and calibrate sensors and run diagnostics on the 2100 Series modules.

Field Wizard Backlight Mode – When you press F2 NEXT and advance to the Field Wizard module, the Setup display in Figure 3-11 will be shown.

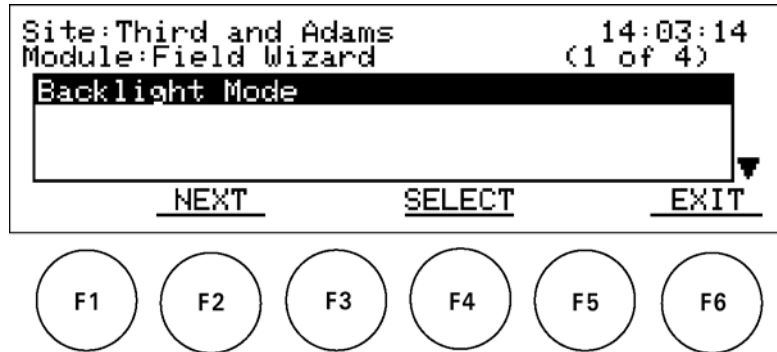

Figure 3-11 Field Wizard Site Setup Display

If you press F2 NEXT, you will advance to the next module's Site Setup display screen. If you press F6 EXIT, you will return to the Data Retrieval Mode Main Display.

Press F4 SELECT to change the backlight mode for the Field Wizard. The following screen will be displayed:

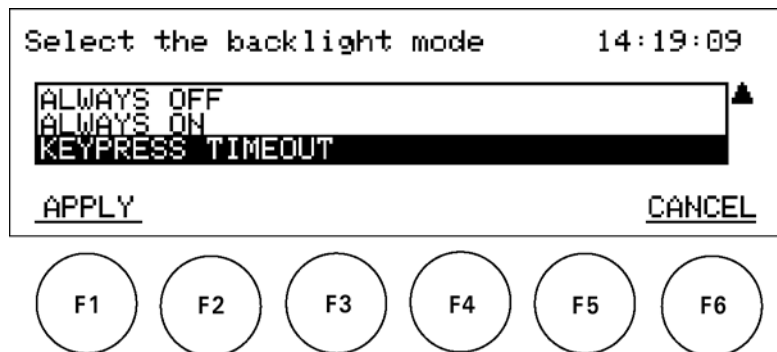

Figure 3-12 Field Wizard Backlight Mode Settings

There are three options for the backlight mode on the Field Wizard. Highlight the desired option and press F1 APPLY to select that option. Press F6 CANCEL to return to the Field Wizard Site Setup display.

ALWAYS OFF - The backlight will always be off.

ALWAYS ON - The backlight will always be on.

KEYPRESS TIMEOUT - After one minute of inactivity, the backlight will turn off until a key is pressed.

2100 Series Site Setup – If you press F2 NEXT and advance to a 2100 Series module, the Setup display shown in Figure 3-13 will appear.

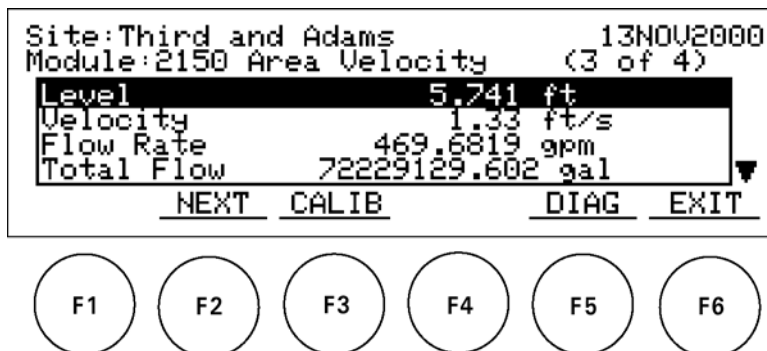

Figure 3-13 Site Setup Display

The Site Setup display is used to calibrate sensors and run diagnostics on sensors. Module sensor information, such as level and flow rate, is presented inside the display window. Use the Up and Down arrow keys to scroll within the window.

Measurement Calibration – Level sensors can be calibrated using the Field Wizard. Before you can calibrate, one valid reading must have been taken so there is a value to calibrate to.

On the Site Setup display, use F2 NEXT to display the module you want to calibrate, then press F3 CALIB. The Level Calibration window for the selected module will appear (Figure 3-14).

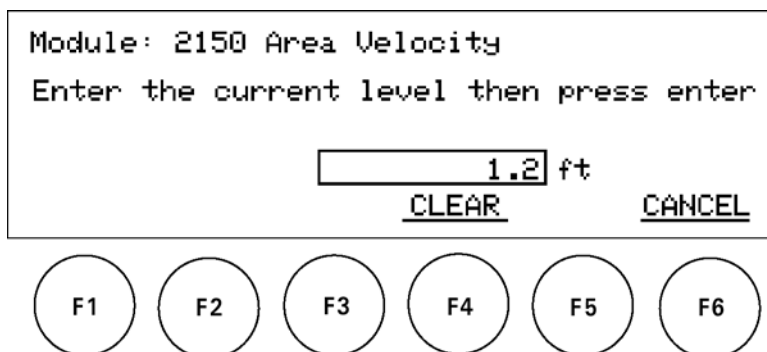

Figure 3-14 Level Calibration Display

The level currently being detected will be displayed. To change the level, use the numeric keys and then press Enter. You will be returned to the Site Setup display. The message “Updating” will appear in the Level field momentarily while the system updates its information.

To clear an entry, press F4 CLEAR. To cancel the process and return to the Site Setup display, press F6 CANCEL.

Sensor Diagnostics – When you press F5 DIAG from the Site Setup display, the diagnostic screen shown in Figure 3-15 will be displayed.

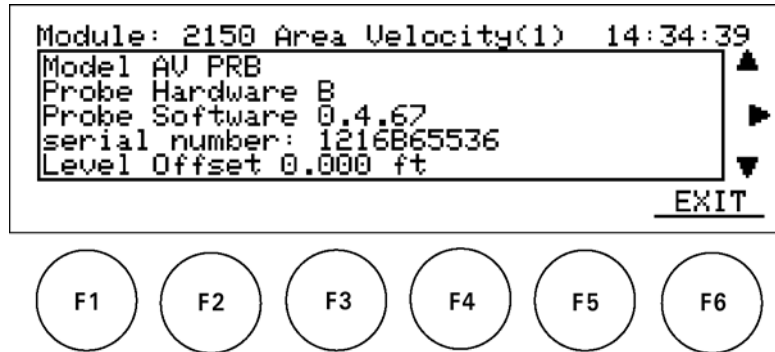

Figure 3-15 Sensor Diagnostics Display

After a momentary delay, during which the Field Wizard requests the report from the 2100 Series module, a screen containing diagnostic results for the selected module’s sensors will appear. Use the four directional arrow keys to scroll through the information.

Once you have viewed the information, press F6 EXIT to exit to the Site Setup display.

3.6.4 Data Display

When you press F4 DATA from the Main Display, the Data screen shown in Figure 3-16 will appear.

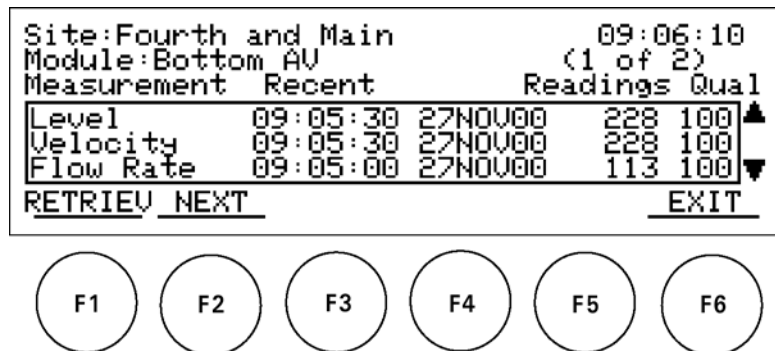

Figure 3-16 Data Display

This display shows information about the data stored inside the currently selected module: the time and date of the most recent reading, total number of readings, and the quality of the readings (percentage that are good). Use the Up and Down arrow keys to scroll through the information.

When multiple 2100 Series modules are present, you can press F2 NEXT to display the information for a different module.

Press F1 RETRIEV to retrieve the data for the displayed module. You will be advanced to the Retrieve Data Display, described in Section 3.6.1.

Press F6 EXIT to return to the Main Display.

3.6.5 Site Information Display

When you press F5 INFO from the Main Display, the Site Information screen is displayed (Figure 3-17).

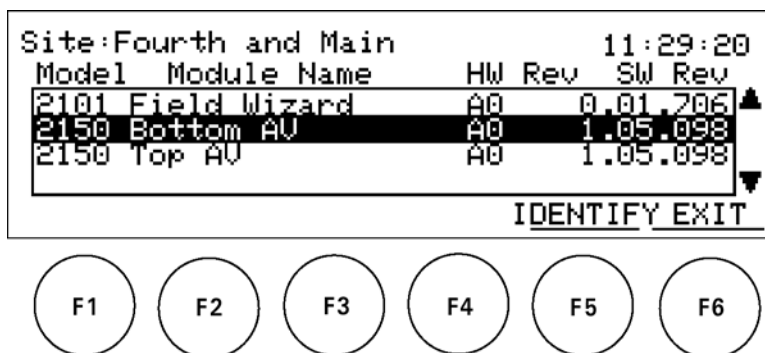

Figure 3-17 Site Information Display

This screen shows information about module models and names, as well as hardware and software revision numbers. Use the Up and Down arrow keys to scroll between the different modules.

To identify a module, highlight it using the arrow keys and then press F5 IDENTIFY. This will cause the LED for that module to light up continuously for a short period of time. If you press F5 IDENTIFY when Field Wizard is highlighted, the system beeps.

Press F6 EXIT to return to the Main Display.

3.7 Standalone Mode

When the Field Wizard is not connected to a site or a PC, it is in standalone mode. The Main Display in standalone mode is shown in Figure 3-18.

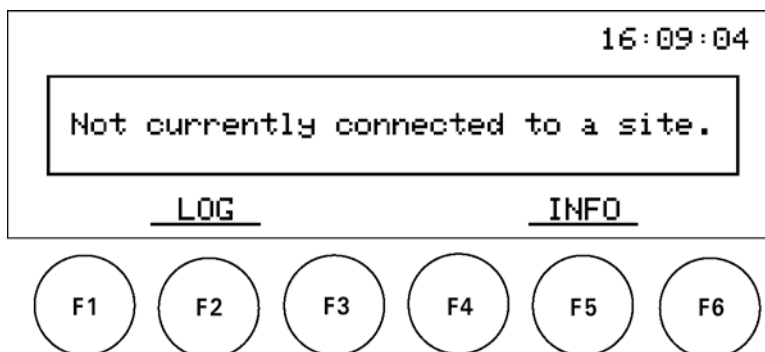

Figure 3-18 Standalone Mode Main Display

In this mode, you can examine the data log stored inside the Field Wizard unit, but will not be able to view or process the actual data.

To view the data retrieval log, press F2 LOG. The display will be similar to that shown in Figure 3-9 and described in Section 3.5.2.

3.7.1 Standalone Information Display

Pressing F5 INFO while in the standalone mode will display the Standalone Information screen (Figure 3-19).

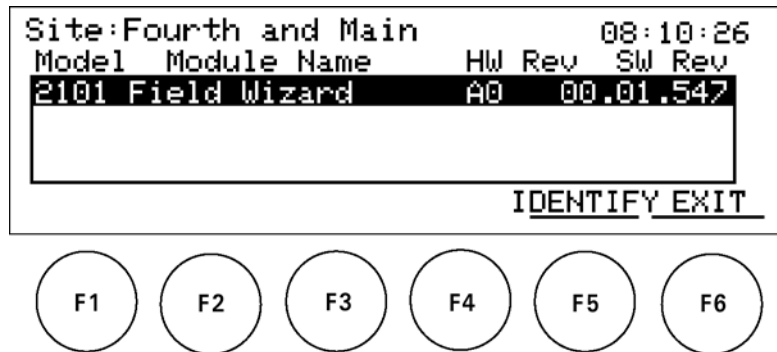

Figure 3-19 Standalone Information Display

This screen is similar to that described in Section 3.5.4, except that it only lists information pertaining to the Field Wizard itself. Because it is not connected to a site, there isn't any module information.

To exit from the Standalone Information Display, press F6 EXIT.

3.8 PC Data Synchronization Mode

When the Field Wizard is connected to a PC, the user interface (keypad) is locked out to prevent any errors while transmitting data to the PC.

In this mode, the Field Wizard's display looks like that shown in Figure 3-20.

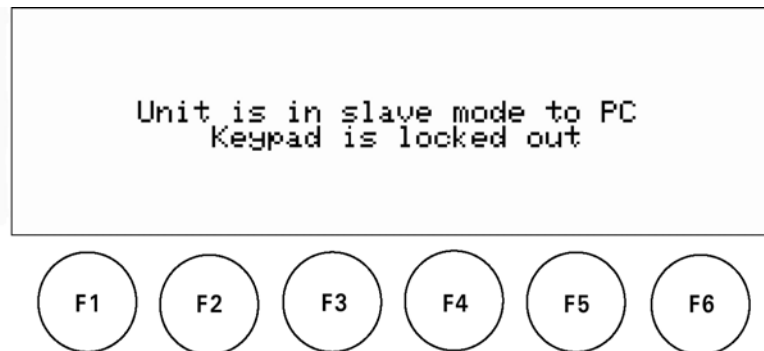

Figure 3-20 PC Data Synchronization Mode Display

The Field Wizard's keypad will not function in this mode, but will return to normal function when the Field Wizard is disconnected from the PC.

2101 Field Wizard

Section 4 Modbus Protocol

Sections 4.1 through 4.5 give an overview of the basic capabilities and operation of Modbus protocol as it applies to Isco 2100 Series flow modules.

For a Glossary of Terms and Common Acronyms, see sections 4.4 and 4.5.

For Modbus technical specifications, turn to section 4.6.

4.1 Introduction

Modbus is a simple command/response mechanism to read from and write to specific memory locations called *registers*. A register is a holding place for a piece of digital information within the equipment. There are three standard protocols for Modbus: Modbus RTU, Modbus TCP/IP, and Modbus ASCII. The Isco 2100 Series devices use Modbus ASCII protocol, the method discussed in this manual. Modbus ASCII has more flexible communication timing requirements. Modbus communication for the Isco 2100 Series provides a standard protocol that can be used to retrieve real-time data from a single module or stack of modules at a site, or multiple sites, over a wide area. The data can be sent to a central computer for display, data collection, or process control.

Modbus implementation is independent of Flowlink and cannot alter the Flowlink-programmed configuration of the module. Modbus cannot be used to retrieve historical data from a module's memory.

Due to the wide variety of configurations that can be made with Modbus, it is impossible to cover every usable application. This section will discuss the overall capabilities and operation of Modbus.

4.2 Operation

There are many standard, third party Modbus drivers and OPC servers that may be used to link a remote Modbus device, such as a 2100 Series module, to SCADA or process control software, such as Wonderware™ or Intellution™. The OPC server communicates with the remote instrumentation and accesses registers. The definition of what information is contained and where (the register number, or address) is decided by the manufacturer (Teledyne Isco).

In a 2100 module, the registers hold, but are not limited to, the current real-time value of the meter's level, velocity, flow, input voltage, temperature, and total flow readings, stored in specified register locations. A list of the 2100 register addresses, and what parameters are held where, is available in section 4.6.

By accessing these registers you can obtain the current value of whatever parameter you desire. The reading(s) can then be displayed or stored wherever you designate as a destination; for example, a process control computer.

 **Note**

Level, flow, velocity, and temperature data is stored in metric units only.

Not all registers are limited to read-only data storage. You can also use some registers for control purposes. For example, by writing a “1” value to register 24 (“Identify Module” register), you will tell a 2100 module to light the LED on the front of the module.

4.2.1 Establishing Communication

There are several different communications protocols supported in the 2100 series that require auto-baud rate detection. Because of this, each time a modbus connection is made, the module uses a polling mechanism to repeatedly send a command until a response is received. It may take up to 20 command retries before the module has identified the baud rate and a response is received.

4.2.2 Module Addressing

When connecting to a site via a Modbus OPC server, you use a dedicated line of communication to that module or stack from the OPC server, which can be a dedicated communications cable (direct connection) or a dedicated phone number (modem).

When you are using a direct connection, you are dedicating a specified COM port on the computer, and that COM port determines the site to which you are connecting.

When you are using a modem, the dedicated line is defined by the site's phone number.

If you connect more than one 2100 Series module at a site, the Modbus OPC server, while using the shared communication line for all of the modules within the network, must have some way to differentiate between the modules. When sending a command to a specific module, the command has an address field. This allows the server software to talk to, as well as control, the specified module, while ignoring other modules in the same stack or site.

Each module capable of Modbus Protocol communication will automatically create its own specific ASCII address within the site, using:

- The model numbers of the modules
- The user-defined module names

4.3 Configurations

A variety of configurations can be made with Modbus, either through direct connection or through a modem.

In the example shown in Figure 4-1, you are direct-connecting a server PC to two individual 2150s through Modbus, using the COM ports on the OPC Server, which are directly connected to the remote 2150s.

Connection to the module is made through the RS-232 communication port on the top of the module.

Note

For low power operation, we recommend connecting the module(s) to the computer using the straight-through cable (Isco part number 60-5314-529), which consumes less power, instead of our standard interrogation cable.

In Figure 4-1, the OPC Server PC must have two COM ports. Modbus requires one COM port each, for direct connection of each 2150.

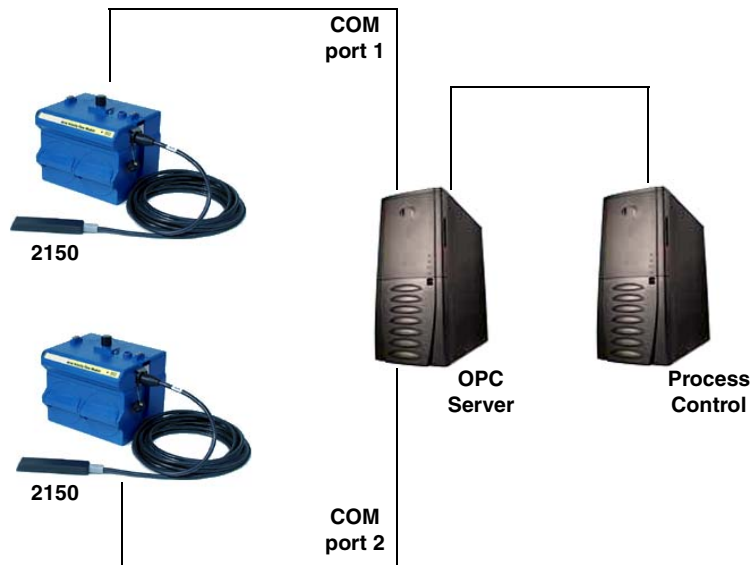

Figure 4-1 Configuration Example (Direct Connection Shown)

The operation sequence for the example above can be summarized in the following steps:

2150:

1. 2150s take readings from probes.
2. 2150s store readings (level, velocity, flow rate, etc.) in their specified registers.

Process Control:

3. The user requests data through Process Control.
4. Process Control asks the OPC server to gather information.

5. OPC connects to the 2150 stack through the cable (direct connection), takes register data from the specified 2150, and populates the OPC server's holding index.
6. Process Control takes data from the OPC server's holding index and gives data to the user.

Note that Process Control can be either manual or automated in this example, and that the OPC server and Process Control may be located physically on the same computer.

4.4 Glossary of Terms

ASCII – Short for American Standard Code for Information Interchange, ASCII is a code that represents English characters with numbers. Most computers represent text with ASCII code, making it possible for one computer or device to share data with another.

2100 modules support Modbus ASCII protocol.

Dedicated Line – A telecommunications path reserved for communication between two specified points and not shared among multiple points.

Modbus Protocol – Modbus Protocol is a messaging structure used to establish master-slave/client server communications between intelligent devices. Modbus is a simple command/response mechanism to read from and write to registers.

OPC – OPC (OLE for Process Control) means open connectivity via open (free for use) standards. It is a series of software standards specifications that fill a need in automation (like printer drivers did for Windows), acting as a translator for data transmission and process control.

The specification defines a standard set of objects, interfaces, and methods for use in process control and manufacturing automation applications to facilitate interoperability. There are hundreds of OPC Data Access servers and clients.

Registers – Registers are locations in memory that have specific data stored for retrieval or are used for control functions. A register is a holding place for a piece of digital information within the equipment. The definition of what is contained and where (the registry number, or address) is decided by the manufacturer (in this case Teledyne Isco).

SCADA – SCADA (Supervisory Control And Data Acquisition) is a computer system for gathering and analyzing real-time data. SCADA systems are used to monitor and control plant operation, or equipment in industries such as telecommunications, water and waste control, energy, oil and gas refining, and transportation.

The SCADA system transfers the information (for example, where a leak has occurred in a pipeline), back to a central site, alerting the home station of the leak, performing necessary analysis and control (such as determining if the leak is critical), and displaying the information in a logical and organized manner.

SCADA systems can be relatively simple, such as one that monitors the environmental conditions of a small office building, or very complex, such as a system that monitors all the activity in a nuclear power plant or a municipal water system.

4.5 Common Acronyms

ASCII – American Standard Code for Information Interchange
DCS – Distributed Control Systems
MTU – Master Terminal Unit
OPC – Object Linking and Embedding (OLE) for Process Control
PLC – Programmable Logic Controller
RTU – Remote Terminal Unit
SCADA – Supervisory Control And Data Acquisition
TCP/IP – Transmission Control Protocol/Internet Protocol

4.6 Register Specifications

All numbers in the Modbus registers are stored most significant byte first. If the polling device has a byte ordering of least significant byte first (an Intel-based PC, for example), the bytes will need to be reversed after they are received.

The Modbus ASCII address is used to index the data by modules.

Modbus ASCII address 1 contains information related to the site. The first register contains a 16-bit integer count of the number of modules that have data to report. The maximum number of modules that can be supported is 4.

Modbus ASCII addresses 2 through the number of modules plus 1 contain data from the individual modules.

The Modbus ASCII addresses will be sorted by the model number, and then by module name, which is entered by the user through Flowlink. This allows the user to control the ordering of the addresses and easily predict what data will be in specific registers.

Every measured parameter has a corresponding status and measurement time that are updated with each measurement.

The maximum number of supported measurements from all modules in the system is 28.

The Modbus registers are assigned within 30 seconds after the 2100 module is powered up. To conserve power for the users who do not use Modbus communications, no Modbus registers will be updated with sensor readings until a Modbus master communicates with the 2100 module.

The register definitions for the Site Information device (Modbus ASCII address 1) are in Table 4-1 below:

Register Number(s)	Name	Data type	Units	Read/Write
1	Number of modules (N) (1-4)	16 bit integer	None	Read
2-20	Site name	38-byte string	None	Read

The register definitions for the individual modules (Modbus ASCII addresses 2-(N+1)) are in Table 4-1 below:

Table 4-2 Modbus ASCII Address 2-(N+1) Register Definitions				
Register Number(s)	Name	Data Type	Units	Read/Write
1-4	Model number	8-byte string	None	Read
5-23	Module name	38-byte string	None	Read
24 ¹	Identify module	16 bit integer	None	Read/Write
25 ²	Take reading flag	16 bit integer	None	Read/Write
26 ³	Update interval	16 bit integer	Seconds	Read/Write
27 ⁴	Active flag 1	16 bit field	None	Read
28	Active flag 2	16 bit field	None	Read
29	Active flag 3	16 bit field	None	Read
30	Active flag 4	16 bit field	None	Read
40,41	Level	4-byte float	Meters	Read
42	Level status code ⁵	16-bit integer		Read
43-52	Level time record	Time ⁶		Read
55,56	Velocity	4-byte float	Meters/second	Read
57	Velocity status code	16-bit integer		Read
58-63	Velocity time record	Time		Read
70,71	Flow	4-byte float	Cubic Meters/sec	Read
72	Flow status code	16-bit integer		Read
73-78	Flow time record	Time		Read
85,86	Flow 1	4-byte float	Cubic Meters/sec	Read
87	Flow 1 status code	16-bit integer		Read
88-93	Flow 1 time record	Time		Read
100,101	Volume	4-byte float	Cubic Meters	Read
102	Volume status code	16-bit integer		Read
103-108	Volume time record	Time		Read
115,116	Volume 1	4-byte float	Cubic Meters	Read

Table 4-2 Modbus ASCII Address 2-(N+1) Register Definitions (Continued)

Register Number(s)	Name	Data Type	Units	Read/Write
<p>(1) A write to the Identify module register will cause the module to perform the identify operation which may be a steady LED for a few seconds or a beep in the Field Wizard.</p> <p>(2) Setting the Take Reading flag to 1 will cause the module to update the registers with current data readings. It will be set to zero when the readings have all been updated. This may be used to initiate readings and poll for when they are ready to be read. It may take up to 50 seconds to update all the readings, depending upon the flow conditions. Setting the Take Reading flag to 2 causes an automatic, 15 second update of readings when a Modbus master is polling the 2100.</p> <p>(3) The Update Interval specifies an interval in seconds that the registers are automatically updated. It defaults to zero, which indicates that no automatic updating will occur.</p> <p>(4) The Active Flag (1-4) bit fields specify what fields/registers are active in the list. This provides support for a maximum of 64 fields. For example, if bit 0 of register 27 is set, the Level (registers 40,41) is active. If bit 1 of register 27 is set, then the Velocity (registers 55,56) is active. If bit 0 of register 28 is set, the Analog channel 7 (registers 265,266) is active.</p> <p>(5) A non-zero status code indicates a measurement problem.</p> <p>(6) Time is represented in a series of registers: Order is from lowest address to highest - Seconds (0-59), Minutes (0-59), Hours (0-23), Days (1-31), Month (1-12) and Year (1977-2099).</p>				
117	Volume 1 status code	16-bit integer		Read
118-123	Volume 1 time record	Time		Read
130,131	Voltage	4-byte float	Volts	Read
132	Voltage status code	16-bit integer		Read
133-138	Voltage time record	Time		Read
145,146	Temperature	4-byte float	Degrees Celsius	Read
147	Temperature status code	16-bit integer		Read
148-153	Temperature time record	Time		Read
160,161	Internal Temp	4-byte float	Degrees Celsius	Read
162	Internal Temp status code	16-bit integer		Read
163-168	Internal Temp time record	Time		Read
175,176	Analog channel 1	4-byte float	0-100 percent	Read
177	Analog channel 1 status code	16-bit integer		Read
178-183	Analog channel 1 time record	Time		Read
190,191	Analog channel 2	4-byte float	0-100 percent	Read
192	Analog channel 2 status code	16-bit integer		Read
193-198	Analog channel 2 time Record	Time		Read
205,206	Analog channel 3	4-byte float	0-100 percent	Read
207	Analog channel 3 status code	16-bit integer		Read
208-213	Analog channel 3 time record	Time		Read
220,221	Analog channel 4	4-byte float	0-100 percent	Read
222	Analog channel 4 status code	16-bit integer		Read
223-228	Analog channel 4 time record	Time		Read
235,236	Analog channel 5	4-byte float	0-100 percent	Read
237	Analog channel 5 status code	16-bit integer		Read

Table 4-2 Modbus ASCII Address 2-(N+1) Register Definitions (Continued)

Register Number(s)	Name	Data Type	Units	Read/Write
238-243	Analog channel 5 time record	Time		Read
250,251	Analog channel 6	4-byte float	0-100 percent	Read
252	Analog channel 6 status code	16-bit integer		Read
253-258	Analog channel 6 time record	Time		Read
265,266	Analog channel 7	4-byte float	0-100 percent	Read
267	Analog channel 7 status code	16-bit integer		Read
268-273	Analog channel 7 time record	Time		Read
280,281	Analog channel 8	4-byte float	0-100 percent	Read
282	Analog channel 8 status code	16-bit integer		Read
283-288	Analog channel 8 time record	Time		Read

Table 4-3 Measurement Parameters by Model Number*

2103, 2103C	2108	2110	2150, 2151
Voltage	Analog channel 1	Level	Level
	Analog channel 2	Flow	Velocity
	Analog channel 3	Volume	Flow
		Voltage	Flow 1
		Temperature	Volume
			Volume 1
			Voltage
			Temperature
*Subject to change.			

2101 Field Wizard

Section 5 Maintenance

5.1 Maintenance Overview

This section explains the maintenance requirements of the 2101 Field Wizard.

The Field Wizard is designed to perform reliably in adverse conditions with a minimal amount of routine service requirements. To keep your system working properly, you should check the desiccant and channel conditions at regular intervals.

Maintenance intervals are affected by many variables. Humidity levels obviously affect the service life of the desiccant, and the amount of debris in the stream can drastically alter the channel conditions.

As a guide, for a basic system installed in an environment with moderate humidity levels, the maintenance interval should not exceed three months. A basic system is defined as:

- a single 2100 Series Module,
- powered by a fresh pair of alkaline lantern batteries,
- recording readings at the default intervals of 15 minutes.

Experience is often the best tool to use when establishing minimum maintenance intervals for your system. Until you have gained an understanding of the A-V Module's operation under differing environmental conditions, a weekly maintenance interval is recommended.

5.1.1 Cleaning

The Field Wizard case may be cleaned using a soft cloth and a mild detergent. Do not use an abrasive cleanser, or you might scratch the surface of the case. Be particularly careful when cleaning the display screen; scratches will make it difficult to read the display.

Before cleaning, make sure that all the protective connector caps are in place to avoid damage to any of the connectors. You should also ensure that no water or cleanser enters the desiccant unit.

5.2 Maintenance Kit

Teledyne Isco, Inc.
Customer Service Dept.
P.O. Box 82531
Lincoln, NE 68501 USA
Phone: (800) 228-4373
(402) 464-0231
FAX: (402) 465-3022
E-mail: info@isco.com

Some of the parts mentioned in the *Maintenance* section of this manual are available in a maintenance kit.

Kit number 60-2009-001 contains O-rings for the connectors and desiccant cartridge, a desiccant assembly, and a 1.5 pound container of silica gel desiccant.

You can order the kit by calling Teledyne Isco's Customer Service Department.

5.3 Desiccant

5.3.1 Replacing the Desiccant: 2101

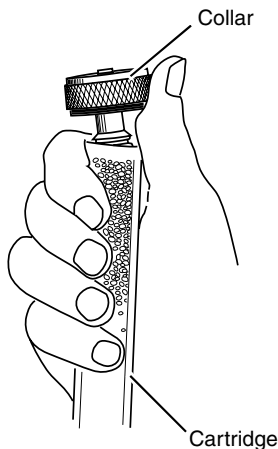

5.3.2 Reactivating the Desiccant

Silica gel

The Field Wizard uses desiccant to protect the internal components from moisture damage. The cartridge is filled with indicating silica gel that is blue or yellow when dry. As the desiccant becomes saturated, the color changes from blue to pink, or from yellow to green. Replace the desiccant before the entire length of the cartridge turns pink or green.

The desiccant is contained in a cartridge located on the left side of the Field Wizard. To remove the cartridge, unscrew the collar and slide the cartridge out of the Field Wizard. The clear tube reveals the silica gel desiccant inside.

To replace the silica gel desiccant:

1. Hold the cartridge upright with the collar at the top.
2. As shown in the margin, push the collar off the cartridge.
3. Empty the saturated silica gel beads or granules.
4. Fill the tube with new (Isco P/N 099-0011-03) or reactivated (see section 4.3.2) silica gel desiccant.
5. Press the collar onto the tube.
6. Slide the cartridge into the Field Wizard. Tighten the collar to seal the cartridge in place.

Silica gel beads and granules of desiccant can be reactivated.

 **CAUTION**

Desiccant may produce irritating fumes when heated. Observe the following precautions:

- Use a vented oven in a well-ventilated room.
- Do not remain in the room while the regeneration is taking place.
- Use the recommended temperature. Avoid heating the desiccant at higher than recommended temperatures.

There have been reports of irritating fumes coming from the desiccant during reactivation. While our attempts to duplicate the problem have been unsuccessful, we still urge you to use caution. Material Safety Data Sheets are in the back of this manual.

The desiccant's ability to remove moisture may lessen with each saturation/reactivation cycle, resulting in a need for more frequent service. After several cycles, the desiccant may no longer be effective as it saturates too quickly. At this point, replace the desiccant.

To reactivate the silica gel desiccant, pour the spent desiccant into a heat resistant container. Never heat the cartridge assembly; it will melt. Heat the silica gel in a *vented convection*

oven at 212° to 350°F (100° to 175°C) for two to three hours, or until the blue or yellow color returns. Allow the desiccant to cool and store it in an airtight container until ready for use.

5.4 Hydrophobic Filter

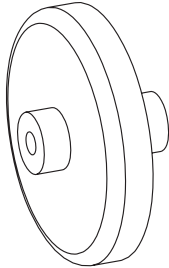

If the Field Wizard module is submerged, a hydrophobic filter prevents water from entering the desiccant cartridge. Any amount of water will plug the filter and it must be replaced so the case will be reliably ventilated. Ventilation is needed to equalize pressure within the Field Wizard to prevent the keypad label from warping.

To remove the hydrophobic filter, grasp the filter and pull it from the desiccant cartridge collar. The filter is only held in place by its friction fitting; rocking it back and forth while pulling may help. Firmly press the replacement filter (Isco P/N 60-2005-003) in place.

If the hydrophobic filter frequently requires replacement, you should consider relocating the modules so that they are better protected. Alternatively, replace the existing hydrophobic filter with the reference extension accessory package included with your unit. Follow the instructions above to remove and replace the filter. Locate the other end of the tubing in a dry location and secure it.

5.5 How to Obtain Service

Teledyne Isco, Inc.
Technical Service Dept.
P.O. Box 82531
Lincoln, NE 68501 USA

Phone: (800) 228-4373
(402) 464-0231
FAX: (402) 465-3085

E-mail: service@isco.com

The internal components of the Field Wizard are not user-serviceable. The case is completely sealed to protect the internal components. To repair the unit, the case must be broken open and replaced. If you think your module requires repair, contact Teledyne Isco's Technical Service Department.

Corresponding with a Teledyne Isco Technical Service Representative can often resolve the problem without the need to return the item. If the difficulty cannot be resolved you will be issued a Return Authorization Number (RAN) and information on returning it to the factory.

2101 Field Wizard

Appendix A Replacement Parts

A.1 Replacement Parts

Replacement parts are called out in the following illustration. Refer to the call-out in the adjacent list to determine the part number for the item.

Replacement parts can be purchased by contacting Teledyne Isco's Customer Service Department.

Teledyne Isco, Inc.

Customer Service Department

P.O. Box 82531

Lincoln, NE 68501 USA

Phone: (800) 228-4373

(402) 464-0231

FAX: (402) 465-3022

E-mail: info@isco.com

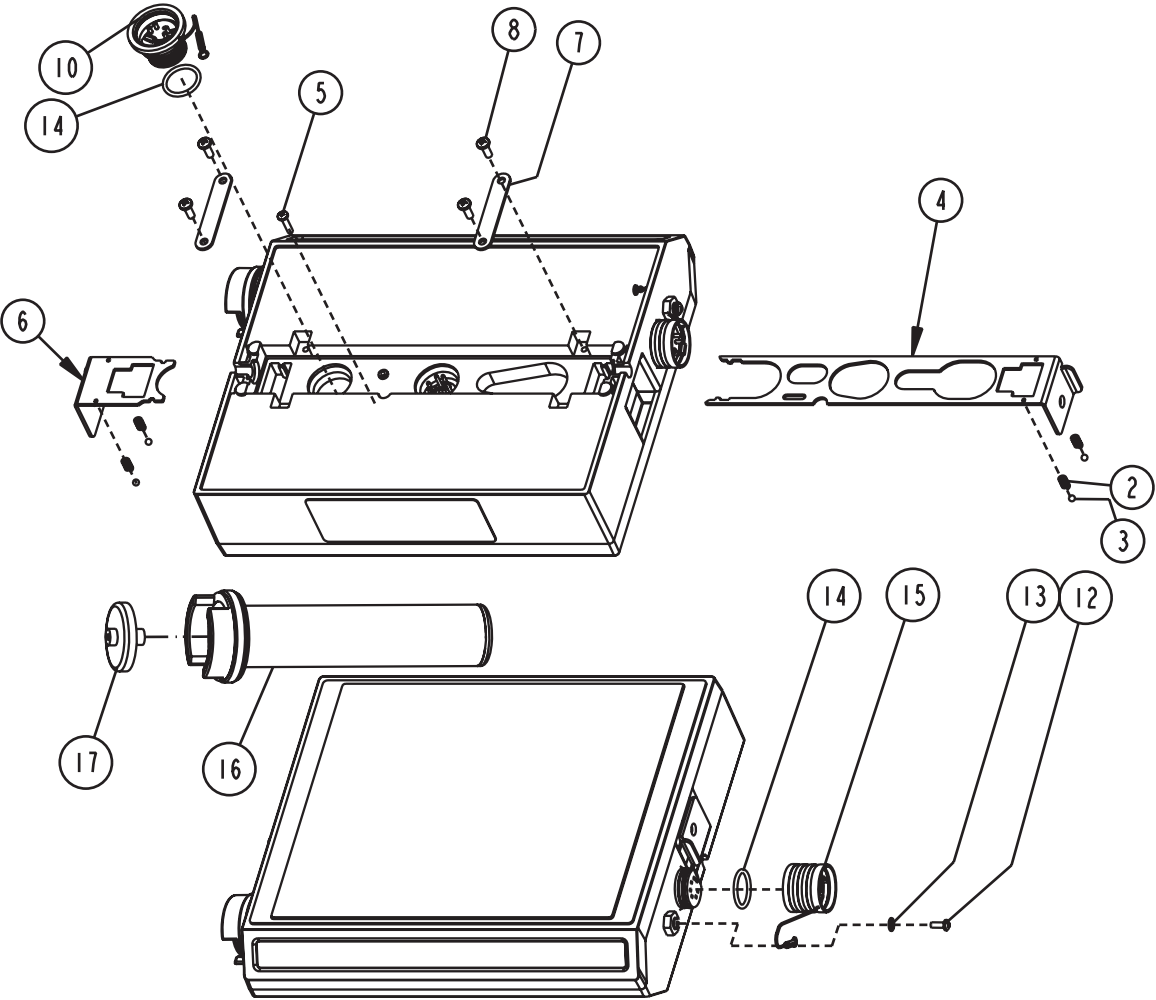

602002050

REPLACEMENT PARTS LIST

SHEET: 2 OF 2

Isco, Inc.

REV: D

DATE: 00330

ITEM NO.	PART NUMBER	DESCRIPTION
2	203011602	SPRING, .022 Ø WIRE, .31 FREE LGTH
3	201900102	BALL, .125 Ø, S'STEEL
4	692003190	LARGE LATCH
5	231611108	SCREW, PAN HEAD, #4X1/2
6	692003189	SMALL LATCH
7	602003022	LATCH HOLD
8	231311206	SCREW, SELF TAPPING, #6-32, S'STEEL
9	231014322	SCREW, PAN HEAD, 4-40x3/8, S'STEEL
10	602004013	P ASSY, FEM CONN (includes item 14)
12	231514305	SCREW, PAN HEAD, 4-40x5/16, S'STEEL
13	233210400	LOCK WASHER, #4 INT. LOCK, S'STEEL
14	202100669	O RING, .650 ID, .079 CROSS SECTION SILICONE
15	602004069	CAP ASSY, MALE CONNECTOR (includes item 14)
16	602004060	DESICCANT ASSY (INCLUDES ITEM 17)
17	602005003	INLINE AIR FILTER FOR 25mm TUBING

NOTE: 1. For current prices and quotations on parts, contact Isco Service Department.
2. This list is subject to change without notice.

2101 Field Wizard

Appendix B Accessories

B.1 How to Order

Accessories can be purchased by contacting Isco's Customer Service Department.

Teledyne Isco, Inc.
Customer Service Dept.
P.O. Box 82531
Lincoln, NE 68501 USA

Phone: (800) 228-4373

(402) 464-0231

FAX: (402) 465-3022

E-mail: info@isco.com

B.2 General Accessories

Field Wizard Instruction Manual	60-2003-155
Flowlink for Windows Software	69-2543-144
Communication Cable	60-2004-046
AC Adapter.	60-2004-057
Field Wizard Maintenance Kit	60-2009-001
Silica Gel Desiccant	099-0011-03
Hydrophobic Filter.	60-2005-003
Tubing, 10' Silicone	60-2003-104

2101 Field Wizard

Appendix C Material Safety Data Sheets

C.1 Overview

This appendix to the manual provides Material Safety Data Sheets for the desiccant used by the 2101 Field Wizard and 2191 Battery Module.

Isco cannot guarantee the accuracy of the data. Specific questions regarding the use and handling of the products should be directed to the manufacturer listed on the MSDS.



MATERIAL SAFETY DATA SHEET

Effective Date March 8, 2005
MSDS Number M163

Section 1 – Product and Company Information

Product Name: Silica gel, indicating, yellow

Product Use: Desiccant, absorbent

Grades: Silica gel, indicating

Synonyms: Amorphous silica gel, SiO₂, silicon dioxide (amorphous)

Company: Multisorb Technologies, Inc.

Street Address: 325 Harlem Road

City, State, Zip, Country: Buffalo, NY 14224-1893 USA

Telephone Number: (716) 824 8900 [USA] Monday - Friday (8:00 - 5:00 EDT)

Fax Number: (716) 824 4091 [USA]

Website / E-Mail : multisorb.com

Section 2 – Composition / Information on Ingredients

Component Name	CAS Number	% by Weight
Synthetic amorphous silica gel (SiO ₂)	112926-00-8	100
Phenolphthalein	77-09-08	100 ppm

While this material is not classified, this MSDS contains valuable information critical to the safe handling and proper use of this product. This MSDS should be retained and available for employees and other users of this product.

Section 3 – Hazard Identification

Emergency Overview: A yellow bead or granular material that poses little or no immediate hazard. This material is not combustible.

Potential Health Effects:

Eyes: Dust and or product may cause eye discomfort and irritation seen as tearing and reddening.

Skin: The product dust may cause drying of the skin. Silica gel may get hot enough to burn skin when it adsorbs moisture rapidly. Use an excess of water to cool the silica gel.

Ingestion: Material is not toxic and will pass through the body normally.

Inhalation: Slight irritation is possible but none is expected.

Medical Effects Generally Aggravated by Exposure: Respiratory ailments.

Chronic Effects/Carcinogenicity: May cause eye, skin and mucous membrane irritation and drying.

Section 4 – First Aid Measures

- Eyes:** Rinse the eyes well with water while lifting the eye lids. If irritation persists, consult a physician.
- Skin:** Wash affected area with soap and water.
- Ingestion:** Ingestion is unlikely, this material will pass through the body normally.
- Inhalation:** Remove the affected person to fresh air and get medical attention if necessary.
- Notes to Physician:** Not applicable

Section 5 – Fire Fighting Measures

- Flammable Properties:** Not flammable
- Flash Point:** Not applicable **Method:** Not applicable
- Flammable Limits:** Not flammable
- Lower Flammability Limit:** Not applicable
- Upper Flammability Limit:** Not applicable
- Autoignition Temperature:** Not applicable
- Hazardous Combustion Products:** Not applicable
- Extinguishing Media:** Use extinguishing media that is appropriate for the surrounding fire. Silica gel is not combustible.
- Fire Fighting Instructions:** Not combustible
- Unusual Fire and Explosion Hazards:** None

Section 6 – Accidental Release Measures

- Spill:** Sweep or vacuum up and place the spilled material in a waste disposal container. Avoid raising dust. Wash with soap and water after handling.

Section 7 – Handling and Storage

- Handling:** Avoid raising dust and minimize the contact between worker and the material. Practice good hygienic work practices.
- Storage:** Store in a cool, dry location. Keep in sealed containers away from moisture. The silica gel will readily adsorb moisture.

Section 8 – Exposure Controls/Personal Protection

- Engineering Controls:** Use exhaust ventilation to keep the airborne concentrations below the exposure limits.
- Respiratory Protection:** Use NIOSH approved respirator when the air quality levels exceed the TLV's.
- Skin Protection:** Light gloves will protect against abrasion and drying of the skin.
- Eye Protection:** Safety glasses.

Component Name	Exposure Limits		
	OSHA PEL	ACGIH TLV	Other Recommended Limits
Silica gel	TWA 20 mppcf (80 mg / m ³ % SiO ₂)	TWA 10 mg / m ³	NIOSH REL TWA 6 mg / m ³ IDLH 3000 mg / m ³
Phenolphthalein	Not Applicable	Not Applicable	Not Applicable

Section 9 – Physical and Chemical Properties

- | | |
|---|---|
| Appearance: Yellow beads or granules | Vapor Density: Not applicable |
| Odor: None | Boiling Point: 4046° F (2230° C) |
| Physical State: Solid bead | Melting Point: 3110° F (1710° C) |
| PH: Not applicable | Solubility: Insoluble in water |
| Vapor Pressure: Not applicable | Specific Gravity: 2.1 |

Section 10 – Stability and Reactivity

- Stability:** Stable
- Conditions to avoid:** Moisture and high humidity environments.
- Incompatibility:** Water, fluorine, oxygen difluoride, chlorine trifluoride
- Hazardous Decomposition Products:** None
- Hazardous Polymerization:** Will not occur

Section 11 – Toxicological Information

This product and its components are not listed on the NTP or OSHA Carcinogen lists.

Animal Toxicology Tests for DOT Hazard classification
(Tests Conducted on finely ground silica gel)
1 - hour LC₅₀ (rat) > 2 mg / l
48 - hour oral LD₅₀ (rat) est. > 31,600 mg / kg
48 - hour dermal LD₅₀ (rabbit) est. > 2,000 mg / kg
Considered an ocular irritant

Human Toxicology Silica gel is a synthetic amorphous silica not to be confused with crystalline silica. Epidemiological studies indicate low potential for adverse health effects. In the activated form, silica gel acts as a desiccant and can cause a drying irritation of the mucous membranes and skin in cases of severe exposure. Multisorb Technologies Inc. knows of no medical conditions that are abnormally aggravated by exposure to silica gel. The primary route of entry is inhalation of dust.

Section 12 – Ecological Information

Not known to have any adverse effect on the aquatic environment. Silica gel is insoluble and non-toxic.

Section 13 – Disposal Information

Disposal Information If this product as supplied becomes a waste, it does not meet the criteria of a hazardous waste as defined under the Resource Conservation and Recovery Act (RCRA) 40 CFR 261. Materials of a hazardous nature that contact the product during normal use may be retained on the product. The user of the product must identify the hazards associated with the retained material in order to assess the waste disposal options. Dispose according to federal, state and local regulations.

Section 14 – Transportation Information

U.S. Department of Transportation Shipping Name: Not classified as a hazardous material. Not regulated.

Section 15 – Regulatory Information (Not meant to be all inclusive - selected regulations represented)

TSCA Listed: Yes

DSL/NDSL (Canadian) Listed: Yes

OSHA: TWA 20 mppcf (80 mg / m³ % SiO₂) for Silica gel

NIOSH: REL TWA 6 mg / m³ IDLH 3,000 mg / m³ for silica gel
Animal tests conducted in 1976 - 1978. 18 month exposure at 15 mg / m³ showed silica deposition in respiratory macrophages and lymph nodes, minimum lung impairment, no silicosis.

ACGIH: TLV - 10 mg / m³ for Silica gel

DOT: Not classified as a hazardous material.

Section 16 – Other Information

HMIS – Hazardous Materials Identification System

HMIS Rating	
Health	0
Flammability	0
Reactivity	0

0 - minimal hazard, 1 - slight hazard, 2 - moderate hazard, 3 - serious hazard, 4 - severe hazard

This MSDS was prepared by: George E. Mckedy
Senior Applications Development Specialist
Multisorb Technologies, Inc.

This data and recommendations presented in this data sheet concerning the use of our product and the materials contained therein are believed to be correct but does not purport to be all inclusive and shall be used only as a guide. However, the customer should determine the suitability of such materials for his purpose before adopting them on a commercial scale. Since the use of our products is beyond our control, no guarantee, expressed or implied, is made and no responsibility assumed for the use of this material or the results to be obtained therefrom. Information on this form is furnished for the purpose of compliance with Government Health and Safety Regulations and shall not be used for any other purposes. Moreover, the recommendations contained in this data sheet are not to be construed as a license to operate under, or a recommendation to infringe, any existing patents, nor should they be confused with state, municipal or insurance requirements, or with national safety codes.

产品中有毒有害物质或元素的名称及含量

Name and amount of Hazardous Substances or Elements in the product

部件名称 Component Name	有毒有害物质或元素 Hazardous Substances or Elements					
	铅 (Pb)	汞 (Hg)	镉 (Cd)	六价铬 (Cr(VI))	多溴联苯 (PBB)	多溴二联苯 (PBDE)
线路板 Circuit Board	X	O	O	O	O	O
显示 Display	X	O	O	O	O	O
接线 Wiring	O	O	O	O	X	O
小键盘 Keypad	O	O	O	O	X	O

产品中有毒有害物质或元素的名称及含量：Name and amount of Hazardous Substances or Elements in the product

O: 表示该有毒有害物质在该部件所有均质材料中的含量均在ST/ 标准规定的限量要求以下。

O: Represent the concentration of the hazardous substance in this component's any homogeneous pieces is lower than the ST/ standard limitation.

X：表示该有毒有害物质至少在该部件的某一均质材料中的含量超出ST/ 标准规定的限量要求。

(企业可在此处，根据实际情况对上表中打“X”的技术原因进行进一步说明。)

X: Represent the concentration of the hazardous substance in this component's at least one homogeneous piece is higher than the ST/ standard limitation.

(Manufacturer may give technical reasons to the “X”marks)

环保使用期由经验确定。

The Environmentally Friendly Use Period (EFUP) was determined through experience.

生产日期被编码在系列号码中。前三位数字为生产年(207 代表 2007 年)。随后的一个字母代表月份：

A 为一月，B 为二月，等等。

The date of Manufacture is in code within the serial number. The first three numbers are the year of manufacture (207 is year 2007) followed by a letter for the month. "A" is January, "B" is February and so on.

DECLARATION OF CONFORMITY

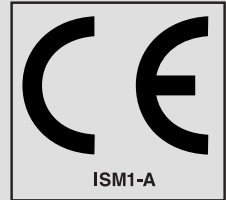

Application of Council Directive: 89/336/EEC – The EMC Directive
73/23/EEC – The Low Voltage Directive

Manufacturer's Name: Teledyne Isco, Inc.
Manufacturer's Address: 4700 Superior, Lincoln, Nebraska 68504 USA
Mailing Address: P.O. Box 82531, Lincoln, NE 68501

Equipment Type/Environment: Laboratory Equipment for Light Industrial/Commercial Environments

Trade Name/Model No: 2101 Field Wizard Module

Year of Issue: 2001

Standards to which Conformity is Declared: EN 61326-1998 EMC Requirements for Electrical Equipment for Measurement, Control, and Laboratory Use
EN 61010-1 Safety Requirements for Electrical Equipment for Measurement, Control and Laboratory use.

Standard	Description	Severity Applied	Performance Criteria
EN61000-4-2	Electrostatic Discharge	Level 2 - 4kV contact discharge Level 3 - 8kV air discharge	B B
EN61000-4-3	Radiated RF Immunity	80 MHz to 1000MHz 80% AM at 1kHz Level 1 – 10V/m	B
EN61000-4-4	Electrical Fast Transient	Level 1 – 1kV on I/O lines	B
EN61000-4-5	Surge on I/O Lines	1kV common mode, 0.5KV differential mode	B
EN61000-4-6	Conducted RF on I/O lines	150 kHz to 80 MHz, 3V rms, 80% modulated	B
CISPR11/ EN 55011	RF Emissions	Group 1, Class A Industrial, Scientific, and Medical Equipment	

We, the undersigned, hereby declare that the design of the equipment specified above conforms to the above Directive(s) and Standards as of July 1, 2001.

William Foster
USA Representative



William Foster
Director of Engineering
Teledyne Isco, Inc.
4700 Superior Street
Lincoln, Nebraska 68504

Phone: (402) 464-0231
Fax: (402) 464-4543

60-2002-157
Rev A

DECLARATION OF CONFORMITY

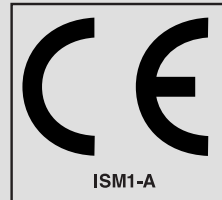

Application of Council Directive: 89/336/EEC – The EMC Directive
73/23/EEC – The Low Voltage Directive

Manufacturer's Name: Teledyne Isco, Inc.
Manufacturer's Address: 4700 Superior, Lincoln, Nebraska 68504 USA
Mailing Address: P.O. Box 82531, Lincoln, NE 68501

Equipment Type/Environment: Laboratory Equipment for Light Industrial/Commercial Environments

Trade Name/Model No: 2191 Battery Module

Year of Issue: 2001

Standards to which Conformity is Declared: EN 61326-1998 EMC Requirements for Electrical Equipment for Measurement, Control, and Laboratory Use
EN 61010-1 Safety Requirements for Electrical Equipment for Measurement, Control and Laboratory use.

Standard	Description	Severity Applied	Performance Criteria
EN61000-4-2	Electrostatic Discharge	Level 2 - 4kV contact discharge Level 3 - 8kV air discharge	B B
EN61000-4-3	Radiated RF Immunity	80 MHz to 1000MHz 80% AM at 1kHz Level 1 – 10V/m	B
EN61000-4-4	Electrical Fast Transient	Level 1 – 1kV on I/O lines	B
EN61000-4-5	Surge on I/O Lines	1kV common mode, 0.5KV differential mode	B
EN61000-4-6	Conducted RF on I/O lines	150 kHz to 80 MHz, 3V rms, 80% modulated	B
CISPR11/ EN 55011	RF Emissions	Group 1, Class A Industrial, Scientific, and Medical Equipment	

We, the undersigned, hereby declare that the design of the equipment specified above conforms to the above Directive(s) and Standards as of July 1, 2001.

William Foster
USA Representative



William Foster
Director of Engineering
Teledyne Isco, Inc.
4700 Superior Street
Lincoln, Nebraska 68504

Phone: (402) 464-0231
Fax: (402) 464-4543

60-2002-158
Rev A

Teledyne Isco One Year Limited Factory Service Warranty *

Teledyne Isco warrants covered products against failure due to faulty parts or workmanship for a period of one year (365 days) from their shipping date, or from the date of installation by an authorized Teledyne Isco Service Engineer, as may be appropriate.

During the warranty period, repairs, replacements, and labor shall be provided at no charge. Teledyne Isco's liability is strictly limited to repair and/or replacement, at Teledyne Isco's sole discretion.

Failure of expendable items (e.g., charts, ribbon, tubing, lamps, glassware, seals, filters, fittings, and wetted parts of valves), or from normal wear, accident, misuse, corrosion, or lack of proper maintenance, is not covered. Teledyne Isco assumes no liability for any consequential damages.

This warranty does not cover loss, damage, or defects resulting from transportation between the customer's facility and the repair facility.

Teledyne Isco specifically disclaims any warranty of merchantability or fitness for a particular purpose.

This warranty applies only to products sold under the Teledyne Isco trademark and is made in lieu of any other warranty, written or expressed.

No items may be returned for warranty service without a return authorization number issued from Teledyne Isco.

The warrantor is Teledyne Isco, Inc.
4700 Superior, Lincoln, NE 68504, U.S.A.

* This warranty applies to the USA and countries where Teledyne Isco Inc. does not have an authorized dealer. Customers in countries outside the USA, where Teledyne Isco has an authorized dealer, should contact their Teledyne Isco dealer for warranty service.

In the event of instrument problems, always contact the Teledyne Isco Service Department, as problems can often be diagnosed and corrected without requiring an on-site visit. In the U.S.A., contact Teledyne Isco Service at the numbers listed below. International customers should contact their local Teledyne Isco agent or Teledyne Isco International Customer Service.

Return Authorization

A return authorization number must be issued prior to shipping. Following authorization, Teledyne Isco will pay for surface transportation (excluding packing/crating) both ways for 30 days from the beginning of the warranty period. After 30 days, expense for warranty shipments will be the responsibility of the customer.

Shipping Address: Teledyne Isco, Inc. - Attention Repair Service
4700 Superior Street
Lincoln NE 68504 USA

Mailing address: Teledyne Isco, Inc.
PO Box 82531
Lincoln NE 68501 USA

Phone: Repair service: (800)775-2965 (lab instruments)
(800)228-4373 (samplers & flow meters)
Sales & General Information (800)228-4373 (USA & Canada)

Fax: (402) 465-3001

Email: iscoservice@teledyne.com **Web site:** www.isco.com



