

2151P Area Velocity Flow System

Installation and Operation Guide



Part #69-2003-247 of Assembly #60-2004-230
Copyright © 2002. All rights reserved, Teledyne Isco, Inc.
Revision T, October 22, 2008

Foreword

This instruction manual is designed to help you gain a thorough understanding of the operation of the equipment. Teledyne Isco recommends that you read this manual completely before placing the equipment in service.

Although Teledyne Isco designs reliability into all equipment, there is always the possibility of a malfunction. This manual may help in diagnosing and repairing the malfunction.

If the problem persists, call or e-mail the Teledyne Isco Technical Service Department for assistance. Simple difficulties can often be diagnosed over the phone.

If it is necessary to return the equipment to the factory for service, please follow the shipping instructions provided by the Customer Service Department, including the use of the **Return Authorization Number** specified. **Be sure to include a note describing the malfunction.** This will aid in the prompt repair and return of the equipment.

Teledyne Isco welcomes suggestions that would improve the information presented in this manual or enhance the operation of the equipment itself.

Teledyne Isco is continually improving its products and reserves the right to change product specifications, replacement parts, schematics, and instructions without notice.

Contact Information

Customer Service

Phone: (800) 228-4373 (USA, Canada, Mexico)
(402) 464-0231 (Outside North America)
Fax: (402) 465-3022
Email: IscoCSR@teledyne.com

Technical Service

Phone: (800) 775-2965 (Analytical)
(800) 228-4373 (Samplers and Flow Meters)
Email: IscoService@teledyne.com

Return equipment to: 4700 Superior Street, Lincoln, NE 68504-1398

Other Correspondence

Mail to: P.O. Box 82531, Lincoln, NE 68501-2531
Email: IscoInfo@teledyne.com
Web site: www.isco.com

Important Safety Information

 DANGER

If Isco's 2151P Intrinsically Safe Area Velocity Flow System is installed in a hazardous area, it **MUST** be installed in accordance with control drawing 60-2003-227, shown on the following pages, and in accordance with the requirements of the authority that has jurisdiction for the installation of equipment in hazardous areas at your specific installation site.





The certified control drawing details the only approved method of installing the 2151P area velocity flow system in a hazardous area. Where specific Isco part numbers appear, they represent the only approved equipment certified to be used with the 2151P. Any equipment substitutions or installations not specifically detailed on the control drawing will automatically void the intrinsically safe certification of the 2151P and could result in fire or explosion!

Detailed hazardous area installation instructions for the 2151P are provided in Section 2 of this manual. Read this section carefully before beginning equipment installation! General safety information for working in confined spaces is provided in Appendix E.

The 2151P is listed as intrinsically safe for Class I, Div. 1, Groups C and D hazardous locations. This means that when it is **properly installed** in a Class I, Div. 1, Group C or D hazardous location, the circuits within the 2151P are designed to be incapable of producing a spark or thermal effect that could ignite a mixture of flammable or combustible gases. This does not mean that the 2151P is explosion proof. If the equipment is not installed properly in a hazardous area, or if proper safety precautions are not followed, there is a serious potential for an explosion. Carefully review the safety information, control drawing, and installation requirements and procedures **before** installing the 2151P!

Hazard Symbols

This manual uses symbols to warn of hazards. The symbols are explained below.

Hazard Symbols	
Warnings and Cautions	
	The exclamation point within the triangle is a warning sign alerting you of important instructions in the instrument's technical reference manual.
Symboles de sécurité	
	Ce symbole signale l'existence d'instructions importantes relatives au produit dans ce manuel.
Warnungen und Vorsichtshinweise	
	Das Ausrufezeichen in Dreieck ist ein Warnzeichen, das Sie darauf aufmerksam macht, daß wichtige Anleitungen zu diesem Handbuch gehören.
Advertencias y Precauciones	
	Esta señal le advierte sobre la importancia de las instrucciones del manual que acompañan a este producto.

Hazard Severity Levels

This manual applies *Hazard Severity Levels* to the safety alerts. These three levels are described in the sample alerts below.

 CAUTION
--

Cautions identify a potential hazard, which if not avoided, may result in minor or moderate injury. This category can also warn you of unsafe practices, or conditions that may cause property damage.

 WARNING
--

Warnings identify a potentially hazardous condition, which if not avoided, could result in death or serious injury.

 DANGER

Danger is limited to the most extreme situations to identify an imminent hazard, which if not avoided, will result in death or serious injury.

General Warnings

Before installing, operating, or maintaining the 2151P system, it is imperative that all hazards and preventive measures are understood. Be sure to read all safety information contained in this manual, in addition to the installation instructions in Section 2.

While specific hazards may vary according to location and application, take heed of the following general warnings:

 **WARNING**

Avoid hazardous practices! If you use these instruments in any way not specified in this manual, the protection provided by the instruments may be impaired; this will increase your risk of injury.

 **AVERTISSEMENT**

Eviter les manipulations hasardeuses! Si vous utilisez ces appareils de façon non conforme au mode d'emploi, vous risquez des blessures graves.

 **WARNING**

The installation and use of this product may subject you to hazardous working conditions that can cause you serious or fatal injuries. Take any necessary precautions before entering a worksite. Install and operate this product in accordance with all applicable safety and health regulations, and local ordinances.

L'installation de ces instruments peut vous entraîner à travailler dans des conditions précaires et risquées pouvant entraîner de graves blessures. Veuillez respecter toutes les conditions requises de sécurité avant de pénétrer dans un regard ou sur le site concerné. Installer et manipuler l'instrument selon les règles ou la législation en vigueur concernant la sécurité et la protection des individus.

2151P Area Velocity Flow System

Table of Contents

Section 1 Introduction

1.1 Product Description	1-1
1.2 2151P System Overview	1-2
1.2.1 Level	1-2
1.2.2 Velocity	1-2
1.2.3 Flow Rate	1-3
1.2.4 Total Flow	1-3
1.2.5 Data Storage	1-3
1.3 Identifying Module Components	1-4
1.4 Technical Specifications	1-6

Section 2 Preparation and Installation

2.1 Unpacking Instructions	2-1
2.2 Preparing for Installation	2-1
2.2.1 Locating the Site	2-2
2.2.2 Channels Without a Primary Device	2-2
2.2.3 Channels With a Primary Device	2-2
2.2.4 2151P and AV Sensor Mounting Considerations	2-3
2.3 Installing the AV Sensor and 2151P	2-3
2.3.1 Overview of Installation	2-3
2.3.2 Install the AV Sensor	2-3
2.3.3 Connecting the AV Sensor	2-5
2.3.4 Mounting the 2151P	2-6
2.3.5 Inspect the Desiccant	2-10
2.4 Power and Network Connections	2-10
2.4.1 Making Intrinsically Safe Wiring Connections	2-14
2.4.2 Making Non-intrinsically Safe Wire Connections	2-16
2.4.3 Connecting Using a Communication/ Barrier Cable	2-17
2.5 Connecting to the Isco Quick Disconnect Box	2-23
2.6 Program the Module	2-24
2.7 Mounting Rings	2-25
2.7.1 Spring Rings	2-25
2.7.2 Scissors Mounting Ring	2-27
2.7.3 Completing the AV Sensor Installation	2-29
2.8 Final Installation Check	2-30

Section 3 Programming

3.1 Section Overview	3-1
3.2 Flowlink Connections	3-1
3.3 Program Settings	3-1
3.3.1 Level	3-2
3.3.2 Zero Level Offset	3-3
3.3.3 No Velocity Data and Flow Rates	3-4
3.3.4 Flow Conversion	3-4
3.3.5 Silt Level	3-6

3.3.6 Data Storage Rates	3-6
3.3.7 Site Name	3-7
3.3.8 Module Name	3-7

Section 4 Modbus Protocol

4.1 Introduction	4-1
4.2 Operation	4-1
4.2.1 Establishing Communication	4-2
4.2.2 Module Addressing	4-2
4.3 Configurations	4-3
4.4 Glossary of Terms	4-4
4.5 Common Acronyms	4-5
4.6 Register Specifications	4-5

Section 5 Maintenance

5.1 Maintenance Overview	5-1
5.2 Maintenance Kit	5-1
5.3 Desiccant Maintenance	5-2
5.3.1 Reactivating the Desiccant	5-2
5.4 Channel Conditions	5-3
5.5 Other Maintenance	5-3
5.5.1 Hydrophobic Filter	5-3
5.5.2 Cleaning	5-3
5.5.3 Sensor Cable Inspection	5-4
5.6 How to Obtain Service	5-4
5.6.1 Diagnostics	5-4

Appendix A Replacement Parts

A.1 Replacement Parts Diagrams and Listings	A-1
---	-----

Appendix B Accessories

B.1 How to Order	B-1
B.2 General Accessories	B-1
B.3 AV Sensor Mounting Accessories	B-2

Appendix C Material Safety Data Sheets

C.1 Overview	C-1
------------------------	-----

Appendix D Safety Information

D.1 Safety Considerations	D-1
D.2 General Safety Procedures	D-1
D.3 Lethal Atmospheres in Sewers	D-4

List of Figures

1-1 2151P System, Top Left View	1-4
1-2 2151P System, Top Right View	1-5
1-3 Components - 2151P Area Velocity Sensor	1-6
1-4 2151P Area Velocity Flow System Communication Connector Pins	1-9
2-1 Connecting the AV Sensor	2-5

2-2	Mounting the 2151P in a Typical Round-pipe Installation	2-7
2-3	Control Drawing of 2151P Area Velocity Flow System Installation, Page 1	2-8
2-4	Control Drawing of 2151P Area Velocity Flow System Installation, Page 2	2-9
2-5	Typical Round-pipe Installation Connected to QD Box, 2108 Module, and 2101 Field Wizard with Network Isolator P/N 60-2004-224	2-11
2-6	Isolator and Barrier Connections	2-12
2-7	Terminal Connections to the 2108	2-17
2-8	Typical Round-pipe Installation Connected to a Laptop Computer With Cable P/N 60-2004-153	2-19
2-9	Intrinsically Safe Communication/Barrier Cable For Connection to a Computer	2-20
2-10	Entity Rated Power Barrier Connections When 2151P is Connected to a Laptop Computer Using Cable P/N 60-2004-153	2-20
2-11	Typical Round-pipe Installation Connected to a 2101 Field Wizard With Cable P/N 60-2004-201	2-22
2-12	Intrinsically Safe Communication/Barrier Cable For Connection to a 2101 or 2103 Module	2-23
2-13	Isco's Quick Disconnect Box	2-23
2-14	Wiring Inside Quick Disconnect Box	2-24
2-15	Sensor Installed on a Spring Ring	2-26
2-16	Scissors Ring adjustment	2-28
3-1	Preferred Measurement Location	3-3
3-2	Zero Level Offset Measurement	3-4
4-1	Configuration example	4-3

List of Tables

1-1	2151P Area Velocity Flow System - Top Left View	1-4
1-2	2151P Area Velocity Flow System - Top Right View	1-5
1-3	Components - 2151P Area Velocity Sensor	1-6
1-4	Specifications – 2151P Area Velocity Flow System Module	1-7
1-5	Specifications – Area Velocity Sensor	1-7
1-6	Communication Connector Pins	1-9
2-1	Entity Rated Power Barrier Intrinsically Safe Wire Connections	2-14
2-2	Network Isolator Intrinsically Safe Wire Connections	2-14
2-3	Entity Rated Power Barrier Non-Intrinsically Safe Wire Connections	2-16
2-4	Network Isolator Non-Intrinsically Safe Wire Connections	2-16
3-1	Flow Conversion Methods	3-5
4-1	Modbus ASCII Address 1 Register Definitions	4-6
4-2	Modbus ASCII Address 2-(N+1) Register Definitions	4-6
4-3	2100 Measurement Parameters by Model Number*	4-8

2151P Area Velocity Flow System

Section 1 Introduction

1.1 Product Description

The 2151P Intrinsically Safe Area Velocity Flow System is part of Isco's 2100 Series. The 2100 Series measures parameters of open channel flow streams.

The 2151P is designed for permanent installation and uses a power source located in a safe area.

Typical applications for the 2151P Area Velocity Flow System include:

- Sewer Flow
- Level measurement in explosive or potentially explosive areas, such as manholes, storage tanks, and digesters
- Measurement of shallow flows in small pipes
- Permanent flow monitoring

The 2151P Area Velocity Flow System is designed to be intrinsically safe, and allows installation of the module in Class I, Division 1, and Groups C and D hazardous locations. The concept of intrinsic safety is to limit the energy available to a given circuit or device to a level where electrical discharge (sparking) cannot ignite the hazardous (flammable or explosive) atmosphere. With no spark ignition possible, safe operation of the equipment in areas with hazardous atmospheres is possible.

The standard 2100 Series is designed to be modular so that you can expand the system by stacking modules to meet your data collection needs. Out of concern for your safety, the 2151P system was designed to prevent you from stacking additional modules onto the system.

The 2151P is connected to other 2100 Series modules using a network barrier cable or Isco Network Isolator. (Refer to Section 2 for installation drawings and instructions.)

The 2151P Area Velocity Flow System is paired with Isco's Flowlink for Windows software. With this full-featured application software, you can quickly set up the module, retrieve measurement data, manage the sites and analyze the data.

The 2151P's data storage memory is quite flexible, able to store the measurements in intervals from 15 seconds to 24 hours. The module can also be configured for variable rate data storage. Variable rates allow you to store data at a different interval when a programmed condition occurs.

The module's program and collected data are stored in Flash memory for security. Flash memory retains data without the concern of power failures. Its storage capacity is more than sufficient for most applications. The data storage memory can hold

approximately 79,000 readings ñ the equivalent of nine months of level and velocity data when stored at fifteen minute intervals. The flash memory also stores sensor calibration information. A separate flash memory device inside the module stores the operating firmware.

The rugged 2151P components are rated NEMA 4X, 6P (IP68). The permanently sealed enclosures are designed to meet the environmental demands of most sewer flow monitoring applications. All connections between sensors and communication cables lock in place. Each locking mechanism strongly secures the components and ensures a watertight seal.

1.2 2151P System Overview



AV Sensor

The 2151P measures liquid level and average stream velocity, and calculates the flow rate and total flow. The liquid level and velocity measurements are read from an attached Area Velocity (AV) Sensor that is placed in the flow stream. Flow rate calculations are performed internally using the measured parameters from the AV Sensor.

The 2151P is designed to provide durable operation with a minimal amount of routine maintenance. Routine maintenance can be performed in the field, while keeping hazardous location restrictions in mind. Typically, the 2151P System and its AV Sensor will only require that you keep the stream free from excessive debris, and replace spent desiccant. Sections 1.2.1 through 1.2.5 describe the 2151P and sensor in greater detail.

1.2.1 Level

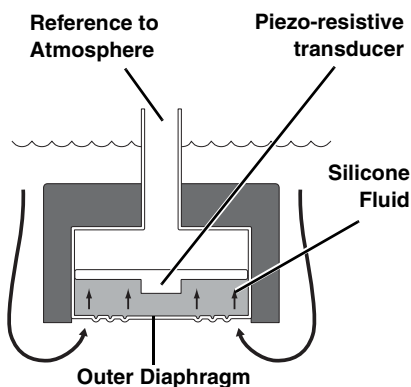

The AV Sensor's internal differential pressure transducer measures the liquid level. The transducer is a small piezo-resistive chip that detects the difference of the pressures felt on the inner and outer face.

The stainless steel outer diaphragm is exposed to the flow stream through the ports under the AV Sensor. The pressure felt on the outer diaphragm is transferred to the outer face of the transducer through a silicone fluid medium. The outer diaphragm and fluid isolate the sensitive transducer from direct exposure to the stream. The inner face of the transducer is exposed, or referenced, to the atmosphere through the internal vent tube that runs the full length of the AV Sensor's cable.

The difference between the pressures exerted on the transducer is the hydrostatic pressure. Hydrostatic pressure is proportional to the level of the stream. The analog representation of the hydrostatic pressure is digitized and sent to the 2151P Module using an RS-485 half-duplex signal.

1.2.2 Velocity

The AV Sensor measures average velocity by using ultrasonic sound waves and the Doppler effect. The Doppler effect states that the frequency of a sound wave (or other wave) passed from one body to another is relative to both their motions. As the two approach each other, the frequency increases; as they move apart, the frequency decreases.

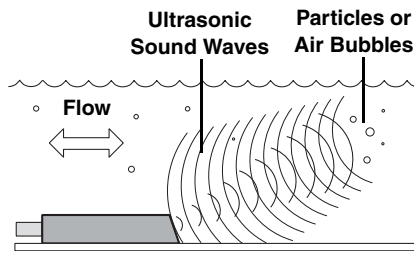

The AV Sensor contains a pair of ultrasonic transducers. One transducer transmits the ultrasonic sound wave. As the transmitted wave travels through the stream, particles and bubbles carried by the stream reflect the sound wave back towards the AV Sensor. The second transducer receives the reflected wave.

Circuits internal to the module compare the frequencies of the sound waves and extract the difference. An increase or decrease in the frequency of the reflected wave indicates forward or reverse flow. The degree of change is proportional to the velocity of the flow stream.

1.2.3 Flow Rate

Using measurements from the AV Sensor, the 2151P can calculate the flow rate. Many different flow rate conversion methods are supported:

- Area Velocity
- Data Points
- Manning Formula
- Two-term Polynomial Equations
- Flumes
- Weirs

Often the 2151P is chosen for applications where a primary device is not available, nor is it practical to install a primary device. Therefore, area velocity is usually the conversion method of choice.

The 2151P is capable of calculating and storing any two conversion methods simultaneously. This feature is useful when it is necessary to validate a flow conversion method. For example, the flow rate at a new site programmed for area velocity conversion can be directly compared to the flow rate calculated using a Manning formula.

1.2.4 Total Flow

The 2151P can calculate and report the total flow. You can set up the system to monitor *net*, *positive*, or *negative* total flow from either of the calculated flow rates.

1.2.5 Data Storage

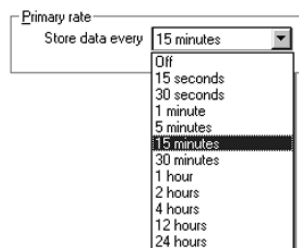

Through Flowlink, you configure which type of data is logged and the storage rate. For each measurement, the Data Storage Setup window lets you turn the primary rate off, or select a rate from 15 seconds to once every 24 hours. If the primary rate is turned off, the 2151P will not store the measurement (unless a secondary rate is selected). However, the 2151P will still take readings if that measurement type is necessary for a calculation.

Secondary rates are used to log data at a different rate when a user-defined condition exists. For example, a secondary rate can be used to increase the level and velocity data storage rate when level is greater than or equal to a point of interest. Secondary rates give you the best resolution of data, but only when it is needed. Until the condition is met, the module will conserve

power and memory by storing the data at the primary storage rate. Like the primary rate, you can turn the secondary rate off, or select a storage rate of 15 seconds to every 24 hours.

Time Resolution

The time resolution of each measurement is one second. That is, readings are taken at the same time as the time stamp, not collected and averaged over a period of time before the stamp.

Rollover Memory

Whether the measurements are stored at the primary or secondary rate, they are stored in a *rollover* type of memory. When full, the module overwrites the oldest data with the newest readings.

1.3 Identifying Module Components

The various components of the 2151P and sensor are shown in Figures 1-1 through 1-3. Items referenced in the figures are described in Tables 1-1 through 1-3.



Figure 1-1 2151P System, Top Left View

Table 1-1 2151P Area Velocity Flow System - Top Left View		
Item No. Fig. 1-1	Name	Description
1	Communication Indicator	Illuminates when module communications are active.
2	Serial Number Label	Lists the product ID and unit serial numbers, and defines the hazardous areas for which the 2151P is certified.
3	Desiccant Cartridge and Hydrophobic Filter	The cartridge holds desiccant that dries the reference air. The filter prevents moisture from entering the reference line.

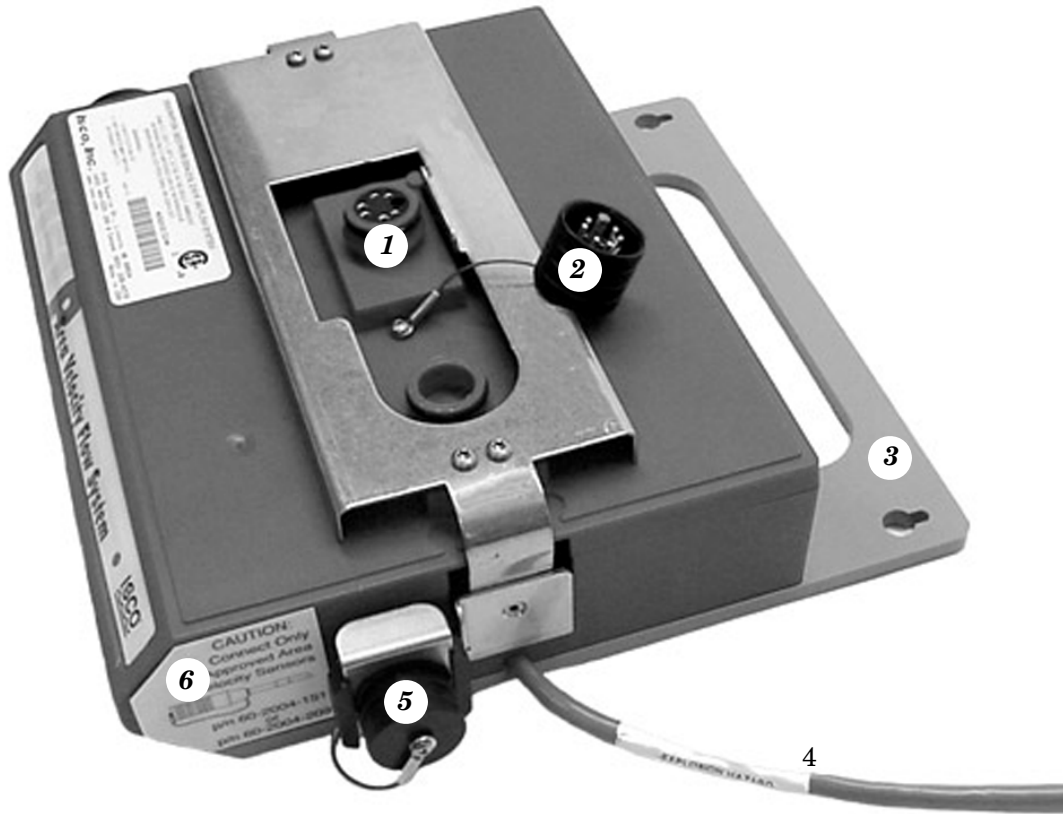

Figure 1-2 2151P System, Top Right View

Table 1-2 2151P Area Velocity Flow System - Top Right View		
Item No. Fig 1-2	Name	Description
1	Communication Connector	Used to connect to an intrinsically safe communication/barrier cable, which can then be connected to a 2100 Series module or laptop PC with Isco Flowlink software.
2	Connector Cap	Insert into unused communication connector to terminate the network and protect it from moisture damage. When the communication connector is in use, the cap must be stowed in its adjacent holder to protect the terminating components inside the cap.
3	Mounting Plate	Used to mount the unit.
4	Intrinsically Safe Power Cable	Used to connect the 2151P to a 12V DC power barrier.
5	AV Sensor Receptacle	Port used to attach the AV Sensor. Insert the protective plug when not in use.
6	AV Sensor Caution	Cautions user to attach only hazardous area rated sensors with specific Isco part numbers.



Figure 1-3 Components - 2151P Area Velocity Sensor

Table 1-3 Components - 2151P Area Velocity Sensor		
Item No. Fig. 1-3	Name	Description
1	Connector Cap	Protects the connector. When the connector is not in use, this cap must be in place to prevent damage to the connector pins and reference air tubing.
2	Connector	Attaches to the AV Sensor receptacle on the 2151P Module.
3	Serial Number Label Safety Warning	Lists product ID and unit serial numbers. Read the label for important safety information.
4	AV Sensor Body	The AV Sensor Body is placed in the flow stream to measure level and velocity.
5	Cable	25 ft (7.6 m) cable containing the reference air tubing and conductors to transfer level data, velocity data, and AV Sensor power. (A 75 ft (22.8 m) cable is available.)

1.4 Technical Specifications

The following tables provide technical information about the 2151P Area Velocity Flow System and its related components.

- Table 1-4 lists the technical specifications of the 2151P system.
- Table 1-5 lists the technical specifications of the Area Velocity Sensor.
- Figure 1-4 and Table 1-6 list information about the 2151P's communication connector.

Table 1-4 Specifications – 2151P Area Velocity Flow System Module		
Size (H×W×D)	3.75 × 9.5 × 11.0 inches	9.5 × 24.0 × 28.0 cm
Weight	6.0 lbs (2.5 kg)	
Material	High-impact molded polystyrene	
Enclosure Rating	NEMA 4X, 6P	IP 68
Power	12V DC, 100 mA nominal (CSA approved intrinsically safe)	
Program Memory	Non-volatile, programmable flash; can be updated using PC without opening enclosure; retains user program after updating	
Flow Rate Conversions	Up to 2 independent level-to-area and/or level-to-flow rate conversions	
Level-to-Area Conversions		
Channel Shapes	Round, U-shaped, rectangular, trapezoidal, elliptical, with silt correction	
Data Points	Up to 50 level-area points	
Level-to-Flow Rate Conversions		
Weirs	V-notch, rectangular, Cipolletti, Isco Flow Metering Inserts, Thel-Mar	
Flumes	Parshall, Palmer-Bowlus, Leopold-Lagco, trapezoidal, H, HS, HL	
Manning Formula	Round, U-shaped, rectangular, trapezoidal	
Data Points	Up to 50 level-flow rate points	
Equation	2-term polynomial	
Total Flow Calculations	Up to 2 independent, net, positive or negative, based on either flow rate conversion	
Data Storage Memory	Non-volatile flash; retains stored data during program updates	
Capacity	395,000 bytes (up to 79,000 readings, equal to over 270 days of level and velocity readings at 15 minute intervals, plus total flow and input voltage readings at 24 hour intervals)	
Data Types	Level, velocity, flow rate 1, flow rate 2, total flow 1, total flow 2, input voltage	
Storage Mode	Rollover with variable rate data storage based on level, velocity, flow rate 1, flow rate 2, total flow 1, total flow 2, or input voltage	
Storage Interval	15 or 30 seconds; 1, 2, 5, 15, or 30 minutes; or 1, 2, 4, 12, or 24 hours	
Bytes per reading	5	
Setup and Data Retrieval	Serial connection to IBM PC or compatible computer with Isco Flowlink for Windows <i>Software Version 4.x</i>	
Baud Rate	38,400	
Operating Temperature	0° to 140°F	-18° to 60°C
Storage Temperature	-40° to 140°F	-40° to 60°C

Table 1-5 Specifications – Area Velocity Sensor		
Size (H×W×D)	0.75 × 1.31 × 6.0 inches	1.9 × 3.3 × 15.2 cm
Cable Length	25 ft.	7.6 m
Cable Diameter	0.37 inches	0.9 cm
Weight (<i>including cable</i>)	2.1 lbs	0.95 kg

Table 1-5 Specifications – Area Velocity Sensor (Continued)

Level Measurement	
Method	Submerged pressure transducer mounted in the flow stream
Transducer Type	Differential linear integrated circuit pressure transducer
Range	0.033 to 10 ft. 0.010 to 3.05 m
Maximum Submersible Depth	20 ft. 6.1 m
Accuracy ¹	Level ² Error
	0.033 to 5.0 ft. (0.03 to 1.52 m) ±0.008 ft./ft. (±0.008 m/m) Greater than 5.0 ft. (1.52 m) ±0.012 ft./ft. (±0.012 m/m)
Maximum Long-term Drift	0.033 ft. 0.010 m
Temperature Coefficient ³	±0.0035 ft./°F ±0.0019 m/°C
Velocity Measurement	
Method	Doppler Ultrasonic
Frequency	500 kHz
Transmission Angle	20° from horizontal
Typical Minimum Depth for Velocity Measurement	1.0 inch 25 mm
Range	-5 to +20 ft./s -1.5 to +6.1 m/s
Accuracy ⁴	Velocity Error
	-5 to +5 ft./s (-1.5 to +1.5 m/s) ±0.1 ft./s (±0.03 m/s) 5 to 20 ft./s (1.5 to 6.1 m/s) ±2% of reading
Operating Temperature	32° to 160°F 0° to 71°C
Compensated Temperature Range	32° to 122°F 0° to 50°C
Materials	
Sensor	Epoxy, chlorinated polyvinyl chloride (CPVC), stainless steel
Cable	Polyvinyl chloride (PVC), chlorinated polyvinyl chloride (CPVC)

Notes:

1. Non-linearity and hysteresis at 77°F (25°C) (per foot of change from calibration depth)
2. Actual vertical distance between the area velocity sensor and the liquid surface
3. Maximum error within compensated temperature range (per degree of change from calibration temperature)
4. In water with a uniform velocity profile and a speed of sound of 4850 ft./s (1480 m/s)

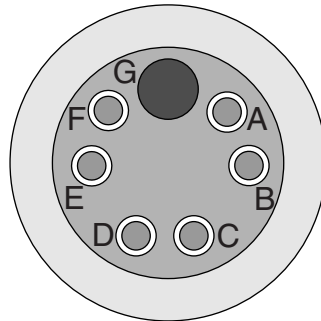

Communications Port

Figure 1-4 2151P Area Velocity Flow System
 Communication Connector Pins

Table 1-6 Communication Connector Pins		
Pin	Name	Description
A	NETA	Network differential transceiver Data A
B	NETB	Network differential transceiver Data B
C	VIN+	Positive power supply voltage input (+12 VDC nominal)
D	VIN-	Negative power supply voltage input (0 VDC nominal)
E	RCVUP	Logic level data receive
F	XMTUP	Logic level data transmit
G	Key	Aligns connector pins

2151P Area Velocity Flow System

Section 2 Preparation and Installation

2.1 Unpacking Instructions

When the system arrives, inspect the outside packing for any damage. Then carefully inspect the contents for damage. If there is damage, contact the delivery company and Teledyne Isco (or its agent) immediately.

WARNING

If there is any evidence that any items may have been damaged in shipping, do not attempt to install the unit. Please contact Teledyne Isco (or its agent) for advice.

Teledyne Isco, Inc.
Customer Service Dept.
P.O. Box 82531
Lincoln, NE 68501 USA

Phone:(800) 228-4373
Outside USA & Canada call:
(402) 464-0231

FAX: (402) 465-3022

E-mail:
IscoInfo@teledyne.com

When you unpack the system, check the items against the packing list. If any parts are missing, contact the delivery company and Teledyne Isco's Customer Service Department. When you report missing part(s), please indicate them by part number. In addition to the main packing list, there may be other packing lists for various sub-components.

It is recommended that you retain the shipping cartons as they can be used to ship the unit in the event that it is necessary to transport the system.

Please complete the registration card and return it to Teledyne Isco, Inc.

2.2 Preparing for Installation

This equipment is intended to be installed in a Class I, Div. 1, Groups C and D hazardous location. When installed in a hazardous area, the equipment **MUST** be installed according to the installation control drawing P/N 60-2003-227, shown in Figures 2-3 and 2-4, and the requirements of the authority having jurisdiction at the installation site.

WARNING

Avoid hazardous practices! If you use these instruments in any way not specified in this manual, the protection provided by the instruments may be impaired; this will increase your risk of injury.

 **WARNING**

The installation and use of this product may subject you to hazardous working conditions that can cause you serious or fatal injuries. Take any necessary precautions before entering a worksite. Install and operate this product in accordance with all applicable safety and health regulations, and local ordinances.

The 2151P system components are often installed in confined spaces. Some examples of confined spaces include manholes, pipelines, digesters, and storage tanks. These spaces may become hazardous environments that can prove fatal for those unprepared. These spaces are governed by OSHA 1910.146 and require a permit before entering. Section E contains general safety information regarding confined spaces.

2.2.1 Locating the Site

The 2151P is designed to measure flow in open channels with or without a primary device. A primary device is a hydraulic structure, such as a weir or a flume that modifies a channel so there is a known relationship between the liquid level and the flow rate. Although the 2151P supports flow-rate conversion in channels with a primary device, its level and velocity measurement capabilities are best suited for channels *without* a primary device.

 **Note**

Primary devices limit the usefulness of the AV Sensor's readings. In most cases, levels and velocities near these structures do not represent what normally occurs in the channel. If you must use area velocity flow conversion, or if your interest is the stream's velocity, do not install the AV Sensor near a primary device. Move the AV Sensor away to where the flow is unaffected by the primary device.

2.2.2 Channels Without a Primary Device

When the AV Sensor is installed without a primary device, find a section of channel with a minimum of disturbances to the flow. Avoid areas with elbows, outfalls, invert, junctions, etc. that create turbulence near the AV Sensor. The AV Sensor should be located away from these disturbances to a point where the flow has stabilized. For best results, install the AV Sensor where the flow is most uniform. Uniform flow is a condition where the water surface is parallel to the bottom of the channel.

2.2.3 Channels With a Primary Device

If the AV Sensor is installed in a primary device, its location depends on the type of primary device. Most primary devices have a specific place for the head (level) measurement sensor. For more details about the location of the head measuring point, refer to the *Isco Open Channel Flow Measurement Handbook*, or to information provided by the manufacturer of the primary device.

 **Note**

When you install the AV Sensor for use within a primary device, a Level-to-Flow conversion method should be used. (See Programming, Section 3.)

2.2.4 2151P and AV Sensor Mounting Considerations

Ideal sites are easily accessible for service and data collection, while still providing protection for the 2151P system devices. The 2151P system devices are rated NEMA 4X, 6P, and constructed of materials that can withstand harsh environments. However, continual exposure to UV light, or periodic submersion should be avoided to extend the life of the components.

Typically, the 2151P is mounted inside a manhole. Mounting the 2151P near the opening will protect it from the elements, minimize the chance of submersion, and allow it to be easily retrieved without entering the manhole. The 2151P can be installed using the optional Isco Quick Disconnect Box.

The AV Sensor must be installed within 25 feet (7.6 m) of the 2151P system (unless you are using the optional 75 ft (22.8 m) sensor cable.)

2.3 Installing the AV Sensor and 2151P

The instructions in this section tell you how to install and attach the AV Sensor, mount the 2151P, and inspect the desiccant. Refer to Section 2.4 for details on how to make wiring and network connections.

2.3.1 Overview of Installation

The following general steps may be used as a guide to install a 2151P Area Velocity Flow System, which includes the 2151P module, an AV Sensor, and an intrinsically safe 12V DC power source. (Your installation may also include an Isco hazardous location quick disconnect box, network isolator, and various Isco 2100 Series modules.)

1. Install the AV Sensor in the flow stream (2.3.2).
2. Attach the AV Sensor cable to the 2151P Module (2.3.3).
3. Mount the 2151P (Section 2.3.4 and Figures 2-3 and 2-4)
4. Inspect 2151P module desiccant (2.3.5).
5. Make the necessary wire and network connections (2.4).
6. Connect to the site with *Flowlink for Windows* software (2.6).
 - a. Create the site by Quick Connecting to the modules.
 - b. Set up the site and module settings.
 - c. Calibrate the level measurement.
7. Disconnect from the site.

2.3.2 Install the AV Sensor

AV Sensor installation is discussed in *Isco's Mounting Rings Instruction Manual*. The manual explains how to mount the low profile AV Sensor in flow streams using spring rings, scissors rings, a street level installation tool, and mounting plates.

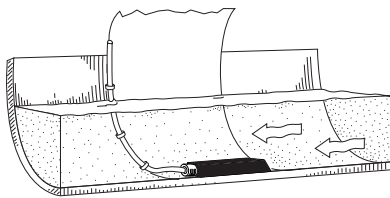

Ideal Conditions - Uniform Flow

Several factors concerning the AV Sensor's installation may affect your system's performance. Please review the following to understand how to obtain the best results:

Uniform flow - The AV Sensor provides the best results in flow streams with uniform flow, as shown in the margin.

Avoid poor channel conditions - Poor channel conditions may cause incorrect or erratic readings. Areas to avoid are:

- outfalls or channel intersections
- flow streams at very low levels with high flow rates
- turbulence
- channel sections that are apt to collect debris or silt
- depths that consistently run below 1 inch (25 mm).

Install the AV Sensor in streams where the liquid covers the sensor. The AV Sensor can detect levels above approximately 0.033 feet (0.4 inch or 1.0 cm) and typically can measure velocities in streams as low as 0.08 ft (1 inch or 25 mm). Streams that consistently run below 1 inch are not a good application for the 2151P.

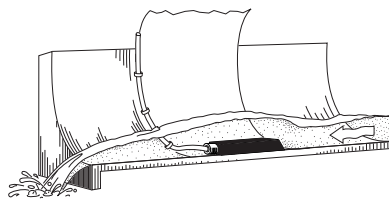

Poor Conditions

The example in the margin shows a few of these poor conditions. The outfall is drawing down the liquid level and the AV Sensor is disturbing the flow. In this example, the AV Sensor should be moved forward to avoid the drawdown near the outfall.

Offsets - You can install the AV Sensor above the bottom of the flow stream or along the side of the channel, as long as it will be continually submerged. The AV Module can be calibrated to measure level with the AV Sensor at nearly any depth. The AV Sensor cannot, of course, measure a liquid level that falls below its position in the flow stream. Installing the AV Sensor above the bottom has several advantages:

- It avoids heavy concentrations of silt, sand, or other solids.
- It aids installation in narrow or hard-to-reach locations.
- It maximizes level resolution over a specific level range.
- It can avoid obstructions in the flow stream.

When the AV Sensor is installed above the bottom of the channel, a *Zero Level Offset* must be entered in the program settings.

Liquid properties - Velocity measurements depend on the presence of some particles in the stream such as suspended solids or air bubbles. If the stream lacks particles it may be necessary to aerate the water upstream from the sensor.

Handle with care - Abusive handling will damage the AV Sensor. Although the AV Sensor will survive normal handling and installation, treat the sensor with reasonable care. The internal components cannot be repaired.

Protect the cable - There is a vent tube inside the cable that must remain open. Do not kink the cable or overtighten the plastic ties while securing the cable.

Secure the cable - Teledyne Isco recommends that you secure the cable in place. Tying off the cable can often prevent lost equipment if excessive flow dislodges the sensor and its mounting. Avoid leaving excess AV Sensor cable in the flow stream where it may collect debris.

2.3.3 Connecting the AV Sensor

After you have mounted the 2151P, attach the AV Sensor cable to the sensor receptacle on the 2151P.

To connect the AV Sensor (refer to Figure 2-1):

1. Remove the protective plug and cap:
 - a. On the 2151P Module, push down on the sensor release while pulling the protective plug from the receptacle.
 - b. On the AV Sensor cable, pull the cap from the end of its connector.
2. Prepare the AV Sensor connector:
 - a. Inspect the connector. It should be clean and dry. Damaged O-rings must be replaced. Spare O-rings (Isco P/N 202-1006-69) are supplied in the maintenance kit (60-2059-001).
 - b. Spray the O-ring's sealing surface with a *silicone* lubricant.

Note

Do not use petroleum-based lubricants. Petroleum-based lubricants will cause the O-ring to swell and eventually deteriorate. Aerosol silicone lubricant sprays often use petroleum based propellants. If you are using an aerosol spray, allow a few minutes for the propellant to evaporate before proceeding.

3. Align and insert the connector. The sensor release will “click” when the sensor connector is fully seated.
4. Connect the cap and plug together.

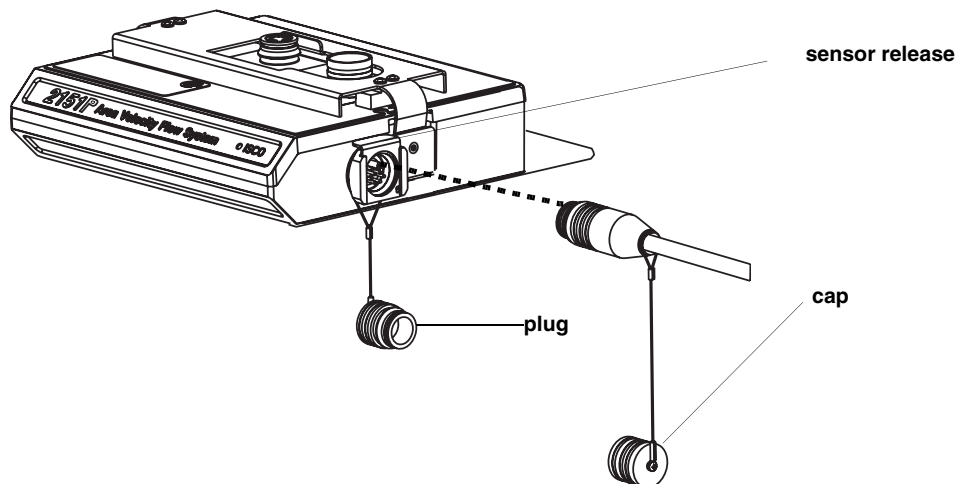

Figure 2-1 Connecting the AV Sensor

2.3.4 Mounting the 2151P

When the 2151P Area Velocity Flow System is installed in a hazardous area, it **MUST** be assembled and installed as shown in the installation control drawing P/N 60-2003-227 (Figures 2-3 and 2-4) in order to maintain intrinsic safety.

Figure 2-2 shows the 2151P mounted inside a manhole; your setup would be similar.

Make sure the 2151P is secured so that it will not accidentally fall or be swept away by flooding. Mount the 2151P using the back plate that extends from the back of the module. Use the holes in the back plate to insert fasteners to secure the module to a wall, or attach a carrying handle (P/N 60-1704-017) that can be secured to a ladder rung.

The module should be positioned where it will be protected from submersion. Should the module become submerged, level readings may drift and the hydrophobic filter will seal to protect the reference air line. If the possibility of *short-term* submersion cannot be avoided, you can prevent the drifting level readings and damage to the hydrophobic filter. Attach a length of 1/8 inch I.D. tubing (Isco P/N 60-2003-104) to the hydrophobic filter. Route the other end of the tubing to a dry location within the same area.

Note

To protect the 2151P AV Flow System and sensor, the hydrophobic filter seals off the reference air line when it is exposed to excessive moisture. When sealed, the filter prevents irreparable damage, yet may cause the level readings to drift. This single-use filter must be replaced once it becomes sealed. See Section 5.5.1 for more information.

If the communication connection on top of the unit is unused, it must be capped to prevent damage and terminate the communication line. If the communication connector is in use, its cap should be properly stowed. The protective cap and its O-ring should be cleaned and coated with a silicone lubricant. A damaged O-ring must be replaced (Isco P/N 202-1006-69).

The 2151P's intrinsically safe power cable must be kept clear from any other objects or wires, except for the connections shown in Figure 2-3. The power cable should be routed through conduit (as shown in Figure 2-2) to the safe area, where it must be connected to an entity rated power barrier. (If an Isco Quick Disconnect Box is used, as described in Section 2.6, the 2151P power cable will be connected to the QD Box and the six conductor cable with shield drain wire from the QD Box will be connected to the entity rated power barrier.)

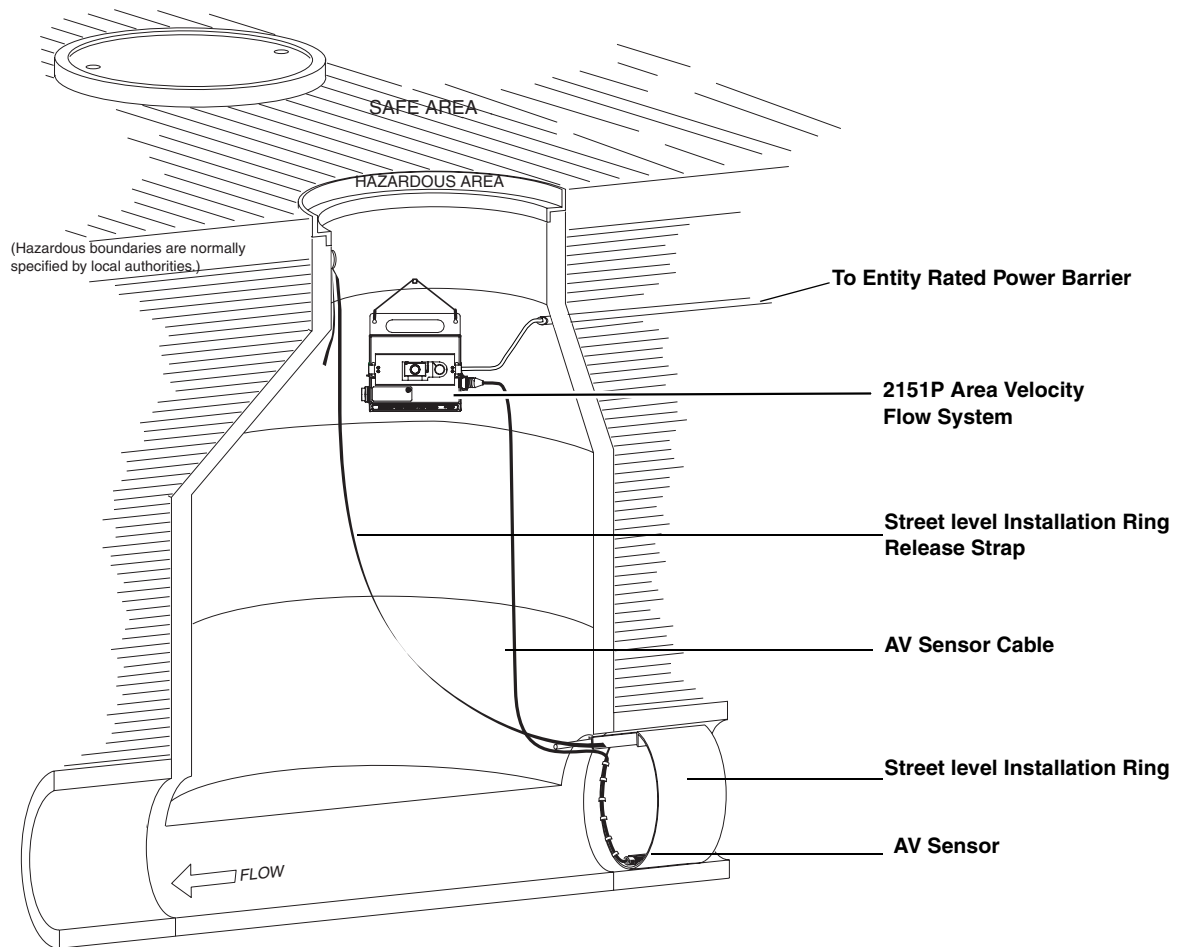

Figure 2-2 Mounting the 2151P in a Typical Round-pipe Installation

⚠ WARNING

All installations in areas that are rated as hazardous locations must conform to the 2151P installation control drawing P/N 60-2003-227, as shown in Figures 2-3 and 2-4.

2151P Area Velocity Flow System
 Section 2 Preparation and Installation

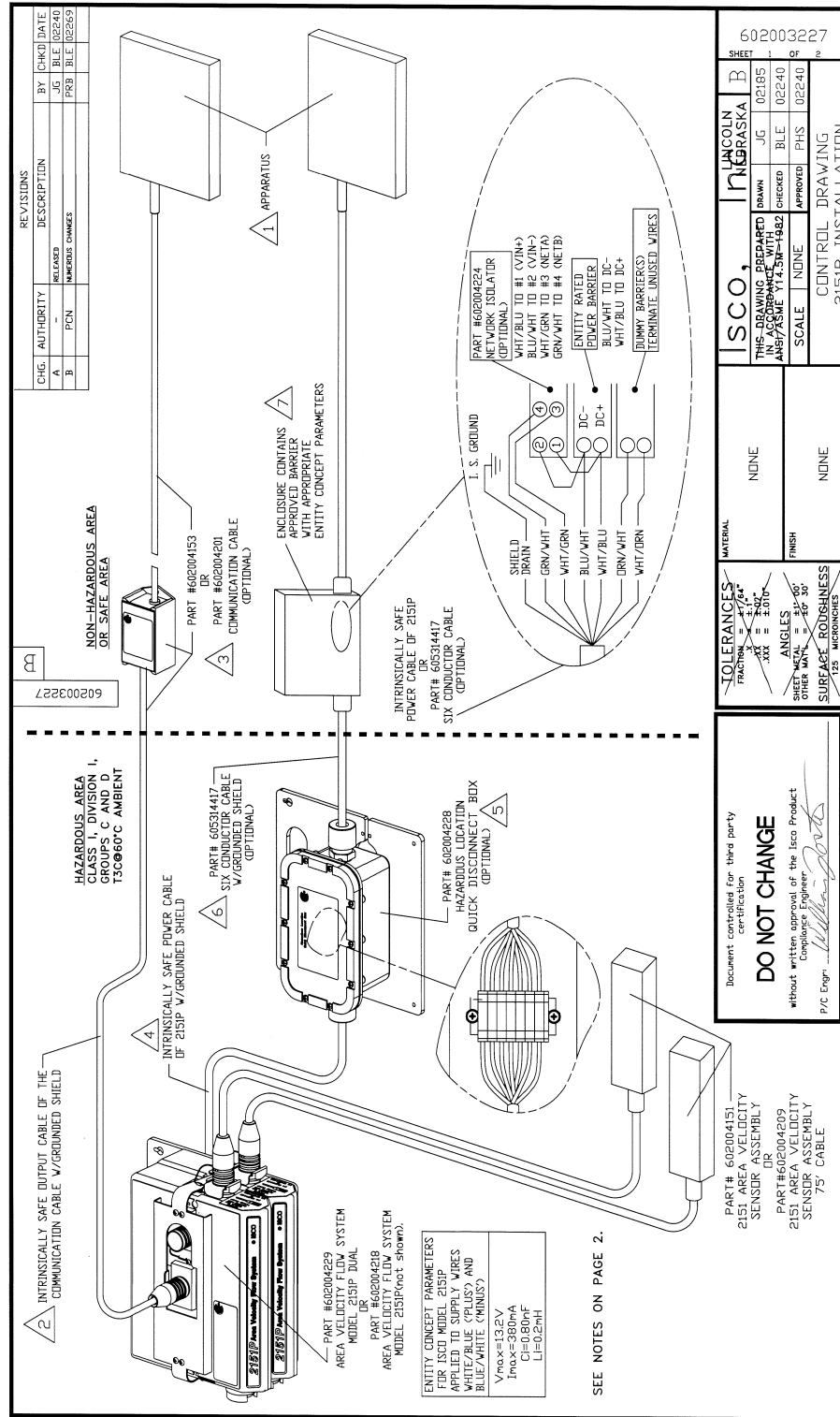

Figure 2-3 Control Drawing of 2151P Area Velocity Flow System Installation, Page 1

INSTALLATION NOTES:

- 1 APPARATUS CONNECTED MUST NOT GENERATE MORE THAN 250V WITH RESPECT TO THE EARTH UNDER ABNORMAL OR NORMAL CONDITIONS.
- 2 EXPLOSION HAZARD – INTRINSICALLY SAFE OUTPUT CABLE OF THE COMMUNICATION CABLE MUST BE KEPT CLEAR FROM ANY OTHER OBJECTS OR WIRES.
- 3 ISCO COMMUNICATION CABLE SELECTION IS OPTIONAL EQUIPMENT AND MAY BE INSTALLED OR REMOVED FROM THE 2151P DURING OPERATION.
- 4 EXPLOSION HAZARD – INTRINSICALLY SAFE OUTPUT CABLE OF 2151P MUST BE KEPT CLEAR FROM ANY OTHER OBJECTS OR WIRES EXCEPT FOR CONNECTIONS SHOWN.
- 5 ISCO PART #602004228 HAZARDOUS LOCATION QUICK DISCONNECT BOX IS OPTIONAL EQUIPMENT. INSTALL SHIELD DRAIN WIRE AND WIRING WITH LIKE COLORS IN CONTACT.
- 6 MAXIMUM CABLE LENGTH BETWEEN OPTIONAL QUICK DISCONNECT BOX AND APPROVED BARRIER ENCLOSURE IS 800 METERS WHEN R.STAHL BARRIER MODEL 9381/10-124-195 IS USED (ISCO PART #341001201 PWR ISLTR HAZ LOC). ONLY ISCO PART #605314417 CABLE IS APPROVED OR PERMITTED FOR INTRINSICALLY SAFE INSTALLATIONS.
- 7 SELECT APPROPRIATE APPROVED POWER BARRIER AND ENCLOSURE PER LOCAL STATUTE AND PRACTICE. ISCO PART #602004224 NETWORK ISOLATOR IS OPTIONAL EQUIPMENT. UNUSED WIRES TO BE TERMINATED WITH APPROPRIATE DUMMY BARRIERS.

Barrier/Associated Equipment must be ground-referenced and meets the following conditions:

1. Entity Parameters: $V_{max} = 13.2$ Volts, $I_{max} = 380$ mA, $C_i = 0.80$ nF, $L_i = 0.2$ mH.
2. Barriers must be CSA Certified and installed in accordance with manufacturer's instructions.
3. Maximum non_hazardous area voltage must not exceed 250V.
4. Install in accordance with the Canadian Electrical Code, Part I for installation in Canada.
5. Install in accordance with the NEC (ANSI/NFPA 70) and ANSI/ISA RP12.6. for installation in U.S.
6. Entity parameters must meet the following requirements:
 $V_{max} \geq V_{oc}$
 $I_{max} \geq I_{sc}$
 $C_i + C_{cable} \leq C_a$
 $L_i + L_{cable} \leq L_a$

<p>TOLERANCES</p> <p>FRACTION = $\pm 1/64"$</p> <p>.X = $\pm .1"$</p> <p>.XX = $\pm .02"$</p> <p>.XXX = $\pm .010"$</p> <p>ANGLES</p> <p>SHEET METAL = $\pm 1' 00'$</p> <p>OTHER MAT'L = $\pm 0' 30'$</p> <p>SURFACE ROUGHNESS</p> <p>125 MICRORINCHES MAXIMUM</p>	<p>MATERIAL</p> <p>NONE</p> <hr/> <p>FINISH</p> <p>NONE</p>	<p>isco, Lincoln NEBRASKA B</p> <p>THIS DRAWING PREPARED IN ACCORDANCE WITH ANSI/ASME Y14.5M-1982</p> <p>SCALE</p> <p>CONTROL DRAWING 2151P INSTALLATION</p>	<table border="1" style="width: 100%; border-collapse: collapse;"> <tr> <td style="width: 15%;">DRAWN</td> <td style="width: 15%;">JG</td> <td style="width: 15%;">02185</td> </tr> <tr> <td>CHECKED</td> <td>BLE</td> <td>02240</td> </tr> <tr> <td>APPROVED</td> <td>PHS</td> <td>02240</td> </tr> </table> <p style="writing-mode: vertical-rl; transform: rotate(180deg);">SHEET 2 OF 2 602003227</p>	DRAWN	JG	02185	CHECKED	BLE	02240	APPROVED	PHS	02240
DRAWN	JG	02185										
CHECKED	BLE	02240										
APPROVED	PHS	02240										

Figure 2-4 Control Drawing of 2151P Area Velocity Flow System Installation, Page 2

2.3.5 Inspect the Desiccant

A desiccant cartridge is inserted into the side of the 2151P module. The cartridge is filled with silica gel beads that will indicate when they are saturated. When dry, the beads are yellow or blue. As the desiccant becomes saturated, the humidity levels will increase and the beads turn green or pink.

If the entire length of the desiccant cartridge turns green or pink, the reference air is no longer adequately protected and the desiccant must be replaced. Refer to section 5.3 for replacement instructions.

 CAUTION
--

Operating the 2151P and sensor with saturated desiccant can cause many problems such as drifting level readings and permanent damage. It is important that the equipment is serviced often enough to prevent the entire desiccant cartridge from becoming saturated.

2.4 Power and Network Connections

After the AV sensor has been installed and the 2151P has been mounted, you need to make the power and network connections.

A typical installation is shown in Figure 2-5, with a callout showing detailed wiring connections in Figure 2-6.

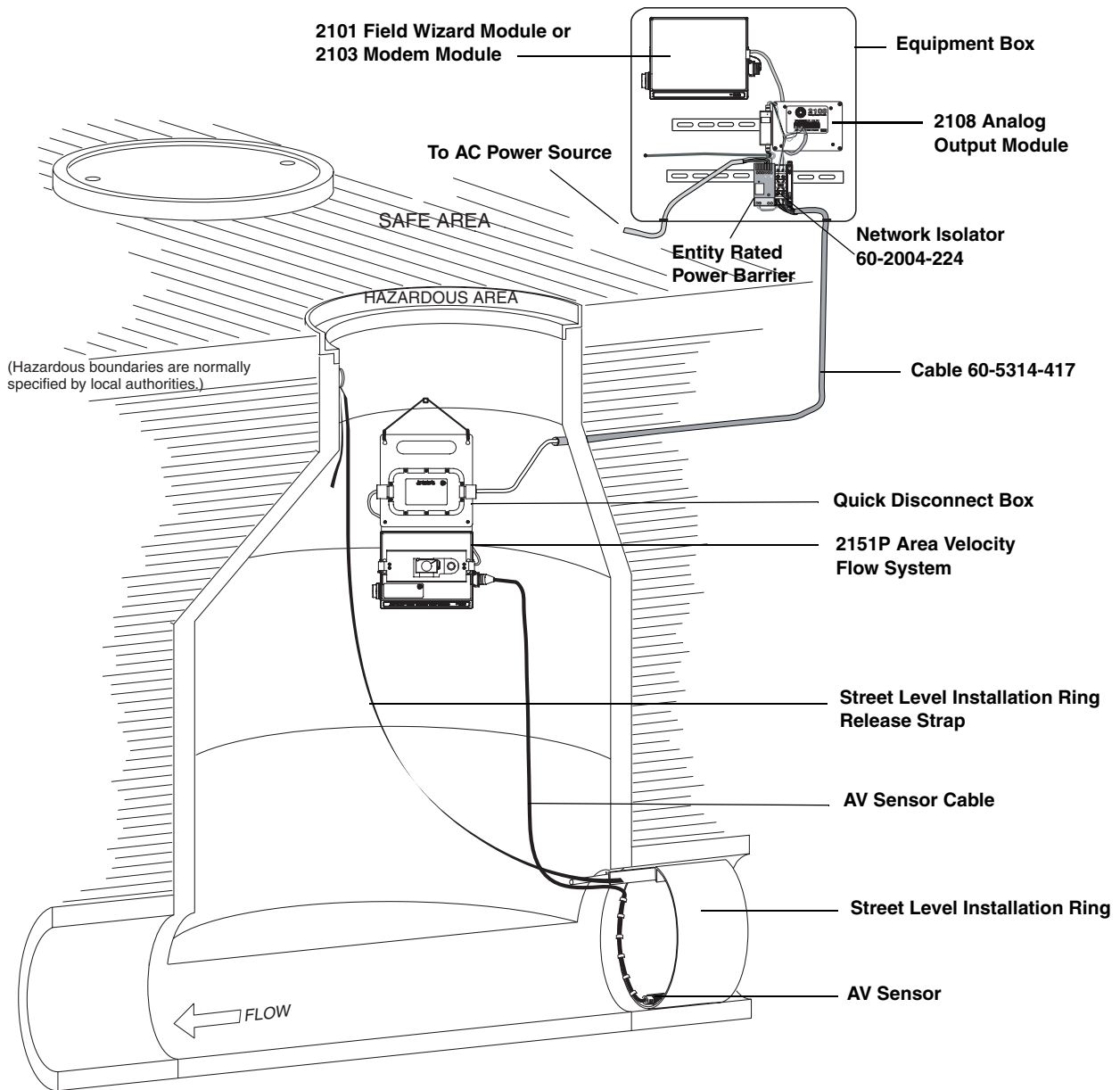

Figure 2-5 Typical Round-pipe Installation Connected to QD Box, 2108 Module, and 2101 Field Wizard with Network Isolator P/N 60-2004-224

⚠ WARNING

All installations in areas that are rated as hazardous locations must conform to the 2151P installation control drawing P/N 60-2003-227, as shown in Figures 2-3 and 2-4.

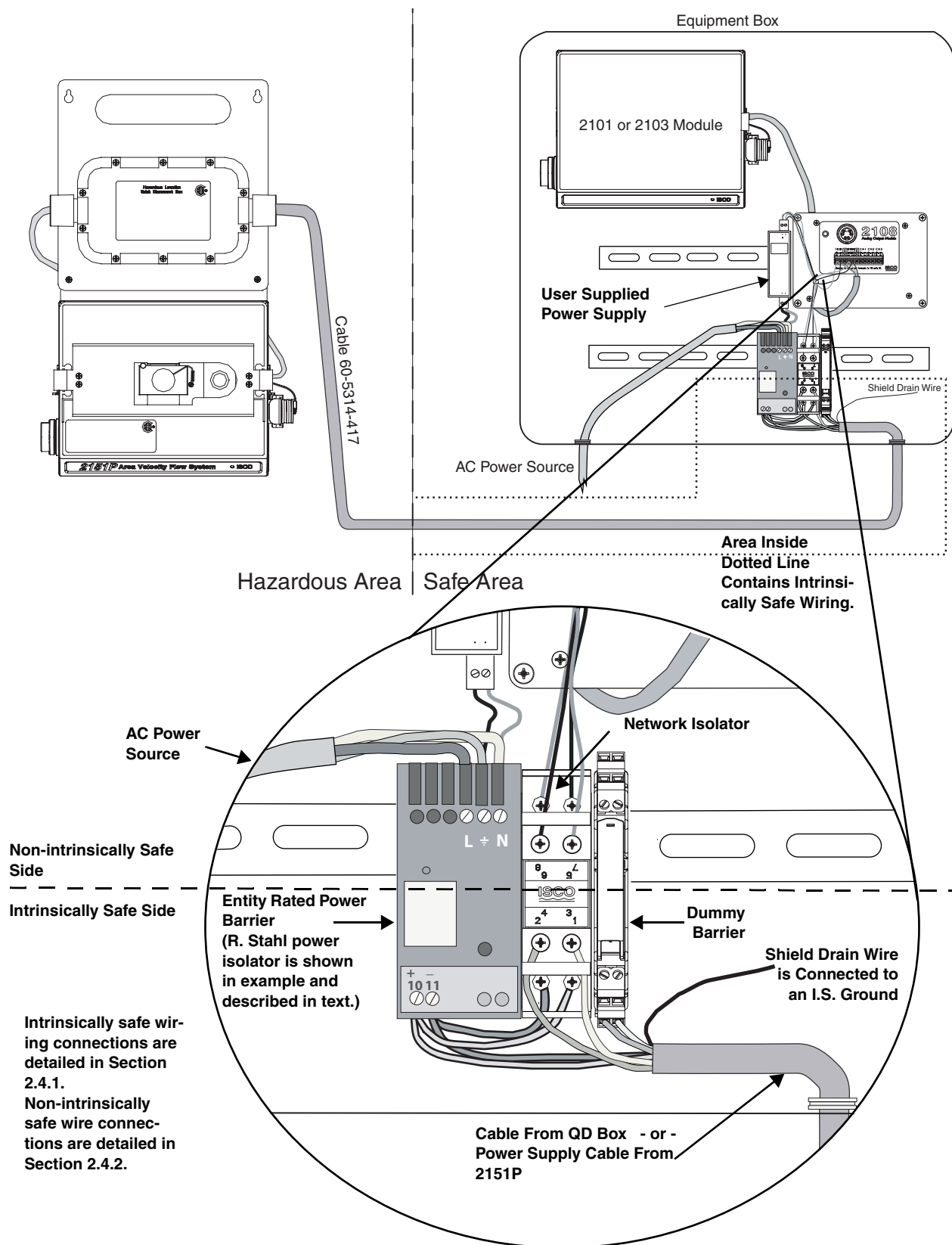

Figure 2-6 Isolator and Barrier Connections

The example in Figure 2-5 portrays a 2151P used with a network isolator, 2108 analog output module, and 2101 Field Wizard, along with associated barriers and cables. Your specific configuration may vary; if you have any questions concerning your specific site, contact a Teledyne Isco service representative.

All installations in hazardous locations **must** conform to the 2151P installation control drawing P/N 60-2003-227, as shown in Figures 2-3 and 2-4, in addition to the requirements of the authority having jurisdiction over the installation site. When installing the 2151P system, keep the following points in mind:

Intrinsically Safe Wiring

Note in Figure 2-6 that the area inside the dotted line contains intrinsically safe wiring (wiring that enters the hazardous area), which is connected to the intrinsically safe terminals of the entity rated power barrier, network isolator, and dummy barrier.

The intrinsically safe terminals are usually identified with light blue, and in our examples are located on the lower halves of the power barrier, network isolator, and dummy barrier.

Intrinsically safe wiring must leave or enter the safe (non-hazardous) area by the shortest, most direct route. If possible, equipment in the safe area should be located as close as possible to the hazardous location. This will minimize the length of intrinsically safe conductors within the safe area. Local electrical codes may dictate how intrinsically safe wiring should be routed; we recommend checking applicable local codes before installation.

Non-intrinsically Safe Wiring

Non-intrinsically safe wiring (wiring that is in the safe area only) must be kept separate from the intrinsically safe wiring, and is connected to the non-intrinsically safe terminals of the entity rated power barrier and network isolator.

In our example, the non-intrinsically safe terminals are located on the upper halves of the power barrier and network isolator. Non-intrinsically safe wiring should **NEVER** be connected to the intrinsically safe terminations of any associated equipment!

 **CAUTION**

Intrinsically safe wiring **MUST** be separated from non-intrinsically safe wiring in order to prevent transfer of unsafe levels of energy to the hazardous area!

Mounting Considerations

Because dust and moisture are conductive, equipment in the safe area should be mounted in an enclosure that is dust and moisture free. The panel layout should be constructed so that it allows adequate clearance between intrinsically safe and non-intrinsically safe wiring. As a safety measure, we recommend a clearance distance of at least 2 inches (50 mm) between any intrinsically safe wiring and non-intrinsically safe wiring.

Raceways or plastic ties should be used to keep intrinsically safe and non-intrinsically safe wiring separated from each other. Identify intrinsically safe wiring with permanently attached labels that state the wiring is intrinsically safe.

Once installed in the hazardous area, the 2151P is connected to equipment in the safe area by following the steps in sections 2.4.1 and 2.4.2.

2.4.1 Making Intrinsically Safe Wiring Connections

1. Route the power supply cable from the 2151P through conduit and into the control panel (located in a safe area). The end of the power supply cable has six wires plus a shield drain wire, which will be connected inside the control panel.

(If the 2151P is connected to Isco's hazardous location quick disconnect (QD) box (P/N 60-2004-228), a six conductor cable (P/N 60-5314-417) will be run from the QD box into the control panel. Wire connections will be the same as for the power supply cable.)

Refer to Figures 2-3 and 2-6 for connections.

2. Power to the 2151P will be routed through an entity rated power barrier (our example shows a Stahl power isolator). The intrinsically safe terminal connections are shown below in Table 2-1.

Table 2-1 Entity Rated Power Barrier Intrinsically Safe Wire Connections	
Connector (on Stahl power isolator)	Connection
10	DC+ white/blue wire
11	DC- blue/white wire

3. Terminal connections for the network isolator (P/N 60-2004-224) are printed on its side label. The intrinsically safe connections are shown below in Table 2-2.

Table 2-2 Network Isolator Intrinsically Safe Wire Connections	
Connector	Connection
1	VIN+ white/blue wire
2	VIN- blue/white wire
3	Net A white/green wire
4	Net B green/white wire

4. The terminals on the network isolator have a plastic cover that needs to be pulled off before making wire connections.

For the easiest method of wiring, pull off the plastic cover, make the connections to terminals 1 and 2, slip the wires that will connect to terminals 3 and 4 through the rectangular opening on the plastic cover and connect them to their respective terminals, and then push the plastic cover back in place.

5. Run the blue with white stripe (blue/white) wire from the DC- connector (marked 11 in our example) on the entity rated power barrier to the VIN+ (terminal 2) on the network isolator.
Run the white with blue stripe (white/blue) wire from the DC+ connector (marked 10 in our example) on the power barrier to the VIN- (terminal 1) on the network isolator.
6. Connect the blue/white wire from the 2151P power supply cable to the DC- terminal on the entity rated power barrier.
7. Connect the white/blue wire from the 2151P power supply cable to the DC+ terminal on the entity rated power barrier.
8. Connect the green with white stripe (green/white) wire from the 2151P power supply cable to Network B (terminal 4) of the network isolator.
9. Connect the white with green stripe (white/green) wire from the 2151P power supply cable to Network A (terminal 3) of the network isolator.
10. The two orange and white wires are not used, but must be terminated in a dummy barrier.

The shield drain wire must be connected to an I.S. (intrinsically safe) ground in the safe area. The following recommendations supplement but do not replace local code requirements for an I.S. ground:

1. An intrinsically safe ground is to be established at the hazardous barrier interface and insulated from standard equipment grounding.
2. Two redundant earthing cables of 14 AWG or heavier are to connect the intrinsically safe ground to a substantial earth ground connection. In no case will the earthing cable length exceed a resistance of 1 Ohm.
3. Labels reading "Safety Earth For Intrinsically Safe Circuits. Do Not Remove" are to be affixed at each end of both earthing cables for the intrinsically safe ground.

**2.4.2 Making
 Non-intrinsically Safe
 Wire Connections**

Specific connections for non-intrinsically safe wiring and equipment will vary, depending on your particular site setup. The connections described below pertain to the example shown in Figure 2-6.

The AC Power Source wires are connected to the top terminals (line voltage, earth ground, and neutral) of the entity rated power barrier (our example shows a Stahl power isolator).

Non-intrinsically safe terminal connections for the power barrier are shown below in Table 2-3.

Table 2-3 Entity Rated Power Barrier Non-Intrinsically Safe Wire Connections	
Connector (on Stahl power isolator)	Connection
L	line voltage wire
	earth ground wire
N	neutral wire

Terminal connections for the network isolator (P/N 60-2004-224) are printed on its side label. The non-intrinsically safe connections are shown below in Table 2-4.

Table 2-4 Network Isolator Non-Intrinsically Safe Wire Connections	
Connector	Connection
5	Net A white/green wire
6	Net B green/white wire
7	DC+ white/blue wire
8	DC- blue/white wire

For the easiest method of wiring, pull off the plastic cover, make the connections to terminals 7 and 8, slip the wires that will connect to terminals 5 and 6 through the rectangular opening on the plastic cover and connect them to their respective terminals, and then push the plastic cover back in place.

Connections and equipment on the non-intrinsically safe side will vary, depending on your particular setup. You will need to provide a power supply; Teledyne Isco has a DIN mounted power supply available (P/N 341-0002-18). Make sure you have lengths of wire of the correct type and length to make any necessary connections. If you have any questions regarding connections at your site, contact Teledyne Isco's technical service department.

If you are using a 2108 module as shown in our example, specific connections will vary, depending on the equipment you are attaching to the 2108 (power source, 2100 series modules).

The connections will be similar to the drawing in Figure 2-7, in that:

- a. white/green wire will be connected to Network A (terminal 4) on the 2108 terminal strip
- b. green/white wire will be connected to Network B (terminal 5)
- c. white/blue wire will be connected to terminal 1
- d. blue/white wire will be connected to terminal 2

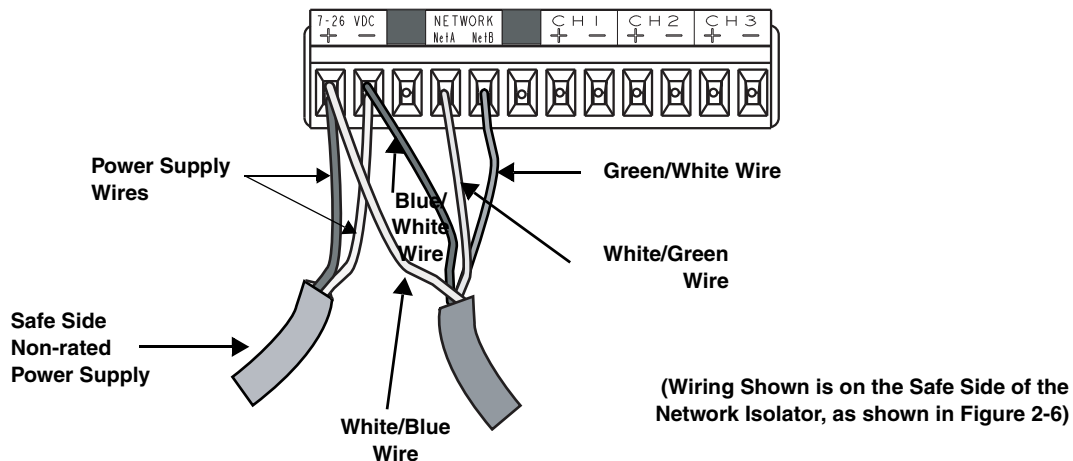

Figure 2-7 Terminal Connections to the 2108

2.4.3 Connecting Using a Communication/Barrier Cable

In addition to the example given in Figure 2-5, there are other ways to connect to the 2151P.

The 2151P has a communication connector on the top (see Figure 1-2). This provides one way that the 2151P can be connected to a laptop computer (see Figure 2-8) or an Isco 2101 Field Wizard or 2103 Modem (Figure 2-11) running Isco's Flowlink software.

The connection is made using a special intrinsically safe communication barrier cable. A laptop is connected using cable P/N 60-2004-153; a 2101 or 2103 is connected using cable P/N 60-2004-201. The laptop (or 2100 series module) is located in a safe area, outside of the hazardous location.

The steps that follow tell you how to connect the communication/barrier cable. Refer also to the installation examples and photographs in this section, and to the control drawing in Figures 2-3 and 2-4.

 **WARNING**

All installations in areas that are rated as hazardous locations must conform to the 2151P installation control drawing P/N 60-2003-227, as shown in Figures 2-3 and 2-4.

To connect the communication/barrier cable:

1. Remove the protective cap from the communication connector on the top of the 2151P module.
2. Store the protective cap in the holder next to the connector.
3. Push the hazardous area (6-pin) end of the cable onto the communication connector on the top of the 2151P module.
4. Route the communication cable as shown in Figure 2-8, so that the communication barrier is in a safe area.
5. Depending on which cable you are using, attach the safe area end of the cable to the appropriate port on your computer, or the lower communication connector on the Field Wizard or 2103 Modem.

 **Note**

You can safely connect and disconnect the communication/barrier cable without removing the 2151P Area Velocity Flow System from the hazardous area.

When the communication connector is not in use, it should always be capped to prevent corrosion and improve communications. When the communication connector is in use, store the cap on the holder next to the connector.

 **CAUTION**

Caps **PUSH ON** and **PULL OFF**. Do not rotate the caps to remove them from the connectors.

Example Using a Laptop
Computer

Figure 2-8 shows how the 2151P would be directly connected to a laptop computer.

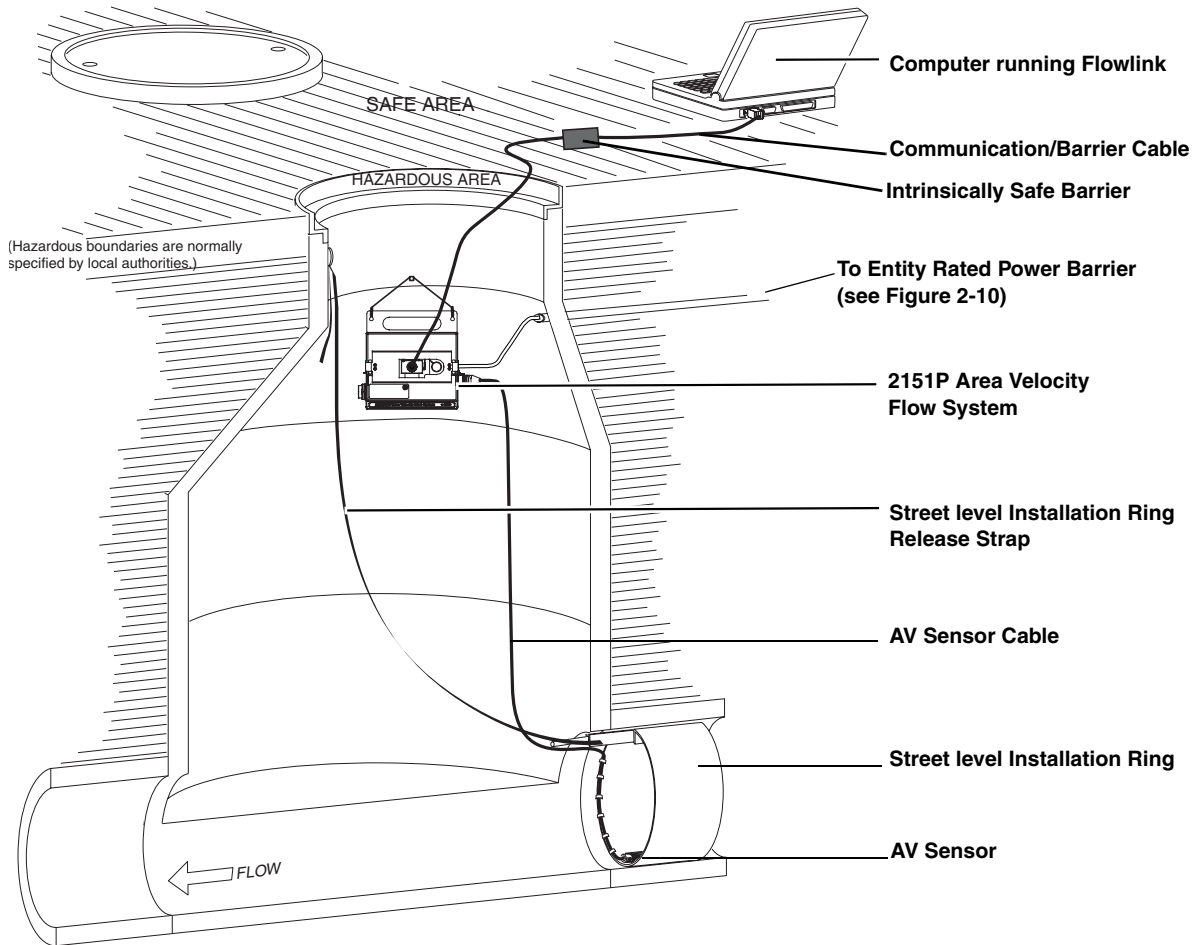

Figure 2-8 Typical Round-pipe Installation
Connected to a Laptop Computer With Cable
P/N 60-2004-153

WARNING

All installations in areas that are rated as hazardous locations must conform to the 2151P installation control drawing P/N 60-2003-227, as shown in Figures 2-3 and 2-4.

When connecting the 2151P directly to a laptop computer, as shown in Figure 2-8, you must use a special communication cable (P/N 60-2004-153) that includes a communication barrier (Figure 2-9).

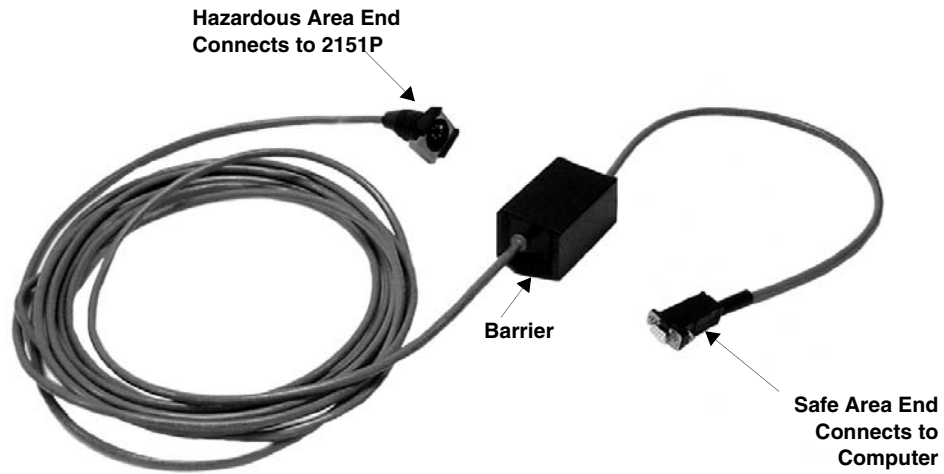

Figure 2-9 Intrinsically Safe Communication/Barrier Cable For Connection to a Computer

The 2151P power supply cable must be connected to an entity rated power barrier in a safe area (Figure 2-10).

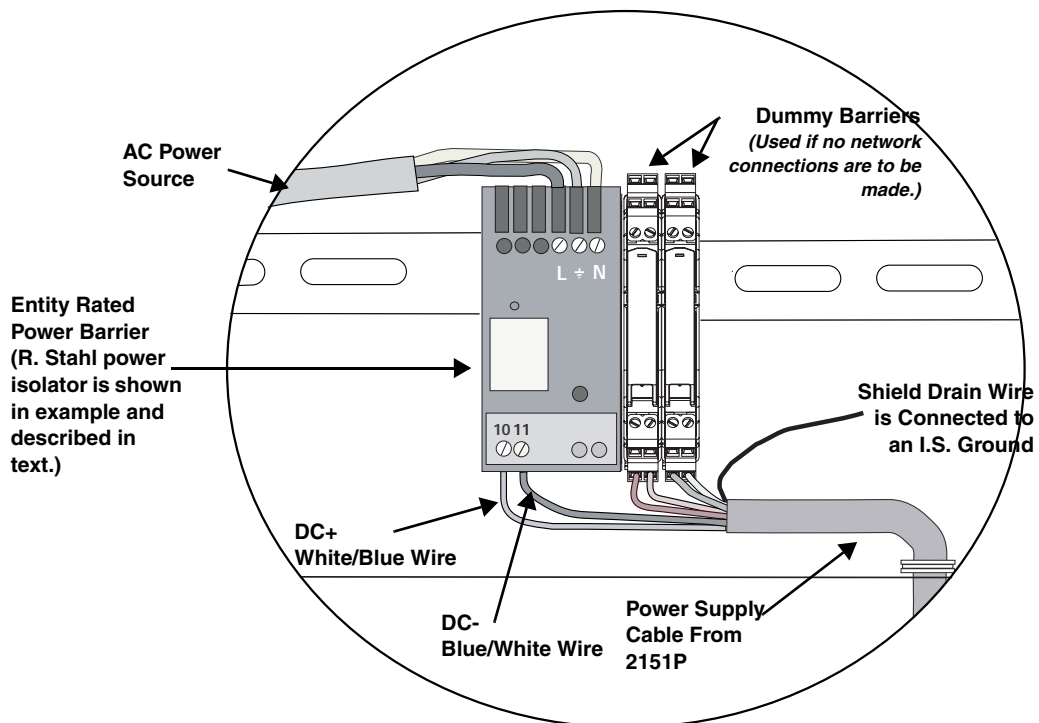

Figure 2-10 Entity Rated Power Barrier Connections When 2151P is Connected to a Laptop Computer Using Cable P/N 60-2004-153

The 2151P power supply cable has six wires plus a shield drain wire. Power to the 2151P must be routed through an entity rated power barrier (our example in Figure 2-10 shows a Stahl power isolator).

1. Connect the blue/white wire to the DC- connector (marked 11 in our example) on the entity rated power barrier.
2. Connect the white/blue wire to the DC+ connector (marked 10 in our example) on the power barrier.
3. **If no network connections are required**, as in our example, terminate the four other wires (green/white, white/green, orange/white, and white/orange) in dummy barriers.

The shield drain wire must be connected to an I.S. (intrinsically safe) ground in the safe area. The following recommendations supplement but do not replace local code requirements for an I.S. ground:

1. An intrinsically safe ground is to be established at the hazardous barrier interface and insulated from standard equipment grounding.
2. Two redundant earthing cables of 14 AWG or heavier are to connect the intrinsically safe ground to a substantial earth ground connection. In no case will the earthing cable length exceed a resistance of 1 Ohm.
3. Labels reading “Safety Earth For Intrinsically Safe Circuits. Do Not Remove” are to be affixed at each end of both earthing cables for the intrinsically safe ground.

The AC Power Source wires are connected to the top terminals (L, ground, and N) on the power barrier.

Example Using a 2101 Field Wizard

Figure 2-11 shows how the 2151P would be connected directly to a 2101 Field Wizard or 2103 Modem module.

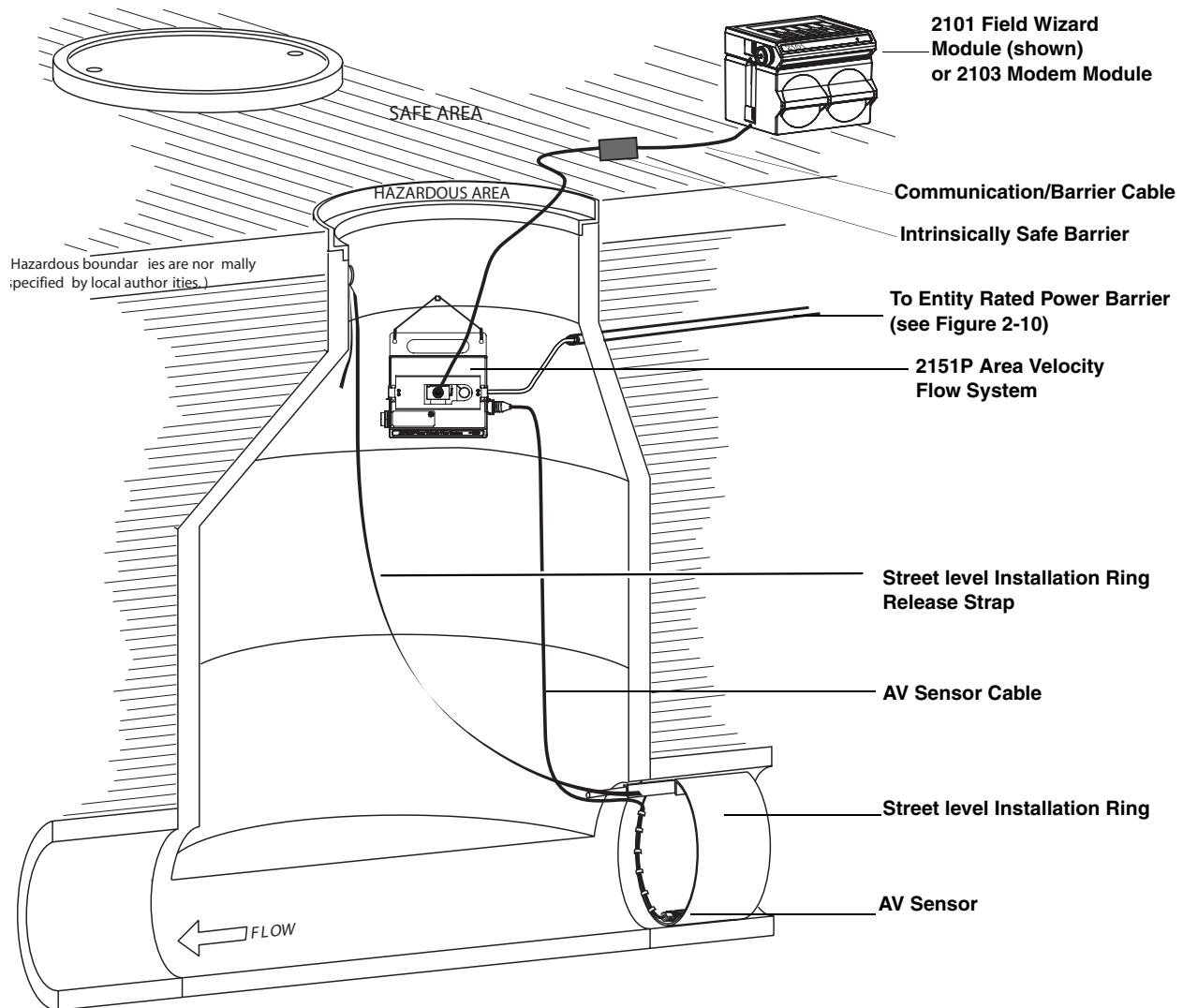

Figure 2-11 Typical Round-pipe Installation
 Connected to a 2101 Field Wizard With Cable
 P/N 60-2004-201

WARNING

All installations in areas that are rated as hazardous locations must conform to the 2151P installation control drawing P/N 60-2003-227, as shown in Figures 2-3 and 2-4.

When connecting to a 2101 or 2103, as shown in Figure 2-11, you must use a special communication cable (P/N 60-2004-201) that includes a communication barrier (Figure 2-12).

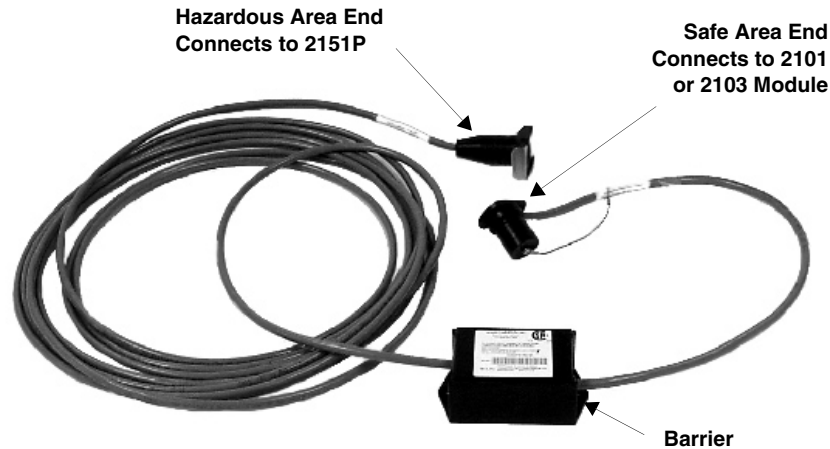

Figure 2-12 Intrinsic Safe Communication / Barrier Cable For Connection to a 2101 or 2103 Module

The 2151P power supply cable must be connected to an entity rated power barrier in a safe area. Refer to the connections shown in Figure 2-6, and the wiring instructions that follow that diagram.

2.5 Connecting to the Isco Quick Disconnect Box

Connecting the 2151P to Isco's Quick Disconnect (QD) Box (P/N 60-2004-228) allows for more convenient installation and removal.



Figure 2-13 Isco's Quick Disconnect Box

As shown in the installation control drawing in Figure 2-3, the QD Box is located in the hazardous area, along with the 2151P. The intrinsically safe power cable on the 2151P is connected to one side of the QD Box. A six conductor cable with shield drain wire (P/N 60-5314-417) is connected to the other side of the QD Box and run to an equipment box where it is wired as shown in Figure 2-3 and discussed in Section 2.4.7.

When wiring the two cables to the QD Box, **make sure that like colors are in contact with each other**, as shown in Figure 2-14.

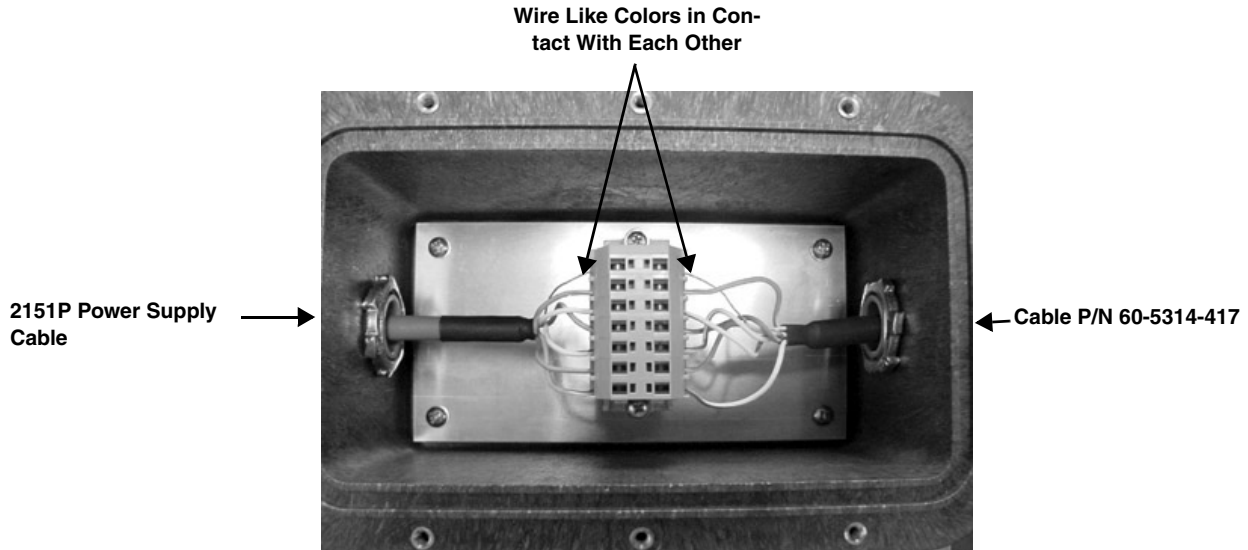

Figure 2-14 Wiring Inside Quick Disconnect Box

2.6 Program the Module

After you have installed the 2151P, and the AV Sensor is installed in the flow stream, the flow stream properties must be defined. To do this, connect to the 2151P Module with *Flowlink for Windows* software and define the stream properties in the 2151P Module's program settings. These ensure that the system correctly reads the liquid level and converts the measured level to flow rate.

Note

The 2151P System requires Flowlink 4.1 or later. Earlier versions do not support 2151P System instruments.

Refer to Section 3 and define the following properties:

- **Level** – Enter a liquid level measurement to calibrate the level readings from the AV Sensor.
- **Zero Level Offset** – If the AV Sensor is not installed in the bottom-center of the channel, an offset distance must be entered.
- **Set Flow Rate to zero if no velocity data checkbox** - Determines how the 2151P Module reports flow rates if stream velocity data is not available.
- **Flow Conversion** – The 2151P Module can store flow rate readings. To correctly convert the measured level and velocity readings to a flow rate, the flow conversion method and channel properties should be defined.

- **Silt Level** – (*Area Velocity Flow Conversion Only*) The 2151P Module can compensate for a build up of silt around the AV Sensor.

These five settings should be considered a minimum requirement. Other settings, such as *Data Storage Rates*, *Site Name*, and *Module Names*, also may be set using Flowlink.

2.7 Mounting Rings

Consult your Isco Mounting Rings instruction manual for detailed hardware information.

The following sections describe sensor installation using the two options available for mounting the AV sensor in pipes or round-bottomed flow streams. For pipes up to 15" (38 cm) in diameter, **stainless steel self-expanding mounting rings (Spring Rings)** are available. For pipes larger than 15" in diameter, Teledyne Isco offers the **Scissors Rings (Universal Mounting Rings)**. Area velocity sensors can also be installed using primary measuring devices.

2.7.1 Spring Rings

To install a spring ring, compress the ring, slip it inside the pipe, and then allow it to spring out to contact the inside diameter of the pipe. The inherent outward spring force of the ring firmly secures it in place. A typical self-expanding mounting ring (with a probe mounted on it) is shown in Figure 2-15.

These mounting rings are available for use in pipes with inside diameters of 15.2 cm (6"), 20.3 cm (8"), 25.4 cm (10"), 30.5 cm (12"), and 38.1 cm (15"). The Isco part numbers for the various size mounting rings available are listed in Appendix B. These part numbers include not only the ring, but also the miscellaneous hardware necessary to mount the sensor on the ring.

Isco spring rings have mounting holes for installing a stainless steel grounding block for the attachment of bonding conductors. Ground lag kit #60-2007-476 ordered separately.

 CAUTION
--

Always wear leather gloves when handling the rings (either type). The metal is finished, but there is still a possibility of cutting your hands on the edges.

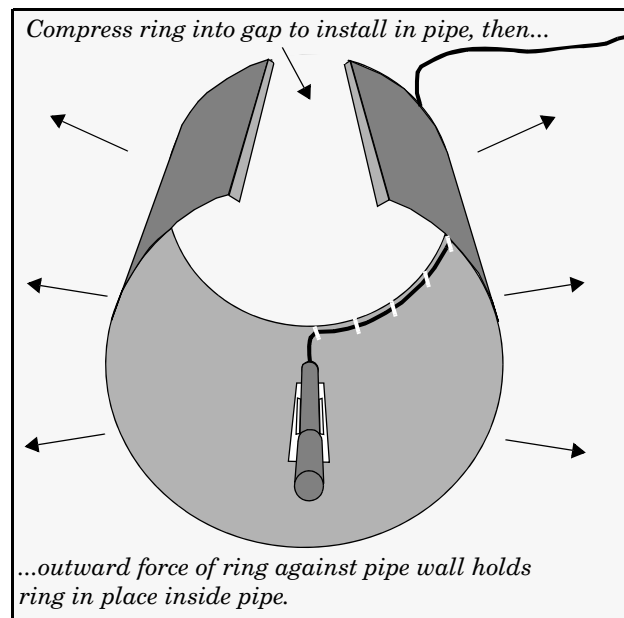

Figure 2-15 Sensor Installed on a Spring Ring

Attaching the Sensor to the Ring

Attach the AV sensor to the ring either by using two 4-40 countersink screws or by snapping the optional probe carrier to the ring. This second method of attaching the sensor allows for easy removal in case service is needed later.

CAUTION

Make sure the slots on the AV sensor carrier are completely pressed into the tabs on the ring. This is particularly important where there is any possibility of reverse flows, or where flows are of high velocity. If the AV sensor is not fully pressed into the mounting ring tabs, it might come loose in the stream, and could possibly be damaged or lost.

Make sure the sensor cable is securely fastened along the back (downstream) edge of the ring. Otherwise, the sensor may provide **inaccurate level readings** under conditions of high velocity.

To complete the sensor-spring ring assembly procedure, attach the sensor cable to the downstream edge of the ring. Follow the cable routing shown in Figure 2-15. Other routing directions may affect measurement accuracy. The cable can actually create a stilling well downstream from the sensor, causing the level to read low. Use the self-locking plastic ties supplied with the ring. Install the ring in the pipe by compressing it. Press inward on both sides and slide the ring into the pipe.

Route the sensor cable out of the stream and secure it in position by placing the ties through the holes in the mounting ring and then locking them around the cable, as shown in Figure 2-15.

 **CAUTION**

Do not overtighten the plastic cable ties; they should be tightened just enough to secure the cable in place, without greatly indenting the cable. Overtightening the plastic ties may collapse the reference tube in the cable, blocking it.

The spring ring may need anchoring. Under conditions of high velocity (greater than 1.5 meters per second or 5 feet per second), the ring may not have sufficient outward spring force to maintain a tight fit inside the pipe. The ring may start to lift off the bottom of the pipe, or may even be carried downstream.

This problem is more prevalent in the larger diameter pipes and in pipes with smooth inside surfaces, such as plastic pipes. If any of these conditions are present, or if movement of the mounting ring is detected or suspected, you must anchor the ring in place. You can do this by setting screws through the ring into the pipe, or by other appropriate means. If there is a problem with the smaller diameter rings, it may be sufficient to simply increase the outward spring force of the ring by bending it into a less round configuration.

2.7.2 Scissors Mounting Ring

For pipes larger than 15" in diameter, Teledyne Isco offers the adjustable Scissors Ring (also known as the Universal Mounting Ring). This device consists of two or more metal strips that lock together with tabs to form a single assembly. There is a base section where the sensors are mounted, two or more extension sections (usually), and a scissors section at the top that expands the entire assembly and tightens it inside the pipe. The scissors section contains a long bolt that increases the length of the section as it is tightened.

The assembled scissors rings fit pipe diameters from 16" to 80". Secure the unit in place by tightening the scissors mechanism with a $\frac{5}{8}$ " socket wrench or other suitable tool. Ring sections are .040" thick half-hard 301 stainless steel sheet. All other parts are also stainless steel, except for the plastic cable ties in the hardware kit.

Each extension, 1, 2, 3, and 4, adds 9.0", 21.5", 31.5", or 41.5", respectively, to the circumference of the ring. Used alone, the base section fits a pipe that is approximately 16" to 19" in diameter. The 9.0" (smallest) extensions can be used to take up or remove slack, to bring the scissors mechanism into a position where it can be effectively tightened.

 **Note**

The hardware kit includes flat head bolts and nuts. Teledyne Isco strongly recommends bolting the assembled scissors ring together before installation, using the holes provided for that purpose. Bolting the tongue sections together can greatly increase safety and prevent the assembly from being torn apart.

Do not overtighten the mechanism. It is designed to flex somewhat to provide a positive lock, once moderately tightened. For installations in larger channels and/or high flow, extensions 2, 3, and 4 have slots for attaching the ring to the channel wall using appropriate anchoring hardware.

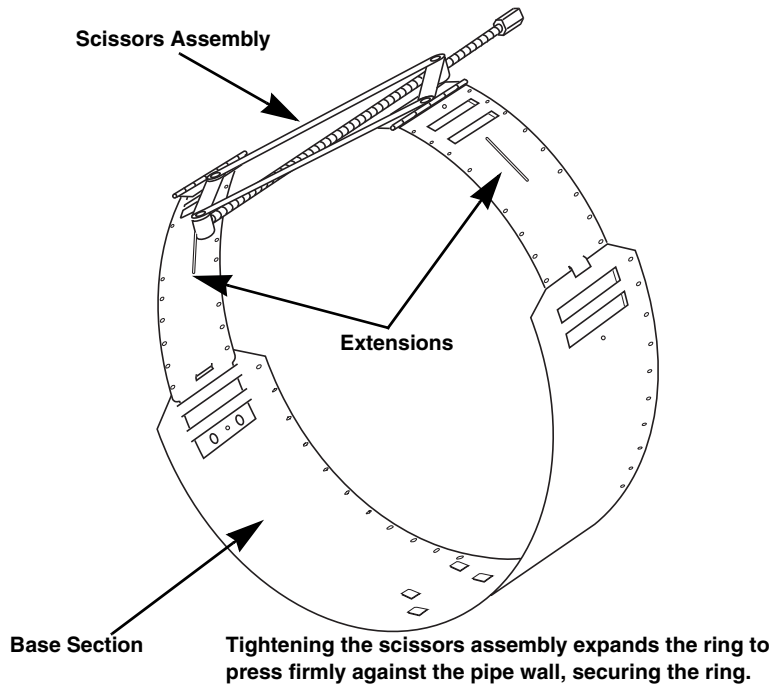

Figure 2-16 Scissors Ring adjustment

To prevent debris from catching on the probe cable, it is important to attach the cable to the mounting ring so it offers as little resistance to the flow as possible. Attach the sensor cable to the downstream edge of the ring, using the self-locking plastic ties supplied with the ring. Place the ties through the holes in the mounting ring and then lock them around the cable.

CAUTION

Do not overtighten the plastic cable ties; they should be tightened just enough to secure the cable in place, without greatly indenting the cable. Overtightening the plastic ties may collapse the reference tube in the cable, blocking it.

2.7.3 Completing the AV Sensor Installation

The AV sensor installation is finished by securing any excess sensor cable using cable clamps or other means.

The reference tube inside the cable can be restricted or blocked if the cable is kinked, sharply bent, coiled, or otherwise pinched. The sensor cable should be handled and mounted with care. Also, if there is any appreciable distance between the point where the sensor cable leaves the mounting apparatus and the location of the flow meter, *be sure* to attach the cable to the flow stream wall to prevent it from vibrating, moving around, tangling, or possibly collecting debris.

 **WARNING**

Do not coil the sensor cable. This will form an inductor and create a hazard.

 **CAUTION**

Under no circumstances should you leave any extra length of sensor cable dangling freely in the flow stream where it could trap debris or become tangled.

Use gloves and eye protection when assembling and installing the rings in a pipe. Though deburred, the edges of the stainless steel can cut if improperly handled. *Please read the information in the Isco Mounting Rings Manual on how best to install this device.*

Observe general safety procedures when entering any manhole. See “General Safety Procedures” in the back of this manual for more information on general hazards and necessary precautions.

2.8 Final Installation Check

The system should be secured at the site. This prevents damage caused by accidental falls and from being swept away if the channel is flooded. In manholes, the module is often secured to a ladder rung. Teledyne Isco's Customer Service Department or your local representative can assist you with installation options.

As you complete the installation, the following should be checked before leaving the site unattended:

1. The module should be positioned where it will be protected from submersion. Should the module become submerged, level readings may drift and the hydrophobic filter will seal to protect the reference air line.

 Note

To protect the Flow module and AV sensor, the hydrophobic filter seals off the reference air line when it is exposed to excessive moisture. When sealed, the filter prevents irreparable damage, yet may cause the level readings to drift. This single-use filter must be replaced once it becomes sealed.

2. Make sure all of the protective caps are in place. An unused upper communication connection must be capped to prevent damage and terminate the communication line. If the communication connector is in use, its cap should be properly stowed. Like the module and sensor connections, the protective caps and their O-rings should be cleaned and coated with a silicone lubricant. Damaged O-rings must be replaced (part #202-1006-69).
3. Carefully route cables. Protect them from traffic in the area. Avoid leaving excess AV Sensor cable in the flow stream where it may collect debris.

2151P Area Velocity Flow System

Section 3 Programming

3.1 Section Overview

This section describes how to set up the operation of a 2151P Area Velocity Flow System using Isco's Flowlink for Windows software.

 **Note**

The 2151P System requires Flowlink 4.1 or later. Earlier versions do not support 2151P System instruments.

Flowlink Help

Detailed Flowlink instructions are beyond the scope of this manual. Flowlink's operating instructions are available in a Windows Help format. You can access the help topics for an active window by clicking on its *Help* button or by pressing F1 on your computer's keyboard. You can also access Help topics from a Contents and Index window (HELP>CONTENTS AND INDEX from the Flowlink menu).

3.2 Flowlink Connections

The 2151P AV Flow System can be connected to a laptop, an Isco 2103 Modem module, or an Isco 2101 Field Wizard module. (Instructions for the 2103 and 2101 can be found in their respective user manuals.)

Detailed installation instructions can be found in Section 2 of this manual.

 **CAUTION**

The 2151P MUST be installed in accordance with the approved control drawing P/N 60-2003-227 found in the Important Safety Information insert at the beginning of this manual and shown in Figures 2-1 and 2-2.

3.3 Program Settings

An easy way to begin Flowlink communications with the site is to *Quick Connect*. As a default Flowlink setting, the Quick Connect dialog box opens when you start Flowlink. Click on the large *2100 Instruments* button to connect. Flowlink will read the 2100 system information and try to match it with an existing site in the open database. If Flowlink cannot find a match for the connected site, it creates a new site in the database.

While connected, Flowlink displays the *Site View* window. This window contains all of the program settings that control the site's operation. The settings are grouped, or categorized, using five tabs: Measurements, Site Info, Modules, Data Storage, and a variable tab used to set up the various measurement types.

Essential Settings

Some program settings are essential to the operation of an 2151P and its attached AV Sensor. Five program settings should always be verified when you are setting up a new site:

- **Level** – Enter a liquid level measurement to calibrate the level readings from the AV Sensor (3.3.1).
- **Zero Level Offset** – If the AV Sensor is not installed in the bottom-center of the channel, the distance the AV Sensor is offset must be entered (3.3.2).
- **Set Flow Rate to zero if no velocity data checkbox** - Determines how the AV Module reports flow rates if stream velocity data is not available (3.3.3).
- **Flow Conversion** – The 2151P can calculate flow rate readings. To correctly convert the measured level and velocity readings to a flow rate, the flow conversion method and channel properties should be defined (3.3.4).
- **Silt Level** – The 2151P can compensate for a buildup of silt around the sensor (3.3.5).

These five program settings directly affect the data collection. Incorrect settings may introduce errors in the measured data, many of which may prove to be difficult to correct afterwards.

Data Storage Settings

You should also check the Data Storage Rates while you are reviewing the program settings. You can view the storage rates on the Data Storage tab to ensure that pertinent types of data are being stored, and that the rates will provide a sufficient amount of data for your application. Refer to section 3.3.6 for instructions on how to modify the data storage rates.

General Settings

Once the site’s communication has been resolved, the Site and Module Names may be changed to help you better manage the sites and data collection. Giving sites descriptive names such as “12th and Main Streets” can help you easily recognize the measurement locations, instead of generic terms such as “Site 1.” Site and Module Names are discussed in sections 3.3.7 and 3.3.8.

Changing a Setting

After modifying a setting as described in sections 3.3.1 through 3.3.8, click on the APPLY button (or press F9 on your keyboard). Flowlink sends the change to the module and updates the site’s settings in its Flowlink database.

3.3.1 Level

A measurement of the actual liquid depth should be taken to calibrate the level readings. The value of this measured depth should be entered on the *Level* measurement tab in Flowlink.

 **Note**

Before calibrating the level, allow a newly installed AV Sensor to stabilize under the stream conditions. If the sensor undergoes wide temperature variations between its storage and operating environments, it may take several minutes to stabilize.

Measurement Location

The location of your measurements can affect the flow conversion results. An understanding of how the AV Sensor measures level and velocity will help you determine where the measurements should be taken.

The AV Sensor transmits an ultrasonic sound wave. It propagates from the front of the sensor in a cone-shaped pattern. From within this cone, the AV Sensor measures the stream velocity. Therefore, your level measurement should be taken from a point inside the cone. Since this cone cannot be seen, a general rule is to measure in front of the sensor along the channel centerline at a distance equal to the liquid depth. For example, if the stream is one foot deep, take the level and channel dimension measurements one foot upstream from the sensor. If the flow at this point is turbulent, consider relocating the sensor.

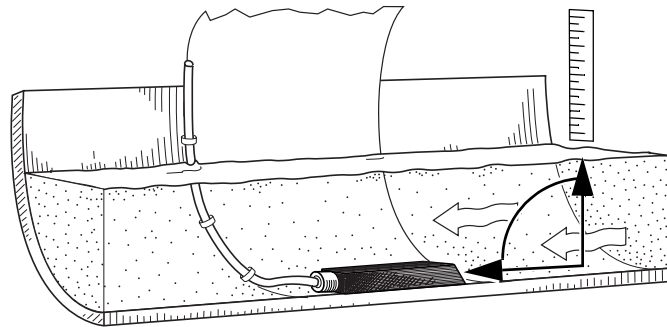
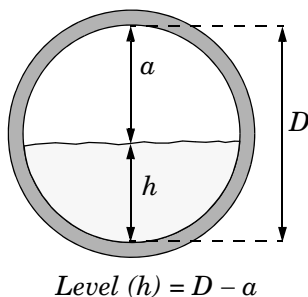

Figure 3-1 Preferred Measurement Location

Do not measure the level and channel dimensions right at the sensor, as the sensor and the mounting ring may cause a slight “jump” or localized rise in the level. At very low levels and high velocities, this jump in the liquid surface may become quite significant.



In round pipes it is possible to measure the level without disturbing the stream surface. This method is preferred. Refer to the diagram in the margin. First measure the inside diameter of the pipe (D). Then measure the airspace (a) from the liquid surface to the peak of the inside diameter. Average this measurement if the surface is not calm. The level measurement that you enter (h) is calculated by subtracting the distance above the liquid (a) from the diameter (D). If difficult channel conditions keep you from making the measurements as described above, another site should be considered.

3.3.2 Zero Level Offset

AV Sensors are sometimes offset in the channel to avoid heavy concentrations of silt, or to maximize the level resolution over a specific range. When the AV Sensor is offset, an offset distance must be entered on the *Velocity* measurement tab in Flowlink.

Refer to Figure 3-2. Enter a value for the vertical distance the sensor is installed above the true zero level of the stream. For example, if the sensor is mounted on the side of the pipe two inches higher than the true zero level (the bottom center of the pipe), the Zero Level Offset is two inches. If the sensor is mounted at the bottom of the channel, enter zero.

Note

Do not confuse the circumferential distance between true zero and the location of the AV Sensor with the vertical distance (height). If you install the AV Sensor at the true zero level of the pipe or channel, you would enter “0” for the offset (ignoring the thickness of the mounting ring).

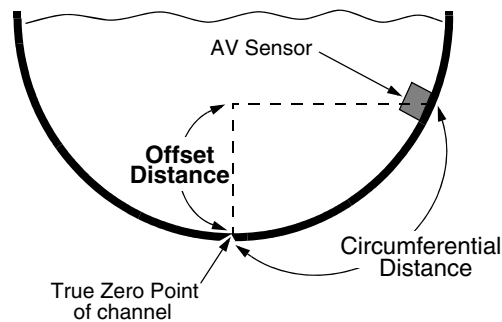

Figure 3-2 Zero Level Offset Measurement

3.3.3 No Velocity Data and Flow Rates

Occasionally velocity readings are lost because either a flow stream does not contain enough reflective particles, or the sensor is covered with silt. These lost velocity readings are logged as a “No Data Code.” If the 2151P is set up to use area velocity flow conversion, it is then unable to calculate the flow rate. You can control how the Flow Rate readings will be reported during these conditions with the “Set flow rate to zero if no velocity data” checkbox, found on Flowlink’s *Velocity* measurement tab.

- Checked, the 2151P stores the flow rate as 0.0 when velocity data is not available.
- Unchecked, the 2151P will use the last valid velocity measurement in the flow rate calculation.

Note

Measuring velocity becomes extremely difficult at low liquid levels. When the level falls below one inch, the module no longer measures the velocity. Instead, velocity is extrapolated based on measurements that occurred between one and seven inches of liquid.

3.3.4 Flow Conversion

The 2151P is capable of determining flow rates using either area velocity conversion or level-to-flow rate conversion. Table 3-1 lists the available flow conversion methods.

The 2151P is capable of calculating and storing any two conversion methods simultaneously. Flow conversions are defined on the *Flow Rate* and *Flow Rate 2* measurement tabs in Flowlink. To do this, select the *Conversion Type* that matches your application, then enter the required parameters in the fields to the right of the selected conversion type.

Table 3-1 Flow Conversion Methods			
Conversion Type		Device, Formula, or Table	Size or Parameters
Area Velocity	Channel Shape	Area × Velocity	Round Pipe, U-Channel, Rectangular, Trapezoidal, Elliptical
	Level-to-area Data Points	User-developed Table	3 to 50 data points
Level to Flow	Weir	V-Notch Weir	22.5, 30, 45, 60, 90, 120 degrees
		Rectangular Weir with end contractions	Crest Length
		Rectangular Weir without end contractions	Crest Length
		Thel-Mar	6, 8, 10, 12-14, 15-16 inches
		Cipoletti Weir	Crest Length
	Flume	Parshall Flume	1, 2, 3, 6, 9 inches 1, 1.5, 2, 3, 4, 5, 6, 8, 10, 12 feet
		Palmer-Bowlus Flume	4, 6, 8, 10, 12, 15, 18, 21, 24, 27, 30, 48 inches
		Leopold-Lagco	4, 6, 8, 10, 12, 15, 18, 21, 24, 30 inches
		“HS” Flume	0.4, 0.6, 0.8, 1.0 feet
		“H” Flume	0.5, 0.75, 1, 1.5, 2, 2.5, 3, 4.5 feet
		“HL” Flume	4.0 feet
		Trapezoidal Flume	Large 60-degree V Extra Large 60-degree V 2-inch, 45-degree WSC 12-inch, 45-degree SRCRC
	Flow Metering Insert	V-notch	6, 8, 10, 12 inches
		Round Orifice	6, 8, 10, 12 inches
	Manning Formula	Round Pipe	Slope, Roughness, Diameter
		U-Channel Pipe	Slope, Roughness, Width
		Rectangular Pipe	Slope, Roughness, Width
		Trapezoidal	Slope, Roughness, Bottom Width, Top Width
	Equation	Flow = 0.00*(Head ^{0.00}) + 0.00*(Head ^{0.00})	
	Level-to-Flow Rate Data Points	User-developed tables for level-to-flow rate	3 to 50 data points

If the selected flow conversion requires channel dimensions, actual channel measurements should be taken. Channel measurements are preferred over nominal values. Significant errors

may be introduced if your measurements are inaccurate. The example below illustrates the importance of accurate measurements.

For example:

Nominal Pipe Diameter: 10 inches
Actual Pipe Diameter: 10.25 inches
Level Measured Near Outfall: 2.75 inches
Correct Level Measurement: 3 inches

During programming, you enter 10 inches for the round pipe diameter - from the pipe manufacturer's specification. You also enter the 2.75 inch level measurement taken behind the sensor near an outfall. Although each setting has only a 0.25 inch error, the cumulative flow measurement error may exceed 14%!

Refer to the discussion on *measurement location* in section 3.3.1, and Figure 3-1 to determine where to measure the channel dimensions.

3.3.5 Silt Level

Silting in the flow stream will alter your channel dimensions, affecting the flow rate conversion. To compensate for a buildup of silt, a *Silt Level* value can be entered on the *Flow Rate* measurement tab in Flowlink. Silt level compensation is only available when using Area Velocity flow conversion.

3.3.6 Data Storage Rates

The data storage function of an 2151P can record level, velocity, flow rate, total flow, and input voltage readings. The interval at which the 2151P stores the readings is called the *Data Storage Rate*. The 2151P is shipped with default storage rates of 15 minutes for the level, velocity, and flow rate, and 1 hour for total flow and input voltage readings.

You can modify the data storage rates to log readings at a faster or slower rate. Keep in mind that although the 2151P can store data as fast as 1 reading every 15 seconds, faster storage rates will shorten battery life, increase memory usage, and lengthen *Retrieve Data* (interrogation) times.

You can also create conditional data storage rates. The 2151P can log data at a secondary rate when user-defined conditions have been met. For example, an 2151P can store level readings at a primary rate of 15 minutes, and a secondary rate of 1 minute when the level reading is greater than or equal to 1 foot. Secondary rates allow you to collect detailed data when defined events of interest occur, while reducing power and memory consumption when detailed readings are not needed.

To modify the Data Storage Rates, first click on the *Set Up Data Storage...* button on a measurement tab. Then enter the Primary and Secondary Rate settings on the *Data Storage Setup* window. Repeat this for each measurement type.

3.3.7 Site Name

The module is shipped with a default name so that it can immediately begin to communicate with Flowlink. You can change the site name to a more descriptive name on the *Site Info* tab in Flowlink. Keep in mind that the name must be unique among the other site names in the open Flowlink database.

Site names can be up to 37 characters long. Any character may be used in the name except:

/	forward slash	\	back slash
:	colon	*	asterisk
?	question mark	"	double-quote
<	left angle bracket	>	right angle bracket
	bar	&	ampersand

3.3.8 Module Name

The module is shipped with a default name so that it can immediately begin to communicate with Flowlink. You can change a Module Name to a more descriptive name on the *Modules* tab in Flowlink. Keep in mind that the name must be unique among the other module names connected at that site.

Module names can be up to 37 characters long. Any character may be used in the name, except for those noted in *Site Name*, section 3.3.7.

2151P Area Velocity Flow System

Section 4 Modbus Protocol

Sections 4.1 through 4.5 give an overview of the basic capabilities and operation of Modbus protocol as it applies to Isco 2100 Series flow modules.

For a Glossary of Terms and Common Acronyms, see sections 4.4 and 4.5.

For Modbus technical specifications, turn to section 4.6.

4.1 Introduction

Modbus is a simple command/response mechanism to read from and write to specific memory locations called *registers*. A register is a holding place for a piece of digital information within the equipment. There are three standard protocols for Modbus: Modbus RTU, Modbus TCP/IP, and Modbus ASCII. The Isco 2100 Series devices use Modbus ASCII protocol, the method discussed in this manual. Modbus ASCII has more liberal communication timing requirements. Modbus communication for the Isco 2100 Series provides a standard protocol that can be used to retrieve real-time data from a single module or stack of modules at a site, or multiple sites, over a wide area. The data can be sent to a central computer for display, data collection, or process control.

Modbus implementation is independent of Flowlink and cannot alter the Flowlink-programmed configuration of the module. Modbus cannot be used to retrieve historical data from a module's memory.

Due to the wide variety of configurations that can be made with Modbus, it is impossible to cover every usable application. This section will discuss the overall capabilities and operation of Modbus.

4.2 Operation

There are many standard, third party Modbus drivers and OPC servers that may be used to link a remote Modbus device, such as a 2100 Series module, to SCADA or process control software, such as Wonderware™ or Intellution™. The OPC server communicates with the remote instrumentation and accesses registers. The definition of what information is contained and where (the register number, or address) is decided by the manufacturer (Teledyne Isco).

In a 2100 module, the registers hold, but are not limited to, the current real-time value of the meter's level, velocity, flow, input voltage, temperature, and total flow readings, stored in specified register locations. A list of the 2100 register addresses, and what parameters are held where, is available in section 4.6.

By accessing these registers you can obtain the current value of whatever parameter you desire. The reading(s) can then be displayed or stored wherever you designate as a destination; for example, a process control computer.

 **Note**

Level, flow, velocity, and temperature data is stored in metric units only.

Not all registers are limited to read-only data storage. You can also use some registers for control purposes. For example, by writing a “1” value to register 24 (“Identify Module” register), you will tell a 2100 module to light the LED on the front of the module.

4.2.1 Establishing Communication

There are several different communications protocols supported in the 2100 series that require auto-baud rate detection. Because of this, each time a modbus connection is made, the module uses a polling mechanism to repeatedly send a command until a response is received. It may take up to 20 command retries before the module has identified the baud rate and a response is received.

4.2.2 Module Addressing

When connecting to a site via a Modbus OPC server, you use a dedicated line of communication to that module or stack from the OPC server, which can be a dedicated communications cable (direct connection) or a dedicated phone number (modem).

When you are using a direct connection, you are dedicating a specified COM port on the computer, and that COM port determines the site to which you are connecting.

When you are using a modem, the dedicated line is defined by the site's phone number.

If you connect more than one 2100 Series module at a site, the Modbus OPC server, while using the shared communication line for all of the modules within the network, must have some way to differentiate between the modules. When sending a command to a specific module, the command has an address field. This allows the server software to talk to, as well as control, the specified module, while ignoring other modules in the same stack or site.

Each module capable of Modbus Protocol communication will automatically create its own specific ASCII address within the site, using:

- The model numbers of the modules
- The user-defined module names

4.3 Configurations

A variety of configurations can be made with Modbus, either through direct connection or through a modem.

In the example shown in Figure 4-1, you are direct-connecting a server PC to two individual 2100 sites through Modbus, using the COM ports on the OPC Server, which are directly connected to the remote sites.

Connection to the module is made through the RS-232 communication port on the top of the module.

Note

For low power operation, we recommend connecting the module(s) to the computer using the straight-through cable (Isco part number 60-5314-529), which consumes less power, instead of our standard interrogation cable.

In Figure 4-1, the OPC Server PC must have two COM ports. Modbus requires one COM port each, for direct connection of each 2150.

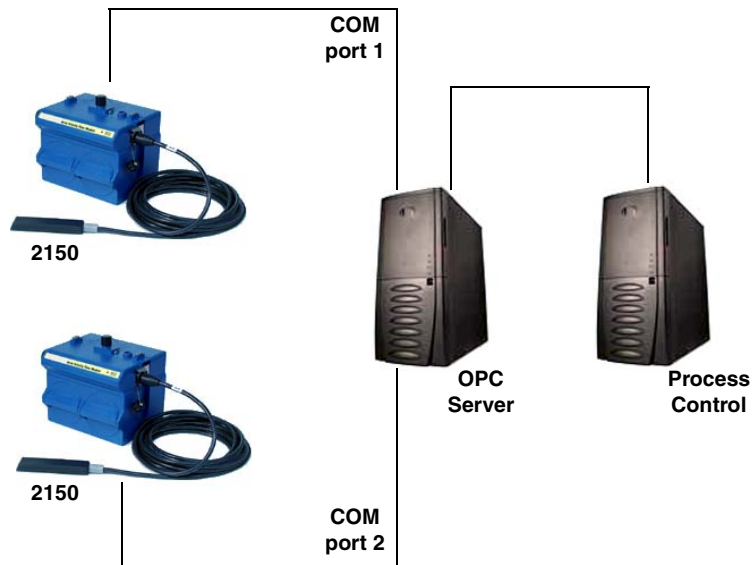

Figure 4-1 Configuration example

The operation sequence for the example above can be summarized in the following steps:

2150:

1. 2150s take readings from probes.
2. 2150s store readings (level, velocity, flow rate, etc.) in their specified registers.

Process Control:

3. The user requests data through Process Control.
4. Process Control asks the OPC server to gather information.

5. OPC connects to the 2150 stack through the cable (direct connection), takes register data from the specified 2150, and populates the OPC server's holding index.
6. Process Control takes data from the OPC server's holding index and gives data to the user.

Note that Process Control can be either manual or automated in this example, and that the OPC server and Process Control may be located physically on the same computer.

4.4 Glossary of Terms

ASCII – Short for American Standard Code for Information Interchange, ASCII is a code that represents English characters with numbers. Most computers represent text with ASCII code, making it possible for one computer or device to share data with another.

2100 modules support Modbus ASCII protocol.

Dedicated Line – A telecommunications path reserved for communication between two specified points and not shared among multiple points.

Modbus Protocol – Modbus Protocol is a messaging structure used to establish master-slave/client server communications between intelligent devices. Modbus is a simple command/response mechanism to read from and write to registers.

OPC – OPC (OLE for Process Control) means open connectivity via open (free for use) standards. It is a series of software standards specifications that fill a need in automation (like printer drivers did for Windows), acting as a translator for data transmission and process control.

The specification defines a standard set of objects, interfaces, and methods for use in process control and manufacturing automation applications to facilitate interoperability. There are hundreds of OPC Data Access servers and clients.

Registers – Registers are locations in memory that have specific data stored for retrieval or are used for control functions. A register is a holding place for a piece of digital information within the equipment. The definition of what is contained and where (the registry number, or address) is decided by the manufacturer (in this case Teledyne Isco).

SCADA – SCADA (Supervisory Control And Data Acquisition) is a computer system for gathering and analyzing real-time data. SCADA systems are used to monitor and control plant operation, or equipment in industries such as telecommunications, water and waste control, energy, oil and gas refining, and transportation.

The SCADA system transfers the information (for example, where a leak has occurred in a pipeline), back to a central site, alerting the home station of the leak, performing necessary analysis and control (such as determining if the leak is critical), and displaying the information in a logical and organized manner.

SCADA systems can be relatively simple, such as one that monitors the environmental conditions of a small office building, or very complex, such as a system that monitors all the activity in a nuclear power plant or a municipal water system.

4.5 Common Acronyms

ASCII – American Standard Code for Information Interchange
DCS – Distributed Control Systems
MTU – Master Terminal Unit
OPC – Object Linking and Embedding (OLE) for Process Control
PLC – Programmable Logic Controller
RTU – Remote Terminal Unit
SCADA – Supervisory Control And Data Acquisition
TCP/IP – Transmission Control Protocol/Internet Protocol

4.6 Register Specifications

All numbers in the Modbus registers are stored most significant byte first. If the polling device has a byte ordering of least significant byte first (an Intel-based PC, for example), the bytes will need to be reversed after they are received.

The Modbus ASCII address is used to index the data by modules. Modbus ASCII address 1 contains information related to the site. The first register contains a 16-bit integer count of the number of modules that have data to report. The maximum number of modules that can be supported is 4.

Modbus ASCII addresses 2 through the number of modules plus 1 contain data from the individual modules.

The Modbus ASCII addresses will be sorted by the model number, and then by module name, which is entered by the user through Flowlink. This allows the user to control the ordering of the addresses and easily predict what data will be in specific registers.

Every measured parameter has a corresponding status and measurement time that are updated with each measurement.

The maximum number of supported measurements from all modules in the system is 28.

The Modbus registers are assigned within 30 seconds after the 2100 module is powered up. To conserve power for the users who do not use Modbus communications, no Modbus registers will be updated with sensor readings until a Modbus master communicates with the 2100 module.

The register definitions for the Site Information device (Modbus ASCII address 1) are in Table 4-1 below:

Table 4-1 Modbus ASCII Address 1 Register Definitions				
Register Number(s)	Name	Data type	Units	Read/Write
1	Number of modules (N) (1-4)	16 bit integer	None	Read
2-20	Site name	38-byte string	None	Read

The register definitions for the individual modules (Modbus ASCII addresses 2-(N+1)) are in Table 4-1 below:

Table 4-2 Modbus ASCII Address 2-(N+1) Register Definitions				
Register Number(s)	Name	Data Type	Units	Read/Write
1-4	Model number	8-byte string	None	Read
5-23	Module name	38-byte string	None	Read
24 ^a	Identify module	16 bit integer	None	Read/Write
25 ^b	Take reading flag	16 bit integer	None	Read/Write
26 ^c	Update interval	16 bit integer	Seconds	Read/Write
27 ^d	Active flag 1	16 bit field	None	Read
28	Active flag 2	16 bit field	None	Read
29	Active flag 3	16 bit field	None	Read
30	Active flag 4	16 bit field	None	Read
40,41	Level	4-byte float	Meters	Read
42	Level status code ^e	16-bit integer		Read
43-52	Level time record	Time ^f		Read
55,56	Velocity	4-byte float	Meters/second	Read
57	Velocity status code	16-bit integer		Read
58-63	Velocity time record	Time		Read
70,71	Flow	4-byte float	Cubic Meters/sec	Read
72	Flow status code	16-bit integer		Read
73-78	Flow time record	Time		Read
85,86	Flow 1	4-byte float	Cubic Meters/sec	Read
87	Flow 1 status code	16-bit integer		Read
88-93	Flow 1 time record	Time		Read
100,101	Volume	4-byte float	Cubic Meters	Read
102	Volume status code	16-bit integer		Read
103-108	Volume time record	Time		Read
115,116	Volume 1	4-byte float	Cubic Meters	Read

Table 4-2 Modbus ASCII Address 2-(N+1) Register Definitions (Continued)

Register Number(s)	Name	Data Type	Units	Read/Write
117	Volume 1 status code	16-bit integer		Read
118-123	Volume 1 time record	Time		Read
130,131	Voltage	4-byte float	Volts	Read
132	Voltage status code	16-bit integer		Read
133-138	Voltage time record	Time		Read
145,146	Temperature	4-byte float	Degrees Celsius	Read
147	Temperature status code	16-bit integer		Read
148-153	Temperature time record	Time		Read
160,161	Internal Temp	4-byte float	Degrees Celsius	Read
162	Internal Temp status code	16-bit integer		Read
163-168	Internal Temp time record	Time		Read
175,176	Analog channel 1	4-byte float	0-100 percent	Read
177	Analog channel 1 status code	16-bit integer		Read
178-183	Analog channel 1 time record	Time		Read
190,191	Analog channel 2	4-byte float	0-100 percent	Read
192	Analog channel 2 status code	16-bit integer		Read
193-198	Analog channel 2 time Record	Time		Read
205,206	Analog channel 3	4-byte float	0-100 percent	Read
207	Analog channel 3 status code	16-bit integer		Read
208-213	Analog channel 3 time record	Time		Read
220,221	Analog channel 4	4-byte float	0-100 percent	Read
222	Analog channel 4 status code	16-bit integer		Read
223-228	Analog channel 4 time record	Time		Read
235,236	Analog channel 5	4-byte float	0-100 percent	Read
237	Analog channel 5 status code	16-bit integer		Read
238-243	Analog channel 5 time record	Time		Read
250,251	Analog channel 6	4-byte float	0-100 percent	Read
252	Analog channel 6 status code	16-bit integer		Read
253-258	Analog channel 6 time record	Time		Read
265,266	Analog channel 7	4-byte float	0-100 percent	Read
267	Analog channel 7 status code	16-bit integer		Read
268-273	Analog channel 7 time record	Time		Read
280,281	Analog channel 8	4-byte float	0-100 percent	Read
282	Analog channel 8 status code	16-bit integer		Read
283-288	Analog channel 8 time record	Time		Read
1765, 1766	Signal strength ^g	4-byte float	0-100 percent	Read

Table 4-2 Modbus ASCII Address 2-(N+1) Register Definitions (Continued)

Register Number(s)	Name	Data Type	Units	Read/Write
1767	Signal strength status code	16-bit integer		Read
1768-1779	Signal strength time record	Time		Read
1780, 1781	Spectrum strength ^g	4-byte float	0-100 percent	Read
1782	Spectrum strength status code	16-bit integer		Read
1783-1794	Spectrum strength time record	Time		Read
1795, 1796	Spectrum ratio ^g	4-byte float	0-100 percent	Read
1797	Spectrum ratio status code	16-bit integer		Read
1798-1809	Spectrum ratio time record	Time		Read

- a. A write to the Identify module register will cause the module to perform the identify operation which may be a steady LED for a few seconds or a beep in the Field Wizard.
- b. Setting the Take Reading flag to 1 will cause the module to update the registers with current data readings. It will be set to zero when the readings have all been updated. This may be used to initiate readings and poll for when they are ready to be read. It may take up to 50 seconds to update all the readings, depending upon the flow conditions. Setting the Take Reading flag to 2 causes an automatic, 15 second update of readings when a Modbus master is polling the 2100.
- c. The Update Interval specifies an interval in seconds that the registers are automatically updated. It defaults to zero, which indicates that no automatic updating will occur.
- d. The Active Flag (1-4) bit fields specify what fields/registers are active in the list. This provides support for a maximum of 64 fields. For example, if bit 0 of register 27 is set, the Level (registers 40,41) is active. If bit 1 of register 27 is set, then the Velocity (registers 55,56) is active. If bit 0 of register 28 is set, the Analog channel 7 (registers 265,266) is active.
- e. A non-zero status code indicates a measurement problem.
- f. Time is represented in a series of registers: Order is from lowest address to highest - Seconds (0-59), Minutes (0-59), Hours (0-23), Days (1-31), Month (1-12) and Year (1977-2099).
- g. Optional software feature. Contact Teledyne Isco to order enable code for the module used for communication.

Table 4-3 2100 Measurement Parameters by Model Number*

2103, 2103c/g, 2105, 2105c/g	2108	2110	2150, 2151, 2151P
Voltage	Analog channel 1	Level	Level
	Analog channel 2	Flow	Velocity
	Analog channel 3	Volume	Flow
		Voltage	Flow 1
		Temperature	Volume
			Volume 1
			Voltage
			Temperature
			Signal strength
			Spectrum strength
			Spectrum ratio

*Single module only; does not include any additional connected devices. Subject to change.

2151P Area Velocity Flow System

Section 5 Maintenance

5.1 Maintenance Overview

This section explains the maintenance requirements of the 2151P Area Velocity Flow System and its AV Sensor.

The 2151P System is designed to perform reliably in adverse conditions with a minimal amount of routine service requirements. To keep your system working properly, the following should be checked at regular intervals:

- Desiccant (Section 5.3)
- Channel conditions (Section 5.4)

Maintenance intervals are affected by many variables. The Data Storage Rate and type of sensor will all affect the battery life. Humidity levels obviously affect the service life of the desiccant, and the amount of debris in the stream can drastically alter the channel conditions.

As a guide, a basic system installed in an environment with moderate humidity levels and an AV Sensor installed in a channel relatively free from debris and silt, the maintenance interval should not exceed three months. A basic system is defined as a 2151P Module and AV Sensor recording readings at the default intervals of 15 minutes.

Experience is often the best tool to use when establishing minimum maintenance intervals for your system. Until you have gained an understanding of the 2151P Module's operation under differing environmental conditions, a weekly maintenance interval is recommended.

5.2 Maintenance Kit

Teledyne Isco, Inc.
Customer Service Dept.
P.O. Box 82531
Lincoln, NE 68501 USA
Phone: (800) 228-4373
(402) 464-0231
FAX: (402) 465-3022
E-mail:
IscoCSR@teledyne.com

A maintenance kit (P/N 60-2009-005) supports the 2151P Module, and contains O-rings for the connectors and desiccant cartridge, a hydrophobic filter, and a one-pound container of indicating silica gel desiccant. You can order the kit by calling Teledyne Isco's Customer Service Department.

5.3 Desiccant Maintenance

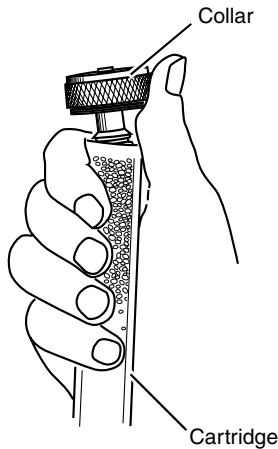

5.3.1 Reactivating the Desiccant

The 2151P System uses desiccant to protect the internal components from moisture damage. In the 2151P module, a desiccant cartridge is used to dry the reference air for the sensor. This prevents moisture from plugging the reference line, which would cause the sensor to report erroneous level readings. The cartridge is filled with indicating silica, which is blue or yellow when dry. As the desiccant becomes saturated, the color changes from blue to pink, or from yellow to green. Replace the desiccant before the entire length of the cartridge turns pink or green.

The desiccant is contained in a cartridge located on the left side of the 2151P module. To remove the cartridge, unscrew the collar and slide the cartridge out of the 2151P. The clear tube reveals the silica gel desiccant inside.

To replace the silica gel desiccant:

1. Hold the cartridge upright with the collar at the top.
2. As shown in the margin, push the collar off the cartridge.
3. Empty the saturated silica gel beads or granules.
4. Fill the tube with new (Isco P/N 099-0011-03) or reactivated (see section 5.3.1) silica gel desiccant.
5. Press the collar onto the tube.
6. Slide the cartridge into the 2151P. Tighten the collar to seal the cartridge in place.

Silica gel beads and granules of desiccant can be reactivated.

 CAUTION
--

Desiccant may produce irritating fumes when heated. Observe the following precautions:

- Use a vented oven in a well-ventilated room.
- Do not remain in the room while the regeneration is taking place.
- Use the recommended temperature. Avoid heating the desiccant at higher than recommended temperatures.

Irritating fumes can come from the desiccant during reactivation, and you should use caution. Material Safety Data Sheets are in the back of this manual.

The desiccant's ability to remove moisture may lessen with each saturation/reactivation cycle, resulting in a need for more frequent service. After several cycles, the desiccant may no longer be effective as it saturates too quickly. At this point, replace the desiccant.

To reactivate the silica gel desiccant, pour the spent desiccant into a heat resistant container. Never heat the cartridge assembly; it will melt. Heat the silica gel in a *vented convection oven* at 212° to 350°F (100° to 175°C) for two to three hours, or until the blue or yellow color returns. Allow the desiccant to cool and store it in an airtight container until ready for use.

5.4 Channel Conditions

Because the sensor body offers a streamlined profile to the flow, solid materials rarely collect on the sensor. However, clean the channel upstream and downstream from the sensor periodically. This maintains the hydrostatic conditions on which the level-to-area conversion is based.

5.5 Other Maintenance

Other maintenance may be performed on the 2151P Module and sensor “as-needed.” Sections 5.5.1 through 5.5.3 describe these activities.

5.5.1 Hydrophobic Filter



209-0093-93

If the 2151P Module is in a humid location or submerged, a hydrophobic filter prevents water from entering the desiccant cartridge and reference line. Any amount of water will plug the filter and it must be rinsed with clean water and allowed to dry, or replaced so that the reference line can be reliably ventilated. *Drifting level readings are often an indication that the hydrophobic filter may be plugged.*

Remove the hydrophobic filter with a $\frac{5}{8}$ " or 16mm socket. Gently screw the replacement filter (Isco part #209-0093-93).

If the hydrophobic filter frequently requires replacement, consider relocating the modules so that they are better protected.

5.5.2 Cleaning

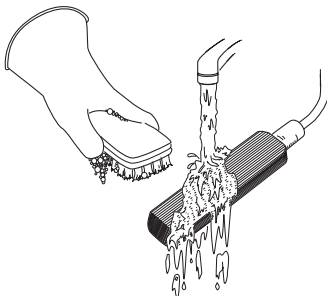

Gently flush diaphragm cover with water.
No tools!

Ports

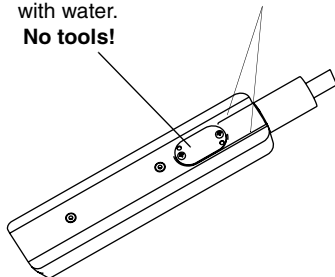

The 2151P Module case may be cleaned with mild detergent and warm water. Before cleaning the module, ensure that all protective connector caps are in place.

The cable and outer surfaces of the AV Sensor may also be cleaned with mild detergent and warm water.

If the flow stream carries a great deal of debris, beware of organic materials that may collect beneath the AV Sensor. This material swells as it becomes saturated with water and may exert pressure on the outer diaphragm. This can damage the transducer and permanently disable the AV Sensor. Keeping the ports clean not only prevents damage, but assures you that the AV Sensor will respond to the hydrostatic pressure above instead of the pressure created by swollen material.

If the ports become blocked:

1. Remove the sensor from its mounting ring, plate, or carrier.
2. Scrape any accumulated solids off the exterior of the sensor. Use a brush and flowing water.
3. Remove debris that has accumulated in the ports.
4. The outer diaphragm is behind the small round cover on the bottom of the sensor. It should be visible through the two small openings at the center of the cover. Gently flush the cover and holes with water to remove debris.

CAUTION

Avoid using tools near the cover openings. The transducer is extremely sensitive to pressure applied to its exposed surface. Direct or indirect contact with the outer diaphragm may permanently damage the AV Sensor.

5.5.3 Sensor Cable Inspection

Erroneous level or velocity readings may not always indicate a fault inside the AV Sensor body. A damaged cable can affect the operation of the sensor, particularly if the reference air tube inside the cable is collapsed or blocked. Damaged cables cannot be spliced or repaired.

If the AV Sensor cable is damaged, you must replace the entire assembly, as the sensor body and cable are a factory-sealed unit. Keep the connector clean and dry and install the cable so that it is not at risk of damage resulting from other activity taking place in the area. The connector can be replaced in some instances, depending on the condition of the cable.

In temporary installations, do not leave cables lying where they may be stepped on or run over by heavy equipment. Do not leave extra cable loose in the flow stream where it can trap debris.

In permanent installations, cables repeatedly subjected to abuse will fail and should be installed in conduit for protection. The conduit must be large enough to pass the connector through, as you cannot remove or replace it.

5.6 How to Obtain Service

Teledyne Isco, Inc.
Technical Service Dept.
P.O. Box 82531
Lincoln, NE 68501 USA

Phone: (800) 228-4373
(402) 464-0231
FAX: (402) 465-3085

E-mail:
IscoService@teledyne.com

The internal components of the 2151P System are not user-serviceable. The case is completely sealed to protect the internal components. If you think your module requires repair, contact Teledyne Isco's Technical Service Department.

The pressure transducer, the ultrasonic transducers, cable connections, and the electronic components of the AV Sensor are encapsulated in plastic resin and are not user-serviceable. If any part of the AV Sensor fails, it must be replaced.

Corresponding with a Teledyne Isco Service Representative can often resolve the problem without having to return the unit. If the difficulty cannot be resolved you will be issued a Return Authorization Number (RAN) and shipping information.

5.6.1 Diagnostics

As a troubleshooting aid, many module functions can generate a diagnostic file. With the assistance of a Teledyne Isco Technical Service Representative, diagnostic files can be used to isolate a problem.

To view a diagnostic file, connect to the site with Flowlink. View the measurement tab of the suspect function and click on the *Diagnostics...* button. The module then generates the file and sends it to Flowlink where it is displayed as a text report.

Flowlink can also collect all of the diagnostic files while retrieving data; the last available diagnostic files are kept in Flowlink's database where they can be viewed "off-line" at a later time. To enable Flowlink to automatically collect all diagnostic files while retrieving data, select *Utilities>Options* from the menu and check the *Retrieve data gets text reports* box on the 2100 tab.

2151P Area Velocity Flow System

Appendix A Replacement Parts

A.1 Replacement Parts Diagrams and Listings

Replacement parts are called out in this appendix for 2151P System. Reference the tables adjacent to the drawings to determine the part number and description for a particular item.

Replacement parts can be purchased by contacting Teledyne Isco's Customer Service Department.

Teledyne Isco, Inc.
Customer Service Department
P.O. Box 82531
Lincoln, NE 68501 USA

Phone: (800) 228-4373
(402) 464-0231
FAX: (402) 465-3022

E-mail: IscoInfo@teledyne.com



WARNING

Substitution of components may impair intrinsic safety.

2151P Area Velocity Flow System
Appendix A Replacement Parts

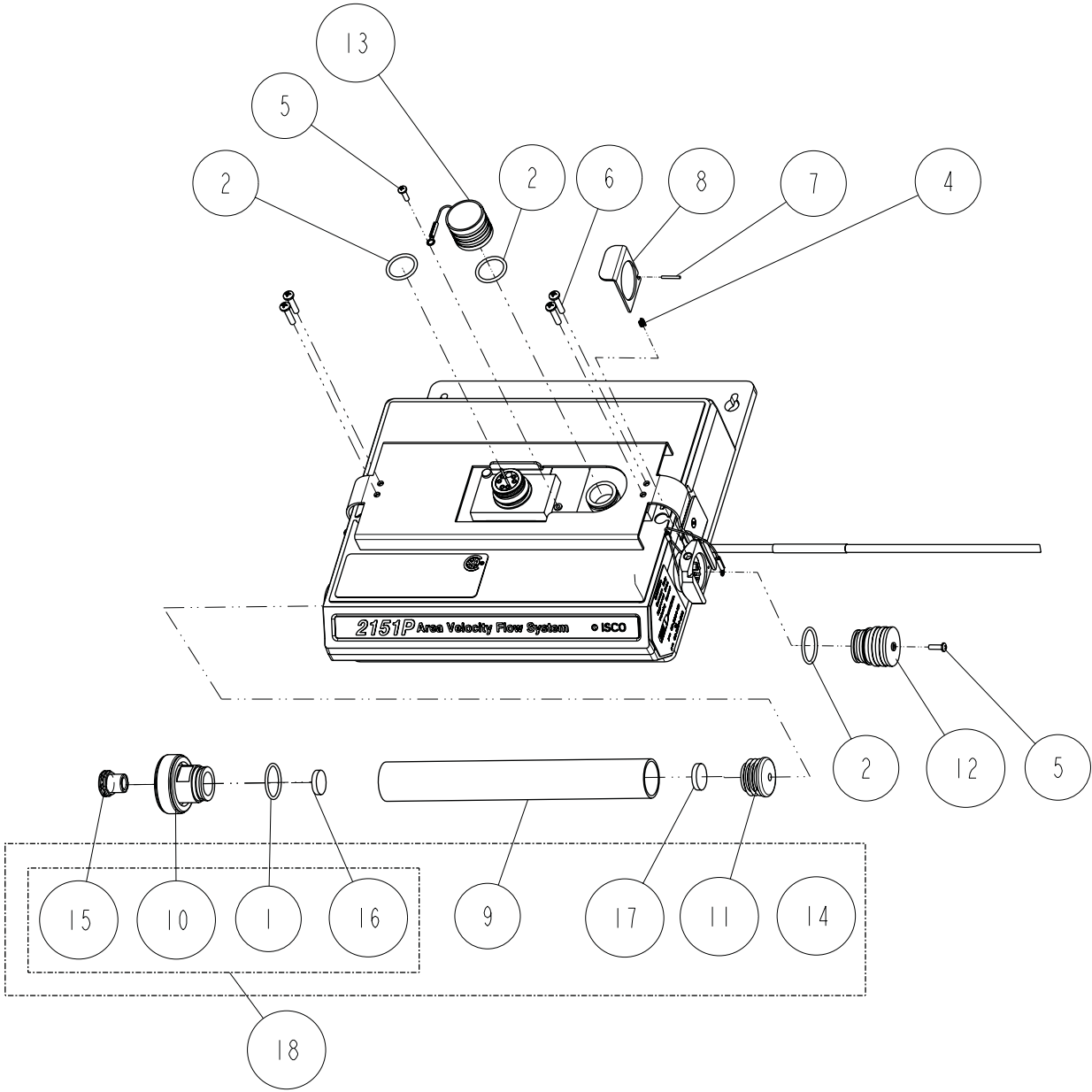

TELEDYNE ISCO, INC.
2151P AREA VELOCITY
FLOW SYSTEM

DRAWING NO.
602002227 G

SHEET 1 OF 2

REPLACEMENT PARTS LIST		
TELEDYNE ISCO, INC.		
		602002227
		SHEET: 2 OF 2
		REV: G DATE: 022008
ITEM NO.	PART NUMBER	DESCRIPTION
1	202500017	O RING, .676 ID, .070 XSECT, BUNA-N RUBBER
2	202100669	O RING, .669 ID, .079 XSECT, SILICONE
4	203011105	SPRING, .026 DIA. WIRE, .31 FREE LG
5	231310140	SCREW, SELF TAP, #4 X 3/8 "B" THD, SST
6	231514920	SCREW, SELF TAP, 6-19 X 5/8, SST
7	236410408	PIN, SPRING, 1/16 X 1/2 LG, SST
8	602003018	CONNECTOR CLIP
9	602003046	DESICCANT TUBE
10	602004265	DESICCANT CAP ASSEMBLY
11	602003074	CAP PLUG MODIFICATION, DESICCANT
12	602003076	PLUG, FEMALE PROBE
13	602004012	CAP ASSEMBLY, MALE CONNECTOR
14	602004016	DESICCANT ASSEMBLY
15	209009393	SCREW IN FILTER
16	692203300	FRIT, .620 DIA.
17	692203301	FRIT, .670 DIA.
18	602004270	GORE DESICCANT CAP
NOTE: 1. For current prices and quotations on parts, contact Isco Service Department. 2. This list is subject to change without notice.		

2151P Area Velocity Flow System

Appendix B Accessories

B.1 How to Order

Accessories can be purchased by contacting Teledyne Isco's Customer Service Department.

Teledyne Isco, Inc.
Customer Service Dept.
P.O. Box 82531
Lincoln, NE 68501 USA

Phone: (800) 228-4373
(402) 464-0231
FAX: (402) 465-3022

E-mail: IscoInfo@teledyne.com

Web Site: www.isco.com

B.2 General Accessories

RS232 Communication/Barrier Cable	60-2004-153
Network Communication/Barrier Cable.	60-2004-201
Network Isolator (for DIN rail mounting)	60-2004-224
Entity Rated Power Barrier (R. Stahl power isolator) . .	34-1001-201
DIN Rail Mount DC Power Supply	34-1000-218
Quick Disconnect Box	60-2004-228
Six Conductor Cable for use with QD Box	60-5314-417
Dummy Barrier	10-9022-008
Area Velocity Sensor, with 25 ft (7.6 m) cable	60-2004-151
Area Velocity Sensor, with 75 ft (23 m) cable.	60-2004-209
Reference Port Tubing.	60-2003-104
Hydrophobic Filter.	209-0093-93
Carrying Handle	60-1704-017
Flowlink for Windows software.	CALL
2151P Instruction Manual	60-2004-230
2151P Maintenance Kit.	60-2009-005
Isco Open Channel Flow Measurement Handbook . .	60-3003-041

B.3 AV Sensor Mounting Accessories

The 2151P Area Velocity Sensor can be installed using Isco's installation systems listed below. A Low Profile Carrier is optional when attaching the AV Sensor to any system listed below.

Low Profile Carrier

(attaches the 2151P AV sensor to a ring or plate) 60-3204-029

Ground Lag Kit 60-2007-476

Spring Rings *(Each ring includes plastic ties to fasten the cable and a manual)*

6" Dia 68-3200-007

8" Dia 68-3200-008

10" Dia 68-3200-009

12" Dia 68-3200-010

15" Dia 68-3200-011

Scissors Rings *(Each scissors ring includes a base section, scissors mechanism, extensions, plastic ties, and a manual)*

16-24" Pipe 68-3000-042

26-38" Pipe 68-3000-043

38-44" Pipe 68-3000-044

44-48" Pipe 68-3000-045

60" Pipe 68-3000-046

72" Pipe 68-3000-047

16-60" Pipe 68-3000-048

Base Section *(with plastic ties and manual)* 60-3004-169

Street Level Installation System

Multi-section Pole *(Includes manual. To complete your system, you must also order a Street Level Mounting Ring)* 60-3204-012

Street Level Mounting Ring for 6" dia. pipe 60-3204-014

Street Level Mounting Ring for 8" dia. pipe 60-3204-015

Street Level Mounting Ring for 10" dia. pipe 60-3204-016

Street Level Mounting Ring for 12" dia. pipe 60-3204-017

Street Level Mounting Ring for 15" dia. pipe 60-3204-018

Sensor Mounting Plate *(With plastic ties & instructions)* 68-3000-051

2151P Area Velocity Flow System

Appendix C Material Safety Data Sheets

C.1 Overview

This appendix provides Material Safety Data Sheets for the desiccant used by the 2151P Area Velocity Flow System.

Teledyne Isco cannot guarantee the accuracy of the data. Specific questions regarding the use and handling of the products should be directed to the manufacturer listed on the MSDS.

Material Safety Data Sheet

Indicating Silica Gel

Identity (Trade Name as Used on Label)

Manufacturer : MULTISORB TECHNOLOGIES, INC. (formerly Multiform Desiccants, Inc.)	MSDS Number* : M75
Address: 325 Harlem Road Buffalo, NY 14224	CAS Number* :
Phone Number (For Information): 716/824-8900	Date Prepared: July 6, 2000
Emergency Phone Number: 716/824-8900	Prepared By* : G.E. McKedy

Section 1 - Material Identification and Information

Components - Chemical Name & Common Names (Hazardous Components 1% or greater; Carcinogens 0.1% or greater)	%*	OSHA PEL	ACGIH TLV	OTHER LIMITS RECOMMENDED
Silica Gel SiO ₂	98.0	6mg/m ³ (total dust)	10mg/m ³ (total dust)	
Cobalt Chloride	>2.0	0.05mg/m ³ (TWA cobalt metal dust & fume)	.05mg/m ³ (Cobalt, TWA)	
Non-Hazardous Ingredients				
TOTAL	100			

Section 2 - Physical/Chemical Characteristics

Boiling Point	N/A	Specific Gravity (H ₂ O = 1)	2.1
Vapor Pressure (mm Hg and Temperature)	N/A	Melting Point	N/A
Vapor Density (Air =1)	N/A	Evaporation Rate (_____ =1)	N/A
Solubility in Water	Insoluble, but will adsorb moisture.	Water Reactive	Not reactive, but will adsorb moisture.
Appearance and Odor	Purple crystals, no odor.		

Section 3 - Fire and Explosion Hazard Data

Flash Point and Methods Used	N/A	Auto-Ignition Temperature	N/A	Flammability Limits in Air % by Volume	N/A	LEL	UEL
Extinguisher Media	Dry chemical, carbon dioxide and foam can be used.						
Special Fire Fighting Procedures	Water will generate heat due to the silica gel which will adsorb water and liberate heat.						
Unusual Fire and Explosion Hazards	When exposed to water, the silica gel can get hot enough to reach the boiling point of water. Flooding with water will reduce the temperature to safe limits.						

Section 4 - Reactivity Hazard Data

STABILITY <input type="checkbox"/> Stable <input type="checkbox"/> Unstable	Conditions To Avoid	Moisture and high humidity environments.
Incompatibility (Materials to Avoid)	Water.	
Hazardous Decomposition Products	Carbon dioxide, carbon monoxide, water	
HAZARDOUS POLYMERIZATION <input type="checkbox"/> May Occur	Conditions To Avoid	None.

*Optional

Indicating Silica Gel

Section 5 - Health Hazard Data

PRIMARY ROUTES OF ENTRY	<input type="checkbox"/> Inhalation <input type="checkbox"/> Ingestion <input type="checkbox"/> Skin Absorption <input type="checkbox"/> Not Hazardous	CARCINOGEN LISTED IN	<input type="checkbox"/> NTP <input type="checkbox"/> OSHA <input type="checkbox"/> IARC Monograph <input type="checkbox"/> Not Listed
HEALTH HAZARDS	Acute May cause eye, skin and mucous membrane irritation. Chronic Prolonged inhalation may cause lung damage.		
Signs and Symptoms of Exposure	Drying and irritation.		
Medical Conditions Generally Aggravated by Exposure	Asthma.		
EMERGENCY FIRST AID PROCEDURES - Seek medical assistance for further treatment, observation and support if necessary.			
Eye Contact	Flush with water for at least 15 minutes.		
Skin Contact	Wash affected area with soap and water.		
Inhalation	Remove affected person to fresh air.		
Ingestion	Drink at least 2 glasses of water.		

Section 6 - Control and Protective Measures

Respiratory Protection (Specify Type)	Use NIOSH approved dust mask or respirator.		
Protective Gloves	Light cotton gloves.	Eye Protection	Safety glasses.
VENTILATION TO BE USED	<input type="checkbox"/> Local Exhaust <input type="checkbox"/> Other (Specify)	<input type="checkbox"/> Mechanical (General)	<input type="checkbox"/> Special
Other Protective Clothing and Equipment	None.		
Hygienic Work Practices	Avoid raising dust. Avoid contact with skin, eyes and clothing.		

Section 7 - Precautions for Safe Handling and Use/Leak Procedures

Steps to be Taken if Material Is Spilled Or Released	Sweep or vacuum up and place the spilled material in a waste disposal container. Avoid raising dust.
Waste Disposal Methods	Dispose in an approved landfill according to federal, state and local regulations.
Precautions to be Taken In Handling and Storage	Cover promptly to avoid blowing dust. Wash after handling.
Other Precautions and/or Special Hazards	Keep in sealed containers away from moisture. The silica gel will readily adsorb moisture.

*Optional

Indicating Silica Gel



MATERIAL SAFETY DATA SHEET

Effective Date March 8, 2005
MSDS Number M163

Section 1 – Product and Company Information

Product Name: Silica gel, indicating, yellow

Product Use: Desiccant, absorbent
Grades: Silica gel, indicating
Synonyms: Amorphous silica gel, SiO₂, silicon dioxide (amorphous)

Company: Multisorb Technologies, Inc.
Street Address: 325 Harlem Road
City, State, Zip, Country: Buffalo, NY 14224-1893 USA

Telephone Number: (716) 824 8900 [USA] Monday - Friday (8:00 - 5:00 EDT)
Fax Number: (716) 824 4091 [USA]
Website / E-Mail : multisorb.com

Section 2 – Composition / Information on Ingredients

Component Name	CAS Number	% by Weight
Synthetic amorphous silica gel (SiO ₂)	112926-00-8	100
Phenolphthalein	77-09-08	100 ppm

While this material is not classified, this MSDS contains valuable information critical to the safe handling and proper use of this product. This MSDS should be retained and available for employees and other users of this product.

Section 3 – Hazard Identification

Emergency Overview: A yellow bead or granular material that poses little or no immediate hazard. This material is not combustible.

Potential Health Effects:

Eyes: Dust and or product may cause eye discomfort and irritation seen as tearing and reddening.

Skin: The product dust may cause drying of the skin. Silica gel may get hot enough to burn skin when it adsorbs moisture rapidly. Use an excess of water to cool the silica gel.

Ingestion: Material is not toxic and will pass through the body normally.

Inhalation: Slight irritation is possible but none is expected.

Medical Effects Generally Aggravated by Exposure: Respiratory ailments.

Chronic Effects/Carcinogenicity: May cause eye, skin and mucous membrane irritation and drying.

Section 4 – First Aid Measures

- Eyes:** Rinse the eyes well with water while lifting the eye lids. If irritation persists, consult a physician.
- Skin:** Wash affected area with soap and water.
- Ingestion:** Ingestion is unlikely, this material will pass through the body normally.
- Inhalation:** Remove the affected person to fresh air and get medical attention if necessary.
- Notes to Physician:** Not applicable

Section 5 – Fire Fighting Measures

- Flammable Properties:** Not flammable
- Flash Point:** Not applicable **Method:** Not applicable
- Flammable Limits:** Not flammable
- Lower Flammability Limit:** Not applicable
- Upper Flammability Limit:** Not applicable
- Autoignition Temperature:** Not applicable
- Hazardous Combustion Products:** Not applicable
- Extinguishing Media:** Use extinguishing media that is appropriate for the surrounding fire. Silica gel is not combustible.
- Fire Fighting Instructions:** Not combustible
- Unusual Fire and Explosion Hazards:** None

Section 6 – Accidental Release Measures

- Spill:** Sweep or vacuum up and place the spilled material in a waste disposal container. Avoid raising dust. Wash with soap and water after handling.

Section 7 – Handling and Storage

- Handling:** Avoid raising dust and minimize the contact between worker and the material. Practice good hygienic work practices.
- Storage:** Store in a cool, dry location. Keep in sealed containers away from moisture. The silica gel will readily adsorb moisture.

Section 8 – Exposure Controls/Personal Protection

- Engineering Controls:** Use exhaust ventilation to keep the airborne concentrations below the exposure limits.
- Respiratory Protection:** Use NIOSH approved respirator when the air quality levels exceed the TLV's.
- Skin Protection:** Light gloves will protect against abrasion and drying of the skin.
- Eye Protection:** Safety glasses.

Component Name	Exposure Limits		
	OSHA PEL	ACGIH TLV	Other Recommended Limits
Silica gel	TWA 20 mppcf (80 mg / m ³ % SiO ₂)	TWA 10 mg / m ³	NIOSH REL TWA 6 mg / m ³ IDLH 3000 mg / m ³
Phenolphthalein	Not Applicable	Not Applicable	Not Applicable

Section 9 – Physical and Chemical Properties

- Appearance:** Yellow beads or granules **Vapor Density:** Not applicable
- Odor:** None **Boiling Point:** 4046° F (2230° C)
- Physical State:** Solid bead **Melting Point:** 3110° F (1710° C)
- PH:** Not applicable **Solubility:** Insoluble in water
- Vapor Pressure:** Not applicable **Specific Gravity:** 2.1

Section 10 – Stability and Reactivity

- Stability:** Stable
- Conditions to avoid:** Moisture and high humidity environments.
- Incompatibility:** Water, fluorine, oxygen difluoride, chlorine trifluoride
- Hazardous Decomposition Products:** None
- Hazardous Polymerization:** Will not occur

Section 11 – Toxicological Information

This product and its components are not listed on the NTP or OSHA Carcinogen lists.

Animal Toxicology Tests for DOT Hazard classification
(Tests Conducted on finely ground silica gel)
1 - hour LC₅₀ (rat) > 2 mg / l
48 - hour oral LD₅₀ (rat) est. > 31,600 mg / kg
48 - hour dermal LD₅₀ (rabbit) est. > 2,000 mg / kg
Considered an ocular irritant

Human Toxicology Silica gel is a synthetic amorphous silica not to be confused with crystalline silica. Epidemiological studies indicate low potential for adverse health effects. In the activated form, silica gel acts as a desiccant and can cause a drying irritation of the mucous membranes and skin in cases of severe exposure. Multisorb Technologies Inc. knows of no medical conditions that are abnormally aggravated by exposure to silica gel. The primary route of entry is inhalation of dust.

Section 12 – Ecological Information

Not known to have any adverse effect on the aquatic environment. Silica gel is insoluble and non-toxic.

Section 13 – Disposal Information

Disposal Information If this product as supplied becomes a waste, it does not meet the criteria of a hazardous waste as defined under the Resource Conservation and Recovery Act (RCRA) 40 CFR 261. Materials of a hazardous nature that contact the product during normal use may be retained on the product. The user of the product must identify the hazards associated with the retained material in order to assess the waste disposal options. Dispose according to federal, state and local regulations.

Section 14 – Transportation Information

U.S. Department of Transportation Shipping Name: Not classified as a hazardous material. Not regulated.

Section 15 – Regulatory Information (Not meant to be all inclusive - selected regulations represented)

TSCA Listed: Yes

DSL/NDSL (Canadian) Listed: Yes

OSHA: TWA 20 mppcf (80 mg / m³ % SiO₂) for Silica gel

NIOSH: REL TWA 6 mg / m³ IDLH 3,000 mg / m³ for silica gel
Animal tests conducted in 1976 - 1978. 18 month exposure at 15 mg / m³ showed silica deposition in respiratory macrophages and lymph nodes, minimum lung impairment, no silicosis.

ACGIH: TLV - 10 mg / m³ for Silica gel

DOT: Not classified as a hazardous material.

Section 16 – Other Information

HMIS – Hazardous Materials Identification System

HMIS Rating	
Health	0
Flammability	0
Reactivity	0

0 - minimal hazard, 1 - slight hazard, 2 - moderate hazard, 3 - serious hazard, 4 - severe hazard

This MSDS was prepared by: George E. Mckedy
Senior Applications Development Specialist
Multisorb Technologies, Inc.

This data and recommendations presented in this data sheet concerning the use of our product and the materials contained therein are believed to be correct but does not purport to be all inclusive and shall be used only as a guide. However, the customer should determine the suitability of such materials for his purpose before adopting them on a commercial scale. Since the use of our products is beyond our control, no guarantee, expressed or implied, is made and no responsibility assumed for the use of this material or the results to be obtained therefrom. Information on this form is furnished for the purpose of compliance with Government Health and Safety Regulations and shall not be used for any other purposes. Moreover, the recommendations contained in this data sheet are not to be construed as a license to operate under, or a recommendation to infringe, any existing patents, nor should they be confused with state, municipal or insurance requirements, or with national safety codes.

2151P Area Velocity Flow System

Appendix D Safety Information

D.1 Safety Considerations

The 2151P Area Velocity Flow System has been designed to be intrinsically safe, and allows installation of the module in Class I, Division 1, Groups C and D hazardous locations.

The concept of intrinsic safety is to limit the energy available to a given circuit or device to a level where electrical discharge (sparking) cannot ignite the hazardous (flammable or explosive) atmosphere. With no spark ignition possible, safe operation of the equipment in areas with hazardous atmospheres is possible.

CAUTION

The 2151P System **MUST** be installed according to the 2151P installation control drawing (Teledyne Isco P/N 60-2003-227) shown in Figures 2-1 and 2-2, and the instructions in Section 2 of this manual. You must also follow the requirements of the authority having jurisdiction for equipment installation in hazardous locations at your specific installation site.

Before any 2151P is installed, the proper safety precautions must be taken. The following discussions of safety procedures are only general guidelines that supplement the information found in Section 2 of this manual. Each situation in which you install a 2151P varies. You must take into account the individual circumstances you are in. Additional safety considerations, other than those discussed here, may be required.

In field installations of the 2151P and associated equipment, the safety of the personnel involved should be the foremost consideration. No project is so important or deadline so critical as to justify the risk of human life.

This section provides general safety procedures for working in and around manholes and sewers. Section E.2 offers general safety advice; Section E.3 deals with the special problem of poisonous gases found in sewers. For specific safety information concerning the installation of a 2151P, read Section 2 of this manual thoroughly!

D.2 General Safety Procedures

The following procedures are used by Black & Veatch, a respected consulting firm, and are published here with their permission:

“Field personnel must keep safety uppermost in their minds at all times. When working above ground, rules of common sense and safety prevail. However, when entering manholes, strict safety procedures must be observed. Failure to do so could jeopardize not only your own life, but also the lives of other crew members.

1. Hazards. There are many hazards connected with entering manholes. Some of the most common hazards are:

Adverse Atmosphere. The manhole may contain flammable or poisonous gases or the atmosphere may be deficient in oxygen. Forced ventilation may be necessary.

Deteriorated Rungs. Manhole steps may be corroded and not strong enough to support a man.

It may be difficult to inspect the rungs because of poor lighting.

Traffic. Whenever manholes are located in the traveled way, barricades and warning devices are essential to direct traffic away from an open manhole.

Falling Object. Items placed near the manhole opening may fall and injure a worker in the manhole.

Sharp Edges. Sharp edges of items in or near a manhole may cause cuts and bruises.

Lifting Injuries. Unless proper tools are used to remove manhole covers, back injuries or injuries to hands and feet may result.

2. Planning. Advance planning should include arrangements for test equipment, tools, ventilating equipment, protective clothing, traffic warning devices, ladders, safety harness, and adequate number of personnel. Hasty actions may result in serious injuries. Time spent in the manhole should be kept to a minimum.

3. Adverse Atmosphere. (Refer to the table on the following pages) Before entering a manhole, tests should be made for explosive atmosphere, presence of hydrogen sulfide, and oxygen deficiency. Since combustible or toxic vapors may be heavier than air, the tests on the atmosphere must be run at least $\frac{3}{4}$ of the way down the manhole.

Whenever adverse atmosphere is encountered, forced ventilation must be used to create safe conditions. After the ventilating equipment has been operated for a few minutes, the atmosphere in the manhole should be retested before anyone enters the manhole.

When explosive conditions are encountered, the ventilating blower should be placed upwind to prevent igniting any gas that is emerging from the opening. When a gasoline engine blower is used, it must be located so that exhaust fumes cannot enter the manhole.

If testing equipment is not available, the manhole should be assumed to contain an unsafe atmosphere and forced ventilation must be provided. It should never be assumed that a manhole is safe just because there is no odor or the manhole has been entered previously.

4. Entering Manholes. Since the top of the manhole is usually flush with the surrounding surface, there may not be anything for the person who is entering the manhole to grab on to steady himself.

Persons who are entering manholes should not be permitted to carry anything in their hands as they enter the manhole, to ensure that their hands are free to hold on or grab if they slip. A good method for entering a manhole is to sit on the surface facing the manhole steps or ladder, with the feet in the hole and the arms straddling the opening for support. As the body slides forward and downward, the feet can engage a rung, and the back can rest against the opposite side of the opening. If there is any doubt about the soundness of the manhole steps, a portable ladder should be used.

A person should never enter a manhole unless he is wearing personal safety equipment, including a safety harness and hard hat. Two persons should be stationed at the surface continuously while anyone is working inside a manhole, to lift him out if he is overcome or injured. One man cannot lift an unconscious man out of a manhole.

The persons stationed at the surface should also function as guards to keep people and vehicles away from the manhole opening. To avoid a serious injury, a person should not be lifted out of a manhole by his arm unless it is a dire emergency.

When more than one person must enter a manhole, the first person should reach the bottom and step off the ladder before the second one starts down. When two men climb at the same time, the upper one can cause the lower one to fall by slipping or stepping on his fingers.

5. Traffic Protection. In addition to traffic cones, markers, warning signs, and barricades, a vehicle or heavy piece of equipment should be placed between the working area and oncoming traffic. Flashing warning signals should be used to alert drivers and pedestrians. Orange safety vests should be worn by personnel stationed at the surface when the manhole is located in a vehicular traffic area.

6. Falling Object. All loose items should be kept away from the manhole opening. This applies to hand tools as well as stones, gravel and other objects.

7. Removing the Covers. Manhole covers should be removed with a properly designed hook. Use of a pick ax, screwdriver, or small pry bar may result in injury. A suitable tool can be made from $\frac{3}{4}$ -inch round or hex stock. Two inches of one end should be bent at a right angle and the other end should be formed into a D-handle wide enough to accommodate both hands. Even with this tool, care must be exercised to prevent the cover from being dropped on the toes. The two inch projection should be inserted into one of the holes of the cover, the handle grasped with both hands, and the cover lifted by straightening the legs, which have been slightly bent at the knees.

8. Other Precautions. Other precautions that should be taken when entering a manhole are:

- Wear a hard hat.
- Wear coveralls or removable outer garment which can readily be removed when the work is completed.
- Wear boots or nonsparking safety shoes.

- Wear rubberized or waterproof gloves.
- Wear a safety harness with a stout rope attached.
- Do not smoke.
- Avoid touching yourself above the collar until you have cleaned your hands.

9. Emergencies. Every member of the crew should be instructed on procedures to be followed in cases of an emergency. It is the duty of each crew chief to have a list of emergency phone numbers, including the nearest hospital and ambulance service, police precinct, fire station, and rescue or general emergency number.

10. Field Equipment. The following equipment will be available for use:

Blowers	Harnesses
Breathing Apparatus	Manhole Irons
Coveralls	Mirrors
Emergency Flashers	Pick Axes
First Aid Kits	Rain Slickers
Flashlights	Ropes
Gas Detectors	Safety Vests
Gas Masks	Traffic Cones
Gloves	Waders”
Hard Hats	

D.3 Lethal Atmospheres in Sewers

The following is an article written by Dr. Richard D. Pomeroy, and published in the October 1980 issue of *Deeds & Data* of the WPCF. Dr. Pomeroy is particularly well known for his studies, over a period of nearly 50 years, in the field of the control of hydrogen sulfide and other odors in sewers and treatment plants. He has personally worked in a great many functioning sewers. In the earlier years he did so, he admits, with little knowledge of the grave hazards to which he exposed himself.

“It is gratifying that the subject of hazards to people working in sewers is receiving much more attention than in past years, and good safety procedures are prescribed in various publications on this subject. It is essential that people know and use correct procedures.

It is less important to know just what the hazardous components of sewer atmospheres are, as safety precautions should in general be broadly applicable, but there should be a reasonable understanding of this subject. It is disturbing to see statements in print that do not reflect true conditions.

One of the most common errors is the assumption that people have died from a lack of oxygen. The human body is able to function very well with substantially reduced oxygen concentrations. No one worries about going to Santa Fe, New Mexico, (elev. 2100 m), where the partial pressure of oxygen is equal to 16.2 percent (a normal atmosphere is about 21 percent) oxygen. When first going there, a person may experience a little 'shortness of breath' following exercise. People in good health are not afraid to drive over the high passes in the Rocky Mountains. At Loveland Pass, oxygen pressure is 13.2 percent of a normal atmosphere. At the top of Mt. Whitney,

oxygen is equal to 12.2 percent. Many hikers go there, and to higher peaks as well. After adequate acclimation, they may climb to the top of Mt. Everest, where oxygen is equal to only 6.7 percent.

The lowest oxygen concentrations that I have observed in a sewer atmosphere was 13 percent. It was in a sealed chamber, near sea level, upstream from an inverted siphon on a metropolitan trunk. A man would be foolish to enter the chamber. Without ventilation, he might die, but not from lack of oxygen.

It seems unlikely that anyone has ever died in a sewer from suffocation, that is, lack of oxygen. Deaths have often been attributed to 'asphyxiation.' This is a word which, according to the dictionary, is used to mean death from an atmosphere that does not support life. The word has sometimes been misinterpreted as meaning suffocation, which is only one kind of asphyxiation.

In nearly all cases of death in sewers, the real killer is hydrogen sulfide. It is important that this fact be recognized. Many cities diligently test for explosive gases, which is very important, and they may measure the oxygen concentration, which usually is unimportant, but they rarely measure H_2S . Death has occurred where it is unlikely that there was any measurable reduction in the oxygen concentration. Wastewater containing 2 mg/l of dissolved sulfide, and at a pH of 7.0, can produce in a chamber with high turbulence, a concentration of 300 ppm H_2S , in the air. This is considered to be a lethal concentration. Many people have died from H_2S , not only in sewers and industries, but also from swamps and from hot springs. In one resort area, at least five persons died from H_2S poisoning before the people were ready to admit that H_2S is not a therapeutic agent. Hardly a year passes in the U.S. without a sewer fatality from H_2S as well as deaths elsewhere in the world.

The presence of H_2S in a sewer atmosphere is easily determined. A bellows-and-ampoule type of tester is very satisfactory for the purpose, even though it is only crudely quantitative. When using a tester of this type, do not bring the air to the ampoule by way of a tube, as this may change the H_2S concentration. Hang the ampoule in the air to be tested, with a suction tube to the bulb or bellows.

Lead acetate paper is very useful as a qualitative indicator. It cannot be used to estimate the amount of sulfide, but it will quickly turn black in an atmosphere containing only a tenth of a lethal concentration.

Electrodes or other similar electrical indicating devices for H_2S in the air have been marketed. Some of them are known to be unreliable, and we know of none that have proved dependable. Do not use one unless you check it at frequent intervals against air containing known H_2S concentrations. A supposed safety device that is unreliable is worse than none at all.

Remember that the nose fails, too, when it comes to sensing dangerous concentrations of H_2S .

Various other toxic gases have been mentioned in some publications. It is unlikely that any person has been asphyxiated in a sewer by any of those other gases, except possibly chlorine.

The vapor of gasoline and other hydrocarbons is sometimes present in amounts that could cause discomfort and illness, but under that condition, the explosion hazard would be far more serious. The explosimeter tests, as well as the sense of smell, would warn of the danger. Pipelines in chemical plants might contain any number of harmful vapors. They, too, are sensed by smell and explosimeter tests if they get into the public sewer. Such occurrences are rare.

The attempt to instill a sense of urgency about real hazards is diluted if a man is told to give attention to a long list of things that in fact are irrelevant.

Be very careful to avoid high H₂S concentrations, flammable atmospheres, and hazards of physical injuries. Remember that much H₂S may be released by the stirring up of sludge in the bottom of a structure. Obey your senses in respect to irritating gases, such as chlorine (unconsciousness comes suddenly from breathing too much.) Be cautious about strange odors. Do not determine percent oxygen in the air. There is a danger that the result will influence a man's thinking about the seriousness of the real hazards. Most important, use ample ventilation, and do not enter a potentially hazardous structure except in a good safety harness with two men at the top who can lift you out."

Hazardous Gases

Gas	Chemical Formula	Common Properties	Specific Gravity or Vapor Density Air = 1	Physiological Effect*	Max Safe 60 Min. Exposure ppm	Max. Safe 8 Hour Exposure ppm	Explosive Range (% by vol. in air.) Limits lower/upper	Likely Location of Highest Concentration	Most Common Sources	Simplest and Cheapest Safe Method of Testing
Ammonia	NH ₃	Irritant and poisonous. Colorless with characteristic odor.	0.60	Causes throat and eye irritation at 0.05%, coughing at 0.17%. Short exposure at 0.5% to 1% fatal.	300 to 500	85	16 25	Near top. Concentrates in closed upper spaces	Sewers, chemical feed rooms.	Detectable odor at low concentrations
Benzene	C ₆ H ₆	Irritant, colorless anesthetic	2.77	Slight symptoms after several hours exposure at 0.16% to 0.32%. 2% rapidly fatal.	3,000 to 5,000	25	1.3 7.1	At bottom.	Industrial wastes, varnish, solvents.	Combustible gas indicator
Carbon Bisulfide	CS ₂	Nearly odorless when pure, colorless, anesthetic. Poisonous.	2.64	Very poisonous, irritating, vomiting, convulsions, psychic disturbance.	—	15	1.3 44.0	At bottom	An insecticide	Combustible gas indicator
Carbon Dioxide	CO ₂	Asphyxiant, Colorless, odorless. When breathed in large quantities, may cause acid taste. Non-flammable. Not generally present in dangerous amounts unless an oxygen deficiency exists.	1.53	Cannot be endured at 10% more than a few minutes, even if subject is at rest and oxygen content is normal. Acts on respiratory nerves.	40,000 to 60,000	5,000	— —	At bottom; when heated may stratify at points above bottom.	Products of combustion, sewer gas, sludge. Also issues from carbonaceous strata.	Oxygen deficiency' indicator
Carbon Monoxide	CO	Chemical asphyxiant. Colorless, odorless, tasteless. Flammable. Poisonous.	0.97	Combines with hemoglobin of blood. Unconsciousness in 30 min. at 0.2% to 0.25%. Fatal in 4 hours at 0.1%. Headache in few hours at 0.02%.	400	50	12.5 74.0	Near top, especially if present with illuminating gas.	Manufactured gas, flue gas, products of combustion, motor exhausts. Fires of almost any kind.	CO ampoules.
Carbon Tetra-Chloride	CCl ₄	Heavy, ethereal odor.	5.3	Intestinal upset, loss of consciousness, possible renal damage, respiratory failure.	1,000 to 1,500	100	— —	At bottom.	Industrial wastes, solvent, cleaning	Detectable odor at low concentrations.
Chlorine	Cl ₂	Irritant. Yellow-green color. Choking odor detectable in very low concentrations. Non-flammable.	2.49	Irritates respiratory tract. Kills most animals in a very short time at 0.1%.	4	1	— —	At bottom.	Chlorine cylinder and feed line leaks.	Detectable odor at low concentrations.
Formaldehyde	CH ₂ O	Colorless, pungent suffocating odor.	1.07	Irritating to the nose.	—	10	7.0 73.0	Near bottom.	Incomplete combustion of organics. Common air pollutant, fungicide.	Detectable odor.
Gasoline	C ₇ H ₁₂ to C ₉ H ₂₀	Volatile solvent. Colorless. Odor noticeable at 0.03%. Flammable.	3.0 to 4.0	Anesthetic effects when inhaled. Rapidly fatal at 2.4%. Dangerous for short exposure at 1.1 to 2.2%.	4,000 to 7,000	1,000	1.3 6.0	At bottom.	Service stations, garages, storage tanks, houses.	1. Combustible gas indicator. 2. Oxygen deficiency indicator**
Hydrogen	H ₂	Simple asphyxiant., Colorless, odorless, tasteless. Flammable	0.07	Acts mechanically to deprive tissues of oxygen. Does not support life.	—	—	4.0 74.0	At top.	Manufactured gas, sludge digestion tank gas, electrolysis of water. Rarely from rock strata.	Combustible gas indicator.
Hydrogen Cyanide	HCN	Faint odor of bitter almonds. Colorless gas	0.93	Slight symptoms appear upon exposure to 0.002% to 0.004%. 0.3% rapidly fatal.	—	10	6.0 40.0	Near top.	Insecticide and rodenticide.	Detector tube

*Percentages shown represent volume of gas in air.

**For concentration over 0.3%.

Hazardous Gases (Continued)

Gas	Chemical Formula	Common Properties	Specific Gravity or Vapor Density Air = 1	Physiological Effect*	Max Safe 60 Min. Exposure ppm	Max. Safe 8 Hour Exposure ppm	Explosive Range (% by vol. in air.) Limits lower/upper	Likely Location of Highest Concentration	Most Common Sources	Simplest and Cheapest Safe Method of Testing
Hydrogen Sulfide	H ₂ S	Irritant and poisonous volatile compound. Rotten egg odor in small concentrations. Exposure for 2 to 15 min. at 0.01% impairs sense of smell. Odor not evident at high concentrations. Colorless Flammable.	1.19	Impairs sense of smell, rapidly as concentration increases. Death in few minutes at 0.2%. Exposure to 0.07 to 0.1% rapidly causes acute poisoning. Paralyzes respiratory center.	200 to 300	20	4.3 45.0	Near bottom, but may be above bottom if air is heated and highly humid.	Coal gas, petroleum, sewer gas. Fumes from blasting under some conditions. Sludge gas.	1. H ₂ S Ampoule. 2. 5% by weight lead acetate solution.
Methane	CH ₄	Simple asphyxiant. Colorless, odorless, tasteless, flammable.	0.55	Acts mechanically to deprive tissues of oxygen. Does not support life.	Probably no limit, provided oxygen percentage is sufficient for life.	—	5.0 15.0	At top, increasing to certain depth.	Natural gas, sludge gas, manufactured gas, sewer gas. Strata of sedimentary origin. In swamps or marshes.	1. Combustible gas indicator 2. Oxygen deficiency indicator.
Nitrogen	N ₂	Simple asphyxiant. Colorless, tasteless. Non-flammable. Principal constituent of air. (about 79%).	0.97	Physiologically inert.	—	—	— —	Near top, but may be found near bottom.	Sewer gas. sludge gas. Also issues from some rock strata.	Oxygen deficiency indicator.
Nitrogen Oxides	NO	Colorless	1.04	60 to 150 ppm cause irritation and coughing. Asphyxiant. 100 ppm dangerous. 200 ppm fatal.	50	10	— —	Near bottom.	Industrial wastes. Common air pollutant.	NO ₂ detector tube.
	N ₂ O	Colorless, sweet odor.	1.53							
	NO ₂	Reddish-brown. Irritating odor. Deadly poison.	1.58							
Oxygen	O ₂	Colorless, odorless, tasteless. Supports combustion.	1.11	Normal air contains 20.8% of O ₂ Man can tolerate down to 12%. Minimum safe 8 hour exposure, 14 to 16%. Below 10%, dangerous to life. Below 5 to 7% probably fatal.	—	—	— —	Variable at different levels.	Oxygen depletion from poor ventilation and absorption, or chemical consumption of oxygen.	Oxygen deficiency indicator.
Ozone	O ₃	Irritant and poisonous. Strong electrical odor. Strong oxidizer. Colorless. At 1 ppm, strong sulfur-like odor.	1.66	Max. naturally occurring level is 0.04 ppm. 0.05 ppm causes irritation of eyes and nose. 1 to 10 ppm causes headache, nausea; can cause coma. Symptoms similar to radiation damage.	0.08	0.04	— —	Near bottom.	Where ozone is used for disinfection.	Detectable odor at 0.015 ppm.
Sludge Gas	—**	Mostly a simple asphyxiant. May be practically odorless, tasteless.	Variable	Will not support life.	No data. Would vary widely with composition.		5.3 19.3	Near top of structure.	From digestion of sludge.	See components.
Sulfur Dioxide	SO ₂	Colorless, pungent odor. Suffocating, corrosive, poisonous, non-flammable.	2.26	Inflammation of the eyes. 400 to 500 ppm immediately fatal.	50 to 100	10	— —	At bottom, can combine with water to form sulfuric acid.	Industrial waste, combustion, common air pollutant.	Detectable taste and odor at low concentration.
Toluene	C ₇ H ₈ to C ₉ H ₁₀	Colorless, benzene-like odor.	3.14	At 200-500 ppm, headache, nausea, bad taste, lassitude.	200	100	1.27 7.0	At bottom.	Solvent.	Combustible gas indicator.
Turpentine	C ₁₀ H ₁₆	Colorless, Characteristic odor.	4.84	Eye irritation. Headache, dizziness, nausea, irritation of the kidneys.	—	100	— —	At bottom.	Solvent, used in paint.	1. Detectable odor at low concentrations. 2. Combustible gas indicator.
Xylene	C ₈ H ₁₀	Colorless, flammable	3.66	Narcotic in high concentrations. less toxic than benzene.	—	100	1.1 7.0	At bottom.	Solvent	Combustible gas indicator.

* Percentages shown represent volume of gas in air.

**Mostly methane and carbon dioxide with small amounts of hydrogen, nitrogen, hydrogen sulfide, and oxygen; occasionally traces of carbon monoxide.

产品中有毒有害物质或元素的名称及含量

Name and amount of Hazardous Substances or Elements in the product

部件名称 Component Name	有毒有害物质或元素 Hazardous Substances or Elements					
	铅 (Pb)	汞 (Hg)	镉 (Cd)	六价铬 (Cr(VI))	多溴联苯 (PBB)	多溴二联苯 (PBDE)
线路板 Circuit Boards	X	O	O	O	O	O

产品中有毒有害物质或元素的名称及含量：Name and amount of Hazardous Substances or Elements in the product

O: 表示该有毒有害物质在该部件所有均质材料中的含量均在ST/ 标准规定的限量要求以下。

O: Represent the concentration of the hazardous substance in this component's any homogeneous pieces is lower than the ST/ standard limitation.

X：表示该有毒有害物质至少在该部件的某一均质材料中的含量超出ST/ 标准规定的限量要求。

(企业可在此处，根据实际情况对上表中打“X”的技术原因进行进一步说明。)

X: Represent the concentration of the hazardous substance in this component's at least one homogeneous piece is higher than the ST/ standard limitation.

(Manufacturer may give technical reasons to the “X”marks)

环保使用期由经验确定。

The Environmentally Friendly Use Period (EFUP) was determined through experience.

生产日期被编码在系列号码中。前三位数字为生产年(207 代表 2007 年)。随后的一个字母代表月份：

A 为一月，B 为二月，等等。

The date of Manufacture is in code within the serial number. The first three numbers are the year of manufacture (207 is year 2007) followed by a letter for the month. "A" is January, "B" is February and so on.

产品中有毒有害物质或元素的名称及含量

Name and amount of Hazardous Substances or Elements in the product

部件名称 Component Name	有毒有害物质或元素 Hazardous Substances or Elements					
	铅 (Pb)	汞 (Hg)	镉 (Cd)	六价铬 (Cr(VI))	多溴联苯 (PBB)	多溴二联苯 (PBDE)
线路板 Circuit Boards	X	O	O	O	O	O
外部电缆 External Cables	O	O	O	O	X	O

产品中有毒有害物质或元素的名称及含量：Name and amount of Hazardous Substances or Elements in the product

O: 表示该有毒有害物质在该部件所有均质材料中的含量均在ST/ 标准规定的限量要求以下。

O: Represent the concentration of the hazardous substance in this component's any homogeneous pieces is lower than the ST/ standard limitation.

X：表示该有毒有害物质至少在该部件的某一均质材料中的含量超出ST/ 标准规定的限量要求。

(企业可在此处，根据实际情况对上表中打“X”的技术原因进行进一步说明。)

X: Represent the concentration of the hazardous substance in this component's at least one homogeneous piece is higher than the ST/ standard limitation.

(Manufacturer may give technical reasons to the “X”marks)

环保使用期由经验确定。

The Environmentally Friendly Use Period (EFUP) was determined through experience.

生产日期被编码在系列号码中。前三位数字为生产年(207 代表 2007 年)。随后的一个字母代表月份：
A 为一月，B 为二月，等等。

The date of Manufacture is in code within the serial number. The first three numbers are the year of manufacture (207 is year 2007) followed by a letter for the month. "A" is January, "B" is February and so on.

Replacement Policy

Although some repairs to the Teledyne Isco 2151, 2151P, 2150EX, and 2194EX modules can be made without opening the unit (such as problems with the battery component or firmware), there are some repairs that would require opening the unit. However, the Teledyne Isco 2151, 2151P, and 2150EX modules cannot be opened for repair without voiding their intrinsically safe certification. Therefore, Teledyne Isco offers a prorated replacement cost during the first four years of ownership of the unit.

The first year is covered by Teledyne Isco's One Year Limited Factory Service Warranty, which will repair or replace your 2151, 2151P, or 2150EX module free of charge during the first year, provided it meets the terms of the warranty.

For succeeding years of ownership, if failure is due to faulty parts or workmanship, repairs that can be made without opening the unit will be done at the prevailing technical service rate. If repair would require opening the unit, Teledyne Isco will replace the unit according to the prorated costs listed below:

- Year 2: replaced at 25% of current list price
- Year 3: replaced at 50% of current list price
- Year 4: replaced at 75% of current list price
- Year 5 and after: replaced at 100% of current list price

If you have any questions regarding replacement of your unit, please contact Teledyne Isco.

Teledyne Isco One Year Limited Factory Service Warranty *

Teledyne Isco warrants covered products against failure due to faulty parts or workmanship for a period of one year (365 days) from their shipping date, or from the date of installation by an authorized Teledyne Isco Service Engineer, as may be appropriate.

During the warranty period, repairs, replacements, and labor shall be provided at no charge. Teledyne Isco's liability is strictly limited to repair and/or replacement, at Teledyne Isco's sole discretion.

Failure of expendable items (e.g., charts, ribbon, tubing, lamps, glassware, seals, filters, fittings, and wetted parts of valves), or from normal wear, accident, misuse, corrosion, or lack of proper maintenance, is not covered. Teledyne Isco assumes no liability for any consequential damages.

This warranty does not cover loss, damage, or defects resulting from transportation between the customer's facility and the repair facility.

Teledyne Isco specifically disclaims any warranty of merchantability or fitness for a particular purpose.

This warranty applies only to products sold under the Teledyne Isco trademark and is made in lieu of any other warranty, written or expressed.

No items may be returned for warranty service without a return authorization number issued from Teledyne Isco.

The warrantor is Teledyne Isco, Inc.
4700 Superior, Lincoln, NE 68504, U.S.A.

*** This warranty applies to the USA and countries where Teledyne Isco Inc. does not have an authorized dealer. Customers in countries outside the USA, where Teledyne Isco has an authorized dealer, should contact their Teledyne Isco dealer for warranty service.**

In the event of instrument problems, always contact the Teledyne Isco Service Department, as problems can often be diagnosed and corrected without requiring an on-site visit. In the U.S.A., contact Teledyne Isco Service at the numbers listed below. International customers should contact their local Teledyne Isco agent or Teledyne Isco International Customer Service.

Return Authorization

A return authorization number must be issued prior to shipping. Following authorization, Teledyne Isco will pay for surface transportation (excluding packing/crating) both ways for 30 days from the beginning of the warranty period. After 30 days, expense for warranty shipments will be the responsibility of the customer.

Shipping Address: Teledyne Isco, Inc. - Attention Repair Service
4700 Superior Street
Lincoln NE 68504 USA

Mailing address: Teledyne Isco, Inc.
PO Box 82531
Lincoln NE 68501 USA

Phone: Repair service: (800)775-2965 (lab instruments)
(800)228-4373 (samplers & flow meters)
Sales & General Information (800)228-4373 (USA & Canada)

Fax: (402) 465-3001

Email: iscoservice@teledyne.com **Web site:** www.isco.com



