

4230 Flow Meter

Installation and Operation Guide



Part #60-3233-142 of Assembly #60-3234-051
Copyright © 1994. All rights reserved, Teledyne Isco, Inc.
Revision Y, April 16, 2007.

Foreword

This instruction manual is designed to help you gain a thorough understanding of the operation of the equipment. Teledyne Isco recommends that you read this manual completely before placing the equipment in service.

Although Teledyne Isco designs reliability into all equipment, there is always the possibility of a malfunction. This manual may help in diagnosing and repairing the malfunction.

If the problem persists, call or e-mail the Teledyne Isco Technical Service Department for assistance. Simple difficulties can often be diagnosed over the phone.

If it is necessary to return the equipment to the factory for service, please follow the shipping instructions provided by the Customer Service Department, including the use of the **Return Authorization Number** specified. **Be sure to include a note describing the malfunction.** This will aid in the prompt repair and return of the equipment.

Teledyne Isco welcomes suggestions that would improve the information presented in this manual or enhance the operation of the equipment itself.

Teledyne Isco is continually improving its products and reserves the right to change product specifications, replacement parts, schematics, and instructions without notice.

Contact Information

Customer Service

Phone: (800) 228-4373 (USA, Canada, Mexico)
(402) 464-0231 (Outside North America)
Fax: (402) 465-3022
Email: IscoCSR@teledyne.com

Technical Service

Phone: (800) 775-2965 (Analytical)
(800) 228-4373 (Samplers and Flow Meters)
Email: IscoService@teledyne.com

Return equipment to: 4700 Superior Street, Lincoln, NE 68504-1398

Other Correspondence

Mail to: P.O. Box 82531, Lincoln, NE 68501-2531
Email: IscoInfo@teledyne.com
Web site: www.isco.com

General Warnings

Before installing, operating, or maintaining this equipment, it is imperative that all hazards and preventive measures are fully understood. While specific hazards may vary according to location and application, take heed of the following general warnings:

 **WARNING**

Avoid hazardous practices! If you use this instrument in any way not specified in this manual, the protection provided by the instrument may be impaired.

 **AVERTISSEMENT**

Éviter les usages périlleux! Si vous utilisez cet instrument d'une manière autre que celles qui sont spécifiées dans ce manuel, la protection fournie de l'instrument peut être affaiblie; cela augmentera votre risque de blessure.

Hazard Severity Levels

This manual applies *Hazard Severity Levels* to the safety alerts. These three levels are described in the sample alerts below.

 **CAUTION**

Cautions identify a potential hazard, which if not avoided, may result in minor or moderate injury. This category can also warn you of unsafe practices, or conditions that may cause property damage.

 **WARNING**









Warnings identify a potentially hazardous condition, which if not avoided, could result in death or serious injury.

 **DANGER**

DANGER – limited to the most extreme situations to identify an imminent hazard, which if not avoided, will result in death or serious injury.

Hazard Symbols

The equipment and this manual use symbols used to warn of hazards. The symbols are explained below.

Hazard Symbols	
Warnings and Cautions	
	The exclamation point within the triangle is a warning sign alerting you of important instructions in the instrument's technical reference manual.
	The lightning flash and arrowhead within the triangle is a warning sign alerting you of "dangerous voltage" inside the product.
Symboles de sécurité	
	Ce symbole signale l'existence d'instructions importantes relatives au produit dans ce manuel.
	Ce symbole signale la présence d'un danger d'électocution.
Warnungen und Vorsichtshinweise	
	Das Ausrufezeichen in Dreieck ist ein Warnzeichen, das Sie darauf aufmerksam macht, daß wichtige Anleitungen zu diesem Handbuch gehören.
	Der gepfeilte Blitz im Dreieck ist ein Warnzeichen, das Sie vor "gefährlichen Spannungen" im Inneren des Produkts warnt.
Advertencias y Precauciones	
	Esta señal le advierte sobre la importancia de las instrucciones del manual que acompañan a este producto.
	Esta señal alerta sobre la presencia de alto voltaje en el interior del producto.

- ADDENDUM -

The 4230 flow meter will become inaccurate displaying the depth, flow, and total flow when exposed to electromagnetic fields in excess of 1.0V/m between 105 MgHz and 820 MgHz. It is suggested that the instrument be placed in a location where these electromagnetic fields are not present, or the source of the radiation is removed from the vicinity of the instrument if possible.

4230 Flow Meter

Table of Contents

Section 1 Introduction

1.1 Description	1-1
1.2 Compatible Equipment	1-1
1.3 Operating Principles	1-2
1.3.1 Operation of the Bubbler System	1-3
1.3.2 Pressure Transducer Operation	1-3
1.3.3 Automatic Drift Compensation Valve	1-3
1.4 Software Upgrades	1-4
1.5 Controls, Indicators, and Connectors	1-4
1.6 Technical Specifications	1-4
1.7 How to Make Battery Calculations	1-10
1.7.1 Calculating Current Draw	1-11

Section 2 Programming

2.1 Getting Started	2-1
2.2 Operation of the Display	2-1
2.3 Keypad Functions	2-2
2.4 Programming Procedure	2-3
2.5 Description of Program Steps	2-5
2.5.1 Operating Mode	2-5
2.5.2 Flow Conversion Type	2-6
2.5.3 Adjust Level, Parameters	2-8
2.5.4 Reset Totalizer	2-9
2.5.5 Sampler Pacing	2-9
2.5.6 Sampler Enable	2-10
2.5.7 Alarm Dialout Mode	2-10
2.5.8 Printer	2-11
2.5.9 Reports/History	2-11
2.6 Interpreting the Program Screens	2-12
2.7 Step 1 - Operating Mode	2-12
2.7.1 Optional Outputs	2-16
2.7.2 Serial Output	2-19
2.8 Step 2 - Flow Conversion	2-31
2.8.1 Flow Metering Inserts	2-36
2.8.2 Enter Maximum Head	2-37
2.8.3 Programming the 4-20 mA Outputs	2-37
2.9 Step 3 - Parameter to Adjust	2-38
2.10 Step 4 - Reset Totalizer	2-45
2.11 Step 5 - Sampler Pacing	2-45
2.12 Step 6 - Sampler Enable	2-47
2.13 Step 7 - Alarm Dialout Mode	2-51
2.14 Step 8 - Printer	2-53
2.15 Step 9 - Reports/History	2-55
2.15.1 Flow Meter History Contents	2-57

Section 3 Installation

3.1	Preparation for Use	3-1
3.1.1	Install Desiccant Canister	3-1
3.1.2	Install External Desiccant Cartridge	3-1
3.1.3	Opening the Case	3-2
3.2	Connection to a Power Source	3-2
3.2.1	Low Power Indication	3-2
3.2.2	Isco Sampler	3-3
3.2.3	Isco Nickel-Cadmium Battery	3-3
3.2.4	Isco Lead-Acid Battery	3-4
3.2.5	AC Power Supplies	3-4
3.2.6	External 12 Volt Direct Current Source	3-5
3.3	Bubble Rate	3-5
3.3.1	Setting the Bubble Rate	3-6
3.3.2	Bubble Rate and Power Consumption	3-6
3.3.3	Purging a Clogged Bubble Line	3-7
3.3.4	Adjusting the Bubble Rate	3-7
3.3.5	Locking the Bubble Rate	3-8
3.3.6	Effects of Changing the Bubble Rate	3-8
3.3.7	Super Bubble	3-8
3.4	4230 Mounting and Installation.	3-9
3.4.1	Carrying Handle	3-9
3.4.2	Location of the Flow Meter	3-9
3.4.3	Safety Considerations	3-9
3.5	The Bubble Line	3-10
3.5.1	Standard Bubble Lines	3-10
3.5.2	Comparing Vinyl and Teflon Bubble Lines	3-10
3.5.3	Bubble Line Length	3-11
3.5.4	Teflon Line Connector	3-11
3.5.5	Attaching the Teflon Bubble Line	3-11
3.5.6	Attaching the Vinyl Bubble Line	3-12
3.5.7	Installing the Bubble Line	3-12
3.5.8	High-Velocity Flow Streams	3-14
3.5.9	Stilling Wells	3-15
3.5.10	Flume Bubble Line Fittings	3-15
3.5.11	Bubble Line Extensions	3-15
3.5.12	Open Channel Installation	3-16
3.6	Flow Metering Inserts.	3-16
3.7	The Bubbler Tube Retainer Assembly	3-18
3.8	Connection to a Sampler.	3-18
3.8.1	Connection to Other Isco Equipment	3-19

Section 4 Optional Equipment

4.1	4200T Modem	4-1
4.1.1	How it Works	4-1
4.1.2	Modem and Flowlink Software	4-2
4.1.3	Connection to a Line	4-2
4.1.4	Types of Service	4-3
4.2	Connections to External Serial Device.	4-4
4.3	4 to 20 mA (Analog) Outputs	4-5
4.3.1	External 4-20 mA Output Interface	4-5
4.3.2	Internal Analog Output Board	4-6
4.4	Tipping Bucket Rain Gauge	4-8
4.5	Isco Flowlink Software	4-9
4.6	High-Low Alarm Relay Box	4-9
4.6.1	Installation	4-10

4.6.2	Wiring to a 4200 Series Flow Meter	4-10
4.7	Parameter Sensing	4-11
4.7.1	Installation of Parameter Probes	4-11
4.7.2	Temperature Probe	4-12
4.8	pH Probe	4-12
4.8.1	How the pH Probe Works	4-13
4.8.2	pH Probe Calibration	4-14
4.8.3	pH Probe Installation Guidelines	4-15
4.8.4	Storage and Maintenance of pH Probes	4-18
4.9	The Dissolved Oxygen (D.O.) Probe	4-19
4.9.1	How the D.O. Probe Works	4-20
4.9.2	Probe Preparation	4-21
4.9.3	Membrane Thicknesses	4-22
4.9.4	Probe Installation	4-22
4.9.5	Probe Operation and Precautions	4-22
4.9.6	Calibrating the D.O. Probe with a Flow Meter	4-24
4.10	Installation of Parameter Probes in Round Pipes	4-26
4.10.1	Spring Rings	4-26
4.10.2	Scissors Rings	4-27
4.11	YSI 600 Multiple Parameter Sonde	4-28
4.12	Mechanical Totalizer	4-31

Section 5 Maintenance and Service

5.1	Care of the Flow Meter Case	5-1
5.1.1	Care of the Case Seal	5-1
5.1.2	Preventing Moisture Damage	5-1
5.2	Desiccators	5-2
5.2.1	Regenerating the Internal Case Desiccant	5-2
5.2.2	Regenerating the External Desiccant Cartridge	5-3
5.3	Bubble Line Maintenance	5-4
5.3.1	Inspection of the Bubble Line Outlet	5-4
5.3.2	Automatic Air Purge	5-5
5.4	Maintenance of the Printer	5-5
5.4.1	Changing the Paper Roll	5-5
5.4.2	Ink Ribbon Replacement	5-7
5.4.3	Do Not Lubricate or Disassemble	5-8
5.5	Servicing And Troubleshooting	5-8
5.5.1	Disassembling the Flow Meter	5-8
5.5.2	Fuse Replacement	5-9
5.5.3	Display Warnings	5-10
5.6	System Reset	5-10
5.7	Operation of the Bubbler System	5-11
5.7.1	Internal Air Pump	5-11
5.7.2	Air Output to Bubble Line	5-12
5.7.3	Purge	5-12
5.7.4	Pressure Transducer	5-13
5.7.5	Automatic Drift Compensation Valve	5-13
5.8	Preliminary Troubleshooting Steps	5-14
5.8.1	If Serious Problems Occur	5-14
5.8.2	Processor	5-14
5.9	Precautions for Servicing CMOS Circuitry	5-15
5.9.1	Hazard of Static Electricity	5-15
5.10	Using FLASH UPDATE	5-17
5.10.1	Getting Started	5-17
5.10.2	Before Running FLASH UPDATE	5-17
5.10.3	Running FLASH UPDATE	5-18
5.10.4	About Preferences	5-18

Appendix A Accessories and Replacement Parts

A.1 Replacement Parts	A-1
A.2 Accessories	A-8

Appendix B Programming Worksheets

B.1 Setup	B-1
B.2 Flow Conversion: Level-to-Flow Rate	B-3
B.3 Parameter to Adjust	B-5
B.4 Reset Totalizer	B-5
B.5 Sampler Pacing	B-5
B.6 Sampler Enable	B-5
B.7 Alarm Dialout Mode	B-6
B.8 Printer	B-6
B.9 Reports/History	B-7

Appendix C General Safety Procedures

C.1 Practical Safety Precautions	C-1
C.2 Lethal Atmospheres in Sewers	C-4
C.3 Hazardous Gases	C-6

Appendix D Material Safety Data Sheets

D.1 Overview	D-1
------------------------	-----

List of Figures

1-1 4230 Controls and Indicators	1-5
1-2 4230 Side View Showing Connectors and Pin Functions	1-6
1-3 Measuring Flow Meter Current	1-12
2-1 The YSI 600 Sonde	2-9
2-2 Flow Metering Insert	2-37
2-3 Level Measurement in Round Pipes	2-39
2-4 YSI 600 Sonde Calibration Flow Chart	2-44
3-1 Battery Installed on Flow Meter	3-4
3-2 4230 Suspended by Handle (handles may vary)	3-10
3-3 Attaching the Bubble Line to the 4230	3-13
3-4 Positioning the Bubble Line in the Flow Stream	3-14
3-5 Installing the Stainless Steel Bubble Line Extension	3-16
3-6 Flow Metering Insert	3-17
3-7 Bubbler Tube Retainer Assembly	3-18
4-1 4-20 mA Output Interface	4-6
4-2 674 Tipping Bucket Rain Gauge	4-9
4-3 Temperature Probe	4-12
4-4 pH Probe With Protective Cap	4-13
4-5 201 pH Module	4-17
4-6 D.O. (Dissolved Oxygen) Probe	4-20
4-7 D.O. Parameter Module	4-24
4-8 Sensor Installed on a Spring Ring	4-26
4-9 Scissors Ring Adjustment	4-28
4-10 YSI 600 Multiple Sensor Sonde	4-29
5-1 Location of the Case Desiccating Canister	5-2
5-2 Changing the Chart Paper	5-5
5-3 Ink Ribbon Replacement	5-7
5-4 Lifting the Flow Meter from the Case	5-9

5-5	Location of the Three Fuses	5-10
5-6	4230 Bubbler System Pressure Control	5-12
5-7	Schematic Diagram of the Bubbler System	5-13
5-8	Update File Menu	5-19
5-9	Options Menu	5-19
5-10	Preferences Window	5-19

List of Tables

1-1	4230 Controls, Indicators, and Connectors	1-7
1-2	4230 Technical Specifications	1-7
1-3	Technical Specifications for Flowlink and Bubbler	1-8
1-4	4230 Chart Longevity	1-9
1-5	Battery Life Expectancy	1-9
2-1	ASCII Output Codes	2-20
4-1	4-20 mA Output Interface: Technical Specifications	4-5
4-2	Multiple Analog Output Board: Technical Specifications (each circuit)	4-7
4-3	pH Probe Technical Specifications	4-18
4-4	D.O. Probe Technical Specifications	4-23
4-5	YSI 600 Technical Specifications	4-29
5-1	Minimum DOS and Computer Hardware Requirements	5-20
C-1	Hazardous Gases	C-6

4230 Flow Meter

Section 1 Introduction

This section provides a general introduction to the 4230 Bubbler Flow Meter. It includes a description of the flow meter, an explanation of how the unit operates, and technical specifications.

Manual Organization – This manual provides the information necessary to operate, maintain, and perform minor service on the 4230. The manual is organized into five sections:

Section 1: Introduction, operation, and specifications

Section 2: Keypad operation and programming for the 4230 Flow Meter

Section 3: Installation and options application-specific to the 4230

Section 4: Options and accessories for all 4200 Series flow meters

Section 5: Routine maintenance and minor service

Following Section 5 are appendices covering safety, accessory parts, replacement parts, and material safety data.

1.1 Description

The 4230 uses the bubbler method of level measurement. The flow meter is normally used with some type of primary measuring device to measure flow in an open channel. The 4230 has built-in standard level-to-flow conversions, that cover the vast majority of open channel flow measurement situations. The 4230 is also capable of calculating flow using the Manning Equation. Additionally, you can enter a non-standard equation or data points, that effectively plot a user-derived flow profile for a flow stream. The 4230 supports the Isco data acquisition, storage, and retrieval system with the use of optional Flowlink software. The 4230 has enough memory to store over 40,000 data readings. An optional 4200T Modem, with speech capability, is available to transmit stored data over standard dial-up telephone lines.

1.2 Compatible Equipment

The 4230 Flow Meter may be used with the following equipment:

Manufactured by Teledyne Isco

- 6700 Series Portable and Refrigerated Samplers
- 3700 Series Sequential, Composite and Refrigerated Samplers
- GLS and Glacier Compact Samplers
- 4-20 mA Output Interface
- Tipping Bucket Rain Gauge
- High-Low Alarm Relay Box

Manufactured by Others

- IBM Personal Computer or compatible clone with Isco Flowlink software
- Laptop Computer with Isco software
- YSI 600 Multi-Parameter Sonde

Optional Equipment and Accessories

- 4200T Modem - Speech-capable, with connector and cable
- D.O. (dissolved oxygen) and pH parameter probes
- Flow Metering Inserts for round-pipe installations in sizes of 6", 8", 10", and 12".
- Bubble lines, in lengths of 25 feet (Teflon 0.125" OD, 0.065" ID) and 50 feet (vinyl 0.250" OD, 0.125" ID)
- Stainless steel extension tube for the bubble line (4.0 feet 0.125" OD)
- Isco Flowlink® Software for data acquisition, storage, and management
- Carrier and Mounting rings for mounting the bubble line outlet in round pipes.

1.3 Operating Principles

When measuring flow rate, the 4230 is used with a primary measuring device (typically a weir or a flume) or other open channel flow arrangement where a known relationship exists between level and flow rate. The level measuring device is a bubbler which measures the liquid level in the flow stream. The flow meter electronically converts the level reading into a properly-scaled flow rate value. The flow meter also provides standard or optional flow-related output signals to be used for:

- Flow-proportional sampler pacing and enabling
- Recording flow rate information on an external printer/plotter or circular chart recorder
- Data transfer through a modem
- Control of a 4-20 mA device
- Data transfer by a laptop computer

The flow meter contains microprocessor-controlled circuitry to calculate level and flow rate from the signals produced by the pressure transducer, store the program you entered, and operate the display and the internal printer. An alphanumeric liquid crystal display (LCD) is provided to show current total flow, level, and flow rate, and to prompt you in programming the flow meter during setup or subsequent program changes. An internal printer provides a "hard copy" printout of the information computed by the flow meter, plots level or flow rate, and generates reports. Connectors for other equipment used with the 4230 are arranged vertically on the right side of the flow meter case.

1.3.1 Operation of the Bubbler System

The bubbler system, used by the 4230 to sense level in the flow stream, works as follows: A small compressor pumps air into a reservoir. This air is released slowly by a needle valve into a bubble line, a length of small diameter flexible tubing. The other end of this tube is submerged in the flow stream. Inside the flow meter, the bubble line also connects to one side of a differential pressure transducer. As air is released slowly into the bubble line by the needle valve, pressure builds inside the line to force the air out of the line into the flow stream. When there is enough pressure to counteract the hydrostatic pressure of the flow stream, a bubble will be forced from the end of the line. The amount of pressure required to force the bubble from the end of the line is directly dependent on the hydrostatic pressure of the flow stream over the end of the bubble line. The pressure transducer inside the flow meter senses this pressure and converts it into an electrical signal that the 4230 converts into level. From the measured level detected by the bubbler and consulting lookup tables for the primary device you are using, the flow meter then calculates flow rate and total flow.

1.3.2 Pressure Transducer Operation

The differential pressure transducer used with the bubbler contains a resistance bridge on a silicon diaphragm. Pressure against one side of this diaphragm causes it to flex slightly. This flexing causes the resistors on one side of the bridge to stretch slightly. At the same time the resistors on the other side of the bridge compress slightly. The result is an unbalance in the bridge, proportional to the increase of air pressure, caused in turn by an increase in level of the flow stream. This bridge is fed from a constant-voltage source; changes in output are the result of changes in pressure.

1.3.3 Automatic Drift Compensation Valve

The 4230 Flow Meter contains the software and circuitry necessary to measure the output of the pressure transducer at zero pressure. When the flow meter is first turned on, and periodically after that, the processor actuates the automatic drift compensation valve, which connects the input port of the pressure transducer to the reference port. With the two ports connected, it then measures the output offset. The flow meter stores this offset reading in memory and uses it in level calculations. The flow meter periodically repeats this zero-offset measurement and stores the new reading in memory. The repetition of this process causes zero drift in the pressure transducer or the amplifier to cancel out, eliminating the most significant cause of drift, especially when the flow meter is operating at low water levels.

The valve also provides temperature compensation at zero pressure. The software controlling the 4230 determines how often this compensation cycle is repeated. Drift compensation cycles range from two to fifteen minutes.

1.4 Software Upgrades

To update the software in a 4200 Series Flow Meter, you do not have to return the unit to the factory or replace an EPROM. With Flash Memory, software updates can easily be installed in the field with a disk, a computer, and a cable. See Section 5 for instructions for Flash software updates. For more information about installing software upgrades in the 4230 Flow Meter, contact your Teledyne Isco representative or call the factory.

1.5 Controls, Indicators, and Connectors

The controls, indicators, and connectors of the 4230 Flow Meter are listed in Table 1-1, and their functions are briefly described. Refer to Figure 1-1 for a view of the controls and indicators, and Figure 1-2 for a view of the connectors and their pin functions.

1.6 Technical Specifications

The technical specifications for the 4230 Flow Meter are found in Table 1-2. The anticipated longevity for a roll of paper used in the printer is shown for various chart speeds in Table 1-4. Battery life expectancy for three programming combinations is found in Table 1-5, with a brief description of how to make battery calculations immediately following.

 Note

Various options and accessories used with the 4230 are described throughout the manual. For convenience, the Teledyne Isco part numbers for these items are listed on the Accessory Parts List found at the end of the Replacement Parts List. Part numbers for equipment not listed on this sheet are available from the factory.



Figure 1-1 4230 Controls and Indicators

Pin	Function
A	Ground
B	12V
A	12V
B	Ground
C	Flow Pulse Output
D	Bottle Number Input
E	Event Mark Input
F	Inhibit/Enable Output
A	12V
B	Ground
C	SDO
D	Rain Gauge Input
A	12V
B	Ground
C	Sense Line
D	SDO
E	SDI
F	Analog Output Pulse
B	Tip
C	Ring
A	12V
B	Ground
C	Input Signal (+)
D	Temp (-)
E	Temp (+)
F	Switched 12V
G	Input Signal (-)

Channel Assignments:
 A = Channel 1 (-) Red
 B = Channel 3 (+) Green
 C = Channel 1 (+) White
 D = Channel 2 (-) Brown
 E = Channel 3 (-) Black
 F = Channel 2 (+) Blue

Bubble Rate Adjust Knob

Figure 1-2 4230 Side View Showing Connectors and Pin Functions

Table 1-1 4230 Controls, Indicators, and Connectors		
CONTROLS	SETTINGS	FUNCTION
ON/OFF	On - Off	Turns the flow meter on and off. Internal memory is protected with a standby battery. See Section 2 .
Keypad	Momentary Switches	24-key. 4 column matrix - Program flow meter through series of key-strokes prompted by messages on the display. Certain keys perform specific functions, (printing reports or entering program choices into memory). Arrow keys move through menus. Number keys enter numeric values. See Section 2 .
Bubble Rate Adjust Valve	1 bubble per second (normally)	Controls the rate of air discharge from the pump and reservoir into the bubble line.
INDICATOR	READING	FUNCTION
Display	Multi-function	2-line, 40 characters per line, liquid crystal display (LCD.) Prompts you through program procedure; displays total flow, present flow rate and level. May also display parameter readings, if sensors present.
Internal Printer	Various	Provides hard copy of total flow, level or flow rate variation over time; provides sampling information and a printout of the program. Prints reports. Generates up to 3 different linear data plots. Chart characters and plots are generated on plain paper roll with an ink ribbon.
CONNECTOR	TYPE	FUNCTION
12 VDC	2-pin male M/S	Connects 12 VDC power to flow meter
Sampler	6-pin male M/S	Connects flow meter to sampler; provides flow pulse to sampler; receives sampler bottle number, composite sample and event mark signal.
Rain Gauge/ YSI 600 Sonde	9-pin female M/S (Custom)	Connects flow meter to a Isco Rain Gauge or YSI 600 Multi-Parameter Sonde. Also provides output to High-Low Alarm Relay Box.
Interrogator	6-pin female M/S	Provides serial data in/out and power. Can also be used with 4-20 mA Output Interface.
Modem (optional)	5-pin male M/S	Connects flow meter to telephone line for remote data transmission. This connector will only be present on units that have the optional modem installed.
Analog Output (optional)	6-pin male M/S	Provides analog data output from the flow meter to external, non-Isco control and recording devices.
Parameter	7-pin female M/S	Connects flow meter to parameter sensor: temperature, pH, or D.O. Note that you can only have temperature and one parameter (pH or D.O.) at the same time.

Table 1-2 4230 Technical Specifications	
Physical and Electrical	
Size	17" high × 11 ¹ / ₂ " wide × 10 ¹ / ₂ " deep (without power source)
Weight	19 lb. 1 oz
Material	High-impact molded polystyrene structural foam
Type	Self-certified NEMA 4X Enclosure
Display Type	2-line, 40 character/line alphanumeric dot matrix liquid crystal
Power	12 -14 VDC, 16 mA average at 12.5 VDC (Printer set at 1" per hour)

Table 1-2 4230 Technical Specifications (Continued)

Typical Battery Life	7-10 days with printer at 1" per hour and 4 Ampere-hour Ni-Cad battery 12 days with purge and printer turned <i>off</i> and bubble rate set at 1 bubble per second
Operating Temperature	0° to 140°F (-18° to 60°C)
Storage Temperature	-40° to 158°F (-40° to 70°C)
Additional Power Required for Optional Equipment	
Modem	60 mA maximum during operation; 0.1 mA maximum standby
High-Low Alarm Relay Box	10 mA standby, typical; 190 mA - both relays operated
Internal Printer	
Chart Speeds	Off, 1/2, 1, 2, or 4 inches per hour
Ribbon	19.7 ft. (6 m) black nylon - replaceable
Operating Speed	1.5 lines per second at 68°F. (20° C)
Character Size	0.09" high × 0.07" wide (2.4mm × 1.7 mm), 12 pitch
Printer Recording Span	User-selected from 3/4 ft. (3.6 cm) to over 30 ft. (9.1 m) with multiple over-ranges 1/240 of selected recording span
Chart Resolution	0.001 ft. (0.3 mm)
Display Resolution	
Paper	4.5" wide × 65 ft. (11.4 cm × 19.8 m) plain white paper, replaceable
Plotter Reliability	2.5 million lines MCBF (mean cycles before failure)
Reports Printed	Program selections, interval activity reports, flow meter history
Printer Recording Modes	Level over time, flow rate over time; includes totalized flow, sampler events, rainfall, temperature, pH (or) D.O.
Plotted Linear Data	3 different linear plots can be printed at the same time

Table 1-3 Technical Specifications for Flowlink and Bubbler

Isco Flowlink Data Storage and Retrieval System	
Memory Partitions	Maximum of 6 user-defined memory partitions for level or event storage
Data Storage	Rate of data storage user-selected in 1, 2, 5, 10, 15, 30, 60, or 120 minute intervals
Baud Rates	Serial connection - 300, 1200, 2400, 4800, or 9600 baud. Serial connection with the optional internal modem - 2400 baud
Storage	80,000 bytes, apportioned per reading as follows: flow = 4 bytes, level = 2 bytes, sample = 4 bytes, pH or D.O. = 1 byte)
Level Date	Level readings are stored as a 16-bit number representing 1/10,000 meter (0.0394 inch); effective range is 0-65279 meters
Bubbler Specifications	
Measurement Range	0.01 ft. (3 mm) to 10.0 ft. (3.1 m)
Maximum Depth	21.0 ft. (6.4 m)

Table 1-3 Technical Specifications for Flowlink and Bubbler (Continued)	
Measurement Accuracy (22°C, 1 bubble per second)	Level change of 0.01 to 1.0 ft. (0.006 to 1.5 m) ±0.005 ft. (0.003 m) Level change of 0.1 to 5.0 ft. (0.03 to 1.6 m) ±0.010 ft. (0.006 m) Level change of 0.1 to 10.0 ft. (0.03 to 3.1 m) ±0.035 ft. (0.01 m)
Long-term calibration change	Typically, 0.5% of reading per year
Temperature effects on level measurement accuracy	Maximum error (feet) = 0.0003 × Level (in feet) × Temperature (Deviation from 22°C within compensated range)
Transducer Pressure Safety Range	Transducer is capable of withstanding maximum air pump outlet pressure without damage
Standard Bubble Lines	25 ft. (7.6 m) 0.125" (0.32 mm) OD, 0.065" (0.17 cm) ID Teflon® 50 ft. (15.2 m) 0.250" (0.63 cm) OD, 0.125" (0.32 cm) ID vinyl
Automatic Drift Compensation	Zero-corrected to ±0.002 ft. (0.0006 m) at intervals of 2 to 15 minutes. (Interval is software-controlled.)
Optional	Stainless steel extension tubes for the bubble line. 4 ft. 1.2 m long × 0.065" (0.17 cm) or 0.125" (0.32 cm) ID
Compensated Temperature Range	0° to 60°C
Miscellaneous	
Flow Rate Calculations	The flow meter creates a table of level-versus-flow rate from program selections; this table divides the level span into 256 equally-spaced level increments. Each level increment corresponds to a specific flow rate. During data collection, if the measured level falls between two table values, the flow meter will perform a linear interpolation to calculate the flow rate value.

Table 1-4 4230 Chart Longevity	
Chart Speed, Inch/Hour (Note: Report Generator is OFF)	Time to Empty Roll
4	195 Hours (8 ¹ / ₈ Days)
2	16 ³ / ₄ Days
1	32 ¹ / ₂ Days
0.5	65 Days

Table 1-5 Battery Life Expectancy			
Flow Meter Settings	Minimum	Default ²	Maximum
Bubble Rate	1.5 / Second	1.5 / Second	1.5 / Second
Printer	Off	Off	4" per Hour
Report Generator	Off	Off	Every Hour
Purge Interval	1 Hour	15 Minutes	5 Minutes
Purge Duration	1/2 Second	1/2 Second	3 Seconds
Average Current	14 mA	15 mA	27 mA

Table 1-5 Battery Life Expectancy (Continued)

Nickel-Cadmium ³	10.7 Days ⁵	10 Days	5.5 Days
Lead-Acid ⁴	17.4 Days	16.2 Days	9 Days
<p>Notes</p> <ol style="list-style-type: none"> 1. These figures are approximations based on calculations; actual times for your flow meter may deviate due to factors of battery age, charge condition, operating temperatures, and component variations. "Minimum" settings are those providing the lowest average current draw. "Maximum" settings are those requiring the highest current draw. Your program should draw somewhere between the two. 2. The default settings are the program entered at the factory. You can reset the flow meter to the default program at any time by pressing the 1 and CLEAR ENTRY keys at the same time. 3. This battery has a capacity of 4.0 ampere-hours at room temperature (20° C). 4. This battery has a capacity of 6.5 ampere-hours at room temperature (20° C). (Both batteries are assumed to be fully-charged with at least 95% of rated capacity and in good condition. These calculations also assume a 5% safety factor at the end of discharge. Lead-acid batteries should never be completely discharged.) 5. All fractional times are rounded down, rather than up. 			

1.7 How to Make Battery Calculations

To calculate battery life expectancy for an installation, you must know two things:

- The capacity of the battery you are using
- The average current draw of the flow meter or (other device) powered

Battery capacity is expressed in ampere-hours. The battery manufacturer provides this information for each battery. This value is the product of a load current times an arbitrary time period, ten hours for nickel-cadmium batteries, and twenty hours for lead-acid types. The terminal voltage of the battery at the end of this time period is the discharged cell voltage, 10 volts for nickel-cadmium and 10.5 volts for lead-acid types. Batteries are considered **fully discharged** well before the terminal voltage drops to zero volts.

Isco batteries are rated at 4 ampere-hours for the nickel-cadmium and 6.5 ampere-hours for lead-acid types. Convert the battery current capacity into milliamperes and then divide this figure by the average current drawn by the unit. This will give you a number in hours. Divide that figure by 24, and you will have the number of days.

Note that the published ampere-hour figures do not mean that you can expect to draw 4 amperes from the nickel-cadmium battery (or 6.5 amperes from the lead-acid battery) for one hour. At the one-hour rate, discharges are typically less than half the ten- or twenty-hour rate.

To convert ampere-hours to milliamperes, multiply by 1,000.
Examples:

$$4 \text{ ampere-hours} \times 1,000 = 4,000 \text{ mAh}$$

$$6.5 \text{ ampere-hours} \times 1,000 = 6,500 \text{ mAh}$$

If you divide this figure by the average current of the flow meter, say 15 mA, you will have:

$$4,000 \div 15 = 266.67 \text{ hours}$$

Divide this number by twenty-four to get days:

$$266.67 \text{ hours} \div 24 = 11.1 \text{ days}$$

For considerations of safety, we suggest you subtract 10% from this number (100% – 5% for 95% capacity and 5% for a reserve at the end of discharge).

$$11.1 - 1.1 = 10 \text{ days}$$

This is the battery expectancy for a nickel-cadmium battery with a 15 mA continuous average drain, with a 10% derating factor. You can use the same method to calculate for lead-acid batteries, except the current will be 6,500 mA, and the period correspondingly longer, in this case a little over 16 days. You can run the full number of days calculated without derating if your batteries are new and at 100% capacity, but you will leave yourself no safety factor if you are in error on either of these assumptions. Remember, if the battery fails, there will be a period of time during which no measurements will be taken, (and no data stored, if you are also using Flowlink® software).

Batteries lose capacity as they age. Capacity also drops off as temperature falls. Low temperatures make less capacity available due to the slowing of the chemical reactions, while high temperatures accelerate the deterioration of battery plate separators, particularly if they are aged. Nickel-cadmium batteries show fairly rapid rates of self-discharge. A battery that is fully charged and then placed in storage will lose some capacity each day. In a week, this could easily be 5% or more.

When using lead-acid batteries, you must be careful to avoid complete discharge, as this may cause cell reversal, which will ruin the battery. Also, complete discharge in low temperature ambients may cause the battery to freeze, which can deform the plates or even crack the case. **Always operate these batteries with a reserve factor.**

1.7.1 Calculating Current Draw

Calculating current draw for a 4230 Flow Meter is somewhat more difficult than calculating the battery capacity. You cannot simply measure the idle current of the unit unless the printer and report generator are turned off in the program. These functions require power periodically, but not all the time. If the figures given in the previous table are not satisfactory for your application, you can use the following procedure (shown in Figure 1-3) to measure the actual current draw.

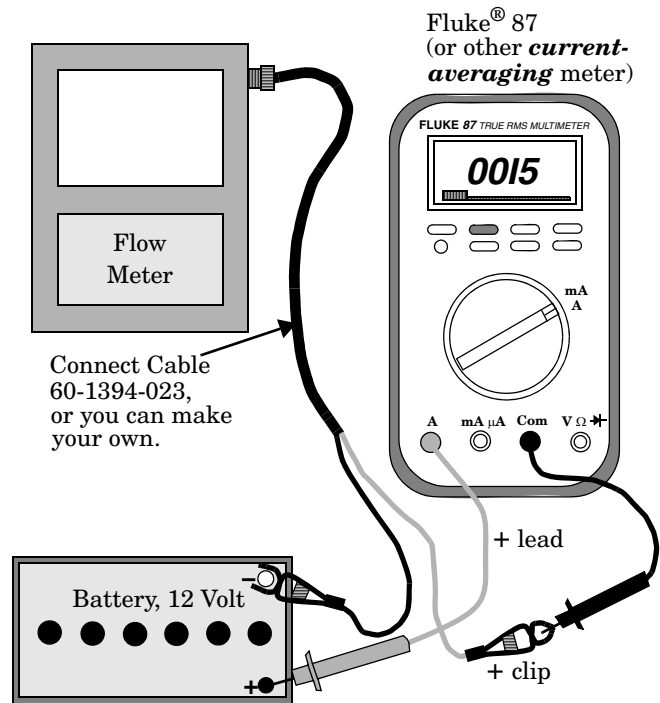

A good quality, adjustable, regulated DC power supply can be substituted for the 12-volt battery. The power supply should have at least 3 Amperes output, preferably more, and capable of overcurrent surges.

Figure 1-3 Measuring Flow Meter Current

Note

Do not attempt this procedure unless you have the proper equipment available and know how to make electrical measurements.

To measure current for a varying load requires a more-sophisticated type of multimeter, one that is capable of averaging high and low readings over a period of time. The Fluke® 87 Multimeter is one example of this type of meter. You should set the meter on MIN/MAX and let it run with your program for several hours or more. Other manufacturers' meters are also acceptable, but only if they are capable of averaging current draw. You should run the test for at least eight hours, longer if necessary, or until the flow meter has exercised the entire program. The longer you run the test, the more accurate the average will be.

More information about batteries used to power Isco equipment is available from the *Isco Power Products Guide*, which is shipped with this manual and any flow meter order.

4230 Flow Meter

Section 2 Programming

2.1 Getting Started

You must program the 4230 Flow Meter to accurately monitor a flow stream. The 4230 will usually also need a primary measuring device, a structure placed across a stream that regulates flow. This section describes programming the flow meter with the aid of the keypad and display. There are nine program steps that control all aspects of the flow meter's operation.

Teledyne Isco ships the flow meter with a program already installed that is called the **default program**. You can use this program as an example to see the flow meter's capabilities. The default program is just to test the unit at the factory. The flow meter's internal computer must always have something programmed into the unit, so that becomes the default program. Your flow situation will usually require other programming choices. The text provided with each screen explains the reasons for the various menu options.

2.2 Operation of the Display

The display is a two-line, forty character-per-line liquid crystal (LCD). It has a backlight feature for easy viewing in low light situations. The display has three different operating modes, normal, programming, and messages. In the normal mode, the display shows such things as level, flow rate, total flow, parameter measurement, etc. In the programming mode, the top line of the display shows each step as you work through the program while the bottom line shows the choices available for that step. In the message mode, the display provides instructional information, such as how to leave programming, or what to do if you have entered a number that is out-of-range.

Following is a "normal" display on the flow meter. This is typical of what the flow meter will display when it is in the normal operating mode and you are not programming it.

000004.78 CF	1.13 FT	16-MAR-94
1.03 CFS	(X X)	8:25:37

An interpretation of the numbers on this display would be as follows: Time and date will be replaced by pH/D.O. and temperature if you are using parameter sensing. The (X X) to the right of the time indicates letters that may appear from time to time on the 4230 Flow Meter.

The letter C appears when the flow meter is communicating with a remote computer (Flowlink applications only). The letter Z will appear when the flow meter is doing an auto-zero. The letter P will appear when the flow meter is purging the bubble line. The letters E or D will appear (Enable or Disable) when the Sampler Enable function (step 6) is programmed by condition. (Pro-

grammed by condition means that the flow meter will enable the sampler only when a certain condition or set of conditions, sensed by the flow meter, are met.)

<i>Total Flow</i>	<i>Current Level</i>	<i>Date (or pH/D.O.)</i>
<i>Flow Rate</i>		<i>Time (temperature)</i>

Following is a typical programming display on the flow meter: (One of the items in the second line will be flashing. The item flashing is the selection currently held in memory.)

TOTALIZED VOLUME UNITS
• CF •• GAL •• M3 •• AF •• L •• MGAL •

Following is a typical display providing instructional information:

CHANGES HAVE BEEN MADE IN STEP
PRESS '0' TO CONTINUE, PRESS '1' TO DISCARD

 Note

If you stop programming for more than two minutes, the flow meter will time out, and whatever is on the display, (message or program step) will revert to the “normal” display, shown previously.

The program consists of steps and substeps. The steps are listed on the flow meter front panel. Most steps contain several substeps. Generally, you need to complete all the substeps before stopping, or the flow meter will reject the changes you made for that step after it times out. There are some exceptions.

The flow meter keeps in memory any changes that you made for the finished steps (all substeps completed before stopping). Most steps not finished when you stop will return to the previous selection.

2.3 Keypad Functions

Programming is done on the flow meter's keypad in response to messages on the display. The following sections describe the function of each key.

OFF and ON – These two keys turn the flow meter off and on.

Go To Program Step – Pressing this key lets you go directly to a particular step without passing through all the steps of the program. The display will ask you to enter the number of the step you want to program. Enter the number by pressing one of the number keys. There are nine program steps, so numbers from one to nine are valid.

Exit Program – Press this key when you want to leave the programming mode and return to the normal operating mode.

Clear Entry – This key lets you return to the previous entry for a program step if you have changed the entry, but have not yet pressed Enter.

Enter/Program Step – This key has two functions. One is to enter a program selection into the flow meter's memory (Enter). The other is to step through the program (Program Step).

Print Program – Pressing this key makes the flow meter print out a complete list of the current program kept in memory.

Print Report – One of the functions of the flow meter is to print periodic reports of the activity recorded on the flow meter at regular intervals. The contents of these reports are defined in step 1. If you set up the flow meter to generate these reports, you can have a report printed at any time by pressing this key. The report will cover the time interval from the last scheduled report up to the time you press this key.

The flow meter will print the next report at the next scheduled time. If power fails for five minutes or more, the flow meter will print a report when power is restored that will cover the interval between the last report and the time that the power failed. The next report will cover the time from the power failure to next scheduled report time.

Chart Advance – Pressing this key causes the paper chart to advance through the printer at the fastest possible speed. Nothing will be printed while you press this key.

Chart Reroll – You can unroll the chart from the take-up roll to look at it by pulling it out with your hands. Pressing this key rewinds the chart onto the take-up roll.

Number keys – These keys let you enter numeric values into the flow meter.

Decimal Point – This key lets you enter a decimal point into a numeric value when programming. On flow meters equipped with the optional modem, you can use this character as a comma (delay) when entering telephone dialout numbers.

Arrow keys – These keys, referred to as the left and right arrow keys let you select a programming option by moving across the menus shown on the second line of the display.

+/- key – This key lets you enter a plus or minus to a quantity entered. Its most common use is in entering values for the equation, a method of flow conversion. On flow meters equipped with the optional modem, you can use this character as a dash when entering dialout numbers.

Manual Purge – This key lets you purge the bubble line on the 4230 at any time.

2.4 Programming Procedure

To begin programming the 4230, turn on the flow meter and wait for the display to settle. Then either press the **Enter/Program Step** key (generally referred to as **Enter**) or the **Go To Program Step** key.

The display will change to two lines of text; the first line describes the step you are programming, and the second line shows the menu choices available. One of the choices shown will

be flashing. The flashing indicates that this choice is the current one held in memory. If you are satisfied with this choice, just press **Enter**, and the flow meter will advance to the next step.

If you want a different choice from the one that is flashing, you can move across the display by using the **left** and **right arrow** keys. Each time you press the **right arrow** key, the flashing selection will move one position to the right. This will continue until the flashing is over the last selection.

From time to time you will notice an arrow that points to the right edge of the display. This indicates additional choices are available beyond what you can see on the display. By continuing to press the **right arrow** key, you can view these unseen options. After reaching the furthest option, the arrow will move to the left side of the display, indicating that there are options unseen to the left. These are the options you started with. If you want to go back to one of them, use the **left arrow** key until the option you need reappears.

When the desired selection is flashing, press **Enter**. The display will then automatically advance to the next step of the program.

All of the program steps contain several substeps that must be completed before you advance to the next program step. Some steps, like Reset Totalizer contain only a few substeps. Some steps will require the entry of a numeric value.

Program these steps by using the **number** and **decimal** keys to enter the correct value.

You can program most of the flow meter in the shop, rather than at the job site, with the exception of step 3, Adjust Level/Parameters. To set level, you must make an accurate measurement of the level in the flow stream and then enter that value. This can only be done at the job site.

If you are programming the flow meter for the first time, generally you will begin by pressing **Enter**, and start with **step 1**. If the flow meter has been in use and you only need to change the program, you would be more likely to use the **Go To Program Step** key. With this key, you can go directly to the program step you need to change, instead of having to step through every single screen.

If you change an entry and want to change it again, you can make the display revert to the original entry by pressing **Clear Entry**. If you have already pressed **Enter**, however, the new value will be in memory. To change it, press **Exit Program**. If you are in the middle of a program step with multiple substeps, the flow meter will display, "Changes have been made in step; press 0 to continue or 1 to discard." If you press **1**, the display will return to normal and the last step you were working on will revert to its previous selection. (Any program step you completely change before you exit will remain changed.)

You can re-enter the program with either **Enter** or the **Go To Program Step** keys. If you become confused while programming, the best suggestion is to press **Exit Program** and start over. Also remember that you can have the flow meter print

a complete list of your program choices by exiting the program and by pressing the **Print Program** key as soon as the display returns to the normal operating condition, displaying level and total flow, etc.

2.5 Description of Program Steps

The flow meter is programmed using the following steps:

1. Operating Mode
2. Flow Conversion
3. Adjust Level/Parameters
4. Reset Totalizer
5. Sampler Pacing
6. Sampler Enable
7. Alarm Dialout
8. Printer
9. Reports/History

The sections that follow provide a description of each of the program steps.

2.5.1 Operating Mode

Step 1, Operating Mode, determines how you set up the flow meter. In this step there are two choices: **Program** and **Setup**. Program advances you into **step 1**, and from there on you correlate the flow meter to the flow stream. Setup selects various basic “housekeeping” features for the flow meter. Here you determine the internal clock, site identification, measurement setup, hysteresis (see page 2-15), report contents, operation of the display backlight, and program lock. In Program, you select the units of measure the flow meter will use for the display, calculations, and reports.

 Note

If you choose NOT MEASURED for any selection, the flow meter will make no further reference to that value or function for the rest of the program, and you will not be able to activate that process or function later on unless you reprogram step 1.

If there is a feature or option you need that does not appear on your display when the manual says it should, return to **step 1** and make sure you have not inadvertently left it turned off in either the **Program** or **Setup** menus.

Selecting some features automatically excludes others. For example, selection of pH or D.O. excludes the other parameter, unless you use the YSI 600 Multi-Parameter Sonde, which measures pH, D.O., and conductivity at the same time.

This method keeps program size manageable and makes programming more efficient. By turning off unneeded features of the program early, you do not have to keep de-selecting those features over and over as you work through the program.

Consequently, you should choose carefully from the first step. We suggest you study the program first, then fill out the Programming Worksheets (in the back of the manual), and program the flow meter last, if you are unfamiliar with the unit.

2.5.2 Flow Conversion Type

Step 2, Flow Conversion Type, determines how the flow meter calculates flow rate and total flow. For the 4230, flow rate is calculated by knowing the measured level and (usually) the characteristics of a structure called a primary measuring device.

A primary measuring device is a structure placed in a flow stream through which the stream flows. These devices are made in a number of styles and sizes, but they all have one thing in common: For any type of primary measuring device there is a known relationship between the level in the flow stream ahead of the device and flow rate through the device. Consequently, after you measure level with the flow meter, it can calculate flow rate and total flow from the measured level, by consulting built-in look-up tables.

Information about many common primary measuring devices is provided in the *Isco Open Channel Flow Measurement Handbook*. This useful book provides formulas, flow rates at various levels, and values for maximum head, as well as much interesting descriptive material. This book is available on request from Teledyne Isco. If your installation uses a non-standard primary device, you should consult the manufacturer of the device for flow rates at given levels. The flow meter will then calculate a flow conversion for such a device on the basis of the manufacturers' data you enter as data points or an equation. In some instances, a nonstandard primary device could be supplied with a flow equation; you can enter that equation into the flow meter and the flow meter will calculate the flow rate from that equation.

Flow Calculations Without Primary Devices – However, it is not always necessary to have a primary measuring device. The 4230 Flow Meter can measure level and calculate flow without having any primary device installed in the flow stream. Sometimes the shape of the flow stream itself forms the primary device.

The **Manning** formula uses the shape of a pipe or channel and its slope to calculate flow in open (non-pressurized) pipes.

An accessory is available for the 4230 called the **Flow Metering Insert**. These inserts, used in round pipes of 6", 8", 10", and 12", form a primary device inside the pipe by restricting flow and measuring the level of the liquid backed-up behind the insert. The opening in the insert, either a smaller round opening or a V-notch that forms a weir, forms a primary device.

The conversion types available are WEIR/FLUME, MANNING, DATA POINTS, EQUATION, and FLOW METERING INSERTS.

You use **Weir/Flume** flow conversion when your primary measuring device is a weir or a flume. A weir is a wall or dam across the flow stream. Water must rise to the point where it flows over

the top of the wall. The measured level upstream of the device and the appropriate formula are used to calculate flow. Flumes differ from weirs in that there is no wall or barrier, but instead a restriction, typically a sharp narrowing or change in the slope of the channel that restricts the flow.

Again, the measured level of the stream at some point ahead of the restriction is used by the flow meter to calculate flow. In this flow conversion mode, the flow meter uses internal look-up tables for many common primary measuring devices.

An **Equation** is used when you have a non-standard primary device, or want to use different values from those programmed into the look-up tables of the flow meter. Equation uses the standard flow equation:

$$Q = k_1H^{P_1} + k_2H^{P_2}$$

Where Q equals flow rate; k1 and k2 are constants; H is level (or head), and P1 and P2 are the powers to which the two H terms are raised. (Your equation may not have the second term, in which case you would enter 0 for the second constant, k2.) Most common primary devices are supported in the flow meter's software, so generally you will not need this option. But it is available for those needing to enter their own values, or for those who have a nonstandard primary device for which an equation can correlate level and flow.

The **Manning Flow Conversion** uses the Manning formula to calculate flow in open or closed (non pressurized) gravity-flow situations based on slope, diameter, and roughness of the pipe. The Manning formula is named for its developer, Robert Manning, a 19th-century Irish civil engineer. There is no primary measuring device as such. Instead the pipe, with considerations for its slope and internal roughness, serves as the primary device. The 4230 Flow Meter can calculate flow in round pipes, rectangular, U-shaped, or trapezoidal channels based on this formula.

The **Data Points Flow Conversion** calculates flow based on a set of user-entered data points for a flow stream. Data consists of correlated level and flow measurements for the stream. Like the Equation method of flow conversion, this flow conversion is most commonly used where the primary measuring device is non-standard, but where tables of level and flow rate data are available from the device manufacturer. The 4230 has space for four sets of data with as many as fifty points per set. The flow meter then calculates flow from these data tables using a three-point interpolation.

Flow Metering Insert Conversion - The inserts are installed in upstream pipes and held with compressed air pressurizing a bladder. They are set from street level with a handle that can be extended as far as sixteen feet. The inserts contain a bubble line outlet and have an opening in the face that is either round or triangular. The 4230 reads the upstream level (the water backs up behind the insert) and calculates the flow through the insert from this measured level.

2.5.3 Adjust Level, Parameters

Adjust Level, Parameters calibrates the sensors that provide the flow meter with level and other information. In this step you set the level in the flow stream. First you measure the level, as accurately as possible. Then you enter this value with the numeric keys. Accuracy is important. **This measurement provides the basis for all subsequent flow calculations in the flow meter.**

The flow meter also has an input port for measurements other than level. This is the Parameter Port. Here you can sense such variables in the stream as temperature, pH (the acidity or alkalinity of a solution) and D.O. (dissolved oxygen) in the flow stream. You can have either pH with temperature, D.O. with temperature, or temperature alone. The port is not dedicated to a particular sensor, except through programming. You can change the sensor. For example, you can change from a pH probe to a D.O. sensor if you change the programming. Selection of either parameter will keep the other from appearing later on the menus. Note, however, that it is possible to measure several different stream conditions including pH and D.O. at the same time with the YSI 600 Sonde.

The YSI 600 Sonde – The YSI 600 Sonde is a multi-purpose, water quality measurement device. It is intended for use in research, assessment, and regulatory compliance. The sonde attaches to the modified RAIN GAUGE connector on the 4230. Flow meters having only a 4-pin rain gauge connector will not support the YSI Sonde. If you wish to upgrade your flow meter to use this system, contact the factory. Note that you can have both the YSI 600 Sonde and the Rain Gauge connected to the flow meter at the same time by using a special Y-connect cable.

The YSI 600 can measure the following water qualities: **dissolved oxygen (D.O.), conductivity, temperature, and pH.** Conductivity measurements made by the sonde can be used to calculate specific **conductivity, salinity, and total dissolved solids.** A brief description and specifications for the YSI 600 are printed in Section 4 (Accessories). You may also contact the factory or your Teledyne Isco representative. More information on the sonde is found in the YSI 600 Manual, shipped with each YSI 600 Sonde.

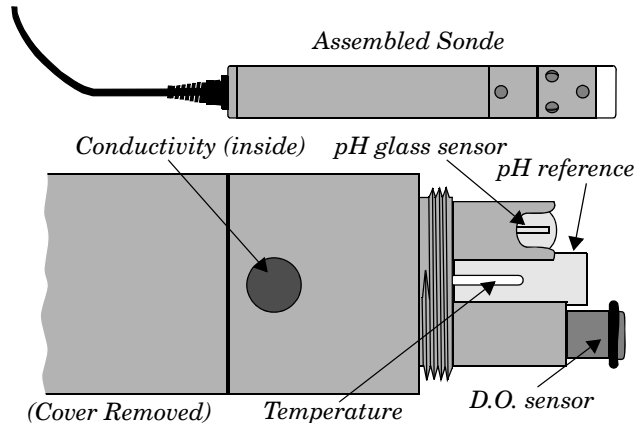

Figure 2-1 The YSI 600 Sonde

2.5.4 Reset Totalizer

In this step you decide whether you want to reset the flow meter's internal flow totalizers. If the installation is permanent you generally won't reset the totalizer. If you are using the flow meter as a portable recording unit and are moving it from one site to another, you generally reset the totalizer between sites.

2.5.5 Sampler Pacing

It is common to use a flow meter with a Isco sampler. Typically, the flow meter signals the sampler to take a sample after a certain volume has passed. This might also occur after a condition or set of conditions has either changed or been met. This step allows you to determine that control. There are several possible options—DISABLE, CONDITIONAL, VOLUME, and FLOWLINK. DISABLE will keep the sampler from receiving any flow pulses from the flow meter. VOLUME allows the flow meter to signal the sampler whenever a specific flow volume has passed. FLOWLINK (this option only appears if you are using Flowlink software), allows the sampler to be signalled from the flow meter as a result of conditions determined by Flowlink.

Note

If you choose CONDITIONAL for sampler pacing and it doesn't seem to work properly for you, read the section explaining hysteresis (page 2-15). Then check the hysteresis setpoints for your conditions. (The defaults are all zero.)

You must also have the appropriate sensors to measure temperature, dissolved oxygen, conductivity, or pH; the flow meter cannot do this by itself, nor does it occur automatically.

Flowlink is Teledyne Isco's proprietary data acquisition and management software. Flowlink works with personal computers, modems, and laptop computers to monitor flow meters from a distance. Consult the factory for more information.

VOLUME causes the flow meter to pace the sampler after a specific volume has passed through the flow stream.

CONDITIONAL allows pacing of the sampler by the flow meter when a particular condition has been met, or has changed. Among these conditions are changes in level, flow rate, temperature, rainfall, (if you are using the optional rain gauge), dissolved oxygen, or pH. You can also use a pair of conditions, or if you are using the YSI 600 sonde, you can select multiple conditions from its sensors.

2.5.6 Sampler Enable

Sampler Enable means that in a combination flow meter/sampler pair, the flow meter controls the sampler's ability to run its own program. The difference between **step 5**, sampler pacing, and **step 6**, sampler enable, is that in sampler pacing, the flow meter merely sends flow pulses to the sampler from time to time. The sampler counts these flow pulses to determine when to take a sample (according to its own programming).

With sampler pacing, the sampler is always enabled. With sampler enabling, the flow meter can actually stop operation of the sampler. The sampler is still set up to run its own program, but the inhibit/enable line from the flow meter will determine when and whether the sampler runs its program. This feature is useful for **storm water runoff** monitoring applications, where it may be necessary for the flow meter/sampler pair to have to wait a long time between storm intervals.

Again, changing or meeting a condition or set of conditions triggers the enabling. The conditions that can be used for sampler enabling are similar to those used for sampler pacing: level, flow rate, rainfall, temperature, dissolved oxygen, pH, or a combination of these conditions. The YSI 600 Sonde provides several measurements at the same time. You must have the appropriate sensors for rainfall, temperature, D.O., pH, and the YSI outputs.

2.5.7 Alarm Dialout Mode

This feature allows you to program a 4230 to signal a remote location through a telephone line. This feature is useful for transmitting alarm conditions or other essential information to a remote location.

 **Note**

You must have the optional modem installed to make use of this program step. The menus will not even appear unless the flow meter has a modem installed.

The Alarm Dialout feature is useful if you need to signal a remote location when there is a change of condition in the flow stream that could constitute an alarm. You can program as many as five different twenty-digit telephone numbers into the flow meter in decreasing order of importance. The modem is capable of speech.

DISABLE inhibits this function altogether. **CONDITIONAL** lets you program the flow meter to signal these alarms for a variety of reasons. You can use rainfall, time, level, flow rate, dissolved oxygen, pH, rate-of-change, a combination of conditions, or define the operation through Flowlink software from another computer. **STORM** lets you set the alarm through a combination of rainfall and time. You can also program the interval between calls and set up the system to reset the alarm condition by dialing back from the remote telephone.

2.5.8 Printer

The 4230 has a built-in printer. The printer is also capable of plotting linear data along with printing alphanumeric (letters and numbers) messages. In this step you set the speed for the chart to advance, from $\frac{1}{2}$ " to 4" per hour.

Chart speed is set according to the amount of resolution you want to see on the chart. If there is a great deal of activity on the chart, you would generally choose a faster speed so the marks are more "spread out" and are easier to interpret. If there is little activity on the chart and you want the flow meter to run for long periods without having to change the chart paper roll, you would probably pick a slower speed.

The flow meter is capable of plotting three separate data lines on the chart in addition to alphanumeric messages. These lines may indicate various things, such as level, flow rate, pH, dissolved oxygen, or temperature. You must have the appropriate sensors for pH, DO, and temperature to take advantage of the availability of these plots. Rainfall is printed as a bar graph.

The printer is capable of plotting over-ranges for the data lines it plots. You can tell when the printer is in over-range if a data line goes off the chart on the right side and then immediately starts over again plotting on the left side.

2.5.9 Reports/History

This step lets you program the flow meter to print out regular reports on the internal printer. The reports the flow meter prints are a summary of activity the unit records over a period of time. Typically included are such items as maximum and minimum flow rates, the time they were reached, sample records, etc.

The flow meter will let you create two separate reports, and let you define what appears on them to a great extent. Note that the contents of the reports are defined in Setup in **step 1**. **Step 9** merely lets you turn them off and on and set the timing. You can define the start time, the interval between reports and other aspects of the report.

History provides a record of changes made to the flow meter's program or operation events. As many as 50 changes can be stored in the flow meter's memory at a time. The memory can store up to 50 history items and 200 sample events at a time.

2.6 Interpreting the Program Screens

Following are the program screens as they appear on the display of a 4230. Explanations of most of the screens will be provided.

Note

Some items that appear in these menus will have parentheses (...) around them. This means that the item may or may not appear on your flow meter. Choices you make early in the program will make some options unavailable later.

An example of this is the pH/D.O. (Dissolved Oxygen) sensor option. Selection of either in **step 1** will keep the other from appearing in all following menus. If your installation does not use either sensor, you would select NOT MEASURED for both, and no further reference to either sensor would appear again for the rest of the program.

As you work through the program, your selections will rule out alternatives. This will cause those alternatives not to appear later in the program. Since there is no way of knowing what program choices will be made for a particular installation, it is necessary to provide all the *possible* menus in the manual, even though some of them will not appear on your instrument.

Note

This list does not include all possible screens for the unit, but does cover the screens found in a typical programming sequence. Some diagnostic and error screens are discussed in Section 5.

2.7 Step 1 - Operating Mode

Turn on the machine. Wait for the display to settle. Then press the **Enter/Program Step (Enter)** key. The following will appear (step 1). If the following menu does not appear, press **Exit Program**, then **Go To Program Step**, then press **1**.

```
SELECT OPTION
• PROGRAM •• SETUP •
```

PROGRAM is always the default. If you press **Enter**, the display will automatically advance to the next display, which will ask you to select units of measurement. If you select SETUP, the following will appear:

```
SETUP OPTIONS: 'EXIT' TO QUIT
• SET CLOCK •• SITE ID •• MEASUREMENT SETUP •
```

If you press the **right arrow** key, the following options will appear on the display:

```
SETUP OPTIONS: 'EXIT' TO QUIT
• STATUS •• ENABLE/ALARM HYSTERESIS •
```

Then:

```
SETUP OPTIONS: 'EXIT' TO QUIT
• OPTIONAL OUTPUTS •• REPORT SETUP •
```

And:

SETUP OPTIONS: 'EXIT' TO QUIT
• LCD BACKLIGHT •• (LANGUAGE) •• PROGRAM LOCK •

Finally:

SETUP OPTIONS: 'EXIT' TO QUIT
• (LANGUAGE) •• PROGRAM LOCK •• PROGRAM •

LANGUAGE may not appear on your unit. This is intended primarily for export models, as they are programmed in different languages. Flow meters will contain English and one other language, as ordered.

If you select SET CLOCK, the following will appear:

YEAR MONTH DAY HOUR MIN
XXXX XX XX XX XX

Enter the year (four digits), the month (01-12), the day (01-31), the hour (01-24), and the minute (01-59).

If you select SITE ID, the following will appear:

SITE ID: XXX

You can select any suitable three-digit number for the site identification.

If you select MEASUREMENT SETUP, the following will appear. You will have to use the **right arrow** key to bring all the options on screen:

MEASUREMENT SETUP
• DO/PH READING INTERVAL •• YSI 600 READING INT-

MEASUREMENT SETUP
-ERVAL •• PURGE INTERVAL •• SUPER BUBBLE MODE •

 **Note**

If you are using the Isco D.O. sensor or are sensing D.O. with the YSI 600 Sonde, select as long a measurement interval as is practical for your application. The reasoning is that the D.O. sensor is turned off between measurement intervals and this turned-off period prolongs the life of the sensor.

YSI 600 READING INTERVAL refers to the YSI 600 sonde. The flow meter can measure several different aspects of the stream at the same time, including pH, D.O., temperature, plus conductivity.

If you select PURGE INTERVAL, the following will appear:

PURGE INTERVAL
• 5 MIN •• 10 MIN •• 15 MIN •• 30 MIN •• 1 HR •

PURGE INTERVAL refers to how often the flow meter discharges a blast of air through the bubble line. These periodic blasts are intended to keep the end of the bubble line clear from any obstruction that could clog it, preventing it from releasing any bubbles. The option of setting the purge interval is offered for the sake of battery conservation.

If your bubble line shows a tendency to clog, characteristic of dirty flow streams, you should select a more frequent purge. If the stream is very clean and there appears to be no tendency to clog the bubble line, you could try a less frequent purge. However, if your installation is battery-powered, you should try to get by with less frequent purges to prolong the battery life. Some experimentation may be necessary to find the right setting for your installation.

If you select SUPER BUBBLE MODE, the following will appear:

```
SUPER BUBBLE MODE
• ON •• OFF •
```

Super Bubble is an Isco feature that increases the air supply to the bubble line when the flow meter senses a rapidly rising liquid level. This allows the level measurement to be more accurate and to change more quickly. In operation, Super Bubble resembles Purge in the way it forces a blast of air through the bubble line, but the effect is different. Without Super Bubble, there would be a period when no bubbles come out of the bubble line when the level rises suddenly. Until the bubble rate is re-established, the flow meter cannot accurately measure the level.

Super Bubble helps maintain accurate level measurement by filling the bubble line with air, thereby ensuring that the bubble rate will re-establish quickly when the level stabilizes.

Operation of Super Bubble will cause an increase in power consumption, because the air pump has to run. If your flow meter operates from AC power, leave Super Bubble on. If your installation is battery-powered and the flow is generally stable (without sudden increases), you can probably turn Super Bubble off. Again, some experimentation may be necessary.

If you select DO/PH READING INTERVAL, the following will appear:

```
DO/PH READING INTERVAL
• CONTINUOUS •• 15 SEC •• 30 SEC •• 1 MIN •• 2 MIN •• 5 MIN •
```

Again, this selection is offered as a means of saving battery power (and prolonging the life of the D.O. sensor. After selecting the appropriate parameter reading interval, press **Enter**. The Setup menu will reappear. This time, select YSI 600 READING INTERVAL from the menu. The following display will appear:

```
YSI 600 READING INTERVAL
• CONTINUOUS •• 15 SEC •• 30 SEC •• 1 MIN •• 2 MIN •• 5 MIN •
```

After selecting the appropriate parameter reading interval, press **Enter**. The Setup menu will reappear. This time select STATUS from the Setup menu. The following will appear:

```
4230 HW REV: XXXXXX SW REV X.XX  
ID XXXXXXXXXXXX
```

HW REV refers to the hardware revision number.

SW REV refers to the software revision number.

ID is an internal identification for the flow meter.

If you press **Enter** again, the flow meter will display the system voltage:

```
SUPPLY VOLTAGE: XX.X  
PUMP DUTY CYCLE XX.X%
```

The supply voltage should be from 10.5 to 13.5 (volts DC). PUMP DUTY CYCLE tells you how much the air pump is running. The value is refreshed every few minutes and should generally average below 20%. If you see a value consistently higher than this, check the bubble line, look for leaks, or check the air system inside the flow meter.

If you do not press **Enter** after the first diagnostic menu appears, the flow meter will automatically advance the display through the next two screens and finally revert to the Setup menu after a short time-out.

```
YSI SOFTWARE REV: XX.X
```

Return to the Setup menu if the unit has not already done so. This time select ENABLE/ALARM HYSTERESIS from the menu. The following will appear:

```
LEVEL ENABLE/ALARM  
HYSTERESIS X.XXX FT (or meters)
```

The HYSTERESIS menu lets you set the range over which the level (or other condition) can vary before the flow meter responds to the change.

In the PROGRAM section, there are several steps that require a change in a condition to make the flow meter carry out certain actions. For example, **step 6** programs the flow meter to enable (activate) a sampler. In that step, you select a condition (or set of conditions) that must occur before the sampler is enabled. You enter a value (level is an example) that must be met before the enabling occurs.

But what if this value is met briefly and then falls away? It is possible for a condition to vary rapidly over a narrow range. Without hysteresis, the flow meter would turn the sampler off and on repeatedly, causing a condition known as *chattering*, resulting in very erratic operation of the sampler.

With hysteresis, you can enter a value that will keep the flow meter from responding to small changes in the enabling condition. Select a value for hysteresis narrow enough to allow the

flow meter to respond to any significant change, but broad enough to ignore minor changes that could cause chattering. Press **Enter** again and the following will appear:

```
FLOW RATE ENABLE/ALARM
HYSTERESIS X.XXX CFS (Or other units of measure.)
```

The next three menus may appear or not, depending on selections you made earlier in Program. They concern alarm/enable hysteresis set points for parameter sensing—temperature, pH, and D.O.

If you want to set hysteresis for any of these items, you should enable them when you work through the program section, then re-enter the Setup section (Hysteresis) and they will appear. You can measure temperature alone, or temperature with either pH or D.O. You *cannot* measure either pH or D.O. without measuring temperature.

Note

You cannot measure pH and D.O. at the same time, and selection of one will prevent the other from appearing on the menus later.

The following will appear if you are measuring temperature:

```
TEMPERATURE ENABLE/ALARM
HYSTERESIS XX.XXX DEG F (or C)
```

The following will appear if you are measuring pH:

```
pH ENABLE/ALARM
HYSTERESIS X.XXX pH
```

The following will appear if you are measuring D. O:

```
DO ENABLE/ALARM
HYSTERESIS X.XXX PPM
```

(or mg./L. depending on units selected in Program.)

A set of menus similar to those shown above for pH, D.O., and temperature will then appear for the YSI 600 Sonde, if you have selected it. You can set hysteresis for YSI-pH, YSI-D.O., YSI-Conductivity, and YSI-temperature, if these parameters have been turned on in previous program selections.

2.7.1 Optional Outputs

After all the HYSTERESIS menus have been set, press **Enter**. The display will return to the Setup menu. This time select OPTIONAL OUTPUTS.

```
OPTIONAL OUTPUTS
•ANALOG OUTPUT ••SERIAL OUTPUT ••ALARM BOX •
```

ALARM BOX refers to an external accessory used to signal alarms from flow meter measurements. See Section 4 for more information. The choice of SERIAL OUTPUT will eliminate ALARM BOX as an option. Likewise, the choice of ALARM BOX will eliminate SERIAL OUTPUT as an option.

If you select any of these OPTIONAL OUTPUTS, the flow meter will request that you turn them on or off. If you are running on battery, select OFF for all unused outputs.

ANALOG OUTPUT refers to the flow meter's capability of managing associated equipment through a 4-20 mA current loop. The 4-20 mA current loop is a common method used to control industrial processes that are variable (rather than just fully off or on). At the lower value (4 mA) the control is turned off (0%); at 20 mA the control is completely turned on (100%). In between, rates range from 1 to 99%. A typical application is a chlorinator, which must vary in application of the chlorine gas as the amount of water passing through the system increases or decreases. Current ranges other than 4-20 mA are also in use, although they are less common than 4-20 mA. Examples are 0-20 mA (supported by the flow meter on the internal card only) and for longer current loops, 10-50 mA (not supported by the flow meter).

Teledyne Isco offers two different arrangements for the 4-20 mA control circuit. You can have either or both with the same flow meter. One arrangement requires the use of an external accessory, the 4-20 mA Output Interface (see Section 4). This module connects to the flow meter and a source of AC power and contains the circuitry necessary to create the 4-20 mA current loop. This accessory connects to the flow meter through the Interrogator connector.

The other 4-20 mA option is a board installed inside the flow meter that contains circuitry for up to three separate, isolated 4-20 mA current loops. This option can also be ordered with one or two current loops supplied. If you use both the external converter and the internal board, you can have a total of four current loops controlled by the same flow meter. The internal current loops are brought out to a 6-pin M/S connector in the slot where the Modem connector is usually mounted.

To activate the internal analog output(s), return to the main screen and press **4, 2, 0**.

ANALOG CAPABLE ('0' TO DISABLE) OUTPUTS 3 (EXIT PROGRAM WHEN DONE)

Additional information for the internal analog output board, including specifications for the loops, is found in Section 4.3.2.

The following menus determine the behavior of the 4-20 mA current outputs. If you select ANALOG OUTPUT (another term for the 4-20 mA Output) and the flow meter is equipped with the

optional internal board or the 4-20 mA external accessory has been turned on, RANGE, SMOOTHING, and MANUAL CONTROL will appear:

ANALOG OUTPUT • EXTERNAL 4-20 MA •• (RANGE) •• (SMOOTHING) ••
--

 CAUTION
--

Each 4-20 mA output represents a constant drain on the flow meter of at least 16 mA whether activated or not. While 4-20 mA applications are generally made in installations with commercial power available, Teledyne Isco suggests the following for those who have a 4-20 mA output in a battery-powered installation.

Use with battery powered flow meters only if:

- the battery is continuously on charge (for example with a Solar Panel Battery Charger)
- the battery is very large, such as a deep-cycle or marine type battery, or an Isco 35 Ampere-hour lead-acid battery.
- using only one 4-20 mA output.

Keep in mind that programming choices also affect power consumption. Use “minimum” settings on the flow meter wherever possible. (See Section 1, Table 1-9.)

Even with these circumstances, you may expect significantly shorter charge life from your battery. To determine the effect of this extra current draw on battery life, please refer to the section How to Make Battery Calculations, at the end of Section 1.

Programming for the conditions and values that determine the operation of the 4-20 mA loop (or loops) is done in Programming Step 2, following the entry of FLOW RATE AT MAXIMUM HEAD.

 CAUTION
--

If you do not have the proper hardware installed and you press 4 - 2 - 0 and the number of analog outputs is not zero, the external 4-20 mA converter will not work properly. If this occurs return to the 4 - 2 - 0 option, and at the prompt, enter 0 for the number of outputs activated. This will restore the external 4-20 mA converter capability.

MANUAL CONTROL will appear if you continue moving to the right. “RANGE” will appear with the ANALOG OUTPUT menu if the optional internal 4-20 mA converter is present in the flow meter. If you select RANGE, the following will appear:

OUTPUT RANGE
• 0 - 20 mA • • 4-20 mA •

This menu lets you select the current value for zero-percent (baseline) compatible with your equipment (internal 4-20 mA board only).

If you select SMOOTHING from the ANALOG OUTPUT menu the following will appear:

SMOOTHING
• NONE • • 15 SEC • • 30 SEC • • 1 MIN •

The SMOOTHING option lets you stabilize operation of the outputs by preventing a rapid reaction to sudden sharp changes in the condition being monitored that quickly return to normal (transients). Selection of a smoothing interval will prevent the equipment controlled by the 4-20 mA loop from reacting too quickly, too much, or operating erratically. A low-pass filter algorithm is incorporated in the software.

If you select the MANUAL CONTROL option from the ANALOG OUTPUT menu the following will appear:

MANUAL CONTROL (OUTPUT 0 = EXTERNAL)
OUTPUT 0 = 0.0 MA

This option lets you control the operation of a 4-20 mA loop to check the operation of equipment controlled by the loop at any level from 0 to 100%. After connecting a 4-20 mA output to a controlled device, you can program the flow meter to put a specified current on a specific analog output. If you are using the external 4-20 mA converter, the Analog Output number will be zero.

Note

Selecting the MANUAL CONTROL option and programming any one of the ports will prevent the values transmitted by the other active 4-20 mA ports from being updated until the test is completed. The other ports will continue to transmit whatever value they held at the start of the test. Exiting from the MANUAL CONTROL menu at the end of the test will return all active 4-20 mA ports to normal operation.

Programming for the conditions and values that determine the operation of the 4-20 mA loop (or loops) is done in Programming Step 2, following the entry of FLOW RATE AT MAXIMUM HEAD

2.7.2 Serial Output

Returning to the OPTIONAL OUTPUTS menu, you will see the SERIAL OUTPUT option. This feature lets the flow meter transmit the most recent values for all currently enabled ports as ASCII text. You can then write a simple program to retrieve this data periodically, or you can do it interactively using a terminal program.

 **Note**

The information in the following section is provided for those who can write their own software programs to process the data transmitted from the Serial Output port. Special cables may be required. Contact Teledyne Isco technical support for more information.

Command Line: (Use the INTERROGATOR connector.) The lines of text contain the port values for each port that is turned on. The DATA command will use a special command response protocol. The following table provides the ASCII codes for port types and standard units of measure.

Table 2-1 ASCII Output Codes		
Code	Parameter	Units
DE	Description	String
ID	Unit specific identifier	Unsigned long
MO	Model	String
TI	Time since 1900	Days
BV	Battery Voltage	Volts
LE	Level	Meters
LSI	Level Signal Strength	0 - 100%
FL	Flow	Cubic meters per second
VO	Volume	Cubic meters
FV	Forward volume	Cubic meters
RV	Reverse volume	Cubic meters
SV	Sampler Enabled Volume	Cubic Meters
RA	Rain (rolls over every 255 tips)	Tips
CR	Current day's rain (tips since midnight)	Tips
PR	Previous day's rain (tips since midnight)	Tips
PH	pH	pH units
DO	Dissolved Oxygen	Milligrams per liter
TE	Temperature	Degrees Celsius
YPH	YSI 600 pH	pH units
YDO	YSI Dissolved Oxygen	Milligrams per liters
YCO	YSI 600 Conductivity	Millisiemens per centimeter
YSP	YSI 600 Specific Conductance	Millisiemens per centimeter
YSA	YSI 600 Salinity	Parts per thousand

Table 2-1 ASCII Output Codes (Continued)

Code	Parameter	Units
YTD	YSI 600 Total Dissolved Solids	Milligrams per liter
YTE	YSI 600 Temperature	Degrees Celsius
YSP	YSI 600 Specific Conductance	Millisiemens per centimeter
YCO	YSI 600 Conductance	Millisiemens per centimeter
YSA	YSI 600 Total Salinity	Parts per thousand
YTD	YSI 600 Total Dissolved Solids	Milligrams per liter
YTE	YSI 600 Sonde Temperature	Degrees Celsius
SS	Sampler Enable Status	Logical
B?	Bottle Number and Time	Days
CS	Check sum (does not include the check sum, carriage return, and line feed)	Unsigned long
<p>Note: The output string for a given flow meter will have values only for those parameters it is currently measuring. The order of the fields in this table is subject to change. Additional data types may be inserted anywhere in the list. Parsing routines for this output string should search by type identifier instead of depending on the position in the string. If an active port has an error flag set, the serial output will insert ERROR for the value.</p>		

You can enter the command line by connecting the interrogator cable with the interrogator sense line shorted to ground. Then send a series of '?' (question marks) until the flow meter transmits the unit's banner and prompt. The number of question marks necessary is a function of the baud rate auto detection. At the prompt, enter DATA<CR> and the flow meter will respond with the appropriate ASCII output string. You can send the DATA command as often as you want. Type 'Q' to leave the command response interface.

In addition to the port values, the data includes the flow meter's current time, the bottle number and time stamp of the three most recent sample events, the previous day's rainfall total (midnight to midnight), the current day's rainfall total since midnight, and a rainfall tips counter that rolls over every 255 tips. (See **Rain Gauge**, page 4-8.) The port values appear in a comma-separated values format. Each data field is preceded by a two or three-character type identifier. The table lists the type identifiers. The flow meter's current time and the sample event

time stamp appear as a number in standard spreadsheet format (days since 1900). The supported baud rates are 9600, 4800, 2400, and 1200 (no parity, eight bits and one stop bit).

Periodic Output: (Use a special RAIN GAUGE connector cable—contact the factory for assistance.) Note that the periodic output will terminate during phone connection and when the interrogator cable is connected.

 **CAUTION**

It is important to use CHECKSUM if you plan to use internal modems or the interrogator. The UART is shared with these devices.

If you select SERIAL OUTPUT from the OPTIONAL OUTPUTS menu, the following display will appear:

```
PERIODIC SERIAL OUTPUT
• ON •• OFF
```

Selection of OFF from this menu will disable this feature, and there will be no further references to it.

The Serial Output data appears on the Interrogator connector of the flow meter. You should not use a standard interrogator cable for this application, as the sense line in the standard cable is shorted to ground.

Selection of ON from this menu will enable the feature and cause the following display to appear:

```
SELECT BAUD RATE (N81)
• 9600 •• 4800 •• 2400 •• 1200 •
```

After you select the appropriate baud rate, the program will advance to the following menu:

```
SERIAL OUTPUT INTERVAL
• 15 SEC •• 1 MIN •• 5 MIN •• 15 MIN •
```

This menu lets you select how often the flow meter transmits the ASCII text string.

Following is an example of a string showing all options:

```
DE,TheresaStreet,ID,0721577657,MO,4250,TI,35317.343715,BV,12.3,LE,0.1000,VE,0.1225,FL,0.001
555,VO,2.199325,FV,2.199325,RV,0.000000,SV,2.195539,SS,1,B0,35317.307384,B0,35317.269907,B0,
35317.232593,CS,10819
```

If you select any of these outputs, the flow meter will request that you turn them on or off. If you are running on battery and do not need these options, select OFF. Otherwise, select ON. After the OPTIONAL OUTPUTS menus have been set, press Enter. The display will return to the SETUP menu.

The alarm box, also called the High-Low Alarm Box, is an Isco product that allows you to operate control relays to signal alarms when flow rate rises above or falls below a certain set value. You can set both the high and low alarm values from 1 to 99% of the controlling condition. (See Section 4 for more information about the alarm box.)

Return to the SETUP menu.

This time, select REPORT SETUP.

```
REPORT SETUP
• REPORT A •• REPORT B •
```

This step lets you determine the contents of the reports generated by the flow meter. The flow meter's report generator is capable of creating two different reports (A and B) that can be identical or quite different.

The reason for two reports is to allow the summary of flow meter recording over different time periods. For example, you might generate report A weekly, and report B monthly. At this point we are only interested in selecting the items the flow meter will include in each report.

Press **Enter** and the following will appear:

```
REPORT SETUP
• FLOW •• DO/PH •• YSI 600 •• SAMPLE HISTORY •
```

FLOW METER HISTORY is just off the screen, to the right. If you select FLOW, the following will appear:

```
LEVEL IN REPORT
• YES •• NO •
```

Select YES if you want LEVEL to appear in the report.

```
FLOW RATE IN REPORT
• YES •• NO •
```

Select YES if you want FLOW RATE to appear in the report. Then:

```
RAINFALL IN REPORT
• YES •• NO •
```

Select YES if you want RAINFALL to appear in the report. You must have a rain gauge connected to the flow meter to sense rainfall occurrence. The following will appear:

```
REPORT SETUP
• FLOW •• DO/PH •• SAMPLE HISTORY •• FLOW MET...
```

FLOW METER HISTORY is just off the screen.

This time select DO/PH. The following will appear:

```
PH OR DO IN REPORT
• YES •• NO •
```

Select YES if you want DO/PH to appear in the report. You must have the appropriate sensor connected to sense parameters; the flow meter is capable of sensing temperature, pH and temperature, and D.O. (dissolved oxygen) and temperature. The following will appear:

```
TEMPERATURE IN REPORT
• YES •• NO •
```

Select yes if you want TEMPERATURE to appear in the report. Press **Enter** again and the display will return to the REPORT SETUP menu:

```
REPORT SETUP
• FLOW •• DO/PH •• YSI 600 •• SAMPLE HISTORY •
```

FLOW METER HISTORY is just off the screen.

This time select YSI 600. The following display will appear:

```
YSI DATA IN REPORT
• YES •• NO •
```

Press **Enter** again and the display will return to the REPORT SETUP menu.

```
REPORT SETUP
• FLOW •• DO/PH •• YSI 600 •• SAMPLE HISTORY •
```

This time select SAMPLE HISTORY. The following will appear:

```
SAMPLE HISTORY IN REPORT
• YES •• NO •
```

Select YES if you want SAMPLE HISTORY to appear in the report. Press **Enter** again and the display will return to the REPORT SETUP menu:

```
REPORT SETUP
• YSI 600 •• SAMPLE HISTORY •• FLOW METER HISTORY •
```

This time, select FLOW METER HISTORY. The following will appear:

```
FLOW METER HISTORY IN REPORT
• YES •• NO •
```

Select YES if you want HISTORY to appear in the report. HISTORY is a list of the changes that have been made to the flow meter's program.

Press **Exit** to leave the program. Then press **Enter** and reselect SETUP. The Setup menu will reappear:

```
SETUP OPTIONS: 'EXIT' TO QUIT
• STATUS •• REPORT SETUP •• LCD BACKLIGHT •
```

SET CLOCK, SITE ID, MEASUREMENT SETUP, PROGRAM LOCK, PROGRAM are off-screen and can be accessed with the arrow keys.

Select LCD BACKLIGHT with the arrow key. The following will appear:

```
LCD BACKLIGHT MODE
• KEYPRESS TIMEOUT •• CONTINUOUS •• OFF •
```

KEYPRESS TIMEOUT will cause the backlight to be turned on whenever you press a key on the keypad (other than On and Off). An internal timer is started that will keep the backlight on for approximately two minutes after you press a key.

Each time you press a key, the timer is restarted, so the backlight will never go off as long as you continue to program the flow meter, with keystrokes coming less than two minutes apart. At the end of programming, the backlight will go out, and will stay out until you start to program again.

This feature is designed to conserve battery power by de-energizing the backlight when it is not needed. The backlight is still available if it is necessary to program in a dark environment, such as a manhole. We recommend using this selection if the flow meter is battery-powered, but installed in an environment where the lighting is poor.

CONTINUOUS will cause the backlight to be lit continuously. Where the flow meter is powered by an AC power supply, battery life considerations do not intervene. If the backlight makes the display easier to read, use it. Do not use CONTINUOUS in any installation that is battery-powered, as it will cause rapid discharge of the battery.

OFF will keep the backlight feature turned off under all circumstances. Select this option for maximum battery life in installations where there is sufficient ambient light to read the display without the backlight feature.

Press **Enter**. The SETUP menu will return. This time move the flashing cursor from LCD BACKLIGHT to LANGUAGE.

When LANGUAGE appears on your display, you may select an alternate language to program the flow meter. The other language depends on how the flow meter was ordered. The following display will appear:

```
LANGUAGE
• ENGLISH •• (second language, as ordered) •
```

Select the language appropriate for your application. The menus and the printed reports will appear in the selected language. The SETUP menu will reappear. This time, select PROGRAM LOCK from the menu.

```
PROGRAM LOCK
• ON •• OFF •
```

PROGRAM LOCK keeps the program from being changed. Select OFF while you are programming, and then go back and select ON if you need to lock the program. At that, we suggest using the lock only if there are compelling security reasons.

Further changes will require entry of the password, which is the number of the flow meter, 4230. If you select ON, there is a time-out before the lock engages.

If you continue to work through the rest of the program, the lock will not engage until you are done. But if you stop programming longer than two minutes, the lock will engage, and you will not be able to make any further program changes.

 **Note**

If you choose NOT MEASURED for any selection, the flow meter will make no further reference to that function for the rest of the program, and you will be unable to activate that function later. If there is a feature you need that does not appear when the manual says it should, return to step 1 and make sure you have not accidentally left it turned off.

If you program a parameter value as a condition for sampler enabling, pacing, dialout, etc., and then turn that parameter sensor off, the flow meter will also remove that condition from the program. **Consider all aspects of your program before you make any changes.**

Press **Enter** and the SETUP menu will reappear.

Program:

SELECT OPTION
• PROGRAM • • SETUP •

PROGRAM will be flashing. (PROGRAM is always the default choice, because you are more likely to need to make changes in the PROGRAM section of the software than in the SETUP section.) The following will appear:

UNITS OF LEVEL MEASUREMENT
• FT • • IN • • M • • MM • • NOT MEASURED •

Selection of feet, inches, meters or mm depends on your situation. You would select NOT MEASURED if you were using the flow meter for some other form of sensing only, such as pH, or temperature. The following will appear. You will have to press the **right arrow** key several times to see all of the options displayed below:

FLOW RATE UNITS OF MEASURE
• GPS • • GPM • • GPH • • MGD • • CFS • • CFM • • CF-

Pressing the **right arrow** key several times will move other units onto the display:

FLOW RATE UNITS OF MEASURE
• CFH • • CFD • • LPS • • M3S • • M3M • • M3H • • M3D • • AFD • >

NOT MEASURED will also appear if you keep moving with the **right arrow** key. This step establishes the units of measure the flow meter will use in all subsequent displays and calculations. GPS = gallons per second; GPM = gallons per minute; GPH = gallons per hour; MGD = millions of gallons per day; CFS = cubic feet per second; CFM = cubic feet per minute; CFH = cubic feet per hour; CFD = cubic feet per day; LPS = liters per second; M3S

= cubic meters per second; M3M = cubic meters per minute; M3H = cubic meters per hour; M3D = cubic meters per day; AFD = acre-feet per day.

TOTALIZED VOLUME UNITS
• GAL •• MGAL •• CF •• L •• M3 •• AF •

This step determines the units value the flow meter will use to record the totalized flow volume that passes by. GAL = gallons; MGAL = millions of gallons; CF = cubic feet; L = liters; M3 = cubic meters; AF = acre-feet.

For the next several substeps you must have the appropriate sensor attached to the flow meter's Parameter Port or Rain Gauge Port (for the Rain Gauge or YSI 600 Sonde) to take advantage of the capabilities. You can only have D.O./temperature, pH/temperature or temperature alone on a given flow meter, unless you use the YSI 600 Sonde. The YSI 600 Sonde provides multiple outputs simultaneously. You can use the Rain Gauge with the YSI 600 sonde if you use a Y-connect cable.

Remember that programming for either pH or D.O. will prevent the display of any references to the other in later program steps. All sensors but the rain gauge must be fully submerged in the flow stream. The pH and D.O. probes must be kept constantly wet or they can be damaged.

The pH or D.O. probes cannot attach directly to the flow meter, as their output signals are low. You must also install the appropriate amplifier box between the probes and the flow meter.

Note

The 270 D.O. module has been discontinued. Probes, service kits, and accessories are still available to maintain existing field units.

Their use in streams with intermittent flow (such as storm drainage) is not recommended. See Section 4 (Accessories) for more information about the pH, D.O. probes, and rain gauge. The pH probe is a consumable item, and will eventually need replacement.

RAIN GAUGE
• INCHES •• MM •• NOT MEASURED •

You must have an Isco 674 Rain Gauge connected to the flow meter through the Rain Gauge Port to sense rainfall. MM = millimeters. The rain gauge is factory-calibrated. If you do not want to use a rain gauge, you would select NOT MEASURED for this step.

- If you choose NOT MEASURED, no further references to rainfall will appear in the rest of the program.

pH UNITS OF MEASURE
• pH •• NOT MEASURED •

pH measurement determines the relative acidity or alkalinity of a solution. You must have an Isco pH Probe connected to the flow meter through the parameter port to sense pH. pH measurements range from 0 to 14 pH units, with solutions below 7 considered acidic and solutions above 7, alkaline. Pure water has a pH of 7. The pH probe requires periodic recalibration for accurate sensing of pH. See Section 4 (Accessories) for more information about the pH probe. If you are not using a pH probe you would select NOT MEASURED for this step.

- If you choose NOT MEASURED for pH, you will be unable to activate pH later in the program.
- If you select pH, you will be unable to measure D.O. later in the program.
- If your situation requires the measurement of both pH and D.O. at the same time, or if you also need to measure conductivity, use the YSI 600 Multi-Parameter Sonde.

If you select NOT MEASURED for pH and press **Enter**; the following will appear:

D.O. UNITS • MG/L •• PPM •• NOT MEASURED •

Measurement of dissolved oxygen is conducted in studies of water quality in lakes and streams. Some dissolved oxygen is necessary for the survival of aquatic life in these waters. You must have an Isco Dissolved Oxygen Probe to sense dissolved oxygen. The probe attaches to the **Parameter Port**. PPM = parts per million; MG/L = milligrams per liter. If you are not using the D.O. probe, you would select NOT MEASURED for this step.

- Selection of NOT MEASURED will keep D.O. from appearing on subsequent programming menus.

Selection of PPM or MG/L will keep references to pH from showing up on subsequent menus.

TEMPERATURE UNITS • DEG F •• DEG C •• (NOT MEASURED) •

This step sets up measurement of the water temperature. You must have a Temperature Probe attached to the Parameter Port. The temperature probe contains a thermistor and needs no calibration.

Measurement is in degrees Celsius or degrees Fahrenheit. If you are not using the temperature probe, you would select NOT MEASURED for this step.

- Selection of NOT MEASURED will keep TEMPERATURE from appearing later.

If you are using either the pH or D.O. probe, temperature *must* be measured; the NOT MEASURED option will not even appear.

The following menus concern the use of the YSI 600 Multi-Parameter Sonde. This probe allows you to measure several characteristics of a flow stream at the same time. The YSI 600 Sonde attaches to the Rain Gauge connector. This connector must be a special connector with nine pins.

 **Note**

4230 Flow meters with 4-pin Rain Gauge connectors cannot support the YSI 600. It is necessary to return the flow meter to the factory for modifications. There are also significant internal modifications to the flow meter's electronics and software.

You can use both the YSI Sonde and a Rain Gauge on flow meters that support the YSI with a special Y-connect cable. The YSI 600 Sonde differs from the previously mentioned pH and D.O. probes. The YSI 600 can measure pH and D.O. at the same time, as well as temperature and conductivity.

If you are not using the YSI 600 sonde, select NO in the following display and the flow meter will advance to the next step. Otherwise, select YES.

YSI 600 CONNECTED
• YES •• NO •

- If you select NO, you will be unable to activate the YSI Sonde later in the program.

If no communication has been confirmed, the following display will appear:

YSI COMMUNICATIONS CHECK
• YES •• NO •

NO is the default. If you select YES, the following display will appear:

WARNING – DO NOT DISCONNECT POWER
YSI COMMUNICATION CHECK. PLEASE WAIT...

 **CAUTION**

Do not disconnect either the sonde or flow meter power during a communications check. The memory in the sonde can be damaged by a power failure during an update.

If the communication check is bad, the following display will appear:

COMMUNICATIONS CHECK FAILED
PRESS ENTER TO CONTINUE

 **Note**

The flow meter cannot communicate at 600 baud. If your sonde has been set up for 600 baud, you will get a communications failure. Consult the YSI 600 Manual for what to do in this case.

If the communications check is good, the following display will appear:

```
COMMUNICATIONS RATE SET AT 2400 BAUD
PRESS ENTER TO CONTINUE
```

After you press **Enter**, the flow meter will advance to the following display:

```
YSI 600 pH UNITS OF MEASURE
• pH •• NOT MEASURED •
```

- Selection of NOT MEASURED for any of the YSI menus will prevent you from activating those functions later in the program.

If you want the YSI 600 to measure pH, select pH. If you do not, select NOT MEASURED.

```
YSI 600 D.O. UNITS OF MEASURE
• MG/L •• NOT MEASURED •
```

If you want the YSI 600 to measure D.O., select MG/L. Otherwise, select NOT MEASURED.

```
YSI 600 CONDUCTIVITY PARAMETER
• YSI SP COND •• YSI SALINITY •• YSI CONDUCTIVITY •>
```

For any of the YSI CONDUCTIVITY options, if you press Enter, the following display will appear:

```
TEMPERATURE COEFFICIENT
1.91%
```

This value is provided because conductivity rises (~2%/ °C) with temperature. The default setting is 1.91%. This value is the temperature coefficient for pure KCl (potassium chloride) in water. For other salts this value will be somewhat inaccurate, but it does provide a close approximation for solutions of many common salts, such as NaCl (sodium chloride), NH₄Cl (ammonium chloride) and sea water. If you use the value of 1.91, in most cases you will be able to identify that gross changes are occurring in the ionic content of the stream. If you move with the right arrow, the following options will appear on the display

```
YSI 600 CONDUCTIVITY PARAMETER
• YSI T.D.S. •• NOT MEASURED •
```

T.D.S. stands for “total dissolved solids.” T.D.S. are measured in parts per thousand (ppt).

```
TDS SCALE FACTOR
0.75
```

Total dissolved solids are estimated by multiplying conductivity by an empirical factor. This factor can vary between 0.55 and 0.9 depending on the solubility of the ionic components in the water and its temperature.

YSI 600 TEMPERATURE UNITS
• °F • °C • • NOT MEASURED •

Select the units appropriate for your application.

2.8 Step 2 - Flow Conversion

FLOW CONVERSION TYPE
• WEIR/FLUME • • EQUATION • • MANNING • • DATA POINTS •>

METERING INSERTS will also appear.

WEIR/FLUME = weir or flume; EQUATION = equation; MANNING = Manning; DATA POINTS = data points. If you select WEIR/FLUME, the following display will appear:

TYPE OF DEVICE:
• WEIR • • FLUME •

For detailed information on weirs and flumes, refer to the *Isco Flow Measurement Handbook* that was shipped with your flow meter. Consulting the manufacturer of the specific weir or flume is also worthwhile. For weirs and flumes, there is a preferred location for installing the level measuring device. Proper mounting of the level measurement device and accurate measurement of the level in the flow stream at the calibration point are essential for accurate flow calculation by the flow meter. If you select WEIR, the following display will appear:

SELECT TYPE OF WEIR:
• V-NOTCH • • RECTANGULAR • • CIPOLLETTI •

If you select V-NOTCH, the following will appear:

SELECT V-NOTCH WEIR ANGLE (IN DEGREES)
• 22.5 • • 30 • • 45 • • 60 • • 90 • • 120 •

If you select RECTANGULAR for the type of weir, the following will appear:

END CONTRACTIONS ON RECTANGULAR WEIR:
• YES • • NO •

If you select YES, the following will appear:

RECTANGULAR WEIR WITH END CONTRACTIONS
ENTER CREST LENGTH XX.XXX FEET (or meters)

If you select CIPOLLETTI, the following will appear:

CIPOLLETTI WEIR
ENTER CREST LENGTH XX.XXX FEET (or meters)

If you selected FLUME for the type of standard device, the following display will appear:

SELECT TYPE OF FLUME
•PARSHALL •• PALMER-BOWLUS ••LEOPOLD-LAGCO •

Also available with the arrow key:

SELECT TYPE OF FLUME
• HS •• H •• HL •• TRAPEZOIDAL •

If you select PARSHALL, the following will appear:

SELECT PARSHALL SIZE:
• 1" •• 2" •• 3" •• 6" •• 9" •• 1.0' •• 1.5' •• 2.0' •

If you press the **right arrow** key several times, the sizes shown below will move onto the screen:

SELECT PARSHALL SIZE:
• 3' •• 4' •• 5' •• 6' •• 8' •• 10' •• 12' •

If you select PALMER-BOWLUS for the type of flume, the following will appear:

SELECT PALMER-BOWLUS SIZE
• 4" •• 6" •• 8" •• 9" •• 10" •• 12" •• 15" •• 18" •• 21" •

If you press the **right arrow** key several times, the sizes shown below will move onto the screen:

SELECT PALMER-BOWLUS SIZE
• 24" •• 27" •• 30" •• 48" •

If you select LEOPOLD-LAGCO for the type of flume, the following will appear:

LEOPOLD-LAGCO FLUME SIZE
• 4" •• 6" •• 8" •• 10" •• 12" •• 15" •• 18" •• 21" •

If you press the **right arrow** key several times, the sizes shown below will move onto the screen:

LEOPOLD-LAGCO FLUME SIZE
• 24" •• 30" •

If you select HS for the type of flume, the following display will appear:

HS FLUME SIZE
• 0.4' •• 0.5' •• 0.6' •• 0.8' •• 1.0' •

If you select H FLUME, the following will appear:

```
H FLUME SIZE
• 5' • .75' • 1' • 2' • 2.5' • 3' • 4.5' •
```

If you select HL FLUME, the following will appear:

```
HL FLUME SIZE
• 2.0' • 2.5' • 3.0' • 3.5' • 4.0' •
```

If you select TRAPEZOIDAL for the type of flume, the following will appear:

```
TRAPEZOIDAL SIZE
• LG 60 V • 2" 45 WSC • 12" 45 SRCRC •
```

(This completes the section on WEIR/FLUME flow conversions.)
Returning to **step 2**, SELECT FLOW CONVERSION: If you select EQUATION the following will appear:

```
ENTER EQUATION UNITS
Q = XXX.XXXH^X.XX + XXX.XXXH^X.XX
```

This step allows you to enter an equation that is appropriate for your flow situation. The equation is expressed in the general form of $Q = k_1H^{P_1} + k_2H^{P_2}$, where Q = flow rate, k1 = a constant, H = level or head, and P1 is the power to which H is raised. k2 and P2 are a second constant and power found in some equations. If your equation has only one term, you should enter 0 for the second constant.

Again returning to **step 2**, SELECT FLOW CONVERSION, if you select MANNING, the following display will appear:

```
SELECT MANNING TYPE
• ROUND PIPE • U-CHANNEL • RECTANGULAR • T-
```

TRAPEZOIDAL is also available, if you move to the right with the right arrow key.

If you select ROUND PIPE for the Manning flow conversion, the following displays will appear:

```
MANNING ROUND PIPE
SLOPE = X.XXXXXX ROUGH = X.XXXXX
```

Slope is entered as a dimensionless quantity, delta Y/ delta X, not as percent slope. Or, as otherwise expressed:

$$\frac{\Delta X}{\Delta Y} = \frac{\text{Rise}}{\text{Run}}$$

For example:

$$\frac{1}{100} = 0.01$$

Roughness coefficients are published in the *Isco Open Channel Flow Measurement Handbook*. You must know the material the pipe is made of. The roughness coefficients are published for all common materials in three grades: minimum, normal and maximum. Then:

MANNING ROUND PIPE DIAMETER = X.XXX FEET (or meters)

If you select U-CHANNEL for the Manning flow conversion, the following displays will appear:

MANNING U-CHANNEL SLOPE = X.XXXXXX ROUGH = X.XXX

(Slope and roughness are entered as for ROUND PIPE previously.) Then:

MANNING U-CHANNEL WIDTH = X.XXX FEET (or meters)

If you select RECTANGULAR for the Manning flow conversion, the following displays will appear:

MANNING RECTANGULAR SLOPE = X.XXXXXX ROUGH = X.XXX

(Slope and roughness are entered as for ROUND PIPE previously.) Then:

MANNING RECTANGULAR WIDTH = X.XXX FEET (or meters)

If you select TRAPEZOID for the Manning flow conversion, the following displays will appear:

MANNING TRAPEZOID SLOPE = X.XXXXXX ROUGH = X.XXX

(Slope and roughness are entered as for ROUND PIPE previously.) Then:

MANNING TRAPEZOID TOP WIDTH = X.XXX FEET (or meters)

Then:

MANNING TRAPEZOID
BOTTOM WIDTH = X.XXX FEET (or meters)

Returning to **step 2**, FLOW CONVERSION TYPE, if you select DATA POINTS, the following displays will appear:

SELECT DATA SET
• ONE •• TWO •• THREE •• FOUR •• (NONE) •

Then:

LEVEL UNITS FOR DATA POINT ENTRY
• FT •• IN •• M •• MM •

This allows you to enter data points that are in different units than you are using. Then:

FLOW RATE UNITS
• GPM •• GPS •• MGD •• CFS •• CFM •• M3S •• M3H •• M3D •

If you press the **right arrow** key a few times, the following units of measure will appear on the display:

FLOW RATE UNITS
• LPS •• CFD •• GPH •• AFD •• CFH •• CFM •• M3M •

GPM = gallons per minute; GPS = gallons per second, MGD = million gallons per day, CFS = cubic feet per second; CFM = cubic feet per minute, M3S = cubic meters per second; M3M = cubic meters per minute; M3H = cubic meters per hour; M3D = cubic meters per day; LPS = liters per second; CFD = cubic feet per day; GPH = gallons per hour; AFD = acre-feet per day; CFH = cubic feet per hour.

DATA POINT flow conversion allows you to enter measured level and flow rate values for a number of different points. The 4230 can accept as many as four sets of data points with each set containing up to fifty points.

The flow meter then performs a three-point interpolation to calculate a flow rate appropriate for the data entered. The common use of data point flow conversion is with unusual primary measuring devices, specifically devices that the 4230 does not support in its internal flow conversion set.

The level- to-flow rate data for such devices is usually available from the manufacturer. From this the flow meter can create a conversion based on the relationship between the level and flow rate.

After the FLOW RATE UNITS menu has appeared, the next menu is:

SET X (1-4): (0) POINTS ENTERED
• ADD POINT •• (UNITS) •

Then:

```
SET 1 DATA POINT 1
ENTER: 0.00 (level units) 0.000 (units of volume)
```

After you have entered the data point set the following will appear:

```
SET X (1-4): XX (1-50) POINTS ENTERED
•(USE)••EDIT POINT••ADD POINT••CLEAR••PRINT•
```

UNITS, SAVE will also appear if you move the flashing cursor with the right arrow key. USE will only appear after four points have been entered. USE tells the flow meter that the set is complete and can be used for the flow rate calculation.

Select EDIT POINT if you need to change either the level or the flow value for a particular data point.

Select ADD POINT if you want to add another point to a data set.

CLEAR will erase an entire set of data points from the flow meter's memory.

PRINT will make the flow meter print out the entire data set.

UNITS allows you to set or change the units of measure used in the data set. Note that you can only set UNITS if the set is empty, or you have cleared it. You cannot change the units once you have entered data points into a set unless you clear it and start over.

SAVE will save the data set as it is.

If you select either EDIT POINT or ADD POINT, the following display will appear:

```
SET X (1-4) DATA POINT XX (1-50)
ENTER: XX.XX (level units) XXX.XXX (volume)
```

2.8.1 Flow Metering Inserts

There is one more possible flow conversion for the 4230 Bubbler Flow Meter. This option will appear as FLOW METERING INSERTS. These devices are metal inserts for 6", 8", 10", and 12" diameter round pipe sewers. The inserts form a primary measuring device inside the pipe when they are placed. The inserts are installed from street level to a maximum depth of 16 feet with a handle made up of snap-fit extension pipes.

The inserts are sealed into the upstream pipe by inflating a rubber bladder. Each insert is supplied with two circular weir plates that provide either a round orifice or V-notch opening. Once installed, the flow backs up behind the insert and a bubbler tube in the bottom of the insert measures level.

The flow meter calculates flow based on this measured level. If you select METERING INSERTS for the FLOW CONVERSION mode, the following menu will appear:

```
SELECT WEIR/ORIFICE TYPE
• V-NOTCH •• ROUND •
```

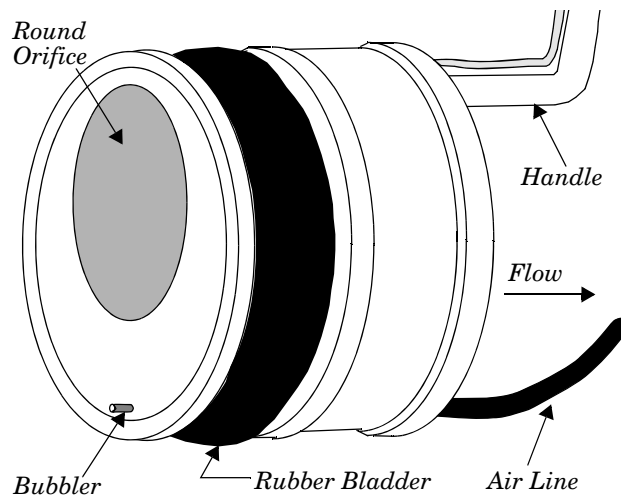

Figure 2-2 Flow Metering Insert

Then:

SELECT FLOW INSERT SIZE • 6" •• 8" •• 10" •• 12" •

2.8.2 Enter Maximum Head

Before advancing from **step 2** (Flow Conversion) to **step 3** (Adjust Parameters), the flow meter will request that you enter a value for Maximum Head (Level) for the device or flow conversion you are using.

For most standard measuring devices, this information is published or is available from the device manufacturer. Note, however that you should not arbitrarily use the largest value available. Instead, use the value that is the largest expected level for your actual situation, even if this is less than the published maximum.

The flow meter's internal resolution and its accuracy are based on the value you enter for Maximum Head. The flow meter will display:

FLOW RATE AT MAXIMUM HEAD X.XXX CFS (or other units of measure)
--

2.8.3 Programming the 4-20 mA Outputs

If you turn on any of the 4-20 mA outputs (ANALOG OUTPUTS) in **step 1** Setup, programming the actual operation of the output appears in **step 2** Select Flow Conversion.

Note

If you do not turn on the 4-20 mA output(s) in **step 1**, the menus determining its (their) operation will not appear later in the program. If you need this function and cannot find the appropriate menus in **step 2**, return to **step 1**, Setup and check to see that you have not inadvertently switched the option off.

For each 4-20 mA output port turned on, the flow meter will request entry of the type of data that will drive the output, along with minimum and maximum values. Here is an example of what you might see for programming analog output 1.

DATA TYPE FOR ANALOG OUTPUT 1 • (OFF) • (LEVEL) • (FLOW RATE) • (pH) •

TEMPERATURE, DISSOLVED OXYGEN, CONDUCTIVITY, SPECIFIC CONDUCTANCE, SALINITY, and TOTAL DISSOLVED SOLIDS may also appear as driving conditions.

The choices available to you will depend on what parameter measurements you have turned on previously and what accessories (YSI, pH, DO probes, rain gauge, etc.) you are using with your flow meter. After you select a choice, the flow meter will request the minimum and maximum values for that choice:

ANALOG OUTPUT 1 4 MA = X.X (units)

4 MA in the second line of the display could also be 0 MA if that is what you selected for the current loop minimum in Setup. The units are the units of measure appropriate for the option you selected; for example, feet or meters for level, degrees F or C for temperature, mg/l for dissolved oxygen, etc. After you have set the minimum value for the parameter, the flow meter will request that you enter a value for full-scale, or 100%:

ANALOG OUTPUT 1 20 MA = X.X (units)
--

This value causes the port to transmit 100% or 20 mA. For example, if the data type selected for this output were level, and the unit is measuring level in a four-foot pipe, you would enter a full-scale value of four feet. If the actual level reading is currently two feet, the analog output would read 12 mA (50% if the 4-20 mA current range is selected) or 10 mA (50% if the 0-20 mA current range is selected).

The flow meter will then request that you repeat the process of defining the data type and setting the minimum and maximum values for any of the other analog outputs you activated previously in Setup.

2.9 Step 3 - Parameter to Adjust

This step lets you enter the measured level in the flow stream. It also lets you calibrate the pH (acidity or alkalinity), D.O. (dissolved oxygen) parameter sensors, and the YSI 600 Multiple Parameter Sonde. There is no calibration step for the temperature sensor because it does not need calibration. When you select **step 3** the following will appear:

PARAMETER TO ADJUST • NONE • (LEVEL) • (pH) • (D.O.) • (YSI 600) •

LEVEL will not show up if you are using the flow meter only for parameter sensing. Likewise, pH and/or D.O. and YSI 600 will not show up on the display if you have locked them out by programming selections you made in **step 1**.

Remember that selection of either pH or D.O. in **step 1** will keep the other from appearing on the display in this or subsequent programming steps. If the parameter you want does not appear in this menu, exit the program and return to Setup. Check to see that you have not accidentally locked out your choice with selections made in the early part of the program. If you select NONE, the flow meter will advance to the next step. If you select LEVEL, the following will appear:

ENTER CURRENT LEVEL X.XXX FEET (or other units of measure, as selected)
--

For this value, you must measure the level in the stream (usually done with a measuring stick.) Generally, you should measure the level upstream from the bubble line outlet, or at the prescribed point in the primary measuring device. The bubbler should be installed in an area of stable flow.

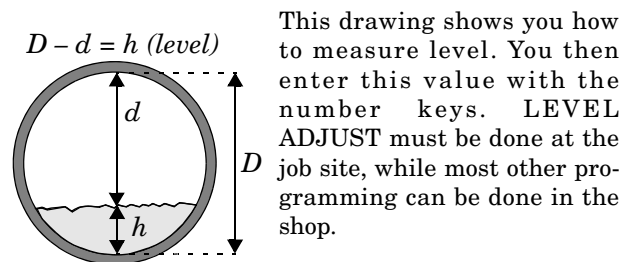

Figure 2-3 Level Measurement in Round Pipes

You should remove the bubbler and mounting ring to measure the level if either of the following occur:

- If it is not possible to measure the level upstream when the bubbler is installed, (cramped quarters inside smaller pipes).
- If the bubbler and its mounting ring create a visible “jump” in the stream.
This “jump” would be any noticeable disturbance on the surface of the flow stream where it passes over the bubbler and mounting ring, and is typical of lower flows.

Enter this value with the number keys. LEVEL ADJUST must be done at the job site, while most other programming can be done in the shop. Unless you have reliable information about the size of the channel, you should measure that, also.

Note

It is very important to enter accurate measurements for both the level in the stream and the dimension(s) of the channel, as all calculations of flow will be based on these measurements. If the values entered are incorrect, even by relatively small amounts, all subsequent flow calculations will be incorrect also.

For example, an error of only $\frac{1}{4}$ " for a 3" level and $\frac{1}{4}$ " for a 10" diameter round pipe can result in a combined error of over 14%!

Errors in level measurement have a greater effect on flow calculations at low liquid levels. Dimensional errors tend to be more significant at higher levels.

If you select pH for port to adjust, the following display will appear. (pH will not appear as an option unless you have selected it in **step 1**.) If you want to measure pH and pH does not appear in this step, you must go back to **step 1** and select pH instead of NOT MEASURED.

```
pH CALIBRATION
•pH 4 & 7••pH 7 & 10••pH 4, 7, & 10•
```

You can perform a two- or three-point calibration for pH with the pH sensor. Select the calibration that best suits your stream's profile. If the pH in your stream is generally below 7, you would probably select pH 4 & 7. If the pH is generally above 7, you would probably select pH 7 & 10. If your stream's pH varies a great deal, for example from 3 to 12, your best choice would be pH 4, 7, & 10. Then:

```
RINSE PROBE AND PLACE IN 4.0 pH SOLUTION
PRESS ENTER WHEN STABLE X.XX pH
```

The flow meter will direct you to repeat this process with the other standard buffers (7 and/or 10) to calibrate the pH sensor. If the probe fails to provide the correct output with any of the buffer solutions you will receive the following message:

```
pH BUFFER/PROBE OUT OF RANGE
PRESS ENTER TO CONTINUE
```

If you select D.O. for parameter to adjust, the following display will appear:

```
DISSOLVED OXYGEN CALIBRATION
•D.O. STANDARD••ABS BAROMETRIC PRESSURE•>
```

ALTITUDE is just off screen to the right. If you select D.O. STANDARD for the calibration method, the following display will appear:

D.O. STANDARD
0.00 MG/L

If you select ABS (absolute) BAROMETRIC PRESSURE the following will appear:

ABS BAROMETRIC PRESSURE
X.XX mmHg

Absolute barometric pressure is barometric pressure not corrected to sea level. The barometric pressure published by the U.S. Weather Bureau is corrected to sea level. If you use their value, you must convert it to the absolute pressure for your altitude. You should use Weather Bureau barometric pressure only if you are at sea level, or are able to correct the Weather Bureau figure to absolute pressure at your location. Enter the value for atmospheric pressure.

WRAP D.O. PROBE IN MOIST CLOTH
PRESS ENTER WHEN STABLE: X.XX MS/CM:

Then the display will advance to the following:

CALIBRATING...
PLEASE WAIT...

If you select ALTITUDE for D.O., the following will appear:

UNITS FOR ALTITUDE ENTRY
• FT •• M •

Select the appropriate units and press **Enter**.

ALTITUDE
ALTITUDE = X.XX FT (or meters)

Enter the altitude for your location. Then:

WRAP D.O. PROBE IN MOIST CLOTH
PRESS ENTER WHEN STABLE: X.XXX MG/L

For more detailed information on the pH and D.O. probes, see Section 4.

Returning to **step 3**, Parameter to adjust, the following display will appear:

PARAMETER TO ADJUST
• NONE •• (LEVEL) •• (pH) •• (DO) •• (YSI 600) •

Note

If you are using the YSI Sonde and YSI 600 does not appear on your display, return to **step 1**, Program, and make sure you have selected YES from the YSI CONNECTED menu.

If you select YSI 600, the following display will appear:

```
YSI 600 PARAMETER TO CALIBRATE
• NONE •• pH •• DO •• CONDUCTIVITY •
```

If you select pH for the parameter to calibrate, the following display will appear:

```
YSI 600 pH CALIBRATION
• pH 4 & 7 •• pH 7 & 10 •• pH 4, 7, & 10 •
```

You can perform a two- or three-point calibration for pH with the YSI sonde. The menus that follow are similar to those in the preceding section for the Isco pH sensor. Select the calibration that best suits your stream's profile. When you complete the pH calibration successfully, the following display will appear:

```
CALIBRATING...
PRESS ENTER TO CONTINUE
```

Returning to the YSI menu, if you select D.O.:

```
YSI 600 DISSOLVED OXYGEN CALIBRATION
• D.O. STANDARD •• ABS BAROMETRIC PRESSURE •>
```

ALTITUDE is just off screen to the right. Programming for YSI 600 D.O. is essentially the same as that described for the Isco D.O. sensor on the preceding section, with the exception that you always place the sensor in a cup, rather than wrap a moist cloth around it as is done for the Isco D.O. sensor.

If you select CONDUCTIVITY for the parameter to calibrate, the following display will appear:

```
CONDUCTIVITY CALIBRATION UNITS
• MS/CM •• PPT •
```

MS/CM is millisiemens per centimeter. The siemen is the S.I. (Système Internationale) name for the unit of conductance, which is also the reciprocal of the ohm. The siemen was formerly called the mho (ohm spelled backwards), and that term is more familiar to some. PPT is parts per thousand. Select the standard most suitable for your application.

```
CONDUCTIVITY STANDARD
X.XX MS/CM
```

Then:

PLACE PROBE IN X.XX MS/CM
PRESS ENTER WHEN STABLE: X.XX MS/CM

Then:

CALIBRATING...
PLEASE WAIT...

If you select PPT for the conductivity standard:

CONDUCTIVITY STANDARD
X.XX PPT

Then:

PLACE PROBE IN X.XX PPT
PRESS ENTER WHEN STABLE: X.XX MS/CM

Then:

CALIBRATING...
PLEASE WAIT...

There is no need to calibrate the YSI 600 temperature sensor, as it is self-calibrating. See Figure 2-4 for a YSI calibration flow chart.

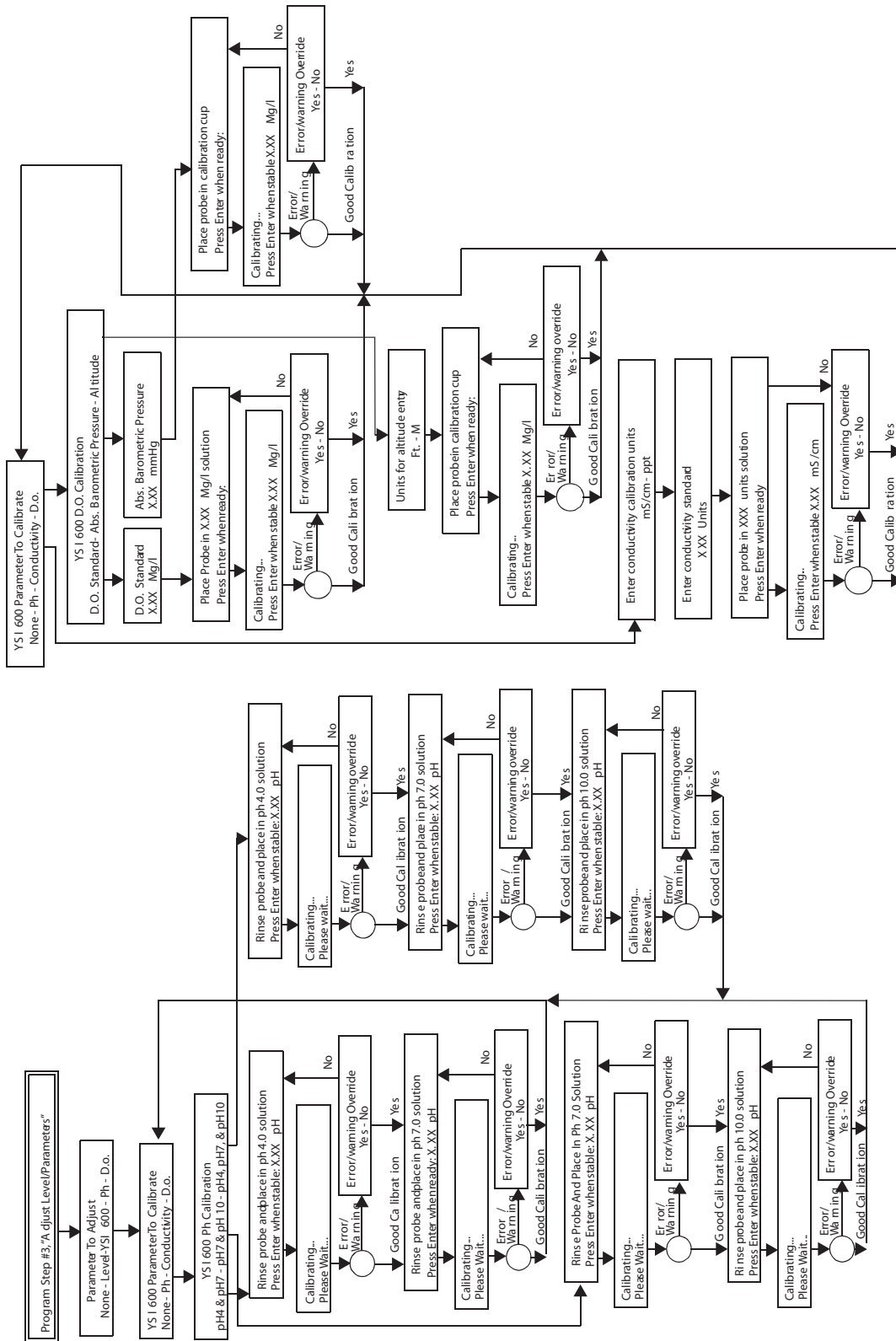

Figure 2-4 YSI 600 Sonde Calibration Flow Chart

2.10 Step 4 - Reset Totalizer

This step allows you to reset the flow meter's internal flow totalizer. Note that there is the possibility of more than one totalizer. All 4200 meters have the capability of maintaining a separate totalizer for the time the sampler is enabled through the sampler enabling feature (**step 6**).

If you select **step 4**, the following will appear: If you select NO, the flow meter will advance to the next step. If you select YES, the flow meter will reset the internal totalizer to zero.

```
RESET TOTALIZER
• YES •• NO •
```

Then, if you have sampler enabling turned on (**step 6**), the flow meter will ask you whether you want to reset the totalizer for the total flow during the time the sampler was enabled. (See **step 6** for an explanation of sampler enabling.)

```
ENABLE TOTALIZER XX CF
PRESS 'ENTER
```

(Other units of measure may appear.) Then:

```
RESET SAMPLER ENABLE TOTALIZER
• YES •• NO •
```

2.11 Step 5 - Sampler Pacing

This step determines how the flow meter will signal an associated automatic wastewater sampler to take a sample. The flow meter and sampler must be connected together with a cable. The flow meter sends flow pulses to the sampler. The sampler uses these flow pulses as counts. When an appropriate number of flow pulses has been received by the sampler, it will take a sample.

If you select **step 5**, the following will appear:

```
SAMPLER PACING
• DISABLE •• (VOLUME) •• (FLOWLINK) •• CONDITIONAL •
```

VOLUME will not appear if the flow meter is measuring level only, or is being used for parameter monitoring.

The FLOWLINK menu option will not appear unless Flowlink, Teledyne Isco's proprietary data acquisition and storage software, is installed and pacing has been downloaded from Flowlink.

If you select DISABLE for sampler pacing, the flow meter will be effectively disconnected from the sampler. The sampler will run its program as if the flow meter weren't there. Selection of DISABLE will also cause the flow meter to advance to the next program step. If you select VOLUME for sampler pacing, the following will appear:

```
SAMPLER PACING
ENTER PACING VOLUME XX.XXXX (units)
```

(Range is max. flow ÷ 10 to max. flow × 10,000)

If FLOWLINK appears for sampler pacing, the operation of sampler pacing has been determined by choices made in Flowlink software. Flowlink controls the flow meter remotely, via phone lines and a modem, or locally with a laptop computer and cable. In any event, if the sampler pacing definition is controlled by Flowlink, it can only be changed through Flowlink. If you select CONDITIONAL for sampler pacing, the following will appear:

CONDITION •(LEVEL)••(FLOW RATE)••(RAINFALL)••(D.O.)••(pH)•

(TEMPERATURE), (YSI pH), (YSI DO), (YSI CONDUCTIVITY) and (YSI TEMP) may also appear. Note that all the conditions shown above are in parentheses. Which ones actually appear depend on your previous programming selections. At least one of these menu options will be available to you. Pressing the **right arrow** key may be necessary to bring all items onto the display, (provided they are available for use.)

LEVEL will only appear if the flow meter is set up to measure level or flow. RAINFALL, D.O., pH, and TEMPERATURE measurement require the appropriate sensor probe be used with the flow meter. Remember that only one parameter condition (D.O. or pH) can be measured by the flow meter at a time.

RAINFALL can appear if you have a rain gauge attached to the flow meter. TEMPERATURE can be measured alone, or with either parameter probe.

D.O. and/or pH may not appear on the menu, depending on selections made in **step 1**. If you do not see the item you need, return to **step 1**, and recheck your programming. If you did not make the proper selections there, certain menu options will not appear here, as they would have been locked out. The YSI 600 conditions of pH, DO, CONDUCTIVITY, and TEMPERATURE will only appear on the menu if you have turned them on in steps 1 and 3.

For any of these conditions, you can set the point at which a change in the selected condition causes the flow meter to send a flow pulse to the sampler. The following menu will appear:

(Selected CONDITION) •GREATER THAN••LESS THAN••RATE OF CHANGE•

If you select GREATER THAN, the flow meter will ask you to enter a maximum value for the selected condition, which if exceeded, will trigger the flow pulse.

If you select LESS THAN, the flow meter will ask you to enter a minimum value for the selected condition. If the condition falls below that value later, the flow meter will send a flow pulse to the sampler.

If you select RATE OF CHANGE, the flow meter will request two values, one for the condition, and the other for a period of time over which the change occurs.

After you have determined what condition will signal the sampler and under what circumstances, the following menu will appear:

```
SELECT OPERATOR
• DONE •• OR •• AND •
```

SELECT OPERATOR allows you to trigger the sampler from a single condition or from two conditions. Suppose you wanted to trigger the sampler from only one condition and that condition was LEVEL. You would select level as the condition, and then identify what change in LEVEL would be the trigger. Then you would select DONE for the SELECT OPERATOR step. Selection of DONE will advance the flow meter to the next program step.

However, suppose you wanted to select two conditions, either of which would trigger the sampler. In such a case you would select OR for the SELECT OPERATOR step. The menu will return to the one listing the conditions. This will let you define the second condition. Now the flow meter will trigger the sampler when either condition changes.

Finally, suppose you had a situation where you wanted changes in two conditions to occur before you signalled the sampler. In that case you would select AND for the SELECT OPERATOR step. Then you would define the second condition. Now the flow meter will signal the sampler only after both conditions have changed.

The next screen on the flow meter (after you have established the conditions for sampler pacing) will request the following. (Entering 0 sends no pulses.):

```
CONDITION TRUE PACING INTERVAL
PACE EVERY X MINUTES
```

This option lets you send flow pulses periodically to the sampler when the conditions you established for sampler pacing are being met. Then:

```
CONDITION FALSE PACING INTERVAL
PACE EVERY X MINUTES
```

This option allows you to send flow pulses periodically to the sampler during the time the conditions you established for sampler pacing are not being met. Again, entering 0 sends no pulses.

2.12 Step 6 - Sampler Enable

The operation of **step 6**, Sampler Enable is similar to **step 5**, Sampler Pacing. The menus and options are similar. The difference is that where sampler pacing only causes the flow meter to send a momentary signal (flow pulse) to the sampler, sampler enabling actually controls an inhibit line to the sampler that can keep the sampler from running its program. Sampler enabling is useful where the sampler needs to remain idle for long periods of time, such as storm water runoff applications.

When you select or advance to **step 6**, the following display will appear:

SAMPLER ENABLE MODE • DISABLE •• ENABLE •• CONDITIONAL •• (STORM) •
--

(FLOWLINK) may also appear. The FLOWLINK menu option will not appear unless Flowlink software has been installed.

DISABLE means that the sampler will be permanently inhibited by the flow meter. This condition will remain until you change it in this program step, or if you are using Flowlink, until it is overridden by a command from Flowlink. Select the DISABLE option with care; it will make the sampler appear to be inoperative, and that could easily be misinterpreted as an equipment failure by someone not familiar with the programming of the flow meter.

ENABLE means that the sampler is permanently enabled, free to run its own program without any control from the flow meter. This condition will remain until you change this menu option, or until it is overridden by a command from Flowlink.

The STORM option will not appear unless you turned on rainfall measurement in **step 1**. STORM selection is what you use when you want to monitor storm water runoff. STORM enabling is really a combination of conditions. First, enter a value for LEVEL in the flow stream. Second, enter a value for RAINFALL. Third, enter an amount of time over which the rainfall occurs. Finally, you enter a time since the last rainfall. You must have an Isco Rain Gauge to measure rainfall. The following menus are the STORM sequence:

LEVEL GREATER THAN X.XXX FT (Or other units, as selected.)

Then:

RAINFALL AMOUNT X.XX INCHES (Or other units, as selected.)

Then:

RAINFALL TIME PERIOD • 15 MIN •• 30 MIN •• 1 HR •• 2 HR •• 4 HR •
--

If you press the **right arrow** key several times, the following times will appear:

RAINFALL TIME PERIOD • 6 HR •• 8 HR •• 12 HR •• 24 HR •• 48 HR •• 72 HR •
--

The intervals above are the periods of time over which the rainfall occurs. The amount of rain entered in the previous step and detected by the rain gauge must fall during the time interval chosen from this menu before the flow meter recognizes the event as a storm.

The next menu defines the interval that must pass between storm events.

TIME SINCE LAST RAINFALL
DAYS: *X* (allowable entry of 1-7)

If you select CONDITION from SAMPLER ENABLE, the following will appear:

CONDITION
• (LEVEL) •• (FLOW RATE) •• (D.O.) •• (pH) •

(TEMPERATURE), (RAINFALL), (YSI pH), (YSI DO), (YSI CONDUCTIVITY) and (YSI TEMP) may also appear. The above conditions are all shown in parentheses, because they may or may not be available to you by the time you reach this menu. The menus that do appear will depend on the flow meter type and programming selections made earlier in the program. At least one of the conditions will be available to you. If you select LEVEL from CONDITION the following will appear:

LEVEL
• GREATER THAN •• LESS THAN •• RATE OF CHANGE •

After you select one of these options, the flow meter will request that you enter a value, for example if you selected GREATER THAN:

LEVEL
GREATER THAN *X.XX* FEET (Or other units.)

Enter a maximum value for the selected condition, which if exceeded, will enable the sampler.

If you select LESS THAN, the flow meter will ask you to enter a minimum value for the selected condition. If the condition falls below that value later, the flow meter will enable the sampler.

If you select RATE OF CHANGE, the flow meter will ask you to enter two values, one for the condition, and the other for a period of time over which the change occurs.

After you have determined what condition will signal the sampler and under what circumstances, the following menu will appear:

SELECT OPERATOR
• DONE •• OR •• AND •

This step allows you to trigger the sampler from a single condition or from two conditions. Suppose you wanted to trigger the sampler from only one condition and that condition was level. You would select level as the condition, and then identify what change in level would be the trigger. Then you would select DONE for the SELECT OPERATOR step. Selection of DONE will advance the flow meter to the next program step. Selection of

OR or AND will allow you to select another condition, and then determine whether both conditions are necessary for enabling (AND) or whether either condition will enable the sampler (OR).

If you select FLOW RATE:

FLOW RATE • GREATER THAN • • LESS THAN • • RATE OF CHANGE •
--

You would select one of these options, and then enter a value, as for LEVEL, previously.

The rest of the menu will appear the same as they did for LEVEL and FLOW RATE. D.O., pH, TEMPERATURE, and RAINFALL all require activation in **step 1** and use of the appropriate sensor. Only one parameter condition (pH, D.O.) can be measured by the flow meter at a time. pH and D.O. will not appear on the display at the same time.

It is possible to program the Sampler Enable option so that it operates in two different modes, **latching** and **non-latching**. To explain this, in the non-latching mode the sampler will be enabled only as long as the condition that caused the enabling remains outside of “normal.” If the enabling condition returns to “normal,” the sampler enable will turn off until the next time the condition goes outside of “normal.”

In the latching mode, the sampler will be enabled the first time the condition goes outside of normal and it will remain enabled regardless of any subsequent changes in the enabling condition. If this is the case, the following menu will allow you to reset the sampler enable feature. This menu will not appear unless the condition necessary to enable the sampler has been met and the sampler is currently enabled.

WHEN ENABLE CONDITION IS NO LONGER MET • DISABLE SAMPLER • • KEEP ENABLED •
--

Or:

ENABLE CURRENTLY LATCHED, RESET • NO • • YES •

Select YES to reset the sampler enable feature; select NO to leave the sampler enabled.:

PRINTER ON/OFF WITH ENABLE • YES • • NO •
--

This selection allows you to turn the flow meter's printer on or off when the sampler is enabled from the flow meter. This allows you to conserve battery power and print a chart only when the sampler is enabled. This feature is useful for monitoring storm water runoff.

2.13 Step 7 - Alarm Dialout Mode

This step lets you signal an alarm to a remote location from the flow meter. The conditions that can cause an alarm are the same as described previously for sampler enabling.

Note

You must have the optional internal modem installed and connected to a telephone network to make use of this feature. This menu will not even appear if you do not have a modem. The flow meter will automatically advance to the next step.

More information about the modem can be found in Section 4. If you have the modem installed and select **step 7**, the following will appear:

```
ALARM DIAL OUT
• DISABLE •• CONDITIONAL •• STORM •• FLOWLINK •
```

If you select DISABLE, this option will be inactivated until you change the selection later. The program will advance to the next step. If you select STORM, the flow meter will request definitions similar to those for STORM in sampler enable. The following will appear:

```
LEVEL
GREATER THAN X.XXX FT (Or other units of measure.)
```

Followed by:

```
RAINFALL AMOUNT
X.XX INCHES (or other units of measure)
```

Then:

```
RAINFALL TIME PERIOD
• 15 MIN •• 30 MIN •• 1 HR •• 2 HR •• 4 HR •
```

If you press the **right arrow** key several times, the following times will appear:

```
RAINFALL TIME PERIOD
• 6 HR •• 8 HR •• 12 HR •• 24 HR •• 48 HR •• 72 HR •
```

The intervals above are the periods of time over which the rainfall occurs. The amount of rain entered in the previous step and detected by the rain gauge must fall during the time interval chosen from this menu before the flow meter recognizes the event as a storm.

The next menu defines the interval that must pass between storm events.

```
TIME SINCE LAST RAINFALL
DAYS: X (allowable entry of 1-7)
```

If you select CONDITIONAL for alarm dialout, the following will appear:

CONDITION
• (LEVEL) •• (FLOW RATE) •• (D.O.) •• (pH) •

(TEMPERATURE), (RAINFALL), (YSI pH), (YSI D.O.), (YSI CONDUCTIVITY), and (YSI TEMP) may also appear. As mentioned previously, some of these menu options may not appear depending on selections you made earlier in the program. At least one of the options will be available to you.

D.O., pH, TEMPERATURE, and RAINFALL all require activation in **step 1** and connection of the appropriate sensor to the flow meter. D.O. and pH will never appear together, as only one can be used at a time. When you have selected the condition you want, the display will advance to the following:

CONDITION
• GREATER THAN •• LESS THAN •• RATE OF CHANGE •

For these conditions, you enter an amount, which if exceeded (GREATER THAN), or if dropped below (LESS THAN), or if changed too quickly (RATE OF CHANGE), will activate the alarm dialout. For RATE OF CHANGE, you enter two values: amount and time interval over which change occurs. Then the display will advance to the following:

SELECT OPERATOR
• DONE •• OR •• AND •

As described previously for sampler enabling, this step allows you to combine conditions to produce an alarm dialout signal. Select DONE if you need only one condition to trigger the alarm.

If you want either of two conditions to trigger an alarm, select OR. If you want both of two conditions to be met before signalling an alarm, select AND. Selection of DONE will advance you to the next display menu. Selection of OR or AND will return you to the CONDITION menu to select the other condition.

The flow meter will then request that you enter the telephone numbers for the remote alarms. Five numbers are possible, in decreasing order of importance. You can enter as many as eighteen digits for each phone, so the targets need not necessarily be local.

ALARM DIALOUT NUMBERS
• DONE •• NUM 1 •• NUM 2 •• NUM 3 •• NUM 4 •• NUM 5 •

If you select DONE, the flow meter will advance to the next step. If you select one of the NUM entries, such as NUM 1, the following will appear:

FIRST PHONE NUMBER
XXXXXXXXXX

You can enter the phone numbers as straight multiple digit numbers, or you can use the +/- key to enter a dash as telephone numbers are often written. Pressing the . (decimal) key inserts a , (comma). If you want to signal more than one remote number at a time, the numbers are arranged in decreasing priority. NUM 1 carries the highest priority, followed by NUM 2 and so on. After you have entered the numbers, the flow meter will request:

DELAY BETWEEN DIALOUTS XX MINUTES

This is the time delay between calling the first number and calling the second, etc. This option gives you time to respond to an alarm before the flow meter dials the next number. Select a value between 1 and 99 minutes. Then the display will advance to the following:

CALLBACK TO DISABLE ALARM • YES •• NO •
--

Select YES if you want to be able to acknowledge the alarm condition in the flow meter by calling back. No message is spoken on this callback.

When the flow meter's modem detects the ring, it will answer and automatically reset the alarm. If there is no one available to answer an alarm, you can have the flow meter dial a paging service and then someone with a pager can call back to acknowledge the alarm.

To acknowledge an alarm from a touch tone phone; wait for the spoken message to complete; then press *-X-X-X. The X-X-X are the three digits of the site ID number.

2.14 Step 8 - Printer

This step sets up the operation of the flow meter's internal printer. This printer also functions as a plotter. The printer/plotter is capable of printing alphanumeric information (words and numbers), and at the same time, plotting linear data like flow, level, pH, etc.

The unit can print as many as three different data lines while it regularly records other printed information supplied from the flow meter. Program selections made in this step will determine the appearance of the printer/printer's chart.

The first menu will request the speed of the chart.

ENTER PRINTER SPEED • OFF •• 1/2"/HR •• 1"/HR •• 2"/HR •• 4"/HR •
--

If you select OFF, the printer will be disabled. No data will be printed on the chart. The flow meter will, however, still print reports if you activate that function in **step 9**. The choice made from the other speeds depends on the amount of data you need to record on the chart.

If you are recording from a relatively stable situation, are using only one data line, and you want to achieve maximum longevity for the chart paper roll, select a lower speed for chart advance.

On the other hand, if there is a great deal of activity in your installation, and you must use all three data lines, selection of a faster chart speed will probably produce a chart more easily read and interpreted.

After you select the printer speed, the flow meter will ask you to define what input you want depicted by printer LINE A. (The printer can print as many as three separate data lines at the same time.) The following display will appear:

```
INPUT FOR PRINTER LINE A
•(LEVEL)••(D.O.)••(FLOW RATE)••(pH)••OFF•
```

(TEMPERATURE), (D.O.), (YSI pH), (YSI D.O.), (YSI CONDUCTIVITY), and (YSI TEMP) can also appear. Remember that menus in parentheses may or may not appear due to previous program selections. Either pH or D.O. may appear, but not both. The various YSI options will only appear if you have enabled the YSI 600 option in **step 1**, previously. You must have the appropriate probes to sense these conditions for the flow meter. Select OFF, if you do not wish to use this line.

If you select pH, D.O., TEMPERATURE, or any of the YSI options the flow meter will request that you set limits that will serve as the bottom of the chart and the chart full-scale.

```
PRINTER LINE A BOTTOM SCALE
X.XX pH (or other condition, as selected previously)
```

You would enter here the lowest pH value you expect to see in your flow stream:

```
PRINTER LINE A FULL SCALE
X.XX pH (or other condition, as selected previously)
```

Enter here the highest pH value (or other condition) you expect to see in your stream. Note that selection depends on the range that you would normally expect to see. If your stream varies from 6 to 8 pH units, you would not want to enter 0 and 14 as limits. The chart resolution would be poor. You could enter 5 and 9 pH and still have good resolution if there were sharp deviations because of the availability of over-ranges in the flow meter.

Selection of OFF from the INPUT FOR PRINTER LINE menu will cause the printer to leave this line blank. Selection of conditions other than pH, D.O., TEMPERATURE, or YSI functions will result in a request that you enter the full-scale value for the condition being plotted. For example, if you selected LEVEL as a condition, the following would appear:

```
PRINTER LINE A FULL SCALE
X.XXXX FEET (or other units of measure, as selected)
```

The flow meter will automatically go into over-range if the data goes higher than the full-scale value you have selected. You can easily recognize over-range operation by the plotted line running off the right side of the chart and then immediately reappearing on the left side of the chart. Because of the over-range feature, you can set a full-scale value that gives you good resolution on the chart.

At the same time, the automatic over-range will prevent the loss of data if the plotted line rises past the full-scale point. For the other conditions, the full-scale units will be appropriate for what is being measured (D.O., pH, temperature, etc.) Note that the flow meter is capable of multiple over-ranges.

```
INPUT FOR PRINTER LINE B
•(LEVEL)••(FLOW RATE)••(D.O.)••(pH)••OFF•
```

(TEMPERATURE), (YSI pH), (YSI D.O.), (YSI CONDUCTIVITY), and (YSI TEMP) may also appear.

Again, just as for line A, you can select another condition to plot on the chart. The flow meter will request a full-scale value, or bottom and full-scale values. These values can differ from that entered for line A.

```
INPUT FOR PRINTER LINE C
•(LEVEL)••(FLOW RATE)••(D.O.)••(pH)••OFF•
```

(TEMPERATURE), (YSI pH), (YSI D.O.), (YSI CONDUCTIVITY), and (YSI TEMP) may also appear.

For line C, you can select yet another condition to plot on the chart. The flow meter will also request entry of a full-scale, or bottom and full-scale values, as for the previous two lines.

```
PLOT RAINFALL ON CHART?
•NO••YES•
```

You must have an Isco Rain Gauge connected to the flow meter to measure rainfall. Output is recorded in either inches or millimeters. There is only one over-range for rainfall.

2.15 Step 9 - Reports/History

This step lets you set up the flow meter to print periodic reports. The typical report contains such information as the period of time covered in the report, maximum and minimum levels, and when they occurred. You can define two different reports in this step. For example, this is used to provide weekly and monthly reports. You can choose the content of the reports by working through the menus in **step 1**.

When you go to **step 9**, the following display will appear:

```
REPORT GENERATOR A
•ON••OFF••(PRINT)•
```

If you select OFF, the program will advance to the next step, and there will be no report A generated. If you select YES, the following will appear:

```
REPORT A DURATION TO BE IN
•HOURS••DAYS••MONTHS•
```

After you select the units of time, the following will appear.

```
ENTER REPORT A DURATION
XX HOURS
```

DAYS or MONTHS could also appear depending on what you selected for the previous step. The time selected becomes the time interval that will be covered in the report. Then the flow meter will ask you when you want the first report printed:

```
PRINT REPORT A AT
YR: XXXX MONTH: XX DAY: XX HR: XX MIN: XX
```

Then:

```
REPORT GENERATOR B
• ON •• OFF •• (PRINT) •
```

The second report generator lets you program the flow meter to print two independent generator reports at different intervals, for example. This is useful for those who need both a weekly and a monthly summary of activity on the flow meter.

If you select OFF for this step, the program will advance to the next step, and there will be no report B generated. If you select YES, the following will appear:

```
REPORT B DURATION TO BE IN
• HOURS •• DAYS •• MONTHS •
```

Select the appropriate interval for this second report. After you select the units of time the following will appear:

```
ENTER REPORT B DURATION
XX HOURS
```

DAYS or MONTHS could also appear depending on what you selected for the previous step. The time selected becomes the time interval that will be covered in the report. Then the flow meter will ask you when you want the first report printed:

```
PRINT REPORT A AT
YR: XXXX MONTH: XX DAY: XX HR: XX MIN: XX
```

After you have entered the desired date for the first report, the program will advance to the following:

```
PRINT FLOW METER HISTORY
• YES •• NO •
```

The final step on the flow meter is HISTORY. This step presents a record of the programming activity on the flow meter that you can have printed on the printer. The flow meter keeps a record of certain programming changes and prints them out. If you select YES, the following will appear:

```
PRINT FLOW METER HISTORY
• PRINT SINCE LAST •• PRINT ALL •
```

If you press PRINT SINCE LAST, the flow meter will only print the changes that have occurred since the last print request. If there were no changes, there will be no print. If you select PRINT ALL, the flow meter will print all the changes it has in memory, as far back as 50 entries.

If you selected NO from PRINT FLOW METER HISTORY, the flow meter will advance to CLEAR HISTORY - YES, NO.

If you select NO again, the flow meter will exit programming and return to the normal display. If you clear the memory, previous programming changes will be erased, but the flow meter will again begin keeping track of changes the next time you change the program.

2.15.1 Flow Meter History Contents

D.O. ADJUSTED
pH ADJUSTED
LEVEL ADJUSTED
FLOW CONVERSION CHANGED
PLOTTER SPEED CHANGED
PLOTTER TURNED ON
PLOTTER TURNED OFF
TIME CHANGE FROM
TIME CHANGE TO
REPORT A CHANGED
REPORT B CHANGED
REPORT A TURNED ON
REPORT B TURNED ON
REPORT A TURNED OFF
REPORT B TURNED OFF
TOTALIZER RESET
INTERROGATED
SAMPLER ENABLED
SAMPLER DISABLED
ALARM ACKED BY #X
ALARM NOT ACKNOWLEDGED
YSI pH ADJUSTED
YSI D.O. ADJUSTED
YSI CONDUCTIVITY ADJUSTED

4230 Flow Meter

Section 3 Installation

This section contains instructions for installing the 4230 Flow Meter. There is also information on mounting methods, interconnection wiring, and the setup procedure.

3.1 Preparation for Use

Teledyne Isco ships the flow meter with a roll of paper installed and a default program entered into memory. You should familiarize yourself with the programming procedure and practice working through the program steps, so you become comfortable with programming the unit. With the exception of setting the level, you can program the unit in the shop, rather than on the job site, if you want. This is a good idea as it will minimize the possibility of dirt and contamination getting inside the flow meter.

3.1.1 Install Desiccant Canister

If the unit is new, you can install the desiccant canister. It is provided in the accessory package and looks like a small, flat can with little holes in it. Open the flow meter case lid. Note the small clamp that resembles a bottle cap opener located near the bottom right-hand corner of the case lid. Install the desiccant canister by pressing it under this bracket, with its viewing window lined up with the circular hole in the bracket. Make sure the clamp is fully engaged over the canister. The particles inside the desiccant window should be blue. If the particles are pink, the desiccant is saturated and you will need to regenerate the canister before using it. If the unit has been in use and has been returned for reprogramming, you should clean it and inspect it as outlined in Section 5 of this manual.

3.1.2 Install External Desiccant Cartridge

The desiccant cartridge snaps into the large metal clamp mounted on top of the cabinet. There is a short length of silicone tubing that attaches to a plastic fitting on the side of the cabinet. Attach the other end of the tubing to one end of the desiccant cartridge. Like the case desiccant canister, the material inside the external desiccant cartridge should be colored a definite blue. If they are violet or pink, you need to regenerate them. See Section 5. You will need to dump the particles out of the cartridges into a small heat-proof pan for regeneration; you cannot regenerate them inside the cartridge. The cartridge is plastic and will melt.

Venting the Desiccant Cartridge – If you suspend the flow meter over the flow stream and there is any possibility of accidental submersion, vinyl tubing, available from Teledyne Isco, should be attached to the vent on the end of the external desiccant cartridge and routed to a place higher than the maximum

possible level of the flow stream. This will prevent any water from entering the flow meter or the vent tube for the bubbler in case of accidental submersion.

 **CAUTION**

Do not operate the 4230 with a saturated desiccator cartridge. Moisture eventually will seep inside the unit causing unseen damage.

Operation in low temperature-high humidity environments is particularly risky. Moisture drawn into the pump will form ice, jamming the pump and ruining it.

Do not operate the flow meter with the door left open. Moisture will quickly saturate the desiccator. Dust may settle inside and damage the printer.

For maximum equipment life, inspect the desiccants regularly and regenerate them when necessary. Keep the lid closed and latched unless you are programming or servicing the flow meter.

3.1.3 Opening the Case

To access the flow meter keypad and internal printer, you must open the case. Do this by unlatching the two catches on the right side of the flow meter cabinet (as you face it) and opening the lid. Keep the flow meter lid closed and latched whenever possible. This will protect the internal components from dirt and moisture, and will prolong the life of the desiccator. A case left open will defeat the purpose of the seal by causing the desiccant canister to quickly saturate with moisture.

Dust will also settle inside the case, wearing the moving parts of the printer prematurely. Many flow meters are installed in damp environments. Moisture and fumes dispersed inside the case can form acids that will corrode the electronics.

3.2 Connection to a Power Source

The 4230 requires a 12 volt, direct current (12 VDC) power input. This power may come from various sources.

- Companion Isco Automatic Wastewater Sampler
- Isco AC Power Supply
- Isco Battery (lead-acid or nickel-cadmium) attached to the flow meter
- External 12 VDC battery, such as a deep-cycle marine, or RV type

3.2.1 Low Power Indication

When power to the flow meter falls too low for normal operation, the message POWER LOST/LOW BATTERY will appear on the display. When power is lost or falls below operating limits, the flow meter will stop accumulating data (if you are using Flowlink), and the printer will not print, but the battery-backed RAM will save stored data (if any) and the program selections for the flow monitoring program you have entered into memory.

3.2.2 Isco Sampler

If you are using the 4230 Flow Meter with an Isco Sampler in a flow-paced sampling system, you can power the flow meter from the sampler's battery or power supply. Connect the flow meter to the sampler with the 6-pin flow meter-to-sampler cable. Use the “Flow Meter” connector on the sampler and “Sampler” connector on the flow meter. The flow meter will then receive power from the sampler.

Under certain conditions, such as a “fast” setting on the printer chart speed, the flow meter will draw a significant amount of power from the sampler. While this is no problem for samplers and flow meters powered by AC, there could be problems with battery. In that case, it would be better for the flow meter to have its own battery.

 Note

Do not attempt to run a sampler from a power source installed on a flow meter. The sampler's pump draws heavy current, particularly on start-up. The connect cable cannot carry such currents. If you must use a single power source, always install it on the sampler.

3.2.3 Isco Nickel-Cadmium Battery

Teledyne Isco offers a 4-ampere-hour 12-volt rechargeable nickel-cadmium battery to power the flow meter. Teledyne Isco packages this battery specifically for use with Isco flow meters and samplers. Refer to the *Power Products Guide* accompanying this manual for detailed information about this battery and the procedure for charging it.

Install the battery on the top of the flow meter case, and attach its connector to the 12 VDC connector on the side of the flow meter. Place the battery with its cable pointing toward the right side of the cabinet. Secure the battery by stretching the two rubber draw catches on top of the flow meter until they slip over the two metal “U” brackets mounted on the ends of the battery case. Screw the battery connector into the top mating connector on the right side of the flow meter case.

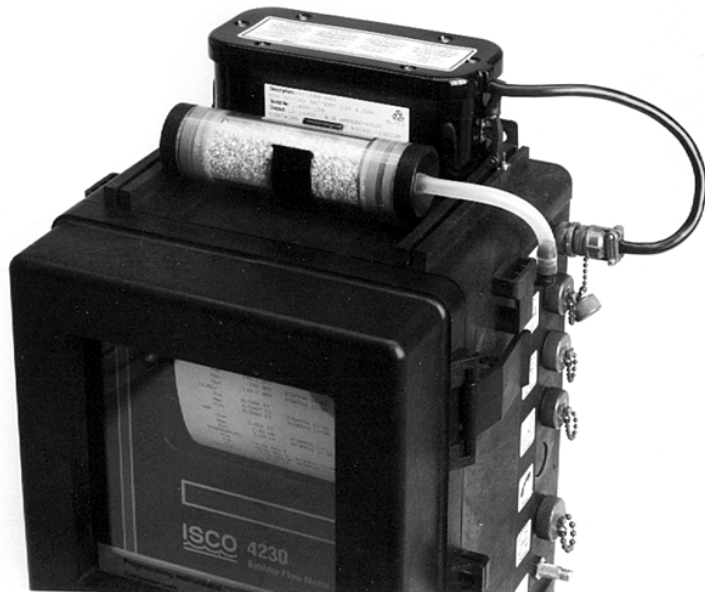

Figure 3-1 Battery Installed on Flow Meter

3.2.4 Isco Lead-Acid Battery

Teledyne Isco also offers a 6.5 ampere-hour 12-volt rechargeable lead-acid battery. This battery is similar in size to the nickel-cadmium battery, except somewhat larger, reflecting its greater capacity.

For those familiar with nickel-cadmium batteries, operation and maintenance of these batteries differs somewhat. Fewer charge-discharge cycles are possible, and a single deep discharge can ruin a battery. There is a linear voltage decrease as the battery discharges, while nickel-cadmium batteries show essentially the same voltage throughout discharge. Failure to recharge promptly can also ruin the battery.

Proper operation is necessary for normal service life. For more information on these batteries refer to the *Power Products Guide*. Please read that manual if you want to use lead-acid batteries.

Attaching the Isco Lead-Acid Battery – The lead-acid battery is installed the same as the nickel-cadmium battery. Place the battery on top of the case and secure it with the rubber draw catches. Attach the connector to the flow meter. If your flow meter is permanently installed, you may need to allow extra clearance above the flow meter for the slightly greater height of this battery.

CAUTION

Do not test any type of battery for its charge condition by “sparking” the output (shorting the terminals together with a screwdriver or other tool).

3.2.5 AC Power Supplies

Teledyne Isco offers two different AC power supplies, the High Capacity Power Pack and the Battery-Backed Power Pack to power the flow meter. These power supplies are designed for

operation on 120 VAC, 50/60 Hz commercial power sources. Alternate versions, designed for operation from 240 VAC, 50/60 Hz, are also available and are intended for export. Both have a line cord for convenient attachment to the AC power source, and are capable of operating the flow meter.

The Battery-Backed Power Pack provides 12 VDC at 5 Amps, and is backed by a 1.2 Ampere-hour nickel-cadmium battery. This power supply is built in a package the same size as the standard power supply, and is intended for use where short-term power interruptions are frequent, but unacceptable for flow meter operation. This power supply is also available in 120 and 240-volt versions.

Attaching the Power Supply – Mount the power supply on top of the flow meter cabinet the same as described for the battery. Secure the power supply with the two rubber draw catches pulled over the brackets on the ends of the case. Attach the short cable with the smaller connector to the top connector on the right side of the flow meter case. Connect the longer cord with the plug on it to an AC outlet. Refer to *Power Products Guide* for details concerning charging the batteries with the power pack.

3.2.6 External 12 Volt Direct Current Source

You can also power the flow meter from an external 12 VDC source, such as an automotive, motorcycle, or marine battery. Many people have found that a deep-cycle marine/RV battery is particularly well-suited to this application. However, you will have to mount batteries of this type externally, as they are too large to fit on top of the flow meter. Teledyne Isco offers a special optional connect cable to power the flow meter from a separate battery.

Mount the battery securely, in an upright position, so it will not inadvertently tip over, or have its cable easily pulled off. As advised previously for the nickel-cadmium battery, do not check the charge condition of lead-acid batteries by “sparking” the output cables (momentarily shorting the wires together).

 CAUTION
--

Be sure of proper polarity before attaching clips to the battery. Never attach the flow meter to a source of unknown polarity or voltage. If in doubt, check with a reliable DC voltmeter. Never attach the flow meter directly to an AC power source regardless of circumstances. Charge the battery in accordance with the manufacturer's instructions.

3.3 Bubble Rate

The Bubble Rate Adjust valve, located on the side of the case, is a “needle” type valve that controls the rate air is fed from the reservoir into the bubble line and the rate the bubbles are released into the flow stream. Turning the valve knob counterclockwise causes the bubble rate to increase. Turning the knob clockwise causes the bubble rate to decrease. Turning the knob clockwise until it stops will completely shut off the air supply to the bubble line.

 **CAUTION**

Do not use anything but your fingers to turn the Bubble Rate Adjust valve. The needle and seat inside the valve are very small and you can damage or break them if you use tools or force to close the valve. Once you have set the valve properly, do not overtighten the hex screw that locks the adjustment knob or you may strip the threads or ruin the Allen wrench.

3.3.1 Setting the Bubble Rate

The recommended bubble rate is approximately one bubble per second. For relatively clean flow streams, this bubble rate provides adequate sensitivity with reasonable power consumption. For flow streams with suspended solids (for example, domestic raw sewage or streams with a high grease content), two bubbles per second may help prevent plugging of the bubble line at the expense of higher power consumption.

3.3.2 Bubble Rate and Power Consumption

Power consumption by the flow meter's air pump is directly related to the setting of the bubble rate and the inside diameter of the bubble line. At one bubble per second, the $\frac{1}{8}$ " (0.32 cm) ID bubble line uses about $2\frac{1}{2}$ times more power for the air pump than does the $\frac{1}{16}$ " (0.16 cm) ID bubble line. Likewise, increasing the bubble rate from 1 to 2 bubbles per second causes a $2\frac{1}{2}$ times increase in power usage by the air pump.

The power the rest of the flow meter uses (except the printer) is constant and cannot be changed, but you do select bubble rate and bubble line size (as well as printer settings) and these items do significantly affect power consumption. If your installation must be battery-powered, consider the effect these factors have very carefully before setting up the flow meter. One indication of power consumption is the pump duty cycle. It should run less than 20%. You can check this value in the STATUS menu of the program.

Use caution when setting the bubble rate any higher than one bubble per second. For greatest accuracy in small channels, where you use either small ID tubing, or where the bubble line is long, Teledyne Isco does not recommend bubble rates over one bubble per second. When measuring low water levels (a few inches, typically) it is especially important to pay attention to the bubble line inside diameter, length, and bubble rate.

Setting a faster bubble rate causes an increase in frictional back pressure as a result of the tubing wall's resistance to increased air flow. For example, consider a 25 foot (7.6 m) $\frac{1}{16}$ " ID bubble line; the back pressure at one bubble per second is approximately equal to $\frac{1}{10}$ " (0.25 cm) of water. If you increase the bubble rate to 2 bubbles per second, the back pressure rises to approximately $\frac{2}{10}$ " (0.51 cm) of water, or *double* what it was at one bubble per second.

Another problem that occurs with long, small-ID bubble lines set at higher bubble rates, is that back pressure varies slightly during the period between air pump cycles. This will show up as

a change in level on the display, and it will generally also show up on the chart as a change in level. At the normal bubble rate this variation is not noticeable, but it will become noticeable if you set the bubble rate too high. For greatest accuracy in measuring low levels, use short bubble lines with the flow meter set at one bubble per second. If you need longer lines, use the $\frac{1}{8}$ " ID line rather than the $\frac{1}{16}$ " ID line.

3.3.3 Purging a Clogged Bubble Line

When you use the 4230 to measure levels in small channels, it is best to keep the bubble rate at one-per-second and use shorter bubble lines. Larger-ID bubble lines are less likely to clog than small ones, but require more energy to supply the additional air needed.

In applications where bubble line clogging is likely to be a problem, using the 4230 Purge feature (increasing the frequency of the automatic purge) may be a better solution than increasing the bubble rate. However, turning on the Purge feature will also cause an increase in battery consumption.

3.3.4 Adjusting the Bubble Rate

Make the initial setting of the bubble rate at the shop, rather than at the job site. At the shop you can put the bubble line in a container beside the flow meter and watch the rate while you adjust it. You can, of course, set the bubble rate at the job site if you wish, but it is easier with clean water in a clear container beside the flow meter.

To set the bubble rate:

- Connect the flow meter to a power source and turn it on.
- Turn the valve knob all the way clockwise so no air is escaping.

Allow some time for the system to pressurize. (The pump motor will stop running when the system reaches the correct operating pressure.)

- Attach a bubble line to the barbed Bubble Line fitting on the side of the case.
- For best results, use the same size bubble line you expect to use for the installation.

Setting the bubble rate with a large ID line and then connecting the flow meter to a small ID line will produce a much faster bubble rate than you want. Attach the 50-foot vinyl line directly to the barbed fitting by pressing it over the barbs. To attach the Teflon tube, press it into a short length of silicone tubing. Then press the other end of the silicone tube over the barbed fitting.

- Put the free end of the bubble line in a small container of water. Set it near the flow meter so you can watch the escaping bubbles as you turn the valve knob.
- Turn the valve slowly counterclockwise until bubbles start coming out of the end of the tube.
- Adjust the knob to achieve a rate of one bubble per second.

- Lock the adjustment knob by tightening the hex screw in the handle; do not over-tighten it. You will strip the hex screw.

 **Note**

Always recheck the bubble rate after you have installed the flow meter. This is particularly important if you install the bubble line under several feet of water. Since you set the rate with the bubble line under only a few inches of water, it may change if you install the line in a deep channel.

3.3.5 Locking the Bubble Rate

If you want to prevent accidental readjustment of the valve after you have set it, you can lock the valve knob in place. Do this by tightening the smaller of the two hex set screws on the valve's handle with the 0.035" hex socket key included in the flow meter's accessory package.

Be sure to loosen this screw before attempting to readjust the position of the valve. Failure to do so may score the valve core or strip the screw head.

3.3.6 Effects of Changing the Bubble Rate

Changing the bubble rate may cause a change in the indicated level. Air flow through the relatively small diameter bubble line generates a frictional back pressure or head in the bubble line. For a given bubble rate, this frictional head is constant and creates a fixed level offset for which level calibration automatically compensates. However, increasing the bubble rate a significant amount (for example, from one to two bubbles per second) will cause an increase in the frictional head and a consequent increase in the indicated liquid level.

- Always set the bubble rate before you adjust the liquid level reading on the flow meter.
- If you change the bubble rate for any reason, check and compare the readings between the real level in the flow stream and the indicated levels on the flow meter.

Adjust the indicated level if necessary. Since the friction head generated at a given flow rate is a function of the bubble line length and ID, you can minimize these frictional effects by using the shortest length of bubble line possible.

3.3.7 Super Bubble

The 4230 features an electronic "Super Bubble" feature that detects a rapidly-rising liquid level and temporarily increases the bubble rate to respond correctly to the rising level. Due to a higher friction head generated by the increased bubble rate during this operation, the flow meter will hold the indicated liquid level constant until the bubble rate returns to normal.

3.4 4230 Mounting and Installation

Because the 4230 Flow Meter is a portable device, it may or may not be permanently installed. You can suspend the flow meter in temporary installations, such as sewers, or mount it permanently in other installations, such as treatment plants, at your option.

3.4.1 Carrying Handle

To assist in carrying the flow meter, a handle is provided in the instrument's accessory package. To use the handle, snap the hooks at both ends into the two metal brackets at the top of either side of the flow meter case.

3.4.2 Location of the Flow Meter

Because it uses a bubble line, the 4230 Flow Meter does not have to be mounted directly above the primary device, or particularly close to the flow stream. You will need to mount the unit within 25 feet (7.6 m), or 50 feet (15.3 m) if you are using the 50 foot bubble line. Distances greater than 50 feet are not recommended.

The 4230 does not have any special requirements for mounting. It may be located on any relatively flat surface either horizontally, supported by the two mounting pads and the stainless steel mounting bracket, or vertically, supported by the two plastic rails on the bottom of the case. The flow meter may also be panel mounted, using the mounting bracket on the top rear of the case or suspended from a ladder rung or hook using the optional handle.

3.4.3 Safety Considerations

In field installations of 4230 Flow Meters and associated equipment, the safety of the personnel involved should be the foremost consideration. No project is so important or deadline so critical as to justify the risk of human life. Refer to the appendix on working safely in manholes and avoiding hazardous gases; found at the back of this manual.

 WARNING
--

The 4230 Flow Meter has not been approved for use in “hazardous locations” as defined by the National Electrical Code.

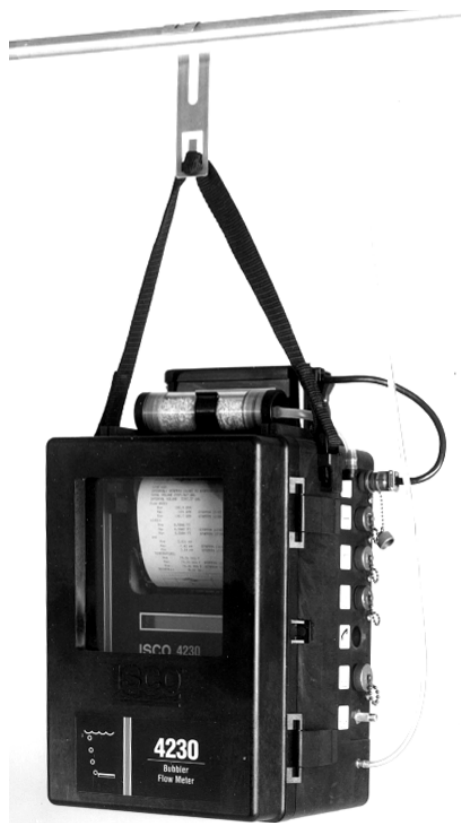

Figure 3-2 4230 Suspended by Handle (handles may vary)

3.5 The Bubble Line

Anchor the bubble line in the flow stream at the appropriate measuring point in the weir, flume, or other open channel flow situation. Air slowly bubbles out of the line into the flow stream. The pressure in the bubble line is proportional to the liquid level in the flow stream, and the flow meter measures this pressure, sensing the liquid level.

3.5.1 Standard Bubble Lines

Two different bubble lines are available for use with the 4230:

- $\frac{1}{8}$ " (0.32 cm) OD, $\frac{1}{16}$ " (0.17 cm) ID, Teflon® line, 25 feet long (7.6 m).
- $\frac{1}{4}$ " (0.63 cm) OD, $\frac{1}{8}$ " inch (0.32 cm) ID, vinyl line, 50 feet long (15.2 m).

You can specify either line at the time you order the unit. Teledyne Isco ships the bubble line in the flow meter's accessory package, and Teledyne Isco offers replacement lengths.

3.5.2 Comparing Vinyl and Teflon Bubble Lines

The vinyl line has two significant advantages over the Teflon line. First, the vinyl line has a longer usable length than the Teflon line. This is due to the small inside diameter of the Teflon tubing, which generates an undesirable friction head at lengths greater than 25 feet. And second, experience has shown that the larger ID vinyl line is less likely to clog than the Teflon line when used in flow streams with suspended solids (for example, domestic raw sewage or streams with a high grease content).

However, the smaller ID Teflon line also has advantages. First, since it has a very small inside diameter, the air volume necessary (and, as a result, battery power) is minimized, a definite advantage for battery-powered installations. And second, almost nothing attacks the Teflon line, while certain chemicals may attack the vinyl.

In general, Teledyne Isco recommends that, wherever practical, you use the **vinyl** line. Practice has shown that this line usually results in more trouble-free operation. Furthermore, if the distance between the flow meter and the measuring point exceeds 25 feet, you *must* use the vinyl bubble line. However, if power consumption is critical, or there are known agents in the flow stream that might attack the vinyl line, you should use the Teflon line.

3.5.3 Bubble Line Length

No matter which line you use, Teledyne Isco recommends you make it as short as possible. This will minimize friction head effects in the line and will also minimize the amount of line exposed to cuts, kinks, etc. Shorten the line as necessary by cutting the tubing with a sharp knife.

Long Bubble Lines – For certain applications (for example, where it is necessary to exceed the 50-foot length of the bubble line, or where the flow stream is extremely dirty and the end of the line may clog), you may need to use a bubble line with an inside diameter larger than either of the two standard lines.

Consult the factory for specific recommendations regarding size of line, special connectors required, etc. In no case should the inside diameter of the bubble line exceed $\frac{1}{4}$ " (0.64 cm), and you should recognize that a larger bubble line will result in increased power consumption, a concern if you must power the flow meter by battery. You should keep the bubble rate at one to two bubbles per second, regardless of bubble line size.

3.5.4 Teflon Line Connector

The Teflon bubble line attaches to the flow meter with the Bubble Line fitting on the side of the case and the silicone rubber tubing connector. The tubing connector is a short length of 0.109 inch (0.20 cm) ID, 0.192 inch (0.49 cm) OD silicone tubing attached to a barbed fitting on the case.

The $\frac{1}{8}$ " OD bubble line simply slips inside the silicone tubing, forming a reliable union you can make and unmake without tools. This type of tubing connector is superior to a ferrule or compression type tubing fitting for this application due to its simplicity of use (no tools required), its lack of small parts you can easily lose or misplace (ferrules and nuts), and its long term reliability when used with the semi-rigid bubble line Teflon tubing.

3.5.5 Attaching the Teflon Bubble Line

To attach the Teflon bubble line, first slip the 2 inch (5.1 cm) length of $\frac{1}{4}$ " (0.63 cm) ID vinyl tube included in the instrument accessory package over the end of the bubble line. Grasp the silicone tube to stiffen it and insert the end of the bubble line into the silicone tube.

Slip the short length of vinyl tube over the union and force in onto the shoulder of the barbed fitting. The purpose of the short length of vinyl tube is to support the union, preventing fatigue or kinking of the silicone tube.

To remove the bubble line from the tubing connector, first pull the vinyl tube off of the barbed fitting and slip it down the bubble line. Grasp the end of the silicone tube and then pull the bubble line straight out of the silicone tube.

Several replacement lengths of the silicone tubing are included in the instrument accessory package. Install them on the unit by simply forcing the end of the tube over the barbed tubing connector.

 **Note**

Avoid placing too much tension on the silicone tube where it attaches to the barbed fitting. Try to direct the Teflon tube straight away from the fitting rather than at a sharp angle. This will reduce the likelihood that the tubing will tear and leak around the fitting.

3.5.6 Attaching the Vinyl Bubble Line

The vinyl bubble line attaches directly to the barbed fitting. Remove the silicone tube and slip the $\frac{1}{8}$ " (0.32 cm) tubing over the fitting.

3.5.7 Installing the Bubble Line

Install the bubble line at the recommended level measuring point in the primary device or other open channel flow situation. If you don't know where this is and you are using a manufactured primary device, consult the manufacturer.

If you are not using a fabricated device, consult the *Isco Open Channel Flow Measurement Handbook* for suggestions. Many different devices are discussed there. Proper location of the bubble line outlet is necessary for accurate measurement. Normally, you place the bubble line in the flow stream so the end is positioned at a right angle to the flow.

You do not need to locate the outlet of the bubble line precisely at the "zero" liquid level of the weir or flume. The Parameter to Adjust program step of the 4230 allows you to locate the outlet end of the bubble line anywhere within ten feet (3 m) above or below the actual zero level of the primary device. Then you calibrate the displayed level using the Parameter to Adjust step in the program.

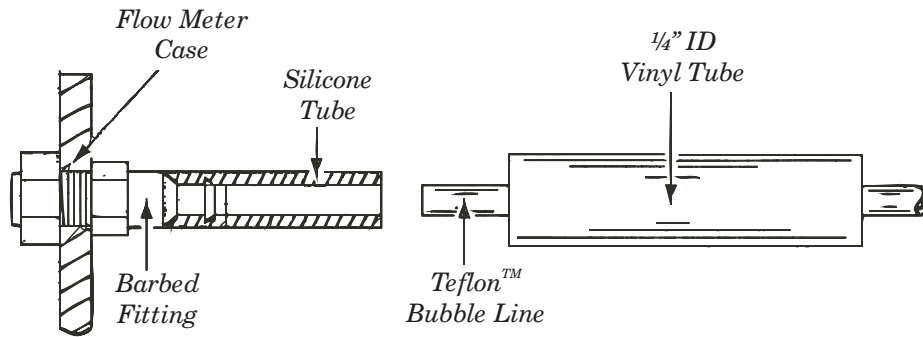

Step 1

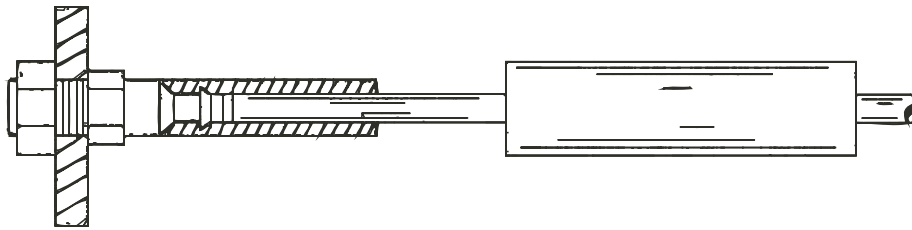

Step 2

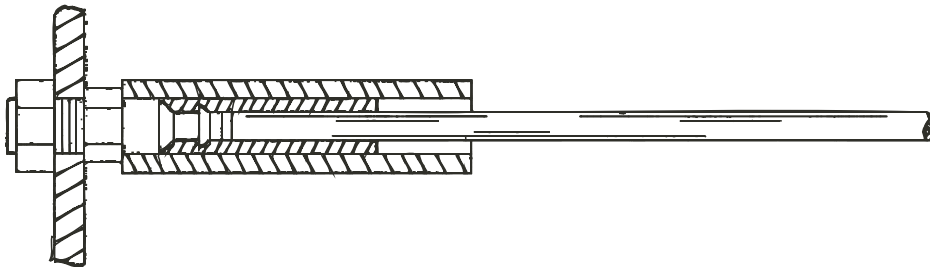

Step 3

A. 1/8" OD x 1/16" ID Teflon™ Bubble Line

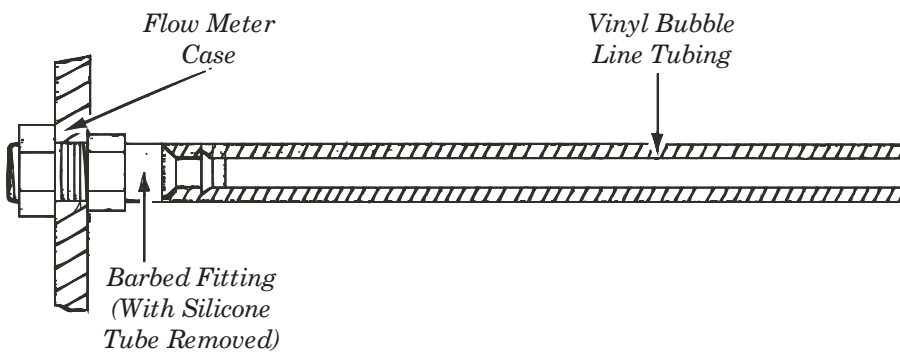

B. 1/4" OD x 1/8" ID Teflon™ Bubble Line

Figure 3-3 Attaching the Bubble Line to the 4230

Note

The 4230 cannot accurately measure liquid levels that are even with or below the bubble line outlet.

If you need to measure the liquid level down to the actual "zero" level of the primary device, Teledyne Isco recommends placing the bubble line outlet at least 1 to 2 inches (2.5 to 5.1 cm) **below** the primary device zero level to avoid measurement failures when the liquid level is even with the outlet. Since the flow meter can display negative measurements, you can compensate when you set the level in the flow meter.

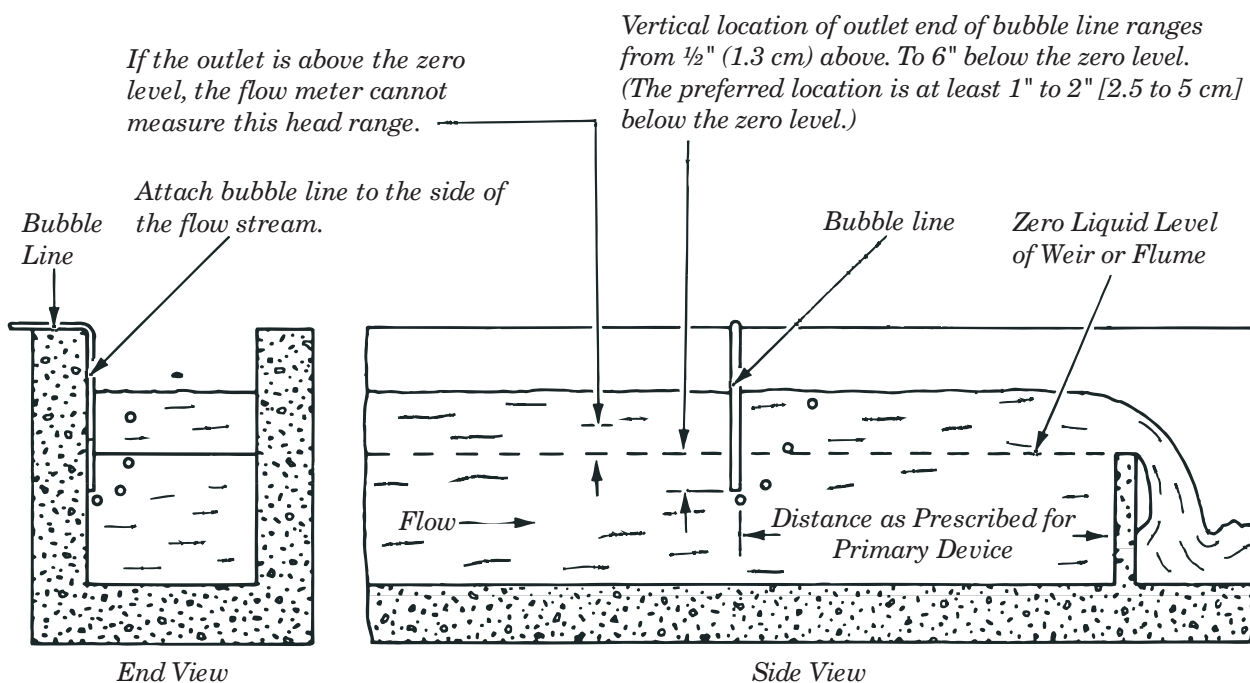

Figure 3-4 Positioning the Bubble Line in the Flow Stream

3.5.8 High-Velocity Flow Streams

The normal position of the bubble line in the flow stream is at a right angle to the flow. However, studies have indicated that at relatively high flow stream velocities (greater than five feet per second [1.5 meters per second]), this location may lead to a measured level lower than actual. This negative level offset is due to localized areas of low pressure near the bubble line outlet; the size of the offset depends upon the velocity of the flow stream and the configuration of the flow stream channel. You can, of course, adjust the level at the flow meter to compensate for the error. However, this is only effective if the flow rate and velocity are essentially constant. If the flow rate drops and the velocity decreases, the level adjustment you made earlier will be incorrect for the new, lower velocity and flow rate.

The best way to overcome this problem is to completely isolate the bubble line from the flow stream velocity by placing it in a stilling well, as described below. If this is not possible, you can perhaps create a cavity in the bottom of the channel, and locate the outlet of the bubble line in the depression, again isolating it from the flow stream velocity.

In flow streams carrying large amounts of solids, however, this may cause problems because of silt collecting in the depression, restricting the bubble line. A third alternative is to put a 90 degree bend in the end of the bubble line, forming a horizontal leg approximately two inches (5 cm) long, and orienting this horizontal leg downstream, parallel with the flow. Tests have shown that this orientation of the bubble line minimizes the effect of flow stream velocity.

3.5.9 Stilling Wells

If the installation includes a stilling well in the primary measuring device, you should probably install the bubble line in the stilling well. Attach the line securely to the stilling well, using stainless steel and/or plastic mounting hardware.

For details on the construction and use of stilling wells, refer to Section VI, Section 93, of the *Water Measurement Manual*, published by the United States Department of the Interior, Bureau of Reclamation (1967). Not all stilling wells are suitable for bubble line installation. If the well is subject to silting or buildup of foreign material, you should probably avoid it and mount the bubble line in the flow stream proper.

3.5.10 Flume Bubble Line Fittings

The large variety of primary measuring devices and installations makes comprehensive bubble line installation instructions impractical. However, valid general observations on bubble line installation can be made. Flumes can be specified to include a bubbler fitting. In new construction, this is highly recommended. It may even be possible to modify an existing installation to include a permanent bubbler fitting.

3.5.11 Bubble Line Extensions

For some applications, metallic bubble line extensions may be helpful. Teledyne Isco offers both stainless steel and copper bubble line extensions. The stainless steel tube may be easier to install in the flow stream than the plastic bubble line because of its relative rigidity. Two different extensions are available to match the two standard bubble lines.

The extension for the Teflon bubble line includes a silicone rubber tubing connector, and the tubing installation is as described above. The vinyl bubble line attaches by simply slipping the vinyl tube over the end of the extension. Some people have found that the use of a copper extension to the bubble line is advantageous in applications where algae tends to grow in the bubble line.

The copper salts released by the tubing are algicidal agents that tend to inhibit the growth of algae. However, the copper tubing may not be compatible with the flow stream, so use it with caution. Attach the copper bubble line extensions to the bubble line in the same way as the stainless steel extensions.

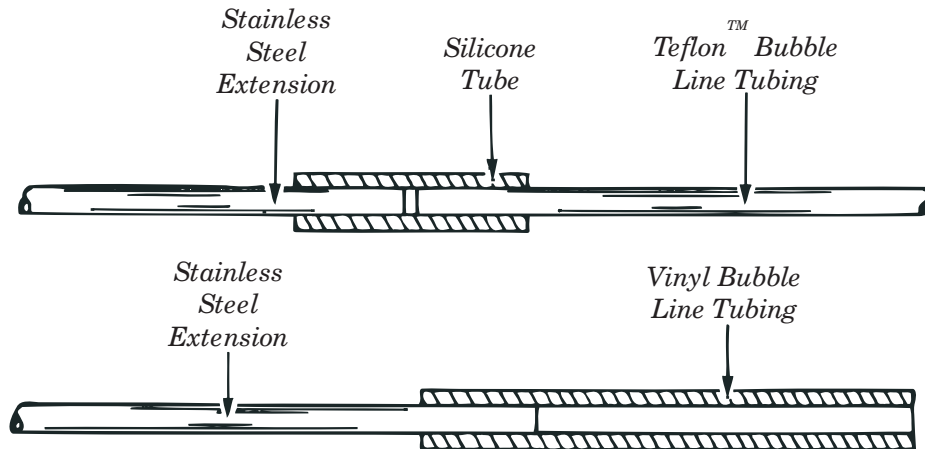

Figure 3-5 Installing the Stainless Steel Bubble Line Extension

3.5.12 Open Channel Installation

If you do not use a stilling well, attach the bubble line to the side of the flow channel or flume. Make the attachment so it causes a minimum amount of disturbance to the flow stream. If possible, cut a groove in the side of the channel, place the bubble line in the groove, and then grout over the groove.

Alternatively, you can attach the bubble line to the side of the channel, and then grout over the line to form smooth, sloped lead-in and lead-out surfaces. However, if neither of these methods is practical, you may simply attach the bubble line to the side of the channel or the upstream side of a weir using stainless steel and/or plastic mounting hardware.

In any case, always install the bubble line so it causes as little disturbance to the flow stream as possible. This usually means an installation on or adjacent to a channel wall where there is a condition of stagnant flow. For temporary survey applications, you can attach the bubble line with waterproof tape or other temporary means.

3.6 Flow Metering Inserts

Flow metering inserts are available for use with the 4230 Flow Meter that you can temporarily install inside **round pipe** sewers and flow streams to create a primary device inside the pipe. These inserts are available to fit 6", 8", 10", and 12" pipes and install from street level.

Teledyne Isco does not recommend using these inserts for permanent installation due to the likelihood of eventual clogging. For long-term operation, use of the Bubbler Tube Retainer Assembly, with an appropriate Isco Mounting Ring, is a preferable alternative to the Flow Metering Inserts, as there is

no restriction to flow. Moreover, with the Universal Mounting Ring, pipe sizes of as much as 72" in diameter can be accommodated.

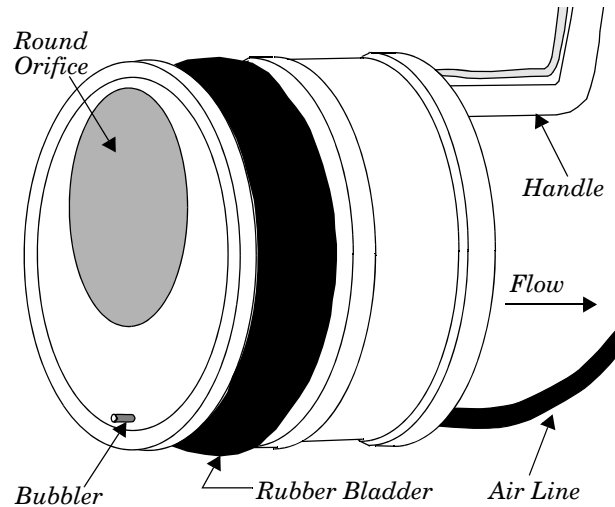

Figure 3-6 Flow Metering Insert

The insert consists of a metal collar surrounded by an inflatable rubber bladder. A removable metal plate, formed with a V-notch opening, attaches to the upstream side of the insert. Each insert also contains a bubble line for a 4230. The rubber bladder, inflated by a removable, foot-powered pump, holds the insert securely in place after you install it inside the pipe.

The metal plate, attached to the insert, forms a V-notch weir inside the pipe. If you remove this V-notch plate from the insert, an off-center round opening appears in the insert. This opening is 60% of the nominal pipe size. If flow in the pipe exceeds $\frac{1}{4}$ to $\frac{1}{3}$ of full capacity, Teledyne Isco recommends you use the round orifice rather than the V-notch plate.

CAUTION

The flow metering inserts create a restriction in the flow stream and a corresponding head loss. Use them with care in flow streams with suspended solids, or high grease content, such as sanitary sewers.

The inserts may cause clogging, requiring maintenance. Where this is could be a problem, we suggest using the Bubbler Tube Retainer with an Isco Mounting Ring instead.

The inserts are anodized aluminum and are corrosion-resistant. However, you should avoid using them in flows with agents capable of attacking either the aluminum (strong alkalis) or the rubber bladder (certain organic solvents).

3.7 The Bubbler Tube Retainer Assembly

For situations where the Flow Metering Inserts are not an ideal solution, Teledyne Isco offers the Bubbler Tube Retainer Assembly for installation inside round pipe. This system uses a bubbler tube attached to a snap-on probe carrier similar to those used for the other probes (see Section 4).

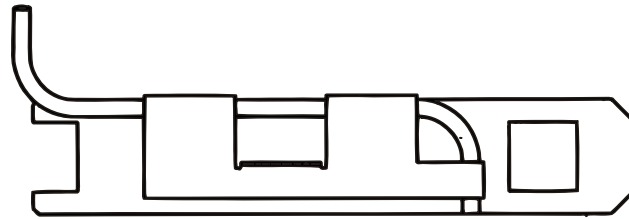

Figure 3-7 Bubbler Tube Retainer Assembly

The carrier snaps onto the mounting tabs of a stainless steel ring. The ring itself fits inside the pipe. Teledyne Isco offers two systems: one that attaches to an Isco Mounting Ring for pipes with diameters 15 inches or less. For pipe sizes from 18" to 72" in diameter, Teledyne Isco offers the Universal Mounting Ring. These rings are designed to accommodate various Isco submerged probes, all installed with the same easy snap-on carriers. Detailed information on the installation of probes, etc. on rings inside round pipes is provided at the end of Section 4.

3.8 Connection to a Sampler

The following sections describe connecting the 4230 to Teledyne Isco and non-Isco samplers.

One of the uses of the 4230 Flow Meter is to control a sampler in a flow-paced sampling mode. Flow-paced sampling means that the flow meter signals the sampler to take a sample after a certain volume of flow has passed through the flow stream, rather than after a particular period of time. In this mode, the sampler and flow meter are able to compensate for varying flow rates.

You can use the 4230 Flow Meter with most Isco samplers and with most other manufacturers' samplers as well.

An optional 25-foot (7.6 m) long connect cable is available to connect the flow meter to the sampler. Attach the 6-pin female connector on the cable to the Sampler connector on the side of the flow meter. (This is the second connector from the top.) Attach the connector on the other end of the cable to the Flow Meter connector on the sampler. This also connects the flow meter to the

sampler's power supply, and the sampler will be able to receive flow-proportional signals from the flow meter. Refer to the sampler manual for further details.

 **Note**

The flow meter-to-sampler connect cable has been changed. It now has six wires. You must use the new cable if you want to take advantage of the programming "sampler enabling" feature. Earlier cables will not allow this feature to work. Pin "F" is not connected; you can verify this pin with an ohmmeter or continuity checker. A "new" cable will show continuity (zero ohms) between the two "F" pins; an old" cable will show open.

**3.8.1 Connection to Other
Isco Equipment**

Teledyne Isco manufactures a variety of useful accessories for use with the 4230 Flow Meter. Among these options are: modems, parameter sensors, the alarm relay box, the rain gauge, a 4-20 mA output device, software, and a mechanical totalizer.

These and other options, along with details about their use, are all described in Section 4.

4230 Flow Meter

Section 4 Optional Equipment

This section describes accessories and companion equipment available for use with the 4230 flow meter. There are two groups of equipment. One group can be used with any 4200 series flow meter. The other group is equipment for a specific type of level sensing and can only be used with the 4230 flow meter. This section covers the accessories usable with any 4200 series flow meter. Application-specific options are covered in the Installation sections of each type of flow meter.

Teledyne Isco offers the following options for use with all 4200 series flow meters:

- 4200T Modem
- Internal and external 4-20 mA (Analog) Outputs
- 674 Tipping Bucket Rain Gauge
- Flowlink® Software (used with the modem or a laptop computer)
- Parameter Probes - Temperature, pH (acidity/alkalinity) and D.O. (dissolved oxygen)
- Mechanical Totalizer
- High-Low Alarm Relay Box
- YSI 600 Multi-Parameter Sonde

The 4-20 mA Output Interface, alarm box, rain gauge, parameter probes are options you can **field-install** any time. The modems require **factory modification** to the flow meter, and you should specify these options when you order. If you want to add any of these later, you will need to return the flow meter to the factory.

4.1 4200T Modem

The 4200T Modem is a circuit board installed inside the flow meter that transmits flow meter data over standard telephone lines. The modem also makes it possible for the flow meter to receive data from compatible equipment at the other end of the phone line. Modems allow digital equipment to talk and listen to other remotely-located digital equipment over telephone lines.

4.1.1 How it Works

The analog phone system cannot transmit digital signals through repeaters; digital machines cannot communicate directly over phone lines. Modems convert the data into tones and transmit them over phone lines. The equipment on the other end of the line answers with tones through its modem. The first modem converts these tones back to digital data and interprets it. The 4200T Modem is full duplex and works in the auto-answer

mode. It operates at 300/1200/2400 baud. This modem has speech and tone capabilities and comes with a connect cable to attach to the telephone line.

 **Note**

The modem is disabled when an interrogator cable is connected to the flow meter's interrogator port. It cannot receive incoming calls, and the alarm dialout will be rendered inoperable, while this cable is connected. **Disconnect the interrogator cable in order to use the 4200T Modem.**

4.1.2 Modem and Flowlink Software

The 4200T Modem communicates with Teledyne Isco's Flowlink data storage and acquisition software, setting up the flow meter to collect blocks of data. Flowlink allows storage and interpretation of flow meter data. Other Flowlink software packages can write reports with this collected data.

4.1.3 Connection to a Line

The FCC (Federal Communications Commission) governs communications over telephone lines. Your local telephone company will provide you with the line between the flow meter and the computer. Call them for connection information. The FCC requires the following information be published for connecting the modem to the phone line.

 **Note**

"This equipment complies with part 68 of the FCC rules. On the case of this equipment is a label that contains, among other information, the FCC registration number and ringer equivalence number for this equipment. If requested, this information must be provided to the telephone company."

"This equipment uses the following USOC jacks: USOC RJ11C.

"The REN is used to determine the quantity of devices that may be connected to the telephone line. Excessive REN's on the telephone line may result in the devices not ringing in response to an incoming call. In most, but not all areas, the sum of REN's should not exceed five (5.0). To be certain of the number of devices that may be connected to the line, as determined by the total REN's, contact the telephone company to determine the maximum REN for the calling area.

"If this equipment causes harm to the telephone network, the telephone company will notify you in advance that temporary discontinuance of service may be required. If advance notice isn't practical, the telephone company will notify the customer as soon as possible. Also, you will be advised of your right to file a complaint with the FCC if you believe it is necessary.

"The telephone company may make changes in its facilities, equipment, operations, or procedures that could affect the operation of the equipment. If this happens, the telephone company will provide advance notice in order

for you to make the necessary modifications in order to maintain uninterrupted service.

“If trouble is experienced with this equipment, please contact the Teledyne Isco Customer Service Department, (800) 228-4373 or, outside the U.S.A., call (402) 464-0231, 4700 Superior St., Lincoln Nebraska, 68504-1398, for repair and (or) warranty information. If the trouble is causing harm to the telephone network, the telephone company may request you remove the equipment from the network until the problem is resolved.

“The following repairs can be done by the customer:
None.

“This equipment cannot be used on telephone company-provided coin service. Connection to Party Line Service is subject to state tariffs.

“When programming and/or making test calls to emergency numbers:

“Remain on the line and briefly explain to the dispatcher the reason for making the call.”

“Perform such activities in the off-peak hours, such as the early morning or late evenings.”

4.1.4 Types of Service

The 4200T Modem is compatible with standard telephone lines and comes with a 12 foot cable. The cable connects the flow meter's Modem connector to a standard telephone jack, type USOC RJ11C, supplied by the phone company. You must mount the flow meter within 12 feet of this jack.

We are required by the FCC to provide the following notice:

 Note

“This equipment generates and uses radio frequency energy and if not installed and used properly, in strict accordance with the manufacturer's directions, may cause interference with radio and television reception. There is no guarantee that interference will not occur in a particular installation. If this equipment does cause interference to radio or television reception, which can be determined by turning equipment off and on, the user is encouraged to try to correct the interference by one or more of the following measures.”

- Reorient the receiving antenna on the television.
- Relocate the unit with respect to the receiver.
- Plug the unit into a different outlet so the unit and receiver are on different branch circuits.
- If necessary, consult the manufacturer or an experienced radio-television technician for additional suggestions.

You may find the following booklet, prepared by the FCC, helpful: *How to Identify and Resolve Radio-TV Interference Problems*. This book is available from the U.S. Government Printing Office, Washington, D.C. 20402, Stock No. 004-00-00345-4.

4.2 Connections to External Serial Device

Teledyne Isco offers two serial outputs from 4200 series flow meters. There is a software-enabled output that is transmitted on the RAIN GAUGE connector. This signal also appears on the INTERROGATOR connector. This feature lets the flow meter transmit the most recent values for all currently enabled ports as ASCII text. You can select the baud rate and the frequency of transmission. You can then write a simple program to retrieve this data periodically, or you can do it interactively using a terminal program. This option (SERIAL OUTPUT) is discussed in detail in Section 2.7.2.

Teledyne Isco still offers the older 300 baud output for the Model 2312 Plotter (no longer sold) also on the RAIN GAUGE connector. This port provides ASCII level and flow rate data for remote transmission to any ASCII-compatible equipment. Every 15 seconds the flow meter transmits a line of data which includes level, units of level measurement, percentage of maximum flow rate, maximum flow rate, a total flow value, units of flow, sample number, bottle number, text, time, and date.

If you are using the flow meter with an Isco sampler, the data line also includes an indication of a sampling event.

You can transmit this data line to a computer, or to a locally-connected (within 250 feet) device capable of interpreting serial data, such as a video display terminal or a printer. The specifications for this serial data output are as follows: 300 baud, 7 data bits, 2 stop bits, even parity. The printed (or displayed) line contains 110 characters and will appear similar to the following:

```
+01.409F 100.00% 2.500+0 CFS    0001533+0 CF    00 00 90  
DEGREE V-NOTCH WEIR  
000 0 90 04 04 02 31 48
```

The last two characters (not displayed) are a `CR' (carriage return) and a `LF' (line feed). The large gaps between some of the words indicate extra character spaces which are not used in this particular text, but which are available for use if needed.

Note

1. You cannot use both serial outputs at the same time. You must select one or the other.
2. The serial output is paralleled with the Interrogator Port and the Internal Modem. Use of either the Interrogator Port or the Internal Modem will cause non-standard data to be transmitted.

4.3 4 to 20 mA (Analog) Outputs

These outputs provide connection between a 4230 Flow Meter and non-Isco process-control equipment, such as chlorinators, or any other type of equipment that you can control with a 4-20 milliampere current loop. Analog outputs convert digital information from the flow meter to a variable analog output current ranging from 4 to 20 milliamperes. When a condition measured by the flow meter is converted into an analog output, 4 mA becomes the 0% or baseline for the condition, while 20 mA becomes the 100% or full-scale of the condition. Teledyne Isco offers two different arrangements for providing the 4-20 mA outputs. One is an external box that converts the signals from the flow meter to a 4-20 mA current loop. The other is an internal circuit board containing three separate analog output circuits on the same board.

The 4 to 20 mA current is an industrial standard current loop for process control equipment that must respond to changing conditions by varying output rates.

4.3.1 External 4-20 mA Output Interface

The external **4-20 mA Output Interface** has its own case and AC power supply. Commercial power (120 VAC) must be available for this device. Battery operation (12 VDC) is not feasible due to voltage and current demands. It comes with a line cord, connectors, and two interconnect cables. One cable has 6-pin M/S connectors on both ends. This cable connects the input of the 4-20 mA Output Interface to the flow meter Interrogator connector. The other cable has a three-pin plug on it that connects to the output connector of the 4-20 mA Output Interface. This cable ends in three pigtailed wires you connect to the equipment you want to control with the 4-20 mA Output Interface.

**Table 4-1 4-20 mA Output Interface:
Technical Specifications**

Power	120 VAC ¹ / ₈ Amp.
Output Connector	3-pin male plug Pin A: + current out Pin B: – current out Pin C: not used
Output Accuracy At 72° F (22°C) Full Oper. Range	±0.25% of full-scale ±0.5% of full scale
Operating Range	0° to 140°F (–18° to 60°C)
Resolution	0.1% of full-scale

Table 4-1 4-20 mA Output Interface: Technical Specifications (Continued)	
Input Connector	6-pin male M/S Pin B: – pulse input Pin F: + pulse input Pins A, C, D, E: NC
Isolation	Output current optically isolated from flow meter.
Fusing	$\frac{1}{4}$ Amp. internal on AC line.
Adjustments/ Calibration	Factory-calibrated; when used within range, no adjustment needed,
Maximum Distance	1,500 ft. (457.3 m) using 18 AWG wire.



Figure 4-1 4-20 mA Output Interface

4.3.2 Internal Analog Output Board

For those needing more than one analog output, Teledyne Isco offers the **Multiple Analog Output Board**, which is installed inside the flow meter. This board provides three isolated analog outputs. The board is compatible with the existing external 4-20 mA output box (60-1784-039). A flow meter can use either the internal board, the external box, or both, for a maximum number of four analog outputs.

✓ Note

If your flow meter has both the multiple analog output board and the external analog converter, the internal ports will be designated Analog Outputs 1, 2, and 3. The external converter will be designated either “External” or “Analog Output 0.”

The Multiple Analog Output Board consumes a minimum of 16 mA per output; consequently, the flow meter should be AC-powered. If you must use battery power, you should consider the following to extend battery life:

- Use a Solar Panel Battery Charger
- Use a larger battery: either a commercial deep-cycle/marine type, or an Isco 35 Ampere-hour lead-acid battery.
- Order and use only one analog output.
- Flow meter program choices also affect power consumption. Use “minimum” settings, if possible. (See Section 1 Table 1-5 and Section 5.)

The outputs from the analog output board are electrically isolated from the flow meter and from each other by internal DC-DC converters. The board uses the opening for the modem connector for its outputs. Normally, a flow meter will not need both the analog and modem boards. If your installation does, however, you should contact the factory.

The analog board terminates in a 6-pin male M/S connector on the flow meter case. Flow meters built with the analog board option are also supplied with an output cable. This cable connects to the wiring that runs to the equipment controlled by the 4-20 mA current loop and to the 6-pin M/S connector on the flow meter. The cable has a 6-pin female M/S connector and is provided with stripped pigtail ends for convenient wiring.

Table 4-2 Multiple Analog Output Board: Technical Specifications (each circuit)

Temperature (operating)	0 to 140° F (–18 to 60° C)
Output Accuracy	±0.5% of full-scale
Resolution	0.1% of full-scale (0-20 mA)
Electrical Isolation	Isolated from each other and from the flow meter.
Calibration	Factory-calibrated; no further adjustments necessary.
Maximum output distance	1500 feet (457.3 m) using 18 AWG wire.
Current Range (per loop)	0 to 20 mA
Maximum Load (per loop)	750 ohms

Table 4-2 Multiple Analog Output Board: Technical Specifications (each circuit) (Continued)	
Analog Output 1 Terminations	Pin A (Red wire -) Pin C (White wire +)
Analog Output 2 Terminations	Pin D (Brown wire -) Pin F (Blue wire +)
Analog Output 3 Terminations	Pin E (Black wire -) Pin B (Green wire +)
Note: If you must strip the cable further back to facilitate wiring, you will expose an orange, yellow, and purple wire. You may disregard these wires, as they are not connected in this application.	

4.4 Tipping Bucket Rain Gauge

A Tipping Bucket Rain Gauge is available from Teledyne Isco for use with 4200 Series Flow Meters. The rain gauge connects to the flow meter by a cable terminated in an M/S connector. This connector plugs into the Rain Gauge connector on the case. A Y-connect cable is available that allows use of both the rain gauge and a YSI 600 Multi-Parameter Sonde at the same time. You can connect extra cable (user-supplied) between the rain gauge and the factory-supplied cable as long as you do not exceed a maximum total length of 1,000 feet. Use 18 AWG wire or larger. Do not cut the M/S connector from the cable. The rain gauge is factory-calibrated to provide a contact closure to the flow meter for every hundredth of an inch (0.01") [or 0.1 mm] of rainfall. Software in the flow meter stores this information in memory and prints the accumulated data as a text line on the printer chart. It also allows the printout to be expressed in metric. You may, if you wish, provide a rain gauge of your own choice, but to ensure compatibility with the flow meter's operating environment, it must conform to the following specifications:

- It must provide an isolated, dry contact closure.
- It must be a normally open contact configuration.
- It must close for 100 ms (-25 ms +150 ms) with less than 2 ms contact bounce.
- It must provide a contact closure for every 0.01" (or 0.1 mm) of rainfall

A cable assembly is available to connect a user-supplied rain gauge to the flow meter. Further information about the rain gauge is available from the factory or its manual.



Figure 4-2 674 Tipping Bucket Rain Gauge

4.5 Isco Flowlink Software

Teledyne Isco offers a proprietary software system for data acquisition, storage, retrieval, and analysis. This software system, Flowlink, contains programs that allow 4200 series flow meters to store blocks of level and other data readings in the flow meter's memory. You retrieve this stored data with either a laptop computer or central computer connected to the flow meter by modem. You can use other programs in the package to process the retrieved data for further analysis. In addition to storing data, this software makes it possible to divide part of the flow meter's memory into partitions. These partitions may be formatted in "rollover" or "slate" mode of data storage. You can also set up the flow meter to store data as a result of some sort of "triggering" event, such as level rising to a predetermined point, the passage of a predetermined time interval, or the occurrence of a storm event, such as rainfall.

Consult the factory. A detailed explanation of the Flowlink Software is beyond the scope of this manual. Information on Flowlink Software is available from its manual or from the factory.

4.6 High-Low Alarm Relay Box

Teledyne Isco offers a control box that monitors flow rate data available from any 3000 or 4200 Series Flow Meter. Alarm relays trip when the flow rate exceeds or falls below pre-selected limits. High and low set points are user-set and range from 0% to 99% in 1% increments. Output from the unit is the switching of form C (SPDT) relay contacts. The unit has 2 relays; one for high alarm and the other for low. The availability of form C contacts (both

NO [normally open] and NC [normally closed] contacts) means you can switch loads either on or off. Relay contacts are rated 3 Amperes at 24 volts AC or DC. The alarm box operates on 12 VDC supplied from the flow meter. Current consumption in standby condition is approximately 10 mA. In alarm, current increases to 190 mA. You can connect as many as four alarm boxes to a flow meter, if the flow meter is powered from the AC line.

 **Note**

1. Do not use the alarm box if your flow meter has a modem or uses Flowlink software (through either a modem or laptop computer).
2. Use the alarm box with caution in battery-powered installations, as it will significantly increase power consumption.

In standby condition, an alarm box consumes about one ampere-hour of battery capacity in four days (or reduces capacity approximately 25%). In alarm condition, one alarm box will completely discharge a fresh (4 Ah) battery in 21 hours. Teledyne Isco recommends using only one alarm box in a battery-powered installation, and you can expect to change the battery more often.

4.6.1 Installation

The High-Low Alarm Relay Box is enclosed in a high-strength plastic box. Mount the unit with corrosion-resistant hardware through the two holes in the stainless steel mounting plate attached to the case. Two threaded holes in the case allow the use of either 1/2" conduit fittings or compression bushings. While the alarm box is suitable for use in damp locations, do not install it where there is any possibility of submersion. Where temperatures are expected to fall below freezing, Teledyne Isco recommends installation of the alarm box indoors or in a heated location, as the manufacturer of the microprocessor does not specify its operation below 32° F (0° C).

 **WARNING**

Hazard of electric shock! Use the relay contacts for low voltage (24 V) pilot duty only. Do not wire 120 VAC or higher voltages to the relay contacts.

4.6.2 Wiring to a 4200 Series Flow Meter

Connecting the High-Low Alarm Relay Box to a 4200 Series Flow Meter requires a cable and an M/S connector. A special cable, 25 feet long, is available from Teledyne Isco. On one end of the cable is a 4-pin, male M/S connector. Plug this connector into the Rain Gauge connector on the flow meter. The other end of the cable has three stripped wires. Attach them to the alarm box according to the instructions in the alarm box manual.

BLACK	+12 VDC
GREEN	-12 VDC
WHITE	DATA

4.7 Parameter Sensing

All Isco 4200 Series Flow Meters have the capability of displaying, recording, and (if Flowlink software is used) storing data provided from parameter sensors. The parameter sensors that are available from Teledyne Isco for use with 4200 Series Flow Meters are for temperature measurement, dissolved oxygen (D.O.) and pH (indicating the acidity or alkalinity of a solution), and the YSI 600 Multi-Parameter Sonde. See Section 4.11 for information on the YSI 600 Sonde. This section covers the Isco pH, D.O., and temperature sensors.

4.7.1 Installation of Parameter Probes

All three parameter probes, as well as other Isco probes such as the submerged probe level sensor and area-velocity probe, require complete submersion in the flow stream for proper operation. Dry operation can damage the pH and D.O. probes. The YSI Sonde (only) may be suspended vertically in the stream. Teledyne Isco offers a series of rings that provide mounting for all probes in round pipes.

- Each probe snap-mounts to a specialized sensor carrier.
- The sensor carrier then attaches to the rings or mounting straps.
- The probe cable is carefully routed out of the stream.
- Only the temperature probe can connect directly to the flow meter's parameter probe connector.
- The pH and D.O. probes both connect to parameter modules (amplifiers). The pH probe connects to the 201 pH Module and the D.O. probe connects to the 270 D.O. Module. **The modules are not interchangeable.**

 **Note**

The 270 D.O. module has been discontinued. Probes, service kits, and accessories are still available to maintain existing field units.

Isco flow meters are built with *one* parameter sensing port. You must select temperature, D.O. with temperature, or pH with temperature. If you want to change probes later, you can, but you will need to change certain aspects of the flow meter's program. Selection of either pH or D.O. in **step 1** of the program (where units of measure are defined) will lock out any mention of the other probe in the menus for the rest of the program.

The Parameter Modules themselves plug into the Parameter Probe connector on the flow meter.

Note

The pH and D.O. probes require continuous submersion after installation, or they will lose sensitivity. **Prolonged dehydration of the sensor bulb may damage or even ruin the pH probe.**

4.7.2 Temperature Probe

The temperature probe is the simplest of the three, consisting of a thermistor inside a metal housing. The thermistor changes resistance with an increase or decrease in temperature. The flow meter converts this resistance change to a temperature reading and displays it, in degrees Celsius or Fahrenheit, as chosen by menu selection during programming.

4.8 pH Probe

The pH probe measures the acidity or alkalinity of an aqueous solution by determining the relative quantity of dissociated hydrogen ions, H^+ (actually H_3O^+) in the solution. A larger quantity of H^+ ions indicates acidity, while a smaller quantity of H^+ ions indicates alkalinity. The H in pH stands for Hydrogen and the p stands for power.

The normal scale for pH runs from 0 to 14, with 0 being most acidic and 14 being most alkaline. Distilled water at 25° C is neutral at 7, based on the fact that the dissociation constant (number of H^+ and OH^- [hydroxyl] ions present) for pure water at that temperature is 10^{-7} .

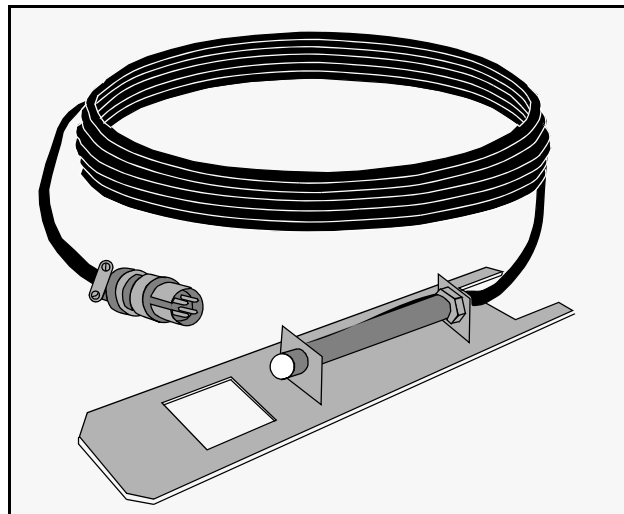

Figure 4-3 Temperature Probe

A dissociation constant is a number that indicates the amount of ionic dissociation occurring for a given substance after it is dissolved in aqueous solution. Dissociation constants vary widely for substances depending on the nature of the chemical bonds within the substance.



Figure 4-4 pH Probe With Protective Cap

Each number on the pH scale between 7 and 0 equals a tenfold increase in H^+ ion. Each number between 7 and 14 equals a tenfold decrease of H^+ ion. pH measurements of wastewater are commonly made to monitor the effect of treatment chemicals added to raise or lower the pH.

Water that has been used for various industrial processes may deviate substantially from 7. Chemicals are often added to the water to bring the pH close to that of neutral water, which is 7.

For example, if the effluent has a concentration of heavy metal ions, they must be removed before discharge. Raising the pH of solutions containing transition-metal ions will cause them to precipitate, where they can easily be removed as sludge. The resultant solution will be high in pH and will require acid to neutralize it.

4.8.1 How the pH Probe Works

The pH probe is a combination of two electrochemical half-cells. Together they provide a low-voltage signal that corresponds to the hydrogen-ion concentration of a solution. If you look at the pH probe, you will see a glass bulb on one end. This is called the glass mono electrode. The glass is of special composition and sensitive only to hydrogen ions. It is exposed to the solution to be measured. The specific sensitivity to hydrogen ions prevents interference from other ions that may be present in the solution. The glass membrane produces an electrical potential proportional to hydrogen ion activity.

The other electrode, called the reference electrode, completes the circuit between the glass electrode and the solution.

The Isco pH probe combines both electrodes in a single housing and also contains an amplifier to reduce the extremely high impedance of the circuit. This improves the reaction of the probe to stray capacitance and reduces interference caused by electrical noise in the vicinity. pH measurement is affected significantly by temperature, like any other chemical reaction. Consequently, temperature compensation is provided in the flow meter. The Isco pH probe has a built-in temperature sensor that is exposed for faster response.

The pH probe connects to a 201 module that plugs into the Parameter Port on the flow meter. The probe has a 25 ft. (7.6 m) cable. For greater distances, contact the factory. The maximum distance between the module and the flow meter is 1,000 ft. (304.8 m).

 **Note**

Do not connect a Isco pH probe and temperature probe to the 201 module at the same time. The “Temperature Probe” input on the 201 module is for use ONLY with non-Isco pH probes that do not have built-in temperature sensing. The Isco pH probe contains its own integral temperature sensor, which, if connected in parallel with a separate temperature probe, will cause erroneous readings.

When the ion-selective electrode and the reference electrode are connected to a high-impedance voltmeter and submerged in solution, ions move to the surface of the membrane. The electrical charge on the ions creates a potential difference across the barrier between the solution and the membrane. This potential, or voltage difference, is proportional to the activity of the ions in solution.

The potential, when read by a sensitive voltmeter, translates into a reading of pH. With an Isco flow meter, the voltage is sent first to a preamplifier inside the probe to reduce the impedance of the circuit and improve the signal-to-noise ratio, and then on to the 201 module to allow greater operating distance from the flow meter. The flow meter determines the pH value and displays it.

4.8.2 pH Probe Calibration

The 4230 provides a two- or three-point calibration for the pH probes with commercially-prepared calibrated buffer solutions. Calibrations of 4 and 7, 7 and 10 and 4, 7, and 10 are all possible. For accurate readings you must clean and re-calibrate the probe on a regular basis. How often you need to do this depends on the condition of your flow stream.

Flow streams with a high grease content will coat the sensing surfaces of the probe quickly, clogging them and slowing the response time or stopping it altogether. **Installation in very greasy flow streams is not recommended.**

 **Note**

For pH probe calibration, Teledyne Isco recommends that you use a glass container for the buffer solutions to ensure that the following conditions are met:

The probe must be properly submerged in solution, and there must be no air trapped under the probe membrane, or the reading may become incorrect and/or erratic.

Do not touch the probe until after you have performed step 6.

1. To calibrate the pH probe with the flow meter, first go to program Step 1 PROGRAM, SETUP and select PROGRAM.

2. Step through the units of measure with the **Enter** key until you reach the menu that says pH UNITS - NOT MEASURED, pH. Select pH. You must do this in step 1 or the pH menu will not appear later.
3. Now go to step 3. PARAMETER TO ADJUST - NONE, LEVEL, pH. (Other selections may appear.) Select pH. If the pH menu does not appear in step 3, go back to step 1 to make sure you have turned it on. Then the pH selection of calibrations will appear.
4. Place the pH probe in the appropriate buffer solution until the stainless steel body is one inch beneath the surface.
5. If you select 4 & 7, the following will appear. Calibration with the other menu options (7 & 10 or 4, 7, & 10) is essentially the same as shown below. For the other menus, see Section 2.

RINSE PROBE AND PLACE IN 4.0 pH SOLUTION
PRESS ENTER WHEN STABLE: X.XX pH

6. Wait for the reading to stabilize (this may take from 30 seconds up to 5 minutes). When the probe has stabilized, press **Enter** and the following display will appear:

RINSE PROBE AND PLACE IN 7.0 pH SOLUTION
PRESS ENTER WHEN STABLE: X.XX pH

When you have entered this second value, the pH probe calibration is complete. You can then install the probe in the flow stream.

Note

An asterisk (*) may occasionally appear next to the pH reading for approximately 30 seconds, during which time the most recent reading will be displayed. This may be normal flow meter operation due to other internal functions, or could indicate pH fluctuation in the stream.

4.8.3 pH Probe Installation Guidelines

Installation of the pH probe is similar to the submerged level sensor, other parameter probes, and the area-velocity sensor.

- Install the probe only in streams that have continuous flow. The sensing end of the probe must *always* remain wet.
- For proper operation, there must also be enough flow to submerge the sensing end of the probe completely.

If flow in the stream is intermittent (dry for periods of time), the pH sensing bulb will dry out and its response time will slow. This is a problem in situations where pH changes rapidly. If the probe is dry long enough, it will first lose sensitivity, then be slow to respond, and finally be ruined. **Never let the sensing end of the probe dry out completely.**

- Installation in streams with high grease content will result in poor performance and require frequent cleaning and recalibration. Greasy substances, being nonconductors of electricity, weaken the electrical potentials formed between the glass mono-electrode and the solution, slowing or halting the response altogether.
- The pH Sensor operates satisfactorily mounted either horizontally or vertically in the stream. However—
 - Horizontal mounting is more secure, and presents less of an barrier to trap debris.
 - Simple suspension of the probe is not recommended, particularly in streams of high velocity, or those that carry debris.

If you mount the pH probe vertically, mount it securely. Do not just hang it from the top of the pipe by its cable. Suspending the probe in the stream is not stable.

For horizontal mounting, the probe fastens to a sensor carrier that snap-fits to an Isco mounting ring. The mounting rings fit various diameters of round pipes 15" diameter and smaller. For larger pipes, use the Isco Universal Mounting Ring. For installation details, refer to the instruction sheet supplied with the mounting ring.

The mounting rings are held in place by the outward force of spring pressure in the smaller sizes and by a screw arrangement in the larger sizes. After mounting the probe in the ring or strap, route the cable out of the stream so it will not trap debris that could clog the sewer.

Mount the pH Module within 25 feet of the probe, but in a location higher than the highest anticipated level for the flow stream. The amplifier box is sealed and will withstand temporary submersion, but this should be avoided.



Figure 4-5 201 pH Module

Note

When installing the pH probe and its sensor carrier, make sure the mounting slots on the carrier are completely pressed into the mating tabs on the ring. The probe relies on a full engagement between tabs and slots for secure mounting. If the slots are loose against the tabs, the probe may be swept away by the force of the stream.

- Always mount the probe in an easily-accessible location, because you will need to service it (cleaning) from time to time.
Also, you will eventually need to replace it. You can mount the probe facing either upstream or downstream, but Teledyne Isco recommends facing upstream, as there is a stop on the sensor carrier that is not effective when the probe is facing downstream.
- Remember to unscrew the rubber guard cap from the sensing end of the probe when you install it, or the probe will be unable to sense the flow stream.
The guard cap is to protect the probe during shipment and storage and to keep the glass membrane and liquid junction from drying out. If you remove the probe for any reason, clean it and replace the cap after filling with 4.0 buffer solution. **Never store the probe dry or without the cap in place.**

The Isco amplifier box extends the allowable distance between the probe and the flow meter. The probe has a 25-foot cable, so you must mount the amplifier within this distance. The maximum distance between the amplifier box and the flow meter is 1,000 feet.

Table 4-3 pH Probe Technical Specifications

Description: Submersible, horizontal-mounting probe with combination-type electrodes. Porous Teflon [®] liquid junction to resist fouling and coating. Steam-sterilized glass hemi-bulb for long-term stability.	
Size	6" long × 3/4 NPT.
Body Material	Stainless Steel
pH Range	0 to 14 pH units.
Temperature	32° to 176° F (0° to 80° C).
pH Accuracy	±0.1 pH units over the full range.
pH Electrode Junctions	Type II Double porous junction
Temperature Compensation: Done by software inside the flow meter. The pH Probe contains an integral temperature sensor.	

All pH probes are consumable items, meaning that they will eventually fail and have to be replaced.

During the life of the probe, you will have to clean and recalibrate it periodically. Grease and debris will interfere with the probe's ability to measure pH accurately. Grease, particularly, will coat the end of the probe. Because grease is an insulator, it will keep the ions from reaching the glass membrane and porous liquid junction, thus failing to create a voltage potential.

You can consider the pH probe at its end-of-life when you can no longer calibrate it (after cleaning) to ±0.2 pH with the standard buffers of 4, 7, and/or 10. Another indication of end-of-life is when the probe calibrates satisfactorily, but takes too long to stabilize (more than 10 minutes). Such a probe could not possibly respond to rapidly-changing pH. If your situation requires fast response, you might consider end-of-life to be when stabilization time reaches five minutes.

4.8.4 Storage and Maintenance of pH Probes

If you remove the pH probe from operation, be careful to keep the glass sensor bulb wet. Always store the probe with the rubber cover screwed completely over the threaded end of the sensor. Exposure to air causes the glass membrane on the sensor bulb to dry out. This makes it very slow to respond in solution. Prolonged or repeated dehydration of the bulb may ruin the probe.

The pH sensitive glass can become “conditioned” to its environment, especially when it is continuously exposed to high pH (10 and above) solutions. The glass does have a memory and will respond slowly when exposed to a lower pH solution after having been in a high pH solution for any significant period of time.

Storage of a pH probe in a 4.0 buffer solution is recommended as this has a regenerative effect on the glass and does not put a memory on it. Tap water will work if 4.0 buffer solution is not available. Deionized water is good for quick rinses to clean the element, but not for prolonged storage of an electrode. Continuous exposure of the ion-sensitive membrane to a wetted, but deionized water solution will improperly condition the membrane.

The reference electrode is also adversely affected when allowed to dry out. Salt crystals from the electrolyte or precipitates of the solution measured will form salt bridges either within or on the surfaces of the liquid junction, causing the reference to be less conductive and resulting in a higher reference impedance.

This condition will typically worsen until the unit no longer functions. Soaking the reference electrode in a 4.0 pH solution, or tap water if the buffer is not readily available, may bring the reference back to life. Boiling the electrode in 4.0 buffer solution or tap water could revive the electrode in more severe situations. If none of these works, it may be necessary to replace the probe.

4.9 The Dissolved Oxygen (D.O.) Probe

This probe measures the amount of oxygen dissolved in a stream or waterway. Oxygen dissolved in water is necessary for many forms of life that dwell in lakes and streams. Inadequate supplies of dissolved oxygen will cause fish and other aquatic life that depend on them as a food source to die off or be sharply diminished in numbers.

The measurement of dissolved oxygen content is of interest to those monitoring the condition of lakes and streams. Fish must have a certain minimum concentration of dissolved oxygen to thrive, typically 4 to 6 mg/l.

Various types of pollution can cause the amount of oxygen dissolved in water to drop sharply, placing the aquatic life forms at serious risk. The D.O. Probe measures the amount of oxygen dissolved in water in a range from 0 to 20 mg/l. Note that the flow meter can display D.O. in either mg/l (milligrams per liter) or ppm (parts per million) depending on your choice in programming.

 Note

The 270 D.O. module has been discontinued. Probes, service kits, and accessories are still available to maintain existing field units.

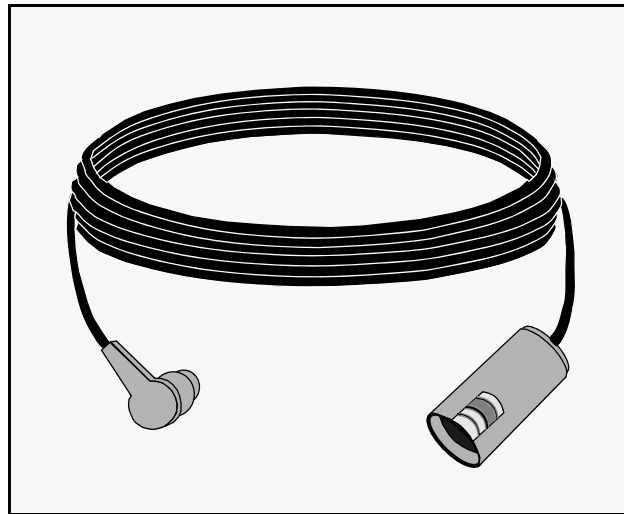

Figure 4-6 D.O. (Dissolved Oxygen) Probe

For successful use of the D.O. Probe, please read and consider the following:

- The D.O. Probe requires constantly moving water. The probe consumes oxygen during operation; this will deplete the oxygen available from stagnant or stratified waters, resulting in an inaccurate reading. Do not install it in a stilling well or in any location where water movement is intermittent or very low. As a guideline, a minimum velocity of **one foot per second** is suggested.
- Frequent maintenance is necessary when the probe is installed in flows with high grease or solids content. Tests conducted by Teledyne Isco with probes installed in various waste streams have indicated that greases and solids quickly coat the probe's membrane, making it impossible for oxygen to enter the reaction chamber. This will result in an abnormally low reading, or no reading at all. Cleaning the membrane is generally not effective, as it tends to drive the solids further into the pores. It is generally necessary to replace both the electrolyte and the diaphragm to get an accurate reading. In such severe cases of fouling it may be necessary to change the diaphragm very frequently, even as often as every other day.

4.9.1 How the D.O. Probe Works

A thin permeable membrane stretched over the sensor isolates the electrodes from the environment, but allows gases to enter.

When a polarizing voltage is applied across the sensor, oxygen that has passed through the membrane reacts at the cathode, causing a current to flow. The membrane passes oxygen at a rate proportional to the pressure difference across it. Since oxygen is rapidly consumed at the cathode, it can be assumed that the oxygen pressure inside the membrane is zero. Hence, the force causing the oxygen to diffuse through the membrane is propor-

tional to the absolute pressure of oxygen outside the membrane. As the oxygen partial pressure varies, both the oxygen diffusion through the membrane and the probe current change proportionally.

4.9.2 Probe Preparation

The following describes how to prepare a new probe for use, or how to change membranes on an existing probe. First, unscrew the sensor guard; remove the O-ring and membrane, then thoroughly rinse the sensor with distilled water. Prepare the KCl electrolyte according to the directions on the bottle. **Use distilled water only.** You install the membranes by hand. The probe is shipped with a small folder containing several replacement membranes. To install a new membrane, follow these steps:

1. Secure the probe body so it is in an upright position. You can use a vise, adjustable wrench, or locking pliers, etc., whatever is satisfactory. Do not apply too much force to the probe body, or you will crack it.
2. Fill the cavity around the silver anode with electrolyte. The liquid should be free of bubbles and should completely cover the tip of the sensor. Fill the cavity to the point where any more electrolyte would spill over.
3. Lightly lay the membrane across the top of the probe. If you do this carefully, there will be no bubbles under the membrane.

 Note

Handle the membrane material with care, touching it at the ends only.

4. Place the O-ring on top of the membrane, generally conforming to the circumference edge of the probe.
5. Place the thumb and index finger from both hands opposite each other on the O-ring at equal distances.
6. Roll the O-ring down over the end of the probe, being careful not to touch the membrane surface.
7. Trim off excess membrane with scissors or a sharp knife. Check to see that the stainless steel rod (thermistor) protruding below the liquid cup is not covered by extra membrane.

 Note

There must be no bubbles under the membrane and no creases in it for the probe to function correctly.

8. Shake any excess KCl solution from the probe. Reinstall the sensor guard. Keep the sensor in a humid environment when not in use and between measurements. The plastic bottle that was placed over the end of the sensor when it

was shipped is ideal for this purpose. Place a piece of moist tissue inside the bottle, and slide the bottle over the probe.

4.9.3 Membrane Thicknesses

Teledyne Isco supplies a 2 mil (.002") thick membrane for use with the D.O. probe. This membrane is recommended for long-term monitoring situations only, typical of our users' applications. Use *only* this thickness of membrane with D.O. probes connected to Isco flow meters. Do not use other thicknesses of membranes as the Parameter Module used with the probe is calibrated only for the 2-mil membrane, and cannot be recalibrated in the field. Use of other membrane thicknesses will result in inaccuracy.

4.9.4 Probe Installation

The D.O. probe attaches to a sensor carrier bracket that snaps into an Isco mounting ring. Use the specific size mounting ring for pipes less than 15" in diameter, and the Scissors Ring for pipe sizes greater than 15" diameter. Refer to the instruction sheet supplied with the mounting ring.

Note

When installing the D.O. probe and its sensor carrier bracket, make sure the mounting slots on the sensor carrier are **completely pressed** into the mating tabs on the ring. The probe relies on a full engagement between tabs and slots for secure mounting. If the slots are loose against the tabs, the probe may be swept away by the force of the stream.

4.9.5 Probe Operation and Precautions

The following factors determine the life of the D.O. probe and the frequency of service.

- Membrane life depends on use. Membranes will last longer if installed properly and treated with care during use. Contents of the flow stream are also important, as some substances will foul the membrane very quickly. Erratic readings will result from loose, wrinkled or fouled membranes, or from large bubbles in the electrolyte reservoir. If erratic readings or evidence of membrane damage occur, you should replace the membrane and the KCl electrolyte.
- In environments where the membrane becomes rapidly coated with oxygen-consuming or oxygen-evolving organisms, erroneous readings may occur. Chlorine, sulfur dioxide, nitric oxide, and nitrous oxide can affect readings by reacting like oxygen at the probe. If your readings seem unreasonable, you may need to perform analysis to determine whether these gases are the cause. Long-term use, as for monitoring, can magnify the effect of these factors in some applications.
- Avoid any environment containing substances that may attack any of the probe's materials. Some of these substances are concentrated acids, caustics, and strong solvents. The probe materials that come into contact with the sample include FEP Teflon, acrylic plastic, ABS

plastic, EPR rubber, stainless steel, epoxy, polyether-imide, and the polyurethane cable covering.

- For correct probe operation, the gold cathode must always be bright. If it is tarnished (which can result from contact with certain gases) or plated with silver (which can result from extended use with a loose or wrinkled membrane), you need to restore its surface. You can return it to Teledyne Isco or clean it yourself with a probe reconditioning kit. (This kit is available from Teledyne Isco.) Never use chemicals or any abrasive not supplied with this kit. It is also possible for the silver anode to become contaminated, which will prevent successful calibration. Try soaking the probe overnight in a 3% ammonia solution; then rinse with deionized water, recharge with electrolyte, and install a new membrane. If you are still unable to recalibrate the probe after several hours, return the probe to Teledyne Isco for service.
- If the sensor O-ring is worn or loose, you should replace it. The probe comes with a kit of O-rings and replacement membranes. Additional replacement O-rings are available from Teledyne Isco in an O-ring replacement pack.
- If the probe will not be in constant use, you should store it in the plastic bottle provided in shipping. To keep the electrolyte from drying out, place a small piece of moist towel or sponge in the bottle and insert the probe into the open end. If you need service for your D.O. probe, Teledyne Isco recommends returning the unit for evaluation. In addition to servicing the probe, we can also provide advice on product applications, and you can also purchase other accessories for use with the D.O. probe. Use only 2-mil membranes with D.O. probes connected to Isco flow meters.

Table 4-4 D.O. Probe Technical Specifications

Cathode	Gold
Anode	Silver
Membrane	FEP Teflon; 2 mil standard
Electrolyte	Half-saturated KCl (Potassium Chloride)
Temp. Range	0° to +45° C
Polarizing Voltage	0.8 Volts (Nominal)
Probe Current in Air at 30° C	19 microamps (nominal)
Probe Current in Nitrogen at 30° C	0.15 microamps or less

Table 4-4 D.O. Probe Technical Specifications

Connection	12 ft. (3.2 m) cable with 5-pin male M/S connector
<p>Response time Typical response for dissolved oxygen, using supplied membranes, is 90% in 20 seconds. Response at low dissolved oxygen levels is typically 90% in 60 seconds.</p>	



Figure 4-7 D.O. Parameter Module

You must use the Isco Model 270 D.O. Module box between the probe and flow meter; this extends the distance between the probe and the flow meter to 1,000 feet.)

Note

The 270 D.O. Module has been discontinued. Probes, service kits, and accessories are still available to maintain existing field units.

4.9.6 Calibrating the D.O. Probe with a Flow Meter

Prepare the probe as described above if this has not already been done (fill the probe cavity with electrolyte and seat the membrane).

Note

You must use the Isco Temperature Probe with the D.O. Probe to provide temperature compensation.

Wrap both the D.O. Probe and Temperature Probe in a damp cloth. Wait ten minutes for it to stabilize, then proceed.

Go to **step 1** on the flow meter. Select PROGRAM, then step through the units of measure with **Enter** until you reach the menu for pH measurement. Select NOT MEASURED. Then D.O. UNITS will appear. Select either MG/L or PPM. Exit the program and re-enter going to **step 3**.

You must select measurement of D.O. in **step 1** or the D.O. menu will not appear in **step 3**. If you cannot get the D.O. menu to appear in **step 3**, recheck your selections in **step 1**. Remember that you must select NOT MEASURED for pH in **step 1** or D.O. will not appear on the menu for the rest of the program.

PARAMETER TO ADJUST
• NONE •• LEVEL •• D.O. •

Select D.O. The following will appear:

D.O. CALIBRATION
•D.O STANDARD••ABS BAROMETRIC PRESSURE••

Altitude is just off the screen. You can select D.O. STANDARD if this calibration medium is available to you. Do not select ABS (absolute) BAROMETRIC PRESSURE unless you are at sea level or know how to correct for this value. The barometric pressure provided from the Weather Bureau is corrected for altitude. Select ALTITUDE.

ALTITUDE UNITS OF MEASURE
• FT •• M •

Then:

ENTER ALTITUDE
ALTITUDE = XXXXX FEET (or meters)

Enter the altitude for your location. This is critical to the probe's accuracy. The following display will then appear:

WRAP D.O. PROBE IN MOIST CLOTH
PRESS ENTER WHEN STABLE: X.XXX MG/L

The reading is in milligrams of oxygen per liter. If you chose PPM in program **step 1** for D.O. units, the reading would be in parts per million.

4.10 Installation of Parameter Probes in Round Pipes

4.10.1 Spring Rings

Consult your Isco Mounting Rings instruction manual for detailed hardware information.

The following sections describe sensor installation using the two options available for mounting sensors in pipes or round-bottomed flow streams. For pipes up to 15" (38.1 cm) in diameter, **stainless steel self-expanding mounting rings (Spring Rings)** are available. For pipes larger than 15" in diameter, Teledyne Isco offers the **Scissors Rings (Universal Mounting Rings)**.

To install a spring ring, you compress the ring, slip it inside the pipe, and then allow it to spring out to contact the inside diameter of the pipe. The inherent outward spring force of the ring firmly secures it in place. A typical self-expanding mounting ring (with a probe mounted on it) is shown in Figure 4-8.

These mounting rings are available for use in pipes with inside diameters of 6" (15.2 cm), 8" (20.3 cm), 10" (25.4 cm), 12" (30.5 cm), and 15" (38.1 cm). The Isco part numbers for the various size mounting rings available are listed in Appendix A. These part numbers include not only the ring, but also the miscellaneous hardware necessary to mount the sensor on the ring.

CAUTION

Always wear leather gloves when handling the rings (either type). The metal is finished, but there is still a possibility of cutting your hands on the edges.

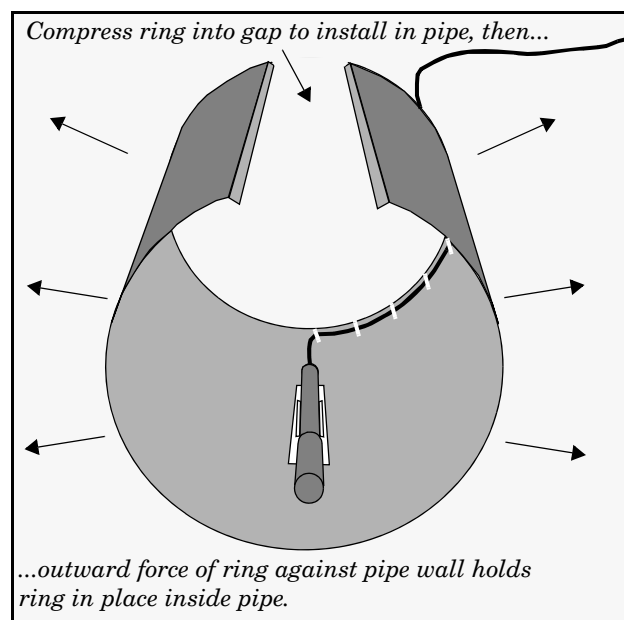

Figure 4-8 Sensor Installed on a Spring Ring

Completing the assembly

To complete the sensor-spring ring assembly procedure, attach the sensor cable to the downstream edge of the ring. Follow the cable routing shown in Figure 4-8. Other routing directions may affect measurement accuracy. The cable can actually create a stilling well downstream from the sensor, causing the level to read low. Use the self-locking plastic ties supplied with the ring. Install the ring in the pipe by compressing it. Press inward on both sides and slide the ring into the pipe.

Route the sensor cable out of the stream and secure it in position by placing the ties through the holes in the mounting ring and then locking them around the cable, as shown. To prevent debris from catching on the cable, it is important to attach the cable to the mounting ring so it offers as little resistance to the flow as possible.

The spring ring may need anchoring. Under conditions of high velocity (greater than 5 feet per second or 1.5 meters per second), the ring may not have sufficient outward spring force to maintain a tight fit inside the pipe. The ring may start to lift off the bottom of the pipe in a waving fashion, or may even be carried downstream.

This problem is more prevalent in the larger diameter pipes (10", 12", and 15", and in pipes with smooth inside surfaces, such as plastic pipes). If any of these conditions are present, or if movement of the mounting ring is detected or suspected, you must anchor the ring in place. You can do this by setting screws through the ring into the pipe, or by other appropriate means. If there is a problem with the smaller diameter rings, it may be sufficient to simply increase the outward spring force of the ring by bending it into a less round configuration.

4.10.2 Scissors Rings

For pipes larger than 15" in diameter, Teledyne Isco offers the adjustable Scissors Ring (also known as the Universal Mounting Ring). This device consists of two or more metal strips that lock together with tabs to form a single assembly. There is a base section where the sensors are mounted, one or more extension sections (usually), and a scissors section at the top that expands the entire assembly and tightens it inside the pipe. The scissors mechanism includes a long screw that increases the width as it is tightened.

The assembled rings fit pipe diameters from 16" to 80". Secure the unit in place by tightening the scissors mechanism with a $\frac{5}{8}$ " socket wrench or other suitable tool. Ring sections are .040" thick half-hard 301 stainless steel sheet. All other parts are also stainless steel, except for the plastic cable ties in the hardware kit.

Each extension, 1, 2, 3, and 4, adds 9.0", 21.5", 31.5", or 41.5", respectively, to the circumference of the ring. Used alone, the base section fits pipe that is approximately 16" to 18" in diameter. The 9.0" (the smallest) extension exists so that in larger pipe sizes, where large variations in circumference can

occur, you can use one or two of these extensions to take up or remove slack, to bring the scissors mechanism into a position where it can be effectively tightened.

Mounting ring kits are available for different pipe sizes. A kit is also available for partial pipe applications (see your Mounting Rings manual). For a listing of part numbers and ordering information, see Appendix A.

To prevent debris from catching on the cable, it is important to attach the cable to the mounting ring so it offers as little resistance to the flow as possible. Attach the sensor cable to the downstream edge of the ring, using the self-locking plastic ties supplied with the ring. Place the ties through the holes in the edge of the mounting ring and then lock them around the cable.

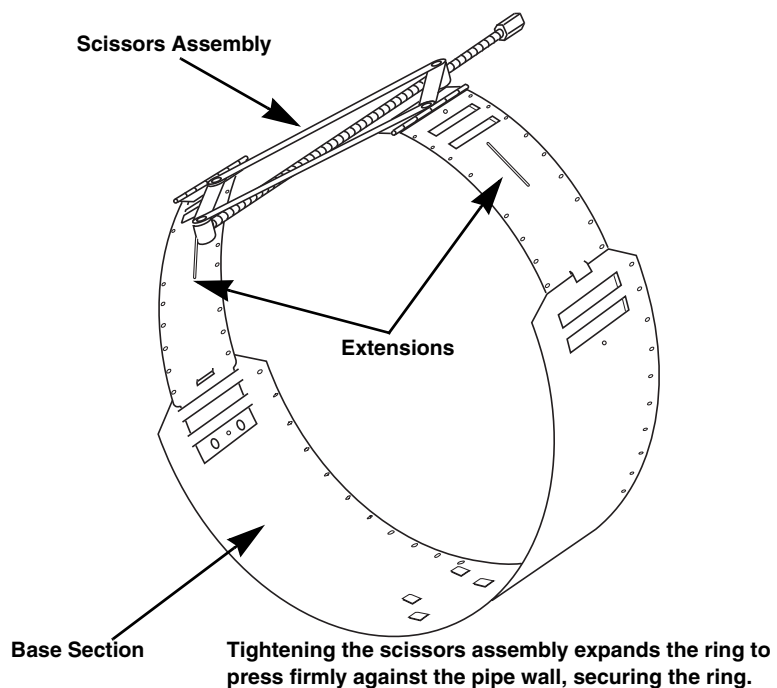

Figure 4-9 Scissors Ring Adjustment

4.11 YSI 600 Multiple Parameter Sonde

The YSI 600 Sonde is a multi-purpose, water quality measurement and data collection system. It is intended for use in research, assessment, and regulatory compliance. The YSI 600 Sonde can measure the following water qualities:

- Dissolved Oxygen
- Conductivity
- pH
- Salinity
- Total Dissolved Solids
- Temperature

The YSI 600 is ideal for profiling and monitoring water conditions in industrial and wastewater effluents, lakes, rivers, wetlands, estuaries, coastal waters, and monitoring wells. It can be left unattended for weeks at a time with measurement param-

eters sampled at your selected interval, and data transmitted to the flow meter. You can use the YSI 600 as deep as 200 feet below the surface, or in as little as a few inches of water. The fast sensor response of the YSI 600 makes it ideal for vertical profiling. Its small size means it can fit inside two-inch diameter monitoring wells.

A “Rapid Pulse Dissolved Oxygen Sensor” eliminates the need for stirring, providing accurate results without an expensive and bulky stirrer. Because no stirring is required, no supplemental power supply or battery is needed, and sensor drift caused by passive fouling is minimized.

The YSI 600 communicates with any 4200 Series flow meter equipped with suitable hardware and software. Earlier model 4200 flow meters can be factory-modified to work with the YSI Sonde. Data can be exported through Flowlink for further processing.

The YSI 600 is available with a cable 25 feet long that connects to the flow meter. The cables are waterproof at the sonde and can be used in lab or field.

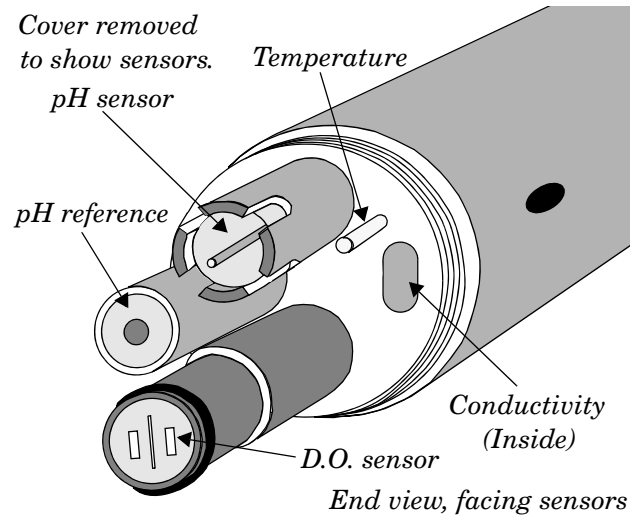

Figure 4-10 YSI 600 Multiple Sensor Sonde

Information about programming the flow meter to use the YSI 600 is found in Section 2 of this manual. Information about the YSI 600 Sonde is found in the YSI manual.

Table 4-5 YSI 600 Technical Specifications	
Operating Environment	
Medium	Fresh, Sea, or Polluted Water
Temperature	-5° to +45° C
Storage Temp	-40° to +60°C
Depth	0 to 200 Feet (0 to 61 meters)

Table 4-5 YSI 600 Technical Specifications (Continued)

Dimensions	
Diameter	1.6 Inches (4.06 cm)
Length	14 Inches (35.6 cm)
Weight	4.9 Pounds (2.22 kg)
Miscellaneous	
Materials	PVC, Stainless Steel
Computer Interface	RS-232C, SDI-12
Power	12VDC, Externally supplied
System Requirements	
Connects to <i>modified</i> 9-pin Rain Gauge Terminal on any 4200 Series Flow Meter. Operation of Rain Gauge with YSI 600 is still possible with a special Y-connect cable. Modification of older 4200 Series Flow Meters is possible with changes in connectors and boards. Consult Factory.	
Temperature	
Sensor Type	Thermistor
Range	-5° to +45° C
Accuracy	± 0.4° C
Resolution	0.1° C
Dissolved Oxygen % Saturation	
Sensor Type	Rapid Pulse - Polarographic
Range	0 to 200 % Air Saturation
Accuracy	± 2% Air Saturation
Resolution	0.1% Air Saturation
Dissolved Oxygen mg/L	
Sensor Type	Calculated from % air saturation, temperature, and salinity
Range	0 to 20 mg./L
Accuracy	± 0.2 mg./L
Resolution	0.01 mg./L
pH Salinity	
Sensor Type	Glass Combination Electrode
Range	2 to 14 pH Units
Accuracy*	± 0.2 Units
Resolution	0.01 Units
pH Salinity	
Sensor Type	Calculated from conductivity and temperature
Range	0 to 70 ppt

Table 4-5 YSI 600 Technical Specifications (Continued)

Accuracy	± 0.2 ppt
Resolution	0.1 ppt
Conductivity*	
Sensor Type	Four-Electrode Cell
Range	0 to 100 mS/cm
Accuracy	± (1% of reading + 0.001 mS/cm)
Resolution	0.01 mS/cm or 1 µS/cm
<p>*Specific conductance (conductivity corrected to 25° C), resistivity, and total dissolved solids measurements are also provided. These values are automatically calculated from conductivity according to algorithms found in <i>Standard Methods for the Examination of Water and Wastewater</i> (ed. 1989).</p>	

4.12 Mechanical Totalizer

A mechanical totalizer is available for the 4230 that consists of a seven-digit, non-resettable mechanical counter mounted in the front panel. It must be ordered with the flow meter. The totalizer advances according to program selections for units of measure and the maximum flow of the primary device used. The totalizer is internally set to advance at 1/100 of the rate of the display totalizer. Consequently, you must multiply the number shown on the mechanical totalizer by 100 to determine the actual value for total flow.

4230 Flow Meter

Section 5 Maintenance and Service

This section of the 4230 instruction manual provides routine maintenance and servicing instructions. Included are sections on cleaning the flow meter, reactivating the desiccators, maintaining the bubble line, servicing the internal printer, elementary troubleshooting, and servicing CMOS circuitry.

Teledyne Isco recommends that you become familiar with the maintenance procedures presented here. While the 4230 is ruggedly built to withstand severe field conditions, it will function best and remain most reliable if you follow these simple procedures.

5.1 Care of the Flow Meter Case

If you close and latch the lid, and cap all the M/S connectors on the side of the case tightly, you can clean the case by spraying it with a hose or washing it with soapy water. Do not use a hose with a nozzle or a high pressure hose-and-wand such as used at car washes. Do not immerse the flow meter in a tank of water to wash it. The flow meter will withstand accidental submersion in water, if that should occur, but it is not intended for routine submersion.

5.1.1 Care of the Case Seal

From time to time you should inspect the case seal and clean it, if necessary. The ridge around the edge of the case and the groove on the cabinet door form a seal when the door is closed. Keep this seal free of dirt, sand, etc. If it is not, clean it carefully with a damp cloth. Also keep the rubber gasket in the lid clean. You can clean it with a small brush and a damp cloth. If you do any cleaning while the case is open, be careful not to let any dirt or debris fall inside the flow meter assembly. It is best to work on the flow meter with the case standing upright. If you do not maintain the seals properly, they may leak, causing damage and eventual failure of the components inside.

5.1.2 Preventing Moisture Damage

To prevent moisture damage to the internal components, keep the lid tightly latched at all times, except when it is necessary to change the program or change the chart. Do not operate the flow meter routinely with the case open. This will expose the internal components to dirt and moisture; it will also saturate the desiccant canister inside the case very quickly. Inspect this canister periodically and recharge it as necessary as described subsequently. It is also important to keep the external connectors clean by keeping the mating connectors or the protective caps tightly screwed down. Under severe operating conditions you can spray the threads of the connectors with a cleaner/lubricant, such as Jif (manufactured by GC Electronics), or WD-40 (manufactured by the WD-40 Company) to prevent corrosion. Be careful not to

spray any of the terminals (pins or jacks) inside the connectors; residue from the sprays could cause intermittent or failed connections.

5.2 Desiccators

The 4230 has a reusable desiccant canister held by a steel clamp on the inside of the case lid. There is also a tubular desiccant cartridge on the top of the case next to the connectors. The canister contains silica gel that adsorbs moisture trapped inside the flow meter's case when it is closed. This keeps the inside of the case completely dry during shipment, storage and use. If you leave the case open, the desiccant will quickly absorb moisture from the surrounding air and will soon be saturated. It will no longer be able to protect the flow meter. Both desiccators use a color indicator that changes from blue to pink or yellow when saturated. The external desiccant cartridge vents the reference port of the pressure transducer and the air intake port for the bubbler system air pump.

5.2.1 Regenerating the Internal Case Desiccant

Look at the desiccant canister each time you open the case. The canister has a window on its side that appears blue or yellow when the desiccant is dry. As the desiccant absorbs moisture, the window will turn pink or green. When the window is pink or green, you need to regenerate the desiccant, or replace it with the spare canister provided in the flow meter accessory package. Remove the canister from the flow meter by pulling outward on the spring clamp, releasing its hold on the canister.

Remove the canister and heat it in a **vented** oven in a well-ventilated room at 300°F (150°C) for about three hours, or until the blue or yellow color returns. **Do not use a microwave oven;** the metal case of the canister could cause arcing. After cooling, reinstall the canister in the flow meter. Make sure the window on the side of the canister remains visible.

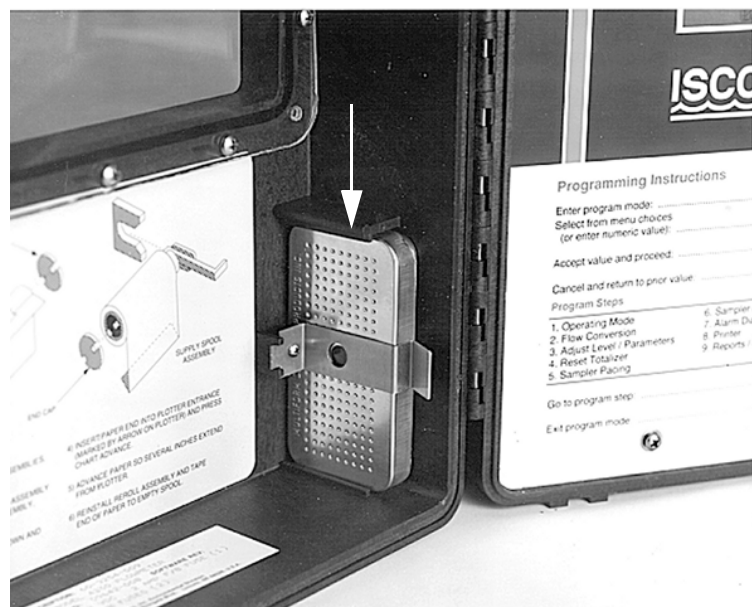

Figure 5-1 Location of the Case Desiccating Canister

5.2.2 Regenerating the External Desiccant Cartridge

Teledyne Isco uses two types of silica gel:

- One chemical looks like small beads or pellets that are blue-black when dry, pale pink to transparent when saturated.
- The other chemical looks like coarse sand, yellow when dry, dark green when saturated.

Regenerate desiccant by heating at 212° - 350° F (100° - 175°C).

MSDS (Material Safety Data Sheets) for silica gel chemicals are provided at the back of this manual.

To regenerate the desiccant cartridge:

1. Snap it out of its bracket.
2. Pull the silicone tubing from the end of the cartridge.
3. Remove one of the end caps from the cartridge by twisting and pour the saturated desiccant into a metal, ceramic, or other heat-resistant container.
4. Identify the desiccant and heat it at the proper temperature two to three hours, or until the blue or yellow color returns.
5. Do not try to regenerate the desiccant inside the cartridge; the cartridge is plastic and will melt.
6. Refill the cartridge with the regenerated desiccant (or with the extra desiccant provided in the accessory package).
7. Replace the end caps. If you have difficulty removing or replacing the end caps, you can coat the O-rings with a small amount of silicone oil. (Do not use any other type of oil; it may attack the plastic.)

Notice the filters in the end caps; they keep small pieces of the desiccant material from falling out of the cartridge. Clean these filters from time to time using ordinary dish soap and water, and allow to dry.

 CAUTION
--

There have been reports of irritating fumes coming from the desiccant during regeneration. While our attempts to duplicate the problem have been unsuccessful, we still urge you to use caution.

- Use a vented oven in a well-ventilated room.
- Do not remain in the room while the regeneration is taking place.

Regeneration of the desiccators is extremely important. While it is true that the equipment may run for some time with saturated desiccators, the operating environment of many installations places the units at risk. Please consider the following:

 **Note**

Saturated desiccators let the flow meter draw moisture inside, exposing both mechanical and electronic components. The air in many installations contains fumes that will form acids in the presence of moisture. These acids may corrode electrical components, particularly connectors and circuit boards.

Operation of the air pump in low temperature, high humidity environments causes ice to form inside the pump. The ice formed could jam the pump, ruining it.

Unseen damage caused by moisture will eventually ruin the flow meter. For maximum equipment life and reliability, inspect the desiccators regularly and regenerate them when necessary.

5.3 Bubble Line Maintenance

Periodically inspect the bubble line from the 4230 to make sure that it has not become kinked, frayed, cut, nicked, or damaged in any other way. If you find damage to the bubble line, replace it. A leaking or obstructed line will cause inaccurate level readings and lower battery life. (The pump must run more frequently.) Look for a pump duty cycle value in the STATUS menu higher than 20%. If you need to replace the bubble line, install a new line the same way you installed the original. Generally, the new line should be the same length and diameter as the old.

 **Note**

If you replace the bubble line or if you change the outlet either by cutting off the tip or by installing a bubble line extension, you must recalibrate the level. You should also recheck the bubble rate to make sure it has not changed.

5.3.1 Inspection of the Bubble Line Outlet

Inspect the outlet of the bubble line regularly for any signs of clogging. Sediment or debris from the flow stream and algae can all clog the line. If the line is blocked, you can either clean it out, or simply cut off the tip.

If clogging proves to be a recurring problem, you may want to use a bubble line with a larger inside diameter. However, you will usually find it preferable to increase the frequency of **Purge** to increasing the size of the bubble line.

If you decide to change the bubble line size, consult the factory for specific recommendations regarding the size of the line, connectors required, etc.

If algae growth is a problem, consider using a copper bubble line extension. The copper salts formed on the line by the flow stream are algicidal. Again, recheck the bubble rate and re-enter the actual level measurement.

5.3.2 Automatic Air Purge

The 4230 has an automatic purge feature to clear deposits from the bubble line with a sharp burst of air from the pump. Purge is intended to help keep the outlet of the bubble line open. The program substep PURGE INTERVAL (in Setup) allows you to set the time between purge cycles, from five minutes to one hour.

The **Purge** key on the keypad lets you manually purge the bubble line anytime just by pressing the key. You don't have to wait until the next programmed purge cycle occurs to purge the line.

When you press **Purge**, the pump will start running inside the flow meter. The pump will continue to run as long as you press the button, and for a short while after you release it.

5.4 Maintenance of the Printer

The internal printer needs little maintenance beyond changing the chart roll and the ink ribbon.

Refer to the pictures provided for each section. Also refer to the label inside the cabinet.

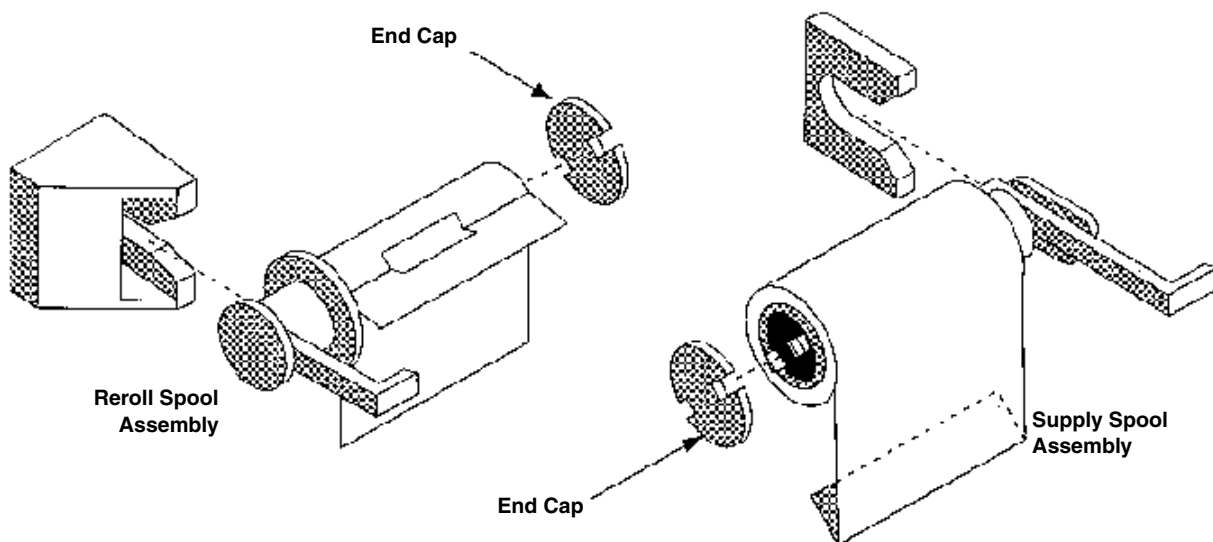

Figure 5-2 Changing the Chart Paper

5.4.1 Changing the Paper Roll

To change the chart paper you will need:

- new roll of paper
- a knife or a pair of scissors
- a small piece of tape

The printer will shut down when the paper runs out. The roll is nearly empty when a 1-inch wide pink band appears on the left side of the chart.

To change the roll:

1. Locate the handle on the left side of the take-up roll.
2. Pull straight out on this handle until the take-up roll slips off the printer.

3. Remove the paper roll from the take-up spool by holding the handle in one hand with your thumb pressed against one of the slots in the white end cap.
4. Snap the white end cap free from the two black catches on the end of the spool.
5. Pull the paper roll off the spool with your other hand.
6. Remove the feed spool by pulling on the handle extending from the right side of the printer.
7. Snap off the other white end cap as described previously. Save the white end caps; you will reuse them.
8. Remove the empty roll from the spool by holding the handle in one hand and pulling the roll from the spool with the other.

Installing the New Roll of Paper

After you remove the empty roll:

1. Slide the new roll onto the feed spool so it unrolls from the back side - facing away from you.
2. Line up the slots in the cardboard tube with the raised guides on the spool.
3. Reattach the white end cap by wedging the two catches on the end of the spool into the two slots on the white end cap.
4. Peel the paper back gently so it will unroll freely. Using the knife or scissors, cut off the end of the roll if it is torn.
5. Fold the paper over on itself so the end is straight and stiffer than a single layer of paper would be.
6. Unroll a few inches of the paper and set the roll on top of the cabinet.
7. Use your fingers to feed the paper down the back of the internal printer to where it touches the roller. Make sure the paper gets past the lever for the paper sensing switch.
8. Press the Chart Advance key and hold it until the paper comes through the printer mechanism.

Re threading the Paper

1. When the paper comes through, reinstall the feed spool with the new roll on it by snapping it into the printer assembly.
2. Run a few inches through the printer, using the Chart Advance key; then unfold the end.
3. Put the cardboard tube from the empty roll on the take-up spindle and reattach the white end cap by wedging the catches on the end of the spool into the two slots on the white end cap.
4. Use the piece of tape to attach the end of the new paper to the cardboard tube from the old roll.
5. Roll some of the paper onto the spool so that it will wind clockwise, facing away from you. Then reinstall the take-up roll into the top of the printer.

6. Be careful to push it all the way back in, so that the take-up gear on the end of the spool assembly will reengage.
7. When the take-up spool is back in place, again push the Paper Reroll key; this will remove any slackness in the paper.

5.4.2 Ink Ribbon Replacement

Ribbon life will vary greatly from one installation to another depending on how often the printer has to print. When the characters on the chart become difficult to read, you should replace the ribbon. If possible, try to replace the ribbon at the same time you change the paper roll, as it is easier to replace the ribbon when the roll of paper is out of the way.

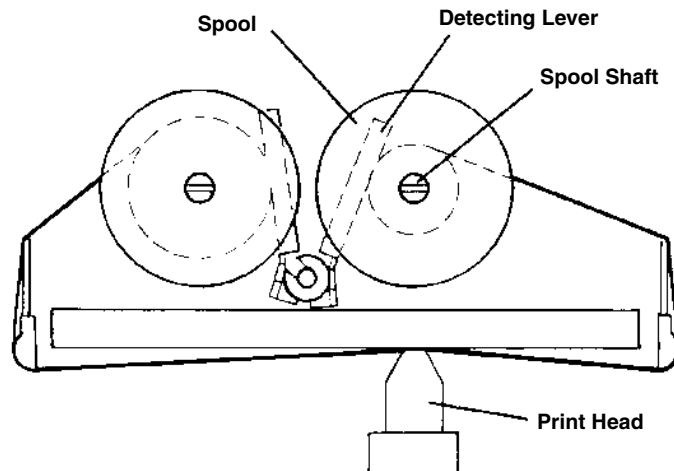

Figure 5-3 Ink Ribbon Replacement

To replace the ribbon:

1. Turn the unit off.
If there is paper in the unit, remove the take-up spool and unroll enough paper to get it out of the way, so you can clearly see the two ribbon spools. Each spool has a ribbon-detecting lever pressing against the ribbon. Note the direction the ribbon leaves the left spool and how it winds onto the right spool.
2. Grasp one of the spools and rotate it slightly, loosening the ribbon.
3. Lift gently until the spool comes free from its shaft. Do the same with the other spool.
4. Lift the chart and take-up spool out of the way and remove the ink ribbon from the printer mechanism, noting how it threads through the unit.
5. Thread the new ink ribbon through the printer mechanism.

6. Locate the three small pins on each spool of the ink ribbon and turn the spools so the pins face the gears on the two ribbon shafts.
7. Replace the two spools on their respective shafts, pushing the detector levers out of the way so the spools will easily re-engage their gears.
8. Gently rotate each spool to tighten the ink ribbon. Reinstall the paper take-up roll if necessary.

5.4.3 Do Not Lubricate or Disassemble

You do not need to oil the printer mechanism. As long as you keep the lid closed, keep the inside of the cabinet clean, and do not abuse the printer in any way, it should function normally. Teledyne Isco recommends you make no attempt to oil or disassemble the mechanism if it malfunctions.

Oil attracts dirt; some oils can become gummy over time and may cause parts to bind or stick. Do not attempt to disassemble the printer mechanism, as you may bend or distort the frame or component parts. This will certainly cause malfunction.

Do not force any part of the mechanism with tools or probes. If you disassemble the flow meter, do not lift the chassis from the case by holding on to any part of the printer. The internal printer contains no user-serviceable parts other than the paper and the ribbon. If the printer needs service, Teledyne Isco recommends you return the flow meter to the factory.

5.5 Servicing And Troubleshooting

The remainder of this section provides servicing information and a general troubleshooting guide. This information will help you decide whether to attempt to repair the flow meter yourself or return it to the factory.

Included are sections on removing the flow meter chassis, fuse replacement, and an explanation of the components of the bubbler system. There are also general comments on servicing electronic equipment with special consideration of CMOS circuitry.

5.5.1 Disassembling the Flow Meter

You can remove the flow meter chassis from the cabinet for inspection and servicing. Unscrew the four screws, two at the top, and two at the bottom, that hold the flow meter chassis in the cabinet. You can then lift the chassis out by inserting the thumb or index finger from each hand into the upper right and lower left corners of the opening for the internal printer.

Do not try to lift the flow meter out of its case by holding on to any part of the printer mechanism. This could bend or distort part of the printer, possibly damaging it. Once the chassis has cleared the case, you can hold onto the edges with both hands and lift it free of the case.



Figure 5-4 Lifting the Flow Meter from the Case

Note

If you disassemble the flow meter for servicing, you will also remove the aluminum chassis covers to access the circuitry. Always replace these covers when repairs have been completed. The covers protect the circuit boards and also reduce signal emissions that could interfere with the operation of nearby electronic equipment. For the same reason, do not remove any of the ferrite beads or alter the wiring harnesses inside the cabinet in any way.

5.5.2 Fuse Replacement

With the flow meter chassis out of the cabinet, you can locate and change fuses. The fuses are located on the printed circuit board directly behind the keypad. There is an aluminum cover over this board. Remove the cover by pressing against its surface with the palm of your hand and then pulling downward on it with your fingers. A plastic catch under the cover holds it in place. The fuses are labeled **F1**, **F2**, and **F3**. The proper size for each of these fuses is:

F1 - 5 amp., fast blow

F2 - 5 amp., fast blow

F3 - 2½ amp., fast blow

Always replace a blown fuse with one of the same value. Using a larger value of fuse could cause serious damage to the flow meter or to its power supply. Replace the protective cover, making sure

the two ears on top of the cover slide into the mating slots on the chassis. There should be a noticeable snap when the plastic catch re-engages the cover.

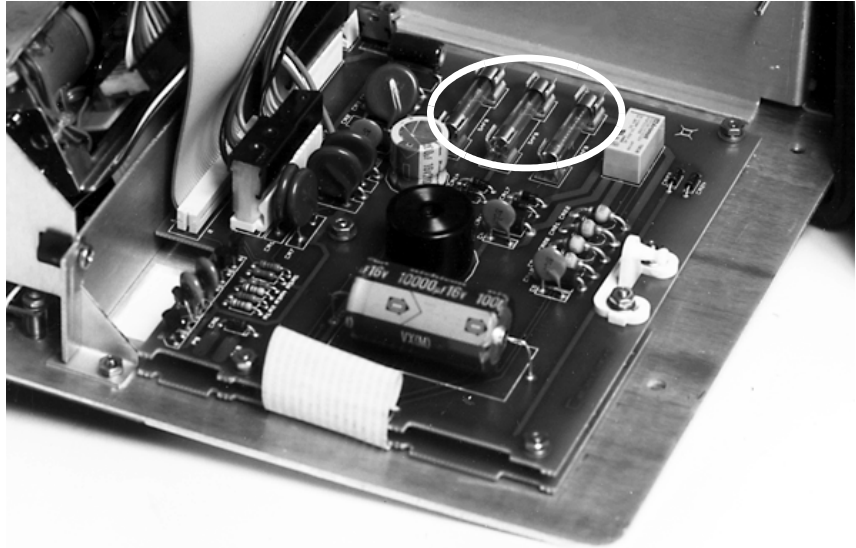

Figure 5-5 Location of the Three Fuses

5.5.3 Display Warnings

The LCD will show various warnings and error messages to warn of problems in the program, or difficulties inside the flow meter. Some messages request routine maintenance; others point out programming errors; still others indicate serious internal difficulties.

Following are typical warning messages displayed by the LCD:

CHECK PRINTER FUSE

PRINTER JAMMED

PAPER OUT

5.6 System Reset

If the flow meter does not appear to be operating normally, you can try to restart the processor by turning the unit off, waiting a few minutes, and then turning the unit back on. If that does not work, you can (software) reset the system by pressing both the **4** and **Exit Program** keys at the same time while the unit is powering up.

Pressing **4** and **Exit Program** only works when the unit is powering up; it has no effect when the unit is running.

Note

Pressing **4** and **Exit Program** when powering up will cause most programmed entries to be lost. Accumulated data stored in the 4230 will also be lost.

The flow meter will revert to the program originally entered at the factory. If this operation is performed, it will be necessary for you to reprogram the unit to meet the specifications of your installation. For this reason, it may be a good idea to keep a record of how you programmed the unit. The **Print Program** feature will do that for you.

Pressing **4** and **Exit Program** may leave some values programmed into the flow meter's computer. If you want to remove all programmed entries, press **1** and **Clear Entry** when the flow meter is powering up.

The following messages describe serious internal problems, indicating service is required:

ROM CHECKSUM ERROR - or -
FOUND BAD RAM - CALL CUSTOMER SERVICE

If these messages appear, the Teledyne Isco Technical Repair Department should be called for instructions at (800) 775-2695 or (402) 464-0231.

 CAUTION

Do not attempt to disassemble or repair the 4230 Flow Meter (other than changing fuses) unless you are skilled in the evaluation and repair of microprocessor-based circuitry. Teledyne Isco recommends no attempt be made to disassemble or repair the printer mechanism or display module.

5.7 Operation of the Bubbler System

This system produces the pressurized air supply for the bubbler, regulates the rate of air to the bubbler tube, measures the pressure in the bubbler tube, does purge, drift compensation, and other functions.

5.7.1 Internal Air Pump

A small, high-efficiency pump generates the pressurized air supply for the bubbler. The suction side of the pump connects to the outside of the case through the pump inlet port barbed hose connector. This vent is separate from the other components to prevent interference from the pumping cycles. The exhaust side of the pump connects to the air supply tank, which is pressurized by the pump.

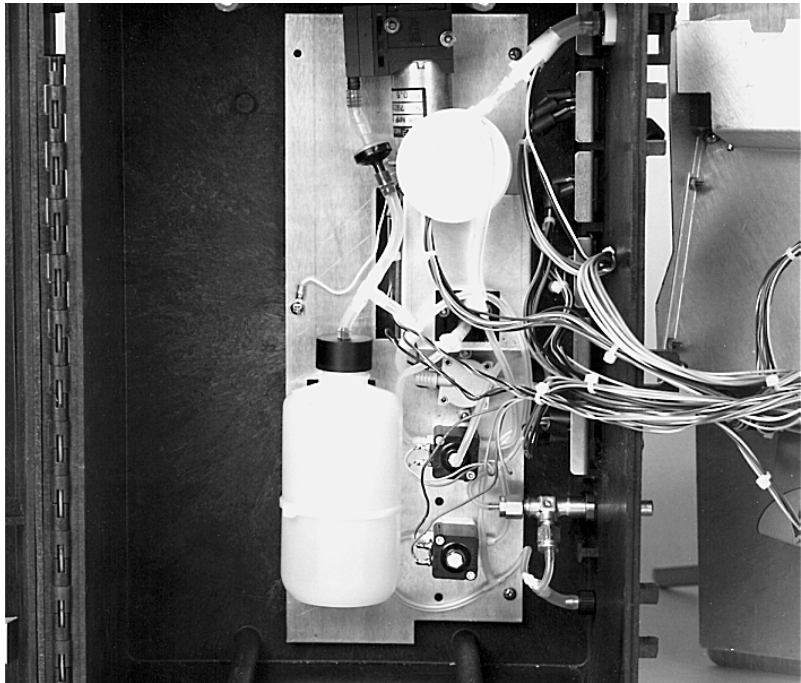

Figure 5-6 4230 Bubbler System Pressure Control

A fixed set-point pressure switch monitors air pressure in the tank. The reference side of this differential pressure switch connects to the bubble line. When the pressure in the tank falls below 3.5 psig above the water pressure being measured, the pressure switch turns the pump on for a fixed period of time. Thus, the system maintains pressure in the tank at approximately 3.5 psig above the current water pressure.

5.7.2 Air Output to Bubble Line

The output from the air supply tank leads to the bubble line tubing connector on the side of the case. The bubble line attaches to the flow meter through this connector. The pressurized air in the tank can take two possible paths to the bubble line. The normal route is through the **Bubble Rate Adjust** valve. This adjustable, fine-metering valve controls the rate of air escaping from the bubble line, establishing the bubble rate. The adjustment knob of this valve is on the outside of the flow meter case, allowing external adjustment of the bubble rate.

5.7.3 Purge

The other path air can take to reach the bubble line is through the bypass Purge valve. Purge is an electrically-operated valve. When this valve turns on, air bypasses the Bubble Rate Adjust valve and discharges directly into the bubble line. This valve also opens momentarily to release bursts of air when the pressure transducer detects a rapidly rising liquid level.

The flow meter normally operates with a battery-saving low bubble rate, but these air bursts allow fast response to a sharply rising liquid level. This quick-response feature is called **Super Bubble**.

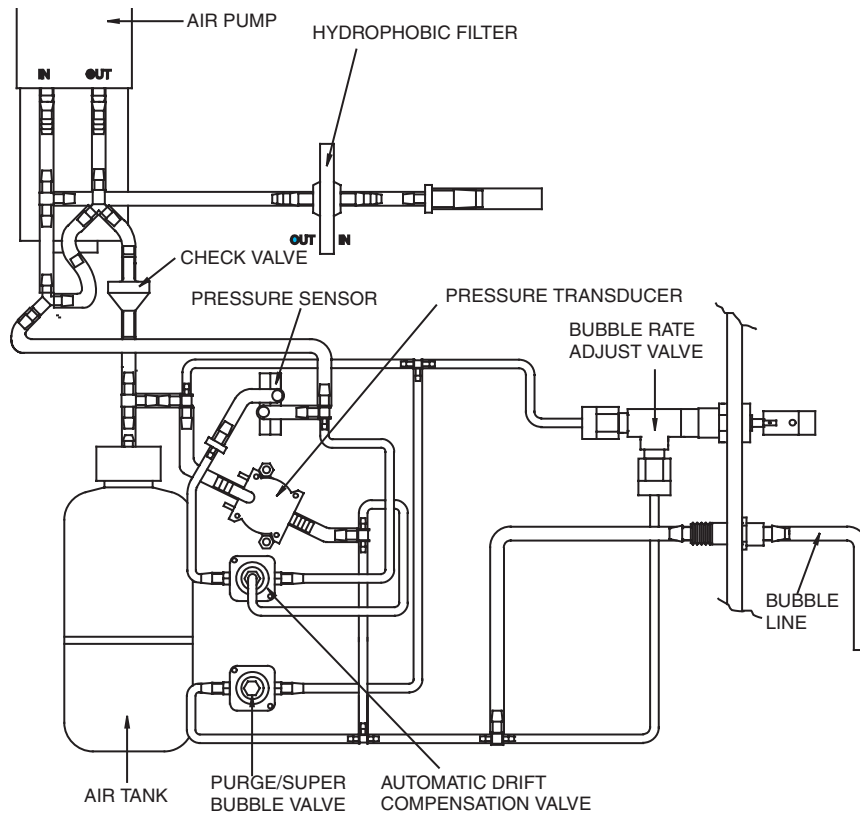

Figure 5-7 Schematic Diagram of the Bubbler System

While the purge valve pulses for short cycles to produce the Super Bubble, it also opens to produce longer discharges of air at intervals selected from the program, or you can operate it manually through the use of the manual Purge switch on the keypad. The purpose of the purge feature is to clear deposits from the bubble line that build up over time and could eventually cause clogging.

5.7.4 Pressure Transducer

A temperature-compensated solid-state pressure transducer measures the air pressure in the bubble line. The pressure is proportional to the level. The pressure transducer connects to the bubble line through the automatic drift compensation valve. The reference side of this transducer vents to the outside of the case through the external desiccator. The microprocessor converts the output from this transducer into level and flow rate.

5.7.5 Automatic Drift Compensation Valve

This valve, located directly across both ports of the pressure transducer, turns on at power-up and from time to time after that to tie the input and reference ports of the transducer together to compensate for any drift that might occur. The software determines how often this valve turns on.

5.8 Preliminary Troubleshooting Steps

 CAUTION
--

Do not attempt to disassemble or repair the 4230 Flow Meter (other than changing fuses) unless you are skilled in the evaluation and repair of microprocessor-based circuitry. Teledyne Isco recommends no attempt be made to disassemble or repair the printer mechanism or display module.

The electronic circuitry of the 4230 is solid-state and its reliability is high. If the unit should fail to operate properly, the problem is most likely a mechanical failure. Items such as a broken or intermittent connection in the power cable or wiring harness or (rarely) poor electrical connection through keypad switches should be suspected.

5.8.1 If Serious Problems Occur

If you suspect an electronic problem, Teledyne Isco strongly recommends that you call the Teledyne Isco Technical Repair Department. **(800) 775-2965** or **(402) 464-0231** outside the U.S.A. The service department will advise you on how to return the 4230 to the factory for servicing.

The Technical Repair Department has trained technicians and specially-designed equipment necessary for timely, efficient repair of the 4230 Flow Meter. If you still wish to attempt repairs, the Technical Repair Department is available to provide additional advice and information on servicing.

5.8.2 Processor

When attempting to isolate problems within the unit, you should assume that the CPU and memory are working properly until attempts to find problems in the peripheral circuitry have been exhausted.

This is for two reasons: First, the likelihood of failure is far greater on transistor drive circuits (heavier currents are handled here), than on the CPU or memory. Second, it is doubtful that the repair facility would have the time or equipment to do worthwhile troubleshooting (beyond exchanging components) on the CPU or memory.

When the unit does not work, do not automatically assume the CPU is at fault. Following are suggested areas to check before attempting to service the CPU and associated circuitry. Telephone consultation with Teledyne Isco Technical Service is strongly recommended. Look for the following:

1. First verify that the problem is in the flow meter and not caused by the bubble line, power supply, or any other equipment connected to the flow meter.
The flow meter could be all right and will appear not to work because of a clogged or leaking tube or other component; check these first.
2. Check to see if any fuses are blown
3. Check the battery or power supply.
Proper voltage to the unit should be from 10.5 to 14.5 VDC.

If the unit is powered from the AC supply, make sure the branch circuit is delivering at least 110 VAC to the power supply cord.

4. Check the wiring harnesses, connectors, and solder joints. Under normal conditions, these should stay in good condition. However, abuse or operation of the unit with the door open or the desiccator saturated could cause corrosion of the connectors in certain atmospheres.
5. Look for physical damage. Burnt or broken components, overly hot components, stuck or inoperative switches, or the evidence of water damage, again brought about by neglect or abuse, may be apparent if you look closely.
6. Look for shorted or open diodes and transistors, especially driver transistors.
7. Check the voltage regulators. The output voltage from the regulators should be within 5% of their rated value. Check to see that rated voltages are available at various places on the boards.
8. Look for excessive current draw from some or all the circuitry. This will usually be accompanied by an unusual amount of heat coming from some component or group of components, and the voltage on the power rails may be depressed.
9. Make sure the air pump and associated circuitry are functioning correctly. Check both the electronic and pneumatic circuits. A leaky piece of tubing will seriously affect accuracy.
10. Check to see that the crystal oscillator is operating and at the proper frequency.
11. Check the reset circuitry to see that it is working properly.

5.9 Precautions for Servicing CMOS Circuitry

Most of the circuitry in the 4230 Flow Meter is made up of CMOS components. Because of the oxide gate structure of these devices, they are extremely susceptible to destruction caused by the discharge of static electricity through their inputs.

Many of the driver transistors in the 4230 are power MOS devices; they are just as susceptible to static damage as CMOS ICs are. Because of this risk, certain precautions must be taken when working on these circuits.

5.9.1 Hazard of Static Electricity

The voltage levels present from static buildup due to walking over carpeted floors, movement of woolen or synthetic clothes over chair seats, workbenches, etc., are high enough to destroy CMOS circuitry when performing repair work.

Ideally, all tools, soldering irons, etc., should be grounded, and work should be conducted on a grounded metal workbench, with grounding straps worn on the wrists of personnel. It is recognized that in most field repair situations, such precautions are impractical. However, certain extreme hazards must be avoided.

- Never perform any work in a room with a carpeted floor.
- Always roll up your sleeves so that your arms are in contact with the working surface.
- Avoid using a work surface made of an extremely good insulator.
Plastic or glass are good insulators and should be avoided. A metal surface is best; a wood surface is acceptable. Conductive grounding mats are available for work stations and are worthwhile if much repair is to be done.
- The degree of hazard depends on the level of humidity. Be particularly careful if the work area is extremely dry, or if the work is being done in the winter, when indoor forced heating and outdoor low temperatures cause the relative humidity level to be very low.
- Keep yourself grounded when handling disassembled equipment.
When arriving at the work area, after a unit has been opened for repair, make an effort to always be touching the metal chassis before touching any of the circuit components.
- Be especially careful handling the CMOS integrated circuits when they are removed from the rest of the circuitry.
Simply being connected to the rest of the circuitry provides some protection. Most of the circuitry is well-protected from damage caused by static discharge when the unit is powered up. However, an IC should never be replaced when the unit is turned on.
- Individual CMOS semiconductors and built-up printed circuit boards should always be transported in conductive packaging.
Foil is satisfactory; metallized plastic bags are also available and work well. Ordinary plastic bags and pink poly are not satisfactory unless the legs or leads are also stuck into a block of black conductive foam. If replacement components that are purchased do not come in marked, protective packaging, do not use them. They may already be destroyed.
- Once assembled and soldered, printed circuit boards are easily damaged by improper repair procedures.
Do not attempt to remove components, particularly ICs, from printed circuit boards unless skilled at this procedure. A defective component may be located, changed, and the unit still not work, if excessive heat or pressure has broken the foil traces or pulled the cores from holes on the board.

5.10 Using FLASH UPDATE

Teledyne Isco manufactures a number of instruments - 4100 Series Flow Loggers, 4200 Series Flow Meters, and 6700 Series Samplers - that use circuitry based on FLASH EPROMs. Unlike earlier EPROMs that require UV erasure and were not easily field replaced, the FLASH EPROM lets you upgrade the software in the instrument without opening the unit or returning it to the factory. You can now update the software with a disk from Teledyne Isco, an IBM®-compatible personal computer and a connect cable.

The disk contains UPDATE, a program specifically for flash memories, and a set of software files to update the FLASH EPROM.

Each disk is labeled with:

- The instrument series number
- The software revision number for each instrument in the series
- The part number of the disk

5.10.1 Getting Started

The following instructions assume that:

- You have had some experience using the computer.
- You have a Computer Connect Cable. If you do not have the cable, order it from your sales representative or the factory. For more detailed information about hardware requirements, see Table 5-1 on page 5-20.
- You are familiar with Microsoft® Windows®. FLASH UPDATE uses the standard Windows user-interface for mouse and keyboard commands. If you are unfamiliar with DOS or Windows, please read your DOS or Windows user manuals.

5.10.2 Before Running FLASH UPDATE

The windows in FLASH UPDATE contain all the instructions you need to update the instrument. However, there are a few things to consider before running the program.

- **Updating your instrument erases the data stored in its memory.** This includes all readings and most of the program settings. FLASH UPDATE replaces most program settings with factory settings. Before running the program, collect the data and record your program settings. Then, after updating the software, reprogram the instrument.
- **If you have Flowlink, Teledyne Isco strongly recommends using it to update 4200 Series Flow Meters.** Flowlink lets you collect the data stored in the instrument before updating the software. It also leaves the program settings in the instrument unchanged, eliminating the need to reprogram them. Then Flowlink updates the software, it uses the update files on the FLASH UPDATE disk and disregards the FLASH UPDATE program. Refer to the Flowlink Help files for

more information. Use FLASH UPDATE only if you do not have Flowlink available.

- The instructions in the following section, Running FLASH UPDATE, assume you are running the program from the update disk. However, you may prefer to copy the disk's contents to your hard disk. Before copying the disk, create a new directory for the FLASH UPDATE program and the update files. The program and the update files must be in the same directory. Furthermore, that directory must be the current directory when you run the program.

If you receive several update disks over time, copy the update files and the program when copying the contents of a disk. This ensures that you have a current version of FLASH UPDATE as well as the new update files. Depending on your selection in the preferences window, you may see the window in the margin (left) listing all files in the directory. This window appears only when the directory or disk contains more than one version of the update files and the Preferences option for Show Update File is "All Update Files." (See About Preferences.)

5.10.3 Running FLASH UPDATE

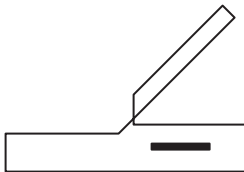

Interrogator Icon

1. Connect the Computer Connect Cable to your computer's serial port and the instrument's interrogator connector (marked with the Interrogator icon).
2. Insert the update disk in the floppy disk drive.
3. Change the DOS prompt to the floppy disk letter prefix.
4. At the DOS command line, type: FLASHLD. The first window in FLASH UPDATE will be the Introduction window. Read it carefully before continuing.

5.10.4 About Preferences

FLASH UPDATE has a set of factory settings that appear in Figure 5-10. Change them when your computer requires different settings.

To change preference settings:

1. Click Cancel in the Introduction window.
2. Select Preferences from the Options menu. The notes in Figure 5-10 explain the selections in the window. When you have selected your preferences, select OK.

Select Update Software from the Options menu, and follow the instructions in each window.

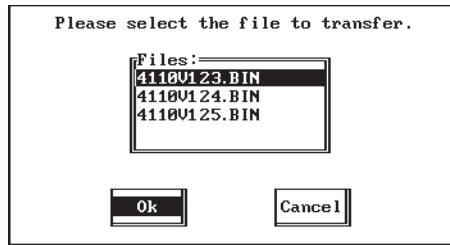

This window appears only when the directory or disk contains more than one version of the update files and the Preferences option for Show Update File is "all Update Files." It lists the update files in the directory. The first four numbers in the file name are the instrument's model number. The numbers following the "V" are the software version. If several versions appear in the window, select the version with the highest number unless otherwise instructed by Teledyne Isco Technical Service.

Figure 5-8 Update File Menu

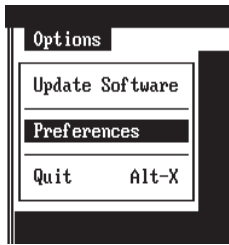

Options Menu

Figure 5-9 Options Menu

Select the COM port that corresponds to the serial port used for the Computer Connect Cable.

Select Newest Version to see only the most recent update files in a directory. Select All Update Files to see all update files.

Select the color scheme that best matches your monitor.

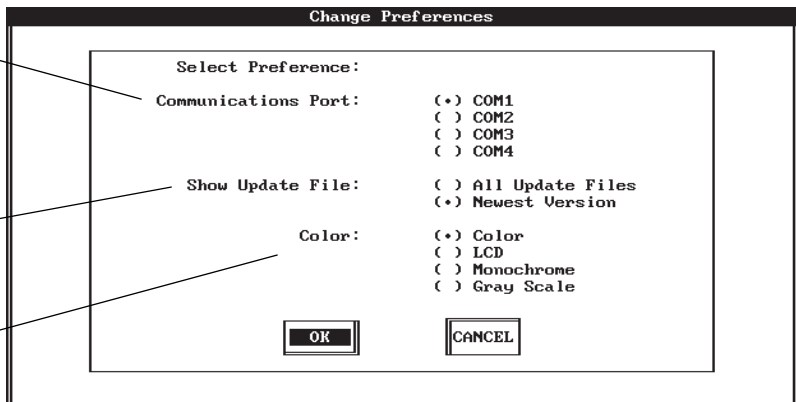

Figure 5-10 Preferences Window

Table 5-1 Minimum DOS and Computer Hardware Requirements

DOS	DOS 3.3 or later versions	DOS 5.0 or later versions recommended. Microsoft Windows not required.
CPU	80286, 80386, 80486	IBM PC or compatible. 80386 or 80486 recommended. (Must operate at 19,200 baud when communicating through the serial port.)
	640 kilobytes RAM (Random Access Memory), minimum	
	Serial port	For connecting the computer to Isco flow meters, flow loggers, or samplers.
Keyboard	Any compatible keyboard	
Hard disk	Not required.	
Floppy disk	3 ¹ / ₂ -inch floppy drive (1.44 mega bytes)	At least one floppy disk drive.
Monitor	LCD, Gray Scale, Color, or Monochrome	IBM CGA, EGA, or VGA compatible.
Mouse	Microsoft®-compatible mouse	Optional. Mouse recommended.
Cabling	Isco Computer Connect Cable (9-pin: part #60-2544-044) (25-pin: part #60-2544-040)	For connecting the computer to flow meters, flow loggers, or samplers.

4230 Flow Meter

Appendix A Accessories and Replacement Parts

A.1 Replacement Parts

The following section contains illustrations and corresponding tables of 4230 Flow Meter replacement parts. A list of accessories and optional equipment can be found at the end of this section.

Replacement parts can be purchased by contacting Teledyne Isco's Customer Service Department.

Teledyne Isco, Inc.

Customer Service Department

P.O. Box 82531

Lincoln, NE 68501 USA

Phone: (800) 228-4373

(402) 464-0231

FAX:(402) 465-3022

E-mail: IscoInfo@teledyne.com

4230 Flow Meter
 Appendix A Accessories and Replacement Parts

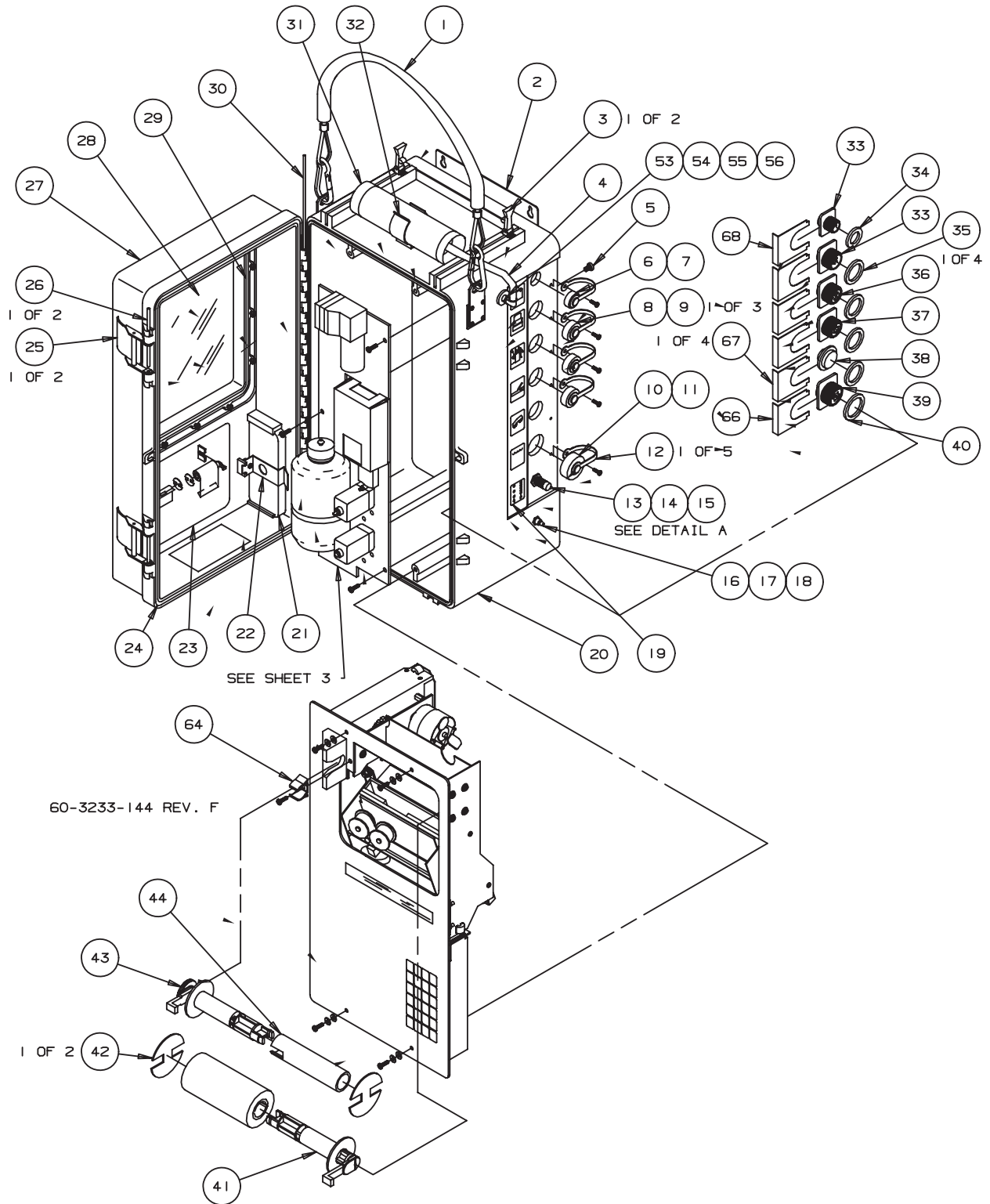

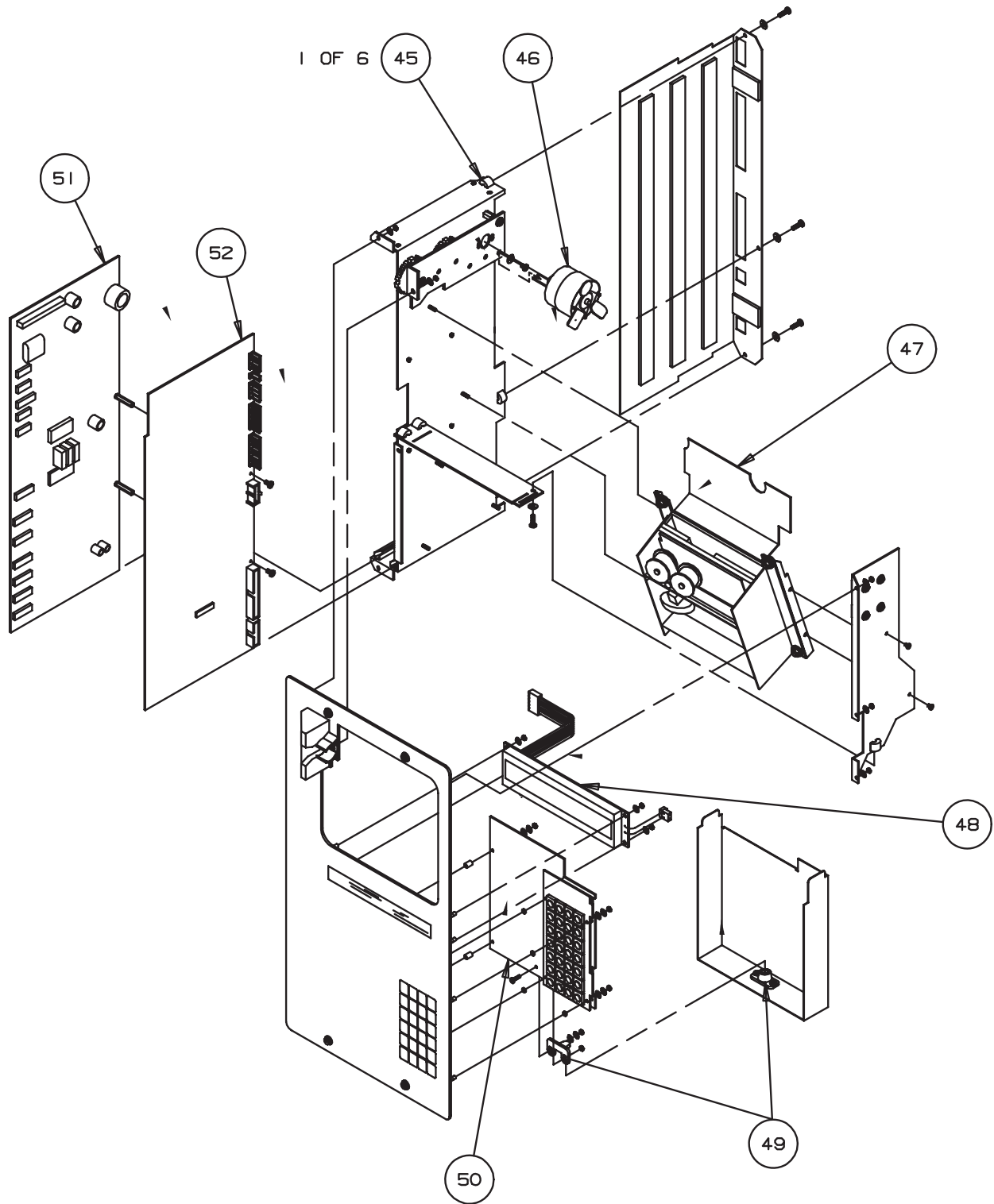

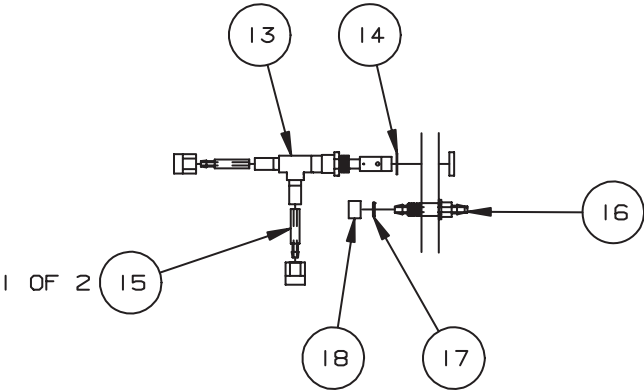

DETAIL A

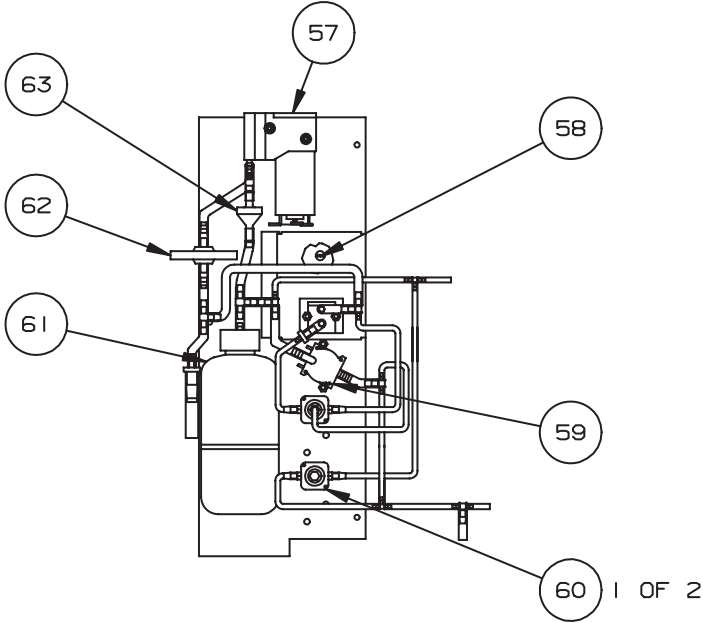

DRAWING NO: 60-3233-144
REVISION: F
SHEET 4 of 6
EFFECTIVE DATE: 05196

REPLACEMENT PARTS LIST

ITEM NUMBER	PART NUMBER	DESCRIPTION
1	60-1704-017	CARRYING HANDLE ASSEMBLY
2	60-3213-255	WALL MOUNT
3	109-0605-01	DRAW LATCH ASSEMBLY, SMALL
4	60-3233-139	EXTERNAL DESICCANT TUBE
5	231-0197-04	SELF SEALING SCREW 10-32 X ¼
6	60-3213-310	CONNECTOR PROTECTOR CAP, SMALL
7	60-3213-308	CONNECTOR CAP GASKET, SMALL
8	60-3113-024	CONNECTOR PROTECTOR CAP, MEDIUM
9	60-3113-032	CONNECTOR CAP GASKET, MEDIUM
10	60-3213-311	CONNECTOR PROTECTOR CAP, LARGE
11	60-3213-309	CONNECTOR CAP GASKET, LARGE
12	60-9003-291	CONNECTOR CAP STRAP
13	209-0090-07	METERING VALVE
14	60-3233-033	BUBBLE RATE ADJUSTMENT VALVE GASKET
15	60-3233-021	HOSE BARB
16	60-3233-014	AIR FITTING
17	202-1000-10	O RING .240 ID X .070 CROSS SECTION
18	60-3233-015	FITTING NUT
19	60-3233-121	CONNECTOR LABEL
20	60-3234-067	CASE BOTTOM SUB ASSEMBLY, GRAY
21	099-0012-00	DESICCANT DRI-CAN CANNISTER
22	60-3233-106	DESICCANT CAN HOLDER
23	60-3213-060	PRINTER LABEL
24	60-3213-261	DOOR GASKET
25	60-3214-141	CASE LATCH ASSEMBLY
26	60-3113-034	LATCH PIN
27	66-4230-006	REPLACEMENT LID
28	60-3213-259	WINDOW
29	60-3213-260	4200 CASE LID GASKET

Notes:

1. For current prices and quotations on parts, contact the Isco Customer Service Department.
2. This list is subject to change without notice.

DRAWING NO: 60-3233-144
 REVISION: F
 SHEET 5 of 6
 EFFECTIVE DATE: 05196

REPLACEMENT PARTS LIST

ITEM NUMBER	PART NUMBER	DESCRIPTION
30	60-3233-099	HINGE PIN
31	60-9004-282	DESICCANT CARTRIDGE ASSEMBLY
32	142-2004-00	SPRING CLIP
33	60-3214-120	12VDC/SAMPLER WIRING ASSEMBLY
34	202-4001-14	O RING .612 ID X .103 CROSS SECTION
35	202-4001-18	O RING .862 ID X .103 CROSS SECTION
36	60-3214-140	RAIN GAUGE WIRING ASSEMBLY
37	60-3214-122	INTERROGATOR WIRING ASSEMBLY
38	60-9003-031	CONNECTOR HOLE PLUG
39	60-3214-125	PARAMETER WIRING ASSEMBLY
40	202-4001-20	O RING .987 ID X .103 CROSS SECTION
41	60-3234-022	SUPPLY SPOOL ASSEMBLY
42	60-3213-229	SPOOL END CAP
43	60-3234-023	REROLL SPOOL ASSEMBLY
44	60-2313-005	PRINTER PAPER CORE
45	239-0416-32	SHEET EDGE FASTENER, 6-32
46	60-3214-139	CHART DRIVE MOTOR ASSEMBLY
47	60-3214-159	PRINTER SUB ASSEMBLY
48	60-3214-093	BACKLIT LCD MODULE ASSEMBLY
49	109-0609-00	CABINET CATCH, WHITE
50	60-3214-098	CIRCUIT BOARD ASSEMBLY, KEYBOARD
51	60-3234-052	CIRCUIT BOARD ASSEMBLY, 4230 AMPLIFIER
52	60-3239-002	KIT, 4230 CPU REPLACEMENT
53	60-3223-009	BULKHEAD NUT
54	202-1000-14	O RING .489 ID X .070 CROSS SECTION
55	60-3223-010	BULKHEAD FITTING
56	209-0166-65	ELBOW, 1/8 NPT TO 1/4" ID, NYLON
57	306-1000-00	MICRO-DIAPHRAGM PUMP, 12VDC
58	60-3234-060	CIRCUIT BOARD ASSEMBLY, 4230 SENSOR

Notes:

1. For current prices and quotations on parts, contact the Isco Customer Service Department.
2. This list is subject to change without notice.

A.2 Accessories

The following section lists optional equipment and accessories for the 4230 flow meter.

Model 4230 Basic Unit, 68-4230-001*Includes:*

Bubble Line $\frac{1}{16}$ " ID \times 25' Teflon.....	60-1873-051
Stainless Steel Bubble Tube	60-1704-018
4230 Flow Meter	60-3234-048
Accessory Package	60-3234-050
Instruction Manual	60-3234-051
Pocket Guide	60-3233-102
Caution Tag	60-3003-256
Dri-Can Desiccant	099-0012-00
Flow Data Handbook.....	60-3003-041

Basic Unit with Vinyl Bubble Line, 68-4230-002*Includes:*

Bubble Line $\frac{1}{8}$ " ID \times 50' Vinyl.....	60-1873-044
Stainless Steel Bubble Tube	60-1873-043
4230 Flow Meter	60-3234-048
4230 Flow Meter Only.....	60-3234-049

4230 Accessories

4230 Flow Meter Instruction Manual	60-3234-051
4230 Flow Meter Pocket Guide.....	60-3233-102
Bubble Line, $\frac{1}{16}$ " ID \times 25' Teflon.....	60-1873-051
Bubble Line, $\frac{1}{8}$ " ID \times 50' Vinyl.....	60-1873-044
Bubble Line, $\frac{1}{8}$ " ID \times 100' Vinyl.....	68-1700-003
4' Stainless Steel Bubble Tubes (attach to bubble line outlet)	
(For use with the $\frac{1}{16}$ " ID Teflon Bubble Line).....	60-1704-018
(For use with the $\frac{1}{8}$ " ID Vinyl Bubble Line).....	60-1873-043
Supplemental Desiccant Cartridge	60-3244-059
Reference Port Tubing 10' \times $\frac{1}{4}$ " ID Vinyl.....	60-2703-111
Reference Port Tubing 25' \times $\frac{1}{4}$ " ID Vinyl.....	60-2703-112
Bubbler Tube Retainer Assembly (includes carrier and stainless bubble outlet)	
(Allows installation in round pipes with Isco Mounting Rings, $\frac{1}{8}$ " ID Vinyl only)...	60-3204-007
6" Flow Metering Insert with Pump and Poles (handle extensions)	68-3230-005
8" Flow Metering Insert with Pump and Poles.....	68-3230-006
10" Flow Metering Insert with Pump and Poles.....	68-3230-007
12" Flow Metering Insert with Pump and Poles.....	68-3230-008
6" Flow Metering Insert	60-3234-031
8" Flow Metering Insert	60-3234-032
10" Flow Metering Insert	60-3234-033

12" Flow Metering Insert	60-3234-034
Flow Metering Insert Pump Assembly.....	60-3234-024
Pole Section Assembly.....	60-2814-046
Flow Poke Pump Conversion Package.....	60-3234-043
Flow Poke Insert Conversion Package	68-3230-011
Flow Metering Insert Instruction Manual.....	60-3234-064

Other

High-Low Alarm Relay Box	60-3404-028
4-20 mA Output Interface.....	60-1784-039
674 Rain Gauge (0.01")	60-3284-001
Chart Roller	60-3004-156
Spreader Bar.....	60-3004-110
pH Probe and 201 pH Module (25 ft. cable standard) (<i>Includes probe, built-in temperature sensor</i>)	68-4200-002
pH Probe only	60-9004-126
D.O. Probe only	472-0000-00
D.O. Membrane Kit (<i>Includes 30, 0.002" membranes, electrolyte, sanding tool and disks</i>)	479-0020-02
O-Ring Kit for D. O. Probe	479-0020-00
Temperature Probe only.....	60-3214-130
Isco Sampler to Flow Meter Connect Cable - 25 ft.	60-3004-107
External 12VDC Source Connect Cable- 6 ft.	60-1394-023
YSI 600 Sonde with pH, D.O., conductivity, temperature sensors, and 25 ft. cable	68-0600-111

Note: Item 68-0600-111 includes a YSI-to-Isco 4200/6700 adapter cable, calibration/transport cup, 1# stainless steel nose weight, and YSI instruction manual. **Many other** configurations of the YSI 600 Sonde are available **without** either the pH and/or D.O. sensors, or supplied with 50, 100, or 200 ft. cables. Also available is a **low ionic strength pH sensor** for use in streams with very low conductivity (10µS/cm or less). Call the factory for more information.

YSI 600 Accessories

D.O. Sensor Maintenance Supplies

D.O. Probe membrane and electrolyte kit (30 membranes, 30 mL KCl soln., 2 O-rings).....	60-0603-205
D.O. Probe reconditioning kit (Instructions and sanding disks).....	60-0603-206

Calibration Solutions – Conductivity Sensor – 1 Quart

1 mS/cm.....	60-0603-207
10 mS/cm.....	60-0603-208
100 mS/cm.....	60-0603-209

Calibration Solutions – Boxes of 8, 1-Pint Containers

1 mS/cm.....	60-0603-210
10 mS/cm.....	60-0603-211
50 mS/cm.....	60-0603-212

Miscellaneous – for use with the YSI Sonde

Calibration/Transport Bottle Kit.....	60-0603-216
Carrying Case for YSI 600, cables, accessories, tools.....	60-0603-217
YSI 600 Instruction Manual.....	60-0603-218
YSI 600 to Isco 4200/6700 Adapter Cable.....	60-0604-001
YSI 600 and Isco 674 Rain Gauge Y-Connect Cable.....	60-0604-002

(This cable allows use of the YSI 600 Sonde and the Isco 674 Rain Gauge at the same time.)

Use the following with Isco Mounting Rings in Round Pipe Installations

Probe Carrier for Temperature probe.....	60-3204-010
Probe Carrier for pH probe with internal temperature sensor.....	60-3208-001
Probe Carrier for D.O. probe and separate Temperature probe.....	60-3204-006

Spring Rings

Probe Mounting Ring for 6" pipe.....	60-3200-007
Probe Mounting Ring for 8" pipe.....	60-3200-008
Probe Mounting Ring for 10" pipe.....	60-3200-009
Probe Mounting Ring for 12" pipe.....	60-3200-010
Probe Mounting Ring for 15" pipe.....	60-3200-011

Scissors Ring

(for Pipes 16" diameter and larger)

Base Section (with tabs for mounting up to five probes).....	60-3004-171
Scissors Assembly.....	60-3004-170
Extension 1 (9.0").....	60-3004-172
Extension 2 (21.5").....	60-3004-173
Extension 3 (31.5").....	60-3004-174
Extension 4 (41.5").....	60-3004-175

Note that Scissors Ring Assemblies will require a base and scissors section for all sizes. Sizes from 21" to 80" will also require two or more extension sections.

4230 Flow Meter

Appendix B Programming Worksheets

Use this form to make a hard copy of the program you use in your 4230. Most program steps can be completed in the shop without the flow meter being installed or at the job site. However, please note the following:

- Do not attempt to fill out this sheet without first studying the manual, especially Section 2 Programming. This section describes the program in detail and offers reasons you might choose one option over another. This is particularly so for those using the flow meter for the first time. Keep this chart as a record. For steps where a space is not provided on the sheet, underline or circle your choices.
- Some of the menus shown on this sheet may not appear on your flow meter. The reason is that you must make choices from the first step forward that will prevent you from choosing other options later on. Options can appear at several points of the program. However, menus pertaining to the options not chosen early on will not appear later. An example is the alarm dial-out feature. This step requires your flow meter to have the optional modem. If you do not have the modem, no menus concerning dialout will appear.
- If, after filling out this chart, you cannot make some menus appear that you need, recheck your early steps to see that you have not accidentally locked yourself out of a path by an incorrect early selection.
- If you only need to program the flow meter once, you can write on this sheet. If you are doing temporary surveys, or expect the program to change, make copies of these sheets and write on the copies.

B.1 Setup

1. Select Option: Program, Setup. *First, choose Setup and work through the following menus.*
2. Year/ Month/ Day/ Hour/ Min _____
3. Site I.D. _____ (*Any three-digit number*)
4. Measurement Setup: Level Reading Interval, Minimum Depth, D.O./pH Reading Interval
5. Purge Interval: 5 min, 10 Min, 15 Min, 30 Min, 1 Hour _____
6. Super Bubble Mode: On, Off _____
7. D.O./ph Reading Interval: Continuous, 15 Sec, 30 Sec, 1Min, 2 Min, 5 Min

8. YSI 600 Reading Interval: Continuous, 15 Sec, 30 Sec, 1Min, 2 Min, 5 Min
9. Level Enable/Alarm: Hysteresis _____ Feet (Or Meters)
10. Flow Rate Enable/Alarm Hysteresis _____ Units _____
11. Temperature Enable/Alarm Hysteresis _____ Deg. F (C)
12. pH Enable/Alarm Hysteresis _____ pH units.
13. D.O. Enable/Alarm Hysteresis _____ ppm.
14. YSI-pH Enable/Alarm Hysteresis _____ pH units.
15. YSI-D.O. Enable/Alarm Hysteresis _____ ppm/mg./L
16. YSI-Conductivity Enable /Alarm Hysteresis _____ mS/cm
17. YSI-Temperature Enable/Alarm Hysteresis _____ Deg.
18. Optional Outputs: 4-20 Ma Output, Serial Output, Alarm Box, Mechanical Totalizer
19. Report Setup, Report A: Flow, D.O./pH, YSI 600, Sample History, Flow Meter History
20. Level In Report: Yes, No
21. Flow Rate In Report: Yes, No
22. Rainfall In Report: Yes, No
23. pH or D.O. In Report: Yes, No
24. Temperature In Report: Yes, No
25. YSI 600 Data in Report: Yes, No
26. Sample History In Report: Yes, No
27. Flow Meter History In Report: Yes, No
28. Report Setup, Report B: Flow, D.O./pH, YSI 600, Sample History, Flow Meter History
29. Level In Report: Yes, No
30. Flow Rate In Report: Yes, No
31. Rainfall In Report: Yes, No
32. pH or D.O. In Report: Yes, No
33. Temperature In Report: Yes, No
34. YSI 600 Data in Report: Yes, No
35. Sample History In Report: Yes, No
36. Setup Options: Status, Report Setup, LCD Backlight
37. LCD Backlight Mode: Time-out, Continuous, Off
38. Language: English, French, German, Spanish
39. Program Lock: On, Off
40. Select Option: Program, Setup. *This time, select Program and do the following* (Program Section)
41. Units Of Level Measure: Ft., In, M, mm, Not Measured
42. Flow Rate Units of Measure: GPS, GPM, GPH, MGD, CFS, CFM, CFH, CFD, LPS, M3S, M3M, M3H, M3D, AFD
43. Totalized Volume Units: GAL, MGAL, CF, L, M3, AF

44. Rain Gauge: Inches, MM, Not Measured
45. pH Units Of Measure: pH, Not Measured
46. D. O. Units: MG/L, PPM, Not Measured
47. Temperature Units: Deg F, Deg. C, (Not Measured)
48. YSI-pH Units Of Measure: pH, Not Measured
49. YSI-D.O. Units: MG/L, PPM, Not Measured
50. YSI-Conductivity Parameter: Specific Conductivity, Salinity, Conductivity, T.D. S.
_____Units_____Coeff._____
51. YSI-Temperature: Deg F, Deg. C, (Not Measured)

B.2 Flow Conversion: Level-to-Flow Rate

1. Flow Conversion Type: Weir/flume, Equation, Manning, Data Points,
2. Type Of Device: Weir, Flume
3. Select Type Of Weir: V-notch, Rectangular, Cipolletti
4. Select V-notch Weir Angle (In Degrees): 22.5, 30, 45, 60, 90, 120,
5. End Contractions On Rectangular Weir: Yes, No
6. Rect. Weir With End Contractions: Enter Crest Length
_____ Feet (or meters)
7. Cipolletti Weir: Enter Crest Length_____ Feet (or meters)
8. Type Of Flume: Palmer-Bowlus, Parshall, Trapezoidal, H, HS, HL, Leopold-Lagco
9. Palmer-Bowlus Size: 4", 6", 8", 9", 10", 12", 15", 18", 21", 24", 27", 30", 48"
10. Parshall Size: 1", 2", 3", 6", 9", 1.0', 1.5', 2.0', 3', 4', 5', 6', 8', 10', 12"
11. Trapez. Size: LG 60 V, 2" 45 WSC, 45 SRCRC, XL 60
12. Flume Size: .5', .75', 1', 2', 2.5' 3', 4.5'
13. HS Flume Size: 0.4', 0.5', 0.6', 0.8', 1.0
14. HL Flume Size: 2.0', 2.5', 3.0', 3.5', 4.0
15. Leopold-Lagco Flume Size: 4", 6", 8", 10", 12", 15", 18", 21", 24", 30"
16. Enter Equation Units: $Q = \text{_____} H^{\text{_____}} + \text{_____} H^{\text{_____}}$
($Q = kH^{P1} + kH^{P2}$)
(Note that if your equation does not have a second term, (kH^{P2}), just enter 0 (zero) for it.)
17. Manning Types: Round Pipe, U-channel, Rectangular, Trapezoid
18. Mann. Round Pipe: Slope = _____ Rough = _____
19. Mann. Round Pipe: Diameter = _____ Feet (or meters)
20. Mann. U-channel: Slope = _____ Rough = _____
21. Mann. U-channel: Width = _____ Feet (or meters)

B.3 Parameter to Adjust

1. Parameter To Adjust: None, Level, pH, D.O., YSI 600
2. (Job Site only) Enter Current Level: ____ Ft (or M).
Note: Installations generally use either the Teledyne Isco parameter probes or the YSI 600 Sonde, but not both. Use the following menus for either the Teledyne Isco probes or the YSI 600 Sonde. Steps 3, 4, and 5 can be used for both 2 and 3-point pH calibrations.
3. Rinse Probe And Place In 4.0 pH Solution: Press Enter When Stable ____ pH (job site only)
4. Rinse Probe And Place In 7.0 pH Solution: Press Enter When Stable ____ pH (job site only)
5. Rinse Probe And Place In 10.0 pH Solution: Press Enter When Stable ____ pH (job site only)
6. (YSI 600 D.O. Calibration only): D.O. Standard, Absolute Barometric Pressure, Altitude
7. Altitude Units Of Measure: Ft., M (D.O. probe only)____ (job site only)
8. (D.O. only) Enter Altitude: Altitude = _____ Feet (or meters, at job site only)
9. Wrap D.O. Probe In Moist Cloth: Press Enter When Stable: ____ MG/L (at job site only)
10. Conductivity Calibration Units: Ms/cm, Ppt _____
11. Place Probe In _____ Ms/cm. (or ppt) Press Enter When Stable: _____ Ms/cm (at job site only)
12. YSI 600 Dissolved Oxygen Calibration: D.O. Standard, Absolute Barometric Pressure, Altitude

B.4 Reset Totalizer

1. Reset Totalizer: Yes, No
2. Enable Totalizer _____ CF (or other units) _____
3. Reset Sampler Enable Totalizer: Yes, No

B.5 Sampler Pacing

1. Sampler Pacing: Disable, (Volume), (Flowlink), Conditional
2. Sampler Pacing: Enter Pacing Volume ____ CF
3. Condition: Level, Flow Rate, Rainfall, D.O., pH, Temperature, YSI pH, YSI D.O., YSI Conductivity, YSI Temperature
4. Condition: Greater Than, Less Than, Rate Of Change
5. Select Operator: Done, Or, And
6. Condition True Pacing Interval: Pace Every ____ Minutes.
7. Condition False Pacing Interval: Pace Every ____ Minutes.

B.6 Sampler Enable

1. Sampler Enable Mode: Disable, Enable, Conditional, (Storm), (Flowlink)
2. Level: Greater Than ____ Feet (or meters)
3. Rainfall Amount: ____ Inches (other units)

4. Rainfall Time Period: 15 Min, 30 Min, 1 Hr, 2 Hr, 4 Hr, 6 Hr, 8 Hr, 12 Hr, 24 Hr, 48 Hr, 72 Hr
5. Time Since Last Rainfall: Days: _____ (enter 1 to 7)
6. Condition: Level, Flow Rate, D.O., pH, Temperature, Rainfall, YSI pH, YSI D.O., YSI Conductivity, YSI Temperature
7. Level: Greater Than, Less Than, Rate Of Change
8. Level: Greater Than ____ Feet (or meters)
9. Select Operator: Done, Or, And
10. Flow Rate: Greater Than, Less Than, Rate Of Change
11. When Enable Condition Is No Longer Met: Disable Sampler, Keep Enabled
12. Enable Currently Latched, Reset: No, Yes
13. Printer On/off With Enable: Yes, No

B.7 Alarm Dialout Mode

You must have a modem installed in the flow meter for any of these menus to appear.

1. Alarm Dialout: Disable, Conditional, Storm, Flowlink
2. Level: Greater Than ____ Feet.
3. Rainfall Amount: ____ Inches (other units)
4. Rainfall Time Period: 15 Min, 30 Min, 1 Hr, 2 Hr, 4 Hr, 6 Hr, 8 Hr, 12 Hr, 24 Hr, 48 Hr, 72 Hr
5. Time Since Last Rainfall: Days: _____ (allowable 1-7)
6. Condition: Level, Flow Rate, D.O., pH, Temperature, Rainfall, YSI pH, YSI DO, YSI Conductivity, YSI Temperature
7. Condition: Greater Than, Less Than, Rate Of Change
8. Select Operator: Done, Or, And
9. Alarm Dial-out Numbers: Done, Num. 1, Num. 2, Num. 3, Num. 4, Num. 5
10. First Phone Number:
11. Second Phone Number:
12. Third Phone Number:
13. Fourth Phone Number:
14. Fifth Phone Number:
15. Delay Between Dialouts: _____ Minutes
16. Callback To Disable Alarm: Yes, No

B.8 Printer

1. Enter Printer Speed: Off, 1/2"/hr, 1"/hr, 2"/hr, 4"/hr
2. Input For Printer Line A: None, Level, Flow Rate, pH, D.O., Temp, YSI pH, YSI D.O., YSI Cond., YSI Temp.
3. Printer Line A Bottom Scale: ____ pH
4. Printer Line A Full Scale: ____ Feet (or meters)
5. Input For Printer Line B: None, Level, Flow Rate, pH, D.O., Temp, YSI pH, YSI D.O., YSI Cond., YSI Temp.

6. Input For Printer Line C: None, Level, Flow Rate, pH, D.O., Temp, YSI pH, YSI D.O., YSI Cond., YSI Temp.
7. Plot Rainfall On Chart?: No, Yes

B.9 Reports/History

1. Report Generator A: On, Off, (Print)
2. Report A Duration To Be In: Hours, Days, Months
3. Enter Report A Duration: _____ Hours
4. Print Report A at Yr: _____ Month: ___ Day: ___ Hr: ___
Min: ___
5. Report Generator B: On, Off, (Print)
6. Report B Duration To Be In: Hours, Days, Months
7. Enter Report B Duration: _____ Hours
8. Print Report B at Yr: _____ Month: ___ Day: ___ Hr: ___
Min: ___
9. Print Flow Meter History: Yes, No
10. Print Flow Meter History: Print Since Last, Print All

NOTES

4230 Flow Meter

Appendix C General Safety Procedures

In field installations of 4230 Flow Meters and associated equipment, the safety of the personnel involved should be the foremost consideration. The following sections provide safety procedures for working in and around manholes and sewers. The first section offers general safety advice. The second section deals with the special problem of hazardous gases found in sewers.

WARNING

The 4220 Flow Meter has not been approved for use in hazardous locations as defined by the National Electrical Code.

CAUTION

Before any flow meter is installed, the proper safety precautions must be taken. The following discussions of safety procedures are only general guidelines. Each situation in which you install a flow meter varies. You must take into account the individual circumstances you are in. Additional safety considerations, other than those discussed here, may be required.

C.1 Practical Safety Precautions

The following procedures are those used by Black & Veatch, a respected consulting firm, and are published here by permission.

“Field personnel must keep safety uppermost in their minds at all times. When working above ground, rules of common sense and safety prevail. However, when entering manholes, strict safety procedures must be observed. Failure to do so could jeopardize not only your own life, but also the lives of other crew members.

“1. **Hazards.** There are many hazards connected with entering manholes. Some of the most common hazards are:

“**Adverse Atmosphere.** The manhole may contain flammable or poisonous gases or the atmosphere may be deficient in oxygen. Forced ventilation may be necessary.

“**Deteriorated Rungs.** Manhole steps may be corroded and not strong enough to support a man. It may be difficult to inspect the rungs because of poor lighting.

“**Traffic.** Whenever manholes are located in the traveled way, barricades and warning devices are essential to direct traffic away from an open manhole.

“**Falling Object.** Items placed near the manhole opening may fall and injure a worker in the manhole.

“**Sharp Edges.** Sharp edges of items in or near a manhole may cause cuts or bruises.

“Lifting Injuries. Unless proper tools are used to remove manhole covers, back injuries or injuries to hands or feet may result.

“2. Planning. Advance planning should include arrangements for test equipment, tools, ventilating equipment, protective clothing, traffic warning devices, ladders, safety harness, and adequate number of personnel. Hasty actions may result in serious injuries. Time spent in the manhole should be kept to a minimum.

“3. Adverse Atmosphere. [Refer to Table C-1, Hazardous Gases, at the end of this appendix.] Before workers enter a manhole, tests should be made for explosive atmosphere, presence of hydrogen sulfide, and oxygen deficiency. Combustible or toxic vapors may be heavier than air, so the tests on the atmosphere must be run at least $\frac{3}{4}$ of the way down the manhole.

“Whenever adverse atmosphere is encountered, forced ventilation must be used to create safe conditions. After the ventilating equipment has been operated for a few minutes, the atmosphere in the manhole should be retested before anyone enters the manhole.

“When explosive conditions are encountered, the ventilating blower should be placed upwind to prevent igniting any gas that is emerging from the opening. When a gasoline engine blower is used, it must be located so that exhaust fumes cannot enter the manhole.

“If testing equipment is not available, the manhole should be assumed to contain an unsafe atmosphere and forced ventilation must be provided. It should never be assumed that a manhole is safe just because there is no odor or the manhole has been entered previously.

“4. Entering Manholes. Since the top of the manhole is usually flush with the surrounding surface, there may not be anything for the person who is entering the manhole to grab on to steady himself. Persons who are entering manholes should not be permitted to carry anything in their hands as they enter the manhole, to ensure that their hands will be free to hold on or grab if they slip. A good method for entering a manhole is to sit on the surface facing the manhole steps or ladder, with the feet in the hole and the arms straddling the opening for support. As the body slides forward and downward, the feet can engage a rung, and the back can rest against the opposite side of the opening. If there is any doubt about the soundness of the manhole steps, a portable ladder should be used.

“A person should never enter a manhole unless he is wearing personal safety equipment, including a safety harness and a hard hat. Two persons should be stationed at the surface continuously while anyone is working inside a manhole, to lift him out if he is overcome or injured. One man cannot lift an unconscious man out of a manhole. The persons stationed at the surface should also function as guards to keep people and vehicles away from

the manhole opening. To avoid a serious injury, a person should not be lifted out of a manhole by his arm unless it is a dire emergency.

“When more than one person must enter a manhole, the first person should reach the bottom and step off the ladder before the next one starts down. When two men climb at the same time, the upper one can cause the lower one to fall by slipping or stepping on his fingers.

“5. **Traffic Protection.** In addition to traffic cones, markers, warning signs, and barricades, a vehicle or a heavy piece of equipment should be placed between the working area and oncoming traffic. Flashing warning signals should be used to alert drivers and pedestrians. Orange safety vests should be worn by personnel stationed at the surface when the manhole is located in a vehicular traffic area.

“6. **Falling Object.** All loose items should be kept away from the manhole opening. This applies to hand tools as well as stones, gravel and other objects.

“7. **Removing the Covers.** Manhole covers should be removed with a properly designed hook. Use of a pick ax, screwdriver, or small pry bar may result in injury. A suitable tool can be made from $\frac{3}{4}$ -inch round or hex stock. Two inches of one end should be bent at a right angle and the other end should be formed into a D-handle wide enough to accommodate both hands. Even with this tool, care must be exercised to prevent the cover from being dropped on the toes. The 2-inch projection should be inserted into one of the holes in the cover, the handle grasped with both hands, and the cover lifted by straightening the legs which have been slightly bent at the knees.

“8. **Other Precautions.** Other precautions which should be taken when entering a manhole are:

- Wear a hard hat.
- Wear coveralls or removable outer garment that can be readily removed when the work is completed.
- Wear boots or nonsparking safety shoes.
- Wear rubberized or waterproof gloves.
- Wear a safety harness with a stout rope attached.
- Do not smoke.
- Avoid touching yourself above the collar until you have cleaned your hands.

“9. **Emergencies.** Every member of the crew should be instructed on procedures to be followed in cases of an emergency. It is the duty of each crew chief to have a list of emergency phone numbers, including the nearest hospital and ambulance service, police precinct, fire station, and rescue or general emergency number.

“10. **Field Equipment.** The following equipment will be available for use:

Blowers	Gloves	Traffic cones
Breathing apparatus	Hard Hats	Coveralls
Harnesses	First aid kits	Manhole irons
Emergency flashers	Pick axes	Flashlights
Rain slickers	Mirrors	Ropes
Gas detectors	Safety vests	Gas masks
Waders”		

C.2 Lethal Atmospheres in Sewers

The following is an article written by Dr. Richard D. Pomeroy, and published in the October 1980 issue of *Deeds & Data* of the WPCF. Dr. Pomeroy is particularly well known for his studies, over a period of nearly 50 years, in the field of the control of hydrogen sulfide and other odors in sewers and treatment plants. He has personally worked in a great many functioning sewers. In the earlier years he did so, he admits, with little knowledge of the grave hazards to which he exposed himself.

“It is gratifying that the subject of hazards to people working in sewers is receiving much more attention than in past years, and good safety procedures are prescribed in various publications on this subject. It is essential that people know and use correct procedures.

“It is less important to know just what the hazardous components of sewer atmospheres are, as safety precautions should in general be broadly applicable, but there should be a reasonable understanding of this subject. It is disturbing to see statements in print that do not reflect true conditions.

“One of the most common errors is the assumption that people have died from a lack of oxygen. The human body is able to function very well with substantially reduced oxygen concentrations. No one worries about going to Santa Fe, New Mexico, (elev. 2,100 meters), where the partial pressure of oxygen is equal to 16.2% (a normal atmosphere is about 21%) oxygen. When first going there, a person may experience a little ‘shortness of breath’ following exercise. People in good health are not afraid to drive over the high passes in the Rocky Mountains. At Loveland Pass, oxygen pressure is 13.2% of a normal atmosphere. At the top of Mt. Whitney, oxygen is equal to 12.2%. Many hikers go there, and to higher peaks as well. After adequate acclimation, they may climb to the top of Mt. Everest, where oxygen is equal to only 6.7%.

“The lowest oxygen concentrations that I have observed in a sewer atmosphere was 13 percent. It was in a sealed chamber, near sea level, upstream from an inverted siphon on a metropolitan trunk. A man would be foolish to enter the chamber. Without ventilation, he might die, but not from lack of oxygen.

“It seems unlikely that anyone has ever died in a sewer from suffocation, that is, a lack of oxygen. Deaths have often been attributed to ‘asphyxiation.’ This is a word which, according to the dictionary, is used to mean death from an atmosphere that does not support life. The word has sometimes been misinterpreted as meaning suffocation, which is only one kind of asphyxiation.

“In nearly all cases of death in sewers, the real killer is hydrogen sulfide. It is important that this fact be recognized. Many cities diligently test for explosive gases, which is very important, and they may measure the oxygen concentration which usually is unimportant, but they rarely measure H₂S. Death has occurred where it is unlikely that there was any measurable reduction in the oxygen concentration. Waste water containing 2 mg per liter of dissolved sulfide, and at a pH of 7.0, can produce, in a chamber with high turbulence, a concentration of 300 PPM H₂S, in the air. This is considered to be a lethal concentration. Many people have died from H₂S, not only in sewers and industries, but also from swamps and from hot springs. In one resort area, at least five persons died from H₂S poisoning before the people were ready to admit that H₂S is not a therapeutic agent. Hardly a year passes in the U.S. without a sewer fatality from H₂S as well as deaths elsewhere in the world.

“The presence of H₂S in a sewer atmosphere is easily determined. A bellows-and-ampoule type of tester is very satisfactory for the purpose, even though it is only crudely quantitative. When using a tester of this type, do not bring the air to the ampoule by way of a tube, as this may change the H₂S concentration. Hang the ampoule in the air to be tested, with a suction tube to the bulb or bellows.

“Lead acetate paper is very useful as a qualitative indicator. It cannot be used to estimate the amount of sulfide, but it will quickly turn black in an atmosphere containing only a tenth of a lethal concentration.

“Electrodes or other similar electrical indicating devices for H₂S in air have been marketed. Some of them are known to be unreliable, and we know of none that have proved dependable. Do not use one unless you check it at frequent intervals against air containing known H₂S concentrations. A supposed safety device that is unreliable is worse than none at all.

“Remember that the nose fails, too, when it comes to sensing dangerous concentrations of H₂S.

“Various other toxic gases have been mentioned in some publications. It is unlikely that any person has been asphyxiated in a sewer by any of those other gases, except possibly chlorine. The vapor of gasoline and other hydrocarbons is sometimes present in amounts that could cause discomfort and illness, but under that condition, the explosion hazard would be far more serious. The explosimeter tests, as well as the sense of smell, would warn of the danger. Pipelines in chemical plants might contain any

number of harmful vapors. They, too, are sensed by smell and explosimeter tests if they get into the public sewer. Such occurrences are rare.

“The attempt to instill a sense of urgency about real hazards is diluted if a man is told to give attention to a long list of things that in fact are irrelevant.

“Be very careful to avoid high H₂S concentrations, flammable atmospheres, and hazards of physical injuries. Remember that much H₂S may be released by the stirring up of sludge in the bottom of a structure. Obey your senses in respect to irritating gases, such as chlorine (unconsciousness comes suddenly from breathing too much). Be cautious about strange odors. Do not determine percent oxygen in the air. There is a danger that the result will influence a man's thinking about the seriousness of the real hazards. Most important, use ample ventilation, and do not enter a potentially hazardous structure except in a good safety harness with two men at the top who can lift you out.”

C.3 Hazardous Gases

The following table contains information on the properties of hazardous gases.

Table C-1 Hazardous Gases										
Gas	Chemical Formula	Common Properties	Specific Gravity or Vapor Density Air =1	Physiological Effect	Max Safe 60 Min. Exposure ppm	Max. Safe 8 Hour Exposure ppm	Explosive Range (% by vol. in air) Limits lower/upper	Likely Location of Highest Concentration	Most Common Sources	Simplest and Cheapest Safe Method of Testing
Ammonia	NH ₃	Irritant and poisonous. Colorless with characteristic odor.	0.60	Causes throat and eye irritation at 0.05%, coughing at 0.17%. Short exposure at 0.5% to 1% fatal.	300 to 500	85	16 25	Near top. Concentrates in closed upper spaces	Sewers, chemical feed rooms.	Detectable odor at low concentrations
Benzene	C ₆ H ₆	Irritant, colorless anesthetic	2.77	Slight symptoms after several hours exposure at 0.16% to 0.32%. 2% rapidly fatal.	3,000 to 5,000	25	1.3 7.1	At bottom.	Industrial wastes, varnish, solvents.	Combustible gas indicator
Carbon Bisulfide	CS ₂	Nearly odorless when pure, colorless, anesthetic. Poisonous.	2.64	Very poisonous, irritating, vomiting, convulsions, psychic disturbance.	—	15	1.3 44.0	At bottom	An insecticide	Combustible gas indicator

Table C-1 Hazardous Gases (Continued)

Gas	Chemical Formula	Common Properties	Specific Gravity or Vapor Density Air =1	Physiological Effect	Max Safe 60 Min. Exposure ppm	Max. Safe 8 Hour Exposure ppm	Explosive Range (% by vol. in air) Limits lower/upper	Likely Location of Highest Concentration	Most Common Sources	Simplest and Cheapest Safe Method of Testing
Carbon Dioxide	CO ₂	Asphyxiant, Colorless, odorless. When breathed in large quantities, may cause acid taste. Non-flammable. Not generally present in dangerous amounts unless an oxygen deficiency exists.	1.53	Cannot be endured at 10% more than a few minutes, even if subject is at rest and oxygen content is normal. Acts on respiratory nerves.	40,000 to 60,000	5,000	— —	At bottom; when heated may stratify at points above bottom.	Products of combustion, sewer gas, sludge. Also issues from carbonaceous strata.	Oxygen deficiency indicator
Carbon Monoxide	CO	Chemical asphyxiant. Colorless, odorless, tasteless. Flammable. Poisonous.	0.97	Combines with hemoglobin of blood. Unconsciousness in 30 min. at 0.2% to 0.25%. Fatal in 4 hours at 0.1%. Headache in few hours at 0.02%.	400	50	12.5 74.0	Near top, especially if present with illuminating gas.	Manufactured gas, flue gas, products of combustion, motor exhausts. Fires of almost any kind.	CO ampoules.
Carbon Tetra-Chloride	CCl ₄	Heavy, ethereal odor.	5.3	Intestinal upset, loss of consciousness, possible renal damage, respiratory failure.	1,000 to 1,500	100	— —	At bottom.	Industrial wastes, solvent, cleaning	Detectable odor at low concentrations.
Chlorine	Cl ₂	Irritant. Yellow-green color. Choking odor detectable in very low concentrations. Non-flammable.	2.49	Irritates respiratory tract. Kills most animals in a very short time at 0.1%.	4	1	— —	At bottom.	Chlorine cylinder and feed line leaks.	Detectable odor at low concentrations.
Formaldehyde	CH ₂ O	Colorless, pungent suffocating odor.	1.07	Irritating to the nose.	—	10	7.0 73.0	Near bottom.	Incomplete combustion of organics. Common air pollutant, fungicide.	Detectable odor.
Gasoline	C ₅ H ₁₂ to C ₉ H ₂₀	Volatile solvent. Colorless. Odor noticeable at 0.03%. Flammable.	3.0 to 4.0	Anesthetic effects when inhaled. Rapidly fatal at 2.4%. Dangerous for short exposure at 1.1 to 2.2%.	4,000 to 7,000	1,000	1.3 6.0	At bottom.	Service stations, garages, storage tanks, houses.	1. Combustible gas indicator. 2. Oxygen deficiency indicator.**
Hydrogen	H ₂	Simple asphyxiant. Colorless, odorless, tasteless. Flammable	0.07	Acts mechanically to deprive tissues of oxygen. Does not support life.	—	—	4.0 74.0	At top.	Manufactured gas, sludge digestion tank gas, electrolysis of water. Rarely from rock strata.	Combustible gas indicator.
Hydrogen Cyanide	HCN	Faint odor of bitter almonds. Colorless gas	0.93	Slight symptoms appear upon exposure to 0.002% to 0.004%. 0.3% rapidly fatal.	—	10	6.0 40.0	Near top.	Insecticide and rodenticide.	Detector tube

Table C-1 Hazardous Gases (Continued)

Gas	Chemical Formula	Common Properties	Specific Gravity or Vapor Density Air = 1	Physiological Effect	Max Safe 60 Min. Exposure ppm	Max. Safe 8 Hour Exposure ppm	Explosive Range (% by vol. in air) Limits lower/upper	Likely Location of Highest Concentration	Most Common Sources	Simplest and Cheapest Safe Method of Testing
Gas	Chemical Formula	Common Properties	Specific Gravity or Vapor Density Air = 1	Physiological Effect*	Max Safe 60 Min. Exposure ppm	Max. Safe 8 Hour Exposure ppm	Explosive Range (% by vol. in air.) Limits lower/upper	Likely Location of Highest Concentration	Most Common Sources	Simplest and Cheapest Safe Method of Testing
Hydrogen Sulfide	H ₂ S	Irritant and poisonous volatile compound. Rotten egg odor in small concentrations. Exposure for 2 to 15 min. at 0.01% impairs sense of smell. Odor not evident at high concentrations. Colorless. Flammable.	1.19	Impairs sense of smell, rapidly as concentration increases. Death in few minutes at 0.2%. Exposure to 0.07 to 0.1% rapidly causes acute poisoning. Paralyzes respiratory center.	200 to 300	20	4.3 to 45.0	Near bottom, but may be above bottom if air is heated and highly humid.	Coal gas, petroleum, sewer gas. Fumes from blasting under some conditions. Sludge gas.	1. H ₂ S Ampoule. 2. 5% by weight lead acetate solution.
Methane	CH ₄	Simple asphyxiant. Colorless, odorless, tasteless, flammable.	0.55	Acts mechanically to deprive tissues of oxygen. Does not support life.	Probably no limit, provided oxygen percent-age is sufficient for life.	—	5.0 15.0	At top, increasing to certain depth.	Natural gas, sludge gas, manufactured gas, sewer gas. Strata of sedimentary origin. In swamps or marshes.	1. Combustible gas indicator 2. Oxygen deficiency indicator.
Nitrogen	N ₂	Simple asphyxiant. Colorless, tasteless. Non-flammable. Principal constituent of air. (about 79%).	0.97	Physiologically inert.	—	—	— —	Near top, but may be found near bottom.	Sewer gas. sludge gas. Also issues from some rock strata.	Oxygen deficiency indicator.
Nitrogen Oxides	NO N ₂ O NO ₂	Colorless Colorless, sweet odor. Reddish-brown. Irritating odor. Deadly poison	1.04 1.53 1.58	60 to 150 ppm cause irritation and coughing. Asphyxiant. 100 ppm dangerous. 200 ppm fatal.	50	10	— —	Near bottom.	Industrial wastes. Common air pollutant.	NO ₂ detector tube.
Oxygen	O ₂	Colorless, odorless, tasteless. Supports combustion.	1.11	Normal air contains 20.8% of O ₂ . Man can tolerate down to 12%. Minimum safe 8 hour exposure, 14 to 16%. Below 10%, dangerous to life. Below 5 to 7% probably fatal.	—	—	— —	Variable at different levels.	Oxygen depletion from poor ventilation and absorption, or chemical consumption of oxygen.	Oxygen deficiency indicator.
Ozone	O ₃	Irritant and poisonous. Strong electrical odor. Strong oxidizer. Colorless. At 1 ppm, strong sulfur-like odor.	1.66	Max. naturally occurring level is 0.04 ppm. 0.05 ppm causes irritation of eyes and nose. 1 to 10 ppm causes headache, nausea; can cause coma. Symptoms similar to radiation damage.	0.08	0.04	— —	Near bottom.	Where ozone is used for disinfection.	Detectable odor at 0.015 ppm.

Table C-1 Hazardous Gases (Continued)

Gas	Chemical Formula	Common Properties	Specific Gravity or Vapor Density Air =1	Physiological Effect	Max Safe 60 Min. Exposure ppm	Max. Safe 8 Hour Exposure ppm	Explosive Range (% by vol. in air) Limits lower/upper	Likely Location of Highest Concentration	Most Common Sources	Simplest and Cheapest Safe Method of Testing
Sludge Gas	—***	Mostly a simple asphyxiant. May be practically odorless, tasteless.	Variable	Will not support life.	No data. Would vary widely with composition.		5.3 19.3	Near top of structure.	From digestion of sludge.	See components.
Sulfur Dioxide	SO ₂	Colorless, pungent odor. Suffocating, corrosive, poisonous, non-flammable.	2.26	Inflammation of the eyes. 400 to 500 ppm immediately fatal.	50 to 100	10	— —	At bottom, can combine with water to form sulfuric acid.	Industrial waste, combustion, common air pollutant.	Detectable taste and odor at low concentration.
Toluene	C ₆ H ₅ to C ₉ H ₂₀	Colorless, benzene-like odor.	3.14	At 200-500 ppm, headache, nausea, bad taste, lassitude.	200	100	1.27 7.0	At bottom.	Solvent.	Combustible gas indicator.
Turpentine	C ₁₀ H ₁₆	Colorless, Characteristic odor.	4.84	Eye irritation. Headache, dizziness, nausea, irritation of the kidneys.	—	100		At bottom.	Solvent, used in paint.	1. Detectable odor at low concentrations. 2. Combustible gas indicator.
Xylene	C ₈ H ₁₀	Colorless, flammable	3.66	Narcotic in high concentrations. less toxic than benzene.	—	100	1.1 7.0	At bottom.	Solvent	Combustible gas indicator.
<p>* Percentages shown represent volume of gas in air. ** For concentration over 0.3%. ***Mostly methane and carbon dioxide with small amounts of hydrogen, nitrogen, hydrogen sulfide, and oxygen; occasionally traces of carbon monoxide.</p>										

4230 Flow Meter

Appendix D Material Safety Data Sheets

D.1 Overview

This appendix provides Material Safety Data Sheets for the desiccant used by the 4230 Flow Meter.

Teledyne Isco cannot guarantee the accuracy of the data. Specific questions regarding the use and handling of the products should be directed to the manufacturer listed on the MSDS.

Material Safety Data Sheet

Indicating Silica Gel

Identity (Trade Name as Used on Label)

Manufacturer : MULTISORB TECHNOLOGIES, INC. (formerly Multiform Desiccants, Inc.)	MSDS Number* : M75
Address: 325 Harlem Road Buffalo, NY 14224	CAS Number* :
Phone Number (For Information): 716/824-8900	Date Prepared: July 6, 2000
Emergency Phone Number: 716/824-8900	Prepared By* : G.E. McKedy

Section 1 - Material Identification and Information

Components - Chemical Name & Common Names (Hazardous Components 1% or greater; Carcinogens 0.1% or greater)	%*	OSHA PEL	ACGIH TLV	OTHER LIMITS RECOMMENDED
Silica Gel SiO ₂	98.0	6mg/m ³ (total dust)	10mg/m ³ (total dust)	
Cobalt Chloride	>2.0	0.05mg/m ³ (TWA cobalt metal dust & fume)	.05mg/m ³ (Cobalt, TWA)	
Non-Hazardous Ingredients				
TOTAL	100			

Section 2 - Physical/Chemical Characteristics

Boiling Point	N/A	Specific Gravity (H ₂ O = 1)	2.1
Vapor Pressure (mm Hg and Temperature)	N/A	Melting Point	N/A
Vapor Density (Air =1)	N/A	Evaporation Rate (_____ =1)	N/A
Solubility in Water	Insoluble, but will adsorb moisture.	Water Reactive	Not reactive, but will adsorb moisture.
Appearance and Odor	Purple crystals, no odor.		

Section 3 - Fire and Explosion Hazard Data

Flash Point and Methods Used	N/A	Auto-Ignition Temperature	N/A	Flammability Limits in Air % by Volume	N/A	LEL	UEL
Extinguisher Media	Dry chemical, carbon dioxide and foam can be used.						
Special Fire Fighting Procedures	Water will generate heat due to the silica gel which will adsorb water and liberate heat.						
Unusual Fire and Explosion Hazards	When exposed to water, the silica gel can get hot enough to reach the boiling point of water. Flooding with water will reduce the temperature to safe limits.						

Section 4 - Reactivity Hazard Data

STABILITY <input type="checkbox"/> Stable <input type="checkbox"/> Unstable	Conditions To Avoid	Moisture and high humidity environments.
Incompatibility (Materials to Avoid)	Water.	
Hazardous Decomposition Products	Carbon dioxide, carbon monoxide, water	
HAZARDOUS POLYMERIZATION <input type="checkbox"/> May Occur	Conditions To Avoid	None.

*Optional

Indicating Silica Gel

Section 5 - Health Hazard Data

PRIMARY ROUTES OF ENTRY	<input type="checkbox"/> Inhalation <input type="checkbox"/> Ingestion <input type="checkbox"/> Skin Absorption <input type="checkbox"/> Not Hazardous	CARCINOGEN LISTED IN	<input type="checkbox"/> NTP <input type="checkbox"/> OSHA <input type="checkbox"/> IARC Monograph <input type="checkbox"/> Not Listed
HEALTH HAZARDS	Acute May cause eye, skin and mucous membrane irritation. Chronic Prolonged inhalation may cause lung damage.		
Signs and Symptoms of Exposure	Drying and irritation.		
Medical Conditions Generally Aggravated by Exposure	Asthma.		
EMERGENCY FIRST AID PROCEDURES - Seek medical assistance for further treatment, observation and support if necessary.			
Eye Contact	Flush with water for at least 15 minutes.		
Skin Contact	Wash affected area with soap and water.		
Inhalation	Remove affected person to fresh air.		
Ingestion	Drink at least 2 glasses of water.		

Section 6 - Control and Protective Measures

Respiratory Protection (Specify Type)	Use NIOSH approved dust mask or respirator.		
Protective Gloves	Light cotton gloves.	Eye Protection	Safety glasses.
VENTILATION TO BE USED	<input type="checkbox"/> Local Exhaust	<input type="checkbox"/> Mechanical (General)	<input type="checkbox"/> Special
	<input type="checkbox"/> Other (Specify)		
Other Protective Clothing and Equipment	None.		
Hygienic Work Practices	Avoid raising dust. Avoid contact with skin, eyes and clothing.		

Section 7 - Precautions for Safe Handling and Use/Leak Procedures

Steps to be Taken if Material Is Spilled Or Released	Sweep or vacuum up and place the spilled material in a waste disposal container. Avoid raising dust.
Waste Disposal Methods	Dispose in an approved landfill according to federal, state and local regulations.
Precautions to be Taken In Handling and Storage	Cover promptly to avoid blowing dust. Wash after handling.
Other Precautions and/or Special Hazards	Keep in sealed containers away from moisture. The silica gel will readily adsorb moisture.

*Optional

Indicating Silica Gel



MATERIAL SAFETY DATA SHEET

Effective Date March 8, 2005
MSDS Number M163

Section 1 – Product and Company Information

Product Name: Silica gel, indicating, yellow

Product Use: Desiccant, absorbent

Grades: Silica gel, indicating

Synonyms: Amorphous silica gel, SiO₂, silicon dioxide (amorphous)

Company; Multisorb Technologies, Inc.

Street Address: 325 Harlem Road

City, State, Zip, Country: Buffalo, NY 14224-1893 USA

Telephone Number: (716) 824 8900 [USA] Monday - Friday (8:00 - 5:00 EDT)

Fax Number: (716) 824 4091 [USA]

Website / E-Mail : multisorb.com

Section 2 – Composition / Information on Ingredients

Component Name	CAS Number	% by Weight
Synthetic amorphous silica gel (SiO ₂)	112926-00-8	100
Phenolphthalein	77-09-08	100 ppm

While this material is not classified, this MSDS contains valuable information critical to the safe handling and proper use of this product. This MSDS should be retained and available for employees and other users of this product.

Section 3 – Hazard Identification

Emergency Overview: A yellow bead or granular material that poses little or no immediate hazard. This material is not combustible.

Potential Health Effects:

Eyes: Dust and or product may cause eye discomfort and irritation seen as tearing and reddening.

Skin: The product dust may cause drying of the skin. Silica gel may get hot enough to burn skin when it adsorbs moisture rapidly. Use an excess of water to cool the silica gel.

Ingestion: Material is not toxic and will pass through the body normally.

Inhalation: Slight irritation is possible but none is expected.

Medical Effects Generally Aggravated by Exposure: Respiratory ailments.

Chronic Effects/Carcinogenicity: May cause eye, skin and mucous membrane irritation and drying.

Section 4 – First Aid Measures

- Eyes:** Rinse the eyes well with water while lifting the eye lids. If irritation persists, consult a physician.
- Skin:** Wash affected area with soap and water.
- Ingestion:** Ingestion is unlikely, this material will pass through the body normally.
- Inhalation:** Remove the affected person to fresh air and get medical attention if necessary.
- Notes to Physician:** Not applicable

Section 5 – Fire Fighting Measures

- Flammable Properties:** Not flammable
- Flash Point:** Not applicable **Method:** Not applicable
- Flammable Limits:** Not flammable
- Lower Flammability Limit:** Not applicable
- Upper Flammability Limit:** Not applicable
- Autoignition Temperature:** Not applicable
- Hazardous Combustion Products:** Not applicable
- Extinguishing Media:** Use extinguishing media that is appropriate for the surrounding fire. Silica gel is not combustible.
- Fire Fighting Instructions:** Not combustible
- Unusual Fire and Explosion Hazards:** None

Section 6 – Accidental Release Measures

- Spill:** Sweep or vacuum up and place the spilled material in a waste disposal container. Avoid raising dust. Wash with soap and water after handling.

Section 7 – Handling and Storage

- Handling:** Avoid raising dust and minimize the contact between worker and the material. Practice good hygienic work practices.
- Storage:** Store in a cool, dry location. Keep in sealed containers away from moisture. The silica gel will readily adsorb moisture.

Section 8 – Exposure Controls/Personal Protection

- Engineering Controls:** Use exhaust ventilation to keep the airborne concentrations below the exposure limits.
- Respiratory Protection:** Use NIOSH approved respirator when the air quality levels exceed the TLV's.
- Skin Protection:** Light gloves will protect against abrasion and drying of the skin.
- Eye Protection:** Safety glasses.

Component Name	Exposure Limits		
	OSHA PEL	ACGIH TLV	Other Recommended Limits
Silica gel	TWA 20 mppcf (80 mg / m ³ % SiO ₂)	TWA 10 mg / m ³	NIOSH REL TWA 6 mg / m ³ IDLH 3000 mg / m ³
Phenolphthalein	Not Applicable	Not Applicable	Not Applicable

Section 9 – Physical and Chemical Properties

- | | | | |
|------------------------|--------------------------|--------------------------|--------------------|
| Appearance: | Yellow beads or granules | Vapor Density: | Not applicable |
| Odor: | None | Boiling Point: | 4046° F (2230° C) |
| Physical State: | Solid bead | Melting Point: | 3110° F (1710° C) |
| PH: | Not applicable | Solubility: | Insoluble in water |
| Vapor Pressure: | Not applicable | Specific Gravity: | 2.1 |

Section 10 – Stability and Reactivity

- Stability:** Stable
- Conditions to avoid:** Moisture and high humidity environments.
- Incompatibility:** Water, fluorine, oxygen difluoride, chlorine trifluoride
- Hazardous Decomposition Products:** None
- Hazardous Polymerization:** Will not occur

Section 11 – Toxicological Information

This product and its components are not listed on the NTP or OSHA Carcinogen lists.

Animal Toxicology Tests for DOT Hazard classification
(Tests Conducted on finely ground silica gel)
1 - hour LC₅₀ (rat) > 2 mg / l
48 - hour oral LD₅₀ (rat) est. > 31,600 mg / kg
48 - hour dermal LD₅₀ (rabbit) est. > 2,000 mg / kg
Considered an ocular irritant

Human Toxicology Silica gel is a synthetic amorphous silica not to be confused with crystalline silica. Epidemiological studies indicate low potential for adverse health effects. In the activated form, silica gel acts as a desiccant and can cause a drying irritation of the mucous membranes and skin in cases of severe exposure. Multisorb Technologies Inc. knows of no medical conditions that are abnormally aggravated by exposure to silica gel. The primary route of entry is inhalation of dust.

Section 12 – Ecological Information

Not known to have any adverse effect on the aquatic environment. Silica gel is insoluble and non-toxic.

Section 13 – Disposal Information

Disposal Information If this product as supplied becomes a waste, it does not meet the criteria of a hazardous waste as defined under the Resource Conservation and Recovery Act (RCRA) 40 CFR 261. Materials of a hazardous nature that contact the product during normal use may be retained on the product. The user of the product must identify the hazards associated with the retained material in order to assess the waste disposal options. Dispose according to federal, state and local regulations.

Section 14 – Transportation Information

U.S. Department of Transportation Shipping Name: Not classified as a hazardous material. Not regulated.

Section 15 – Regulatory Information (Not meant to be all inclusive - selected regulations represented)

TSCA Listed: Yes

DSL/NDSL (Canadian) Listed: Yes

OSHA: TWA 20 mppcf (80 mg / m³ % SiO₂) for Silica gel

NIOSH: REL TWA 6 mg / m³ IDLH 3,000 mg / m³ for silica gel
Animal tests conducted in 1976 - 1978. 18 month exposure at 15 mg / m³ showed silica deposition in respiratory macrophages and lymph nodes, minimum lung impairment, no silicosis.

ACGIH: TLV - 10 mg / m³ for Silica gel

DOT: Not classified as a hazardous material.

HMIS – Hazardous Materials Identification System

HMIS Rating	
Health	0
Flammability	0
Reactivity	0

0 - minimal hazard, 1 - slight hazard, 2 - moderate hazard, 3 - serious hazard, 4 - severe hazard

This MSDS was prepared by: George E. Mckedy
Senior Applications Development Specialist
Multisorb Technologies, Inc.

This data and recommendations presented in this data sheet concerning the use of our product and the materials contained therein are believed to be correct but does not purport to be all inclusive and shall be used only as a guide. However, the customer should determine the suitability of such materials for his purpose before adopting them on a commercial scale. Since the use of our products is beyond our control, no guarantee, expressed or implied, is made and no responsibility assumed for the use of this material or the results to be obtained therefrom. Information on this form is furnished for the purpose of compliance with Government Health and Safety Regulations and shall not be used for any other purposes. Moreover, the recommendations contained in this data sheet are not to be construed as a license to operate under, or a recommendation to infringe, any existing patents, nor should they be confused with state, municipal or insurance requirements, or with national safety codes.

4230 Flow Meter

Index

Numerics

4 to 20 mA Output Interface, 4-5
4-20 mA Output, 2-17, 2-37, 4-5

A

Accessories List, A-8
Alarm Box, 4-9
Analog Output, 2-17, 2-37, 4-5
 External, 4-5
 Internal, 4-6

B

Battery Life Expectancy, 1-10
Bubble Line, 3-10
 Extensions, 3-15
 Flume Fittings, 3-15
 High-Velocity Flow Streams, 3-14
 Open Channel Installation, 3-16
 Stilling Wells, 3-15
Bubble Rate, 3-5
Bubbler System Operation, 5-11
Bubbler Tube Retainer Assembly, 3-18

C

CMOS Circuitry, 5-15
Compatible Equipment, 1-1
Current Draw, 1-11

D

Desiccant Canister, 3-1
Desiccant Cartridge, 3-1
 Venting, 3-1
Display Functions, 2-1

F

FLASH Update, 5-17
Flow Conversion
 Data Points, 2-35
 Equation, 2-33
 Flow Metering Inserts, 2-36
 Flume, 2-32
 Manning, 2-33
 Weir, 2-31
Flow Metering Inserts, 3-16
Flowlink Software, 4-2, 4-9

H

Hysteresis, 2-15

I

Installation
 Bubble Line, 3-12
 Flow Meter, 3-9
 Safety Considerations, 3-9

K

Keypad Functions, 2-2

M

Maintenance
 Bubble Line, 5-4
 Case, 5-1
 CPU, 5-14
 Desiccators, 5-2
 Fuses, 5-9
 Getting Help, 5-14
 Printer
 Ink Ribbon, 5-7
 Paper Roll, 5-5
 Servicing CMOS Circuitry, 5-15
 System Reset, 5-10
 Troubleshooting Steps, 5-14
Material Safety Data Sheets, D-1
Maximum Head, 2-37
Modem, 4-1
Mounting
 Parameter Probes, 4-26
Mounting Rings
 Universal Mounting Ring, 4-27
MSDS, D-1

O

Operating Principles, 1-2
 Bubbler System, 1-3, 5-11
 Drift Compensation, 1-3
 Pressure Transducer, 1-3
Optional Equipment
 4200T Modem, 4-1
 Dissolved Oxygen Probe, 4-19
 External Analog Output Interface, 4-5
 Flowlink Software, 4-9
 High-Low Alarm Relay Box, 4-9
 Internal Analog Output Board, 4-6
 Mechanical Totalizer, 4-31

- pH Probe, 4-12
- Rain Gauge, 4-8
- Temperature Probe, 4-12
- YSI 600 Sonde, 4-28
- Optional Outputs
 - Analog, 2-17, 2-37, 4-5
 - Serial, 2-19, 4-4

P

- Parameter Sensing, 4-11
- Power Consumption, 1-9, 1-10
 - Bubble Rate, 3-6
- Power Loss, 3-2
- Power Sources, 3-2
 - AC Power Supplies, 3-4
 - Battery-Backed Power Pack, 3-4
 - High Capacity Power Pack, 3-4
 - External 12 V Battery, 3-5
 - Lead-Acid Battery, 3-4
 - Nickel-Cadmium Battery, 3-3
 - Sampler, 3-3
- Program Steps - Description, 2-5
- Programming, 2-3
- Programming Steps
 - Step 1 - Operating Mode, 2-12
 - Step 2 - Flow Conversion, 2-31
 - Step 3 - Parameter to Adjust, 2-38
 - Step 4 - Reset Totalizer, 2-45
 - Step 5 - Sampler Pacing, 2-45
 - Step 6 - Sampler Enable, 2-47
 - Step 7 - Alarm Dialout, 2-51
 - Step 8 - Printer, 2-53
 - Step 9 - Reports/History, 2-55
- Programming Worksheets, B-1
- Purge Interval, 2-13

R

- Rain Gauge, 4-8
- Replacement Parts, A-1
- Reports, 2-23

S

- Safety, C-1
 - Hazardous Gases, C-6
 - Lethal Atmospheres in Sewers, C-4
 - Precautions, C-1
- Sampler Connection, 3-18
- Scissors Ring, 4-27
- Serial Output, 2-19, 4-4
 - ASCII Codes, 2-20
- Software
 - Flowlink, 4-2, 4-9
 - System Reset, 5-10
 - Updating, 5-17
- Specifications, 1-4
- Spring Rings, 4-26
- Super Bubble, 3-8

T

- Technical Specifications, 1-4
- Tipping Bucket Rain Gauge, 4-8
- Troubleshooting Steps, 5-14

Y

- YSI 600 Sonde, 4-28
 - Calibration, 2-41

产品中有毒有害物质或元素的名称及含量

Name and amount of Hazardous Substances or Elements in the product

部件名称 Component Name	有毒有害物质或元素 Hazardous Substances or Elements					
	铅 (Pb)	汞 (Hg)	镉 (Cd)	六价铬 (Cr(VI))	多溴联苯 (PBB)	多溴二联苯 (PBDE)
线路板 Circuit Boards	X	O	O	O	O	O
显示 Display	X	O	O	O	O	O
接线 Wiring	O	O	O	O	X	O
小键盘 Keypad	O	O	O	O	X	O
直流电机 DC Motor	X	O	O	O	X	O
接头 Connectors	O	O	X	O	O	O

产品中有毒有害物质或元素的名称及含量：Name and amount of Hazardous Substances or Elements in the product

O: 表示该有毒有害物质在该部件所有均质材料中的含量均在ST/ 标准规定的限量要求以下。

O: Represent the concentration of the hazardous substance in this component's any homogeneous pieces is lower than the ST/ standard limitation.

X: 表示该有毒有害物质至少在该部件的某一均质材料中的含量超出ST/ 标准规定的限量要求。

(企业可在此处，根据实际情况对上表中打“X”的技术原因进行进一步说明。)

X: Represent the concentration of the hazardous substance in this component's at least one homogeneous piece is higher than the ST/ standard limitation.

(Manufacturer may give technical reasons to the “X”marks)

环保使用期由经验确定。

The Environmentally Friendly Use Period (EFUP) was determined through experience.

生产日期被编码在系列号码中。前三位数字为生产年(207 代表 2007 年)。随后的一个字母代表月份：

A 为一月，B 为二月，等等。

The date of Manufacture is in code within the serial number. The first three numbers are the year of manufacture (207 is year 2007) followed by a letter for the month. "A" is January, "B" is February and so on.

DECLARATION OF CONFORMITY

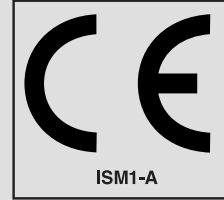

Application of Council Directive: 89/336/EEC – The EMC Directive
73/23/EEC – The Low Voltage Directive
Manufacturer's Name: Teledyne Isco, Inc.
Manufacturer's Address: 4700 Superior, Lincoln, Nebraska 68504 USA
Mailing Address: P.O. Box 82531, Lincoln, NE 68501
Equipment Type/Environment: Laboratory Equipment for Light Industrial/Commercial Environments
Trade Name/Model No: Model 4230 Bubbler Flow Meter
Year of Issue: 2000

Standards to which Conformity is Declared: EN 50082-1 Generic Immunity for Commercial, Light Industrial Environment
EN 61010-1 Safety Requirements for Electrical Equipment for Measurement, Control, and Laboratory Use

Standard	Description	Severity Applied	Performance Criteria
IEC 801.2	Electrostatic Discharge	Level 2 - 4kV contact discharge Level 3 - 8kV air discharge	B B
IEC 801.3	Radiated RF Immunity	27 MHz to 500MHz *Level 2 - 3 V/m	A
IEC 801.4	Electrical Fast Transient	Level 2 - 1kV on ac lines	B
CISPR11/ EN 55011	RF Emissions	Group 1, Class A Industrial, Scientific, and Medical Equipment	

*Instrument is susceptible to 3V/m between 105 mHz and 500 mHz.

We, the undersigned, hereby declare that the design of the equipment specified above conforms to the above Directive(s) and Standards as of January 1, 1997

William Foster
USA Representative



William Foster
Director of Engineering
Teledyne Isco, Inc.
4700 Superior Street
Lincoln, Nebraska 68504
Phone: (402) 464-0231
Fax: (402) 464-4543

60-3232-023
Rev. B

DECLARATION OF CONFORMITY

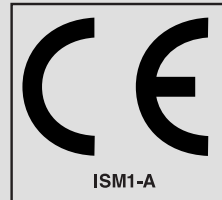

Application of Council Directive: 89/336/EEC – The EMC Directive
73/23/EEC – The Low Voltage Directive

Manufacturer's Name: Teledyne Isco, Inc.
Manufacturer's Address: 4700 Superior, Lincoln, Nebraska 68504 USA
Mailing Address: P.O. Box 82531, Lincoln, NE 68501

Equipment Type/Environment: Laboratory Equipment for Light Industrial/Commercial Environments
Trade Name/Model No: 4200T Modem
Year of Issue: 2001

Standards to which Conformity is Declared: EN 55024-1998 EMC Requirements for Information Technology Equipment
EN 60950 Safety Requirements for Information Technology Equipment
FCC Part 68

Standard	Description	Severity Applied	Performance Criteria
EN61000-4-2	Electrostatic Discharge	Level 2 - 4kV contact discharge Level 3 - 8kV air discharge	B B
EN61000-4-3	Radiated RF Immunity	80 MHz to 1000MHz 80% AM at 1kHz Level 1 – 10V/m	A
EN61000-4-4	Electrical Fast Transient	Level 2 - 2kV on ac lines	B
EN61000-4-5	Surge on AC Lines	2kV common mode, 1kV differential mode	B
EN61000-4-6	Conducted RF on AC lines	150 kHz to 80 MHz, 3V rms, 80% modulated	B
EN61000-4-11	Voltage Dips/Short Interruptions	0.5 cycle, each polarity/100%	B
EN 55022	RF Emissions	Group 1, Class A, Information Technology Equipment	
EN61000-3-2, 3-3	Harmonic, Flicker		

We, the undersigned, hereby declare that the design of the equipment specified above conforms to the above Directive(s) and Standards as of July 5, 2001.

William Foster
USA Representative



William Foster
Director of Engineering
Teledyne Isco, Inc.
4700 Superior Street
Lincoln, Nebraska 68504

Phone: (402) 464-0231
Fax: (402) 464-4543

60-3212-049
Rev. A

Teledyne Isco One Year Limited Factory Service Warranty *

Teledyne Isco warrants covered products against failure due to faulty parts or workmanship for a period of one year (365 days) from their shipping date, or from the date of installation by an authorized Teledyne Isco Service Engineer, as may be appropriate.

During the warranty period, repairs, replacements, and labor shall be provided at no charge. Teledyne Isco's liability is strictly limited to repair and/or replacement, at Teledyne Isco's sole discretion.

Failure of expendable items (e.g., charts, ribbon, tubing, lamps, glassware, seals, filters, fittings, and wetted parts of valves), or from normal wear, accident, misuse, corrosion, or lack of proper maintenance, is not covered. Teledyne Isco assumes no liability for any consequential damages.

This warranty does not cover loss, damage, or defects resulting from transportation between the customer's facility and the repair facility.

Teledyne Isco specifically disclaims any warranty of merchantability or fitness for a particular purpose.

This warranty applies only to products sold under the Teledyne Isco trademark and is made in lieu of any other warranty, written or expressed.

No items may be returned for warranty service without a return authorization number issued from Teledyne Isco.

The warrantor is Teledyne Isco, Inc.
4700 Superior, Lincoln, NE 68504, U.S.A.

*** This warranty applies to the USA and countries where Teledyne Isco Inc. does not have an authorized dealer. Customers in countries outside the USA, where Teledyne Isco has an authorized dealer, should contact their Teledyne Isco dealer for warranty service.**

In the event of instrument problems, always contact the Teledyne Isco Service Department, as problems can often be diagnosed and corrected without requiring an on-site visit. In the U.S.A., contact Teledyne Isco Service at the numbers listed below. International customers should contact their local Teledyne Isco agent or Teledyne Isco International Customer Service.

Return Authorization

A return authorization number must be issued prior to shipping. Following authorization, Teledyne Isco will pay for surface transportation (excluding packing/crating) both ways for 30 days from the beginning of the warranty period. After 30 days, expense for warranty shipments will be the responsibility of the customer.

Shipping Address: Teledyne Isco, Inc. - Attention Repair Service
4700 Superior Street
Lincoln NE 68504 USA

Mailing address: Teledyne Isco, Inc.
PO Box 82531
Lincoln NE 68501 USA

Phone: Repair service: (800)775-2965 (lab instruments)
(800)228-4373 (samplers & flow meters)
Sales & General Information (800)228-4373 (USA & Canada)

Fax: (402) 465-3001

Email: iscoservice@teledyne.com **Web site:** www.isco.com



