

710 Ultrasonic Module

Installation and Operation Guide



Part #60-9003-062
Copyright © 1995, 2003. All rights reserved, Isco, Inc.
Revision D, December 2003

Isco, Inc.

Foreword

This instruction manual is designed to help you gain a thorough understanding of the operation of the equipment. Isco recommends that you read this manual completely before placing the equipment in service.

Although Isco designs reliability into all equipment, there is always the possibility of a malfunction. This manual may help in diagnosing and repairing the malfunction.

If the problem persists, call or email the Isco Customer Service Department for assistance. Contact information is provided below. Simple difficulties can often be diagnosed over the phone. If it is necessary to return the equipment to the factory for service, please follow the shipping instructions provided by the Customer Service Department, including the use of the **Return Authorization Number** specified. **Be sure to include a note describing the malfunction.** This will aid in the prompt repair and return of the equipment.

Isco welcomes suggestions that would improve the information presented in this manual or enhance the operation of the equipment itself.

Isco is continually improving its products and reserves the right to change product specifications, replacement parts, schematics, and instructions without notice.

Contact Information

Phone:	(800) 228-4373	(USA, Canada, Mexico)
	(402) 464-0231	(Outside North America)
Repair Service:	(800) 775-2965	(Analytical and Process Monitoring Instruments)
	(800) 228-4373	(Samplers and Flow Meters)
Fax:	(402) 465-3022	
Email address:	info@isco.com	
Website:	www.isco.com	
Return equipment to:	4700 Superior Street, Lincoln, NE 68504-1398	
Other correspondence:	P.O. Box 82531, Lincoln, NE 68501-2531	

General Warnings

This product is often installed in confined spaces. Some examples of confined spaces are manholes, pipelines, digesters, and storage tanks. These spaces may become hazardous environments that can prove fatal for those unprepared. These spaces are governed by OSHA 1910.146 and require a permit before entering.

Hazard Severity Levels

This manual applies *Hazard Severity Levels* to the safety alerts. These three levels are described in the sample alerts below.

 **CAUTION**

Cautions identify a potential hazard, which if not avoided, may result in minor or moderate injury. This category can also warn you of unsafe practices, or conditions that may cause property damage.

 **WARNING**













Warnings identify a potentially hazardous condition, which if not avoided, could result in death or serious injury.

 **DANGER**

DANGER – limited to the most extreme situations to identify an imminent hazard, which if not avoided, will result in death or serious injury.

Hazard Symbols

The equipment and this manual use symbols used to warn of hazards. The symbols are explained below.

Hazard Symbols	
Warnings and Cautions	
	The exclamation point within the triangle is a warning sign alerting you of important instructions in the instrument's technical reference manual.
	The lightning flash and arrowhead within the triangle is a warning sign alerting you of "dangerous voltage" inside the product.
 	Pinch point. These symbols warn you that your fingers or hands will be seriously injured if you place them between the moving parts of the mechanism near these symbols.
Symboles de sécurité	
	Ce symbole signale l'existence d'instructions importantes relatives au produit dans ce manuel.
	Ce symbole signale la présence d'un danger d'électocution.
 	Risque de pincement. Ces symboles vous avertit que les mains ou les doigts seront blessés sérieusement si vous les mettez entre les éléments en mouvement du mécanisme près de ces symboles
Warnungen und Vorsichtshinweise	
	Das Ausrufezeichen in Dreieck ist ein Warnzeichen, das Sie darauf aufmerksam macht, daß wichtige Anleitungen zu diesem Handbuch gehören.
	Der gepfeilte Blitz im Dreieck ist ein Warnzeichen, das Sie vor "gefährlichen Spannungen" im Inneren des Produkts warnt.
 	Vorsicht Quetschgefahr! Dieses Symbol warnt vor einer unmittelbar drohenden Verletzungsgefahr für Finger und Hände, wenn diese zwischen die beweglichen Teile des gekennzeichneten Gerätes geraten.

710 Ultrasonic Module

Table of Contents

Section 1 Installation and Programming

1.1 Introduction	1-1
1.1.1 Installing the Module	1-1
1.1.2 Installation Checklist	1-2
1.2 Programming Notes	1-2
1.2.1 Programmed Enable	1-3
1.3 Mounting the Ultrasonic Level Sensor	1-7
1.3.1 User-Determined Mounting Location	1-8
1.3.2 Dead Band	1-8
1.3.3 Accidental Submersion	1-10
1.4 Mounting the Sensor	1-10
1.4.1 Use a Level	1-10
1.4.2 Remove the Protector Cap	1-10
1.5 Maintenance	1-13
1.6 How to Get Help	1-13
1.7 Flash Memory and Software Upgrades	1-13

Section 2 The Ultrasonic Level Sensor

2.1 Description	2-1
2.2 Transducer Operation	2-1
2.2.1 Validity Tests	2-1
2.2.2 Ambient Air Temperature Factor	2-1
2.2.3 Return Echo Amplifier Compensation	2-1
2.3 Error Factors and Module Compensation	2-3
2.3.1 Velocity Errors	2-3
2.3.2 Echo Detect Errors	2-3
2.3.3 Beam Angle	2-3
2.3.4 Noise	2-3
2.3.5 Surface Objects	2-3
2.3.6 Temperature	2-4
2.3.7 Waves	2-4
2.3.8 Wavelength	2-4
2.3.9 Wind	2-4
2.3.10 Other Factors	2-4
2.4 Minimizing Level Measurement Errors	2-5
2.4.1 Temperature Differences	2-5
2.4.2 Avoid Wind	2-5
2.4.3 Excessive Distance	2-5
2.4.4 Calibration Temperature	2-6
2.4.5 Water Condensation	2-6
2.4.6 Foam, Oil, and Turbulence	2-6
2.4.7 Small Pipes and Channels	2-7
2.4.8 Alternative Flow Measurement Systems	2-8

Appendix A Accessories

Appendix B Technical Specifications

List of Figures

1-1	710 Module Installed on Sampler	1-2
1-2	6712 Programming: 710 Module Screens	1-4
1-3	6712 Programming: 710 Module Setup Screens	1-5
1-4	6712 Programming: 710 Quick View Screens	1-6
1-5	Ultrasonic Level Sensor Dead Band	1-8
1-6	Level Change, Temperature, and Calibration Factors	1-9
1-7	Mounting the Ultrasonic Level Sensor	1-11
1-8	Mounting the Ultrasonic Level Sensor (Continued)	1-12
2-1	Ultrasonic Level Sensor Operation	2-2
2-2	Foam and Oil on the Surface of the Flow Stream	2-6
2-3	Small Pipes and Narrow Channels	2-7

List of Tables

1-1	Flow Conversion Methods	1-7
B-1	Technical Specifications for the 710 Module	B-1

710 Ultrasonic Module

Section 1 Installation and Programming

1.1 Introduction

The 710 Ultrasonic Module is one of Isco's interchangeable modules for the Avalanche and 6700 Series Samplers. The module uses ultrasonic reflection to measure level. The ultrasonic level sensor is usually installed with some type of primary measuring device, such as a weir or flume. The module is dependable and easily installed. The ultrasonic sonic transducer is unaffected by corrosive chemicals.

You can install the module only on a 6712 or 6700 controller. The ultrasonic level sensor can be used in nearly any location with a known level-to-flow relationship where it can be suspended at least one foot above the highest anticipated level of the liquid.

 WARNING
--

The module has not been approved for use in hazardous locations as defined by the National Electrical Code. Installation of this module in a hazardous location may cause fire or explosion resulting in death, personal injury, or property damage. Before installing any device in a dangerous location, review safety precautions in your sampler manual. Check applicable guidelines, codes, and regulations of federal, state, city, and county agencies.

1.1.1 Installing the Module

To install the module:

1. Turn the sampler off.
2. Remove the connector cap in the module bay and move it aside.
3. Slide the module into the bay.
4. Push against the module to be sure the connector is fully seated.

To remove the module, turn the sampler off. Press the silver button and pull the module from the bay. Replace the connector cap in the module bay.



Figure 1-1 710 Module Installed on Sampler

1.1.2 Installation Checklist

1. Install the module and turn the sampler on.
2. Install the level sensor over the channel.
3. Connect the level sensor's cable to the module.
4. Program the sampler and calibrate the module's level reading.
5. Set up the sampler. See details in the sampler manual.
6. Run the program.

1.2 Programming Notes

You should install the module before turning the controller on. When the controller is turned on, it looks for a module. The controller will not recognize a newly installed module if it is not seen during this power-up routine. If you install a module while the controller is already on, turn the controller off and then on again to reconfigure the controller for use with the module.

When the controller is configured with the module, it adds the necessary screens for programming. The screens appear on the following pages in Figures 1-2, 1-3, and 1-4. These figures outline the steps for module programming and calibration. For 6712 programming and general programming information, see the sampler manual.

An asterisk (*) appears next to a reading if the module was unable to take a reading. If an asterisk appears, the reading displayed is the last available reading.

1.2.1 Programmed Enable

When a 710 Module is installed, additional sampler enable options are available. If programmed for LEVEL ONLY, the additional option is LEVEL. If programmed for FLOW METER, the additional options will be LEVEL and FLOW. For more information about programmed enables, see the sampler manual.

710 Ultrasonic Module
 Section 1 Installation and Programming

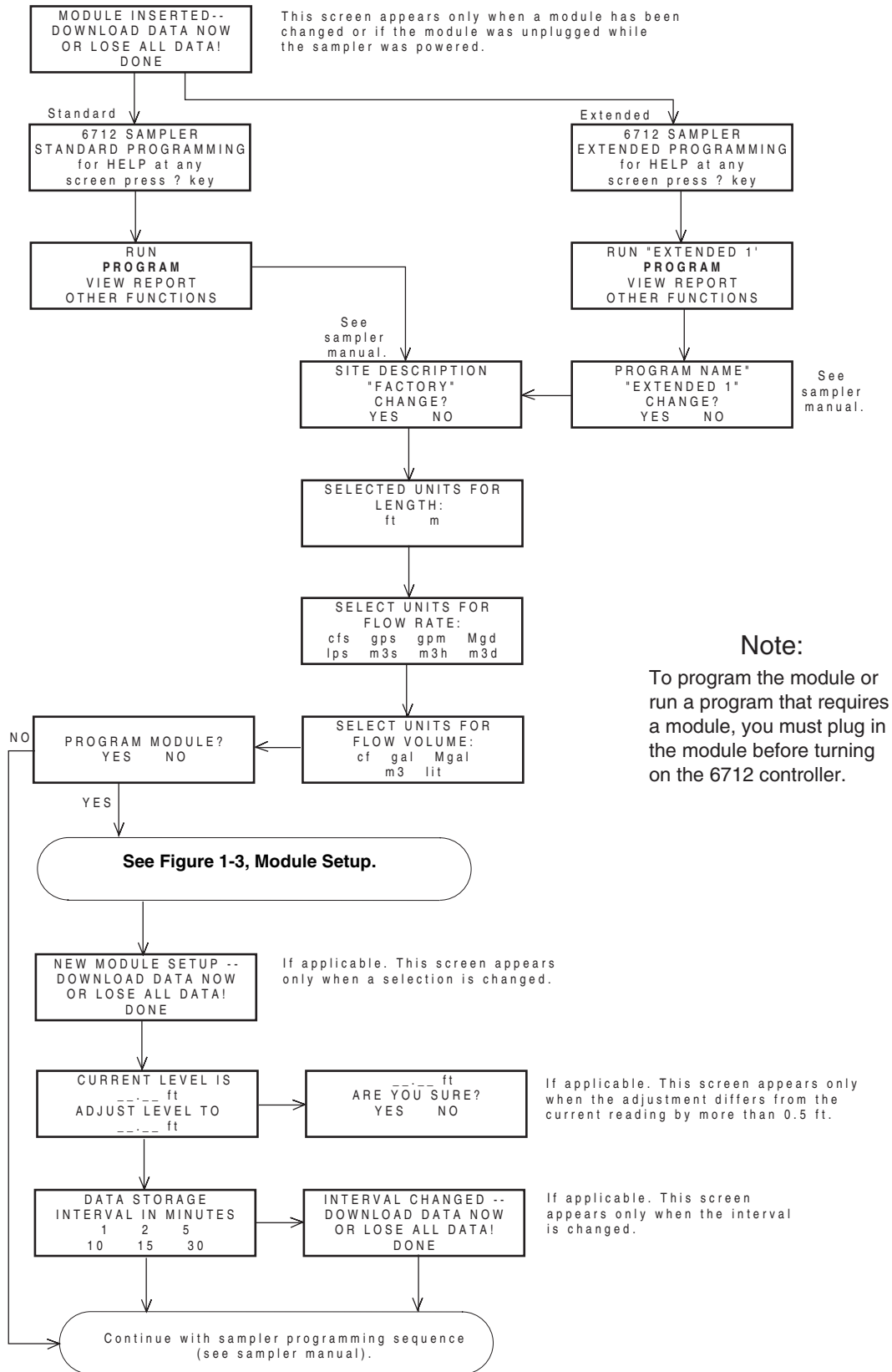

Figure 1-2 6712 Programming: 710 Module Screens

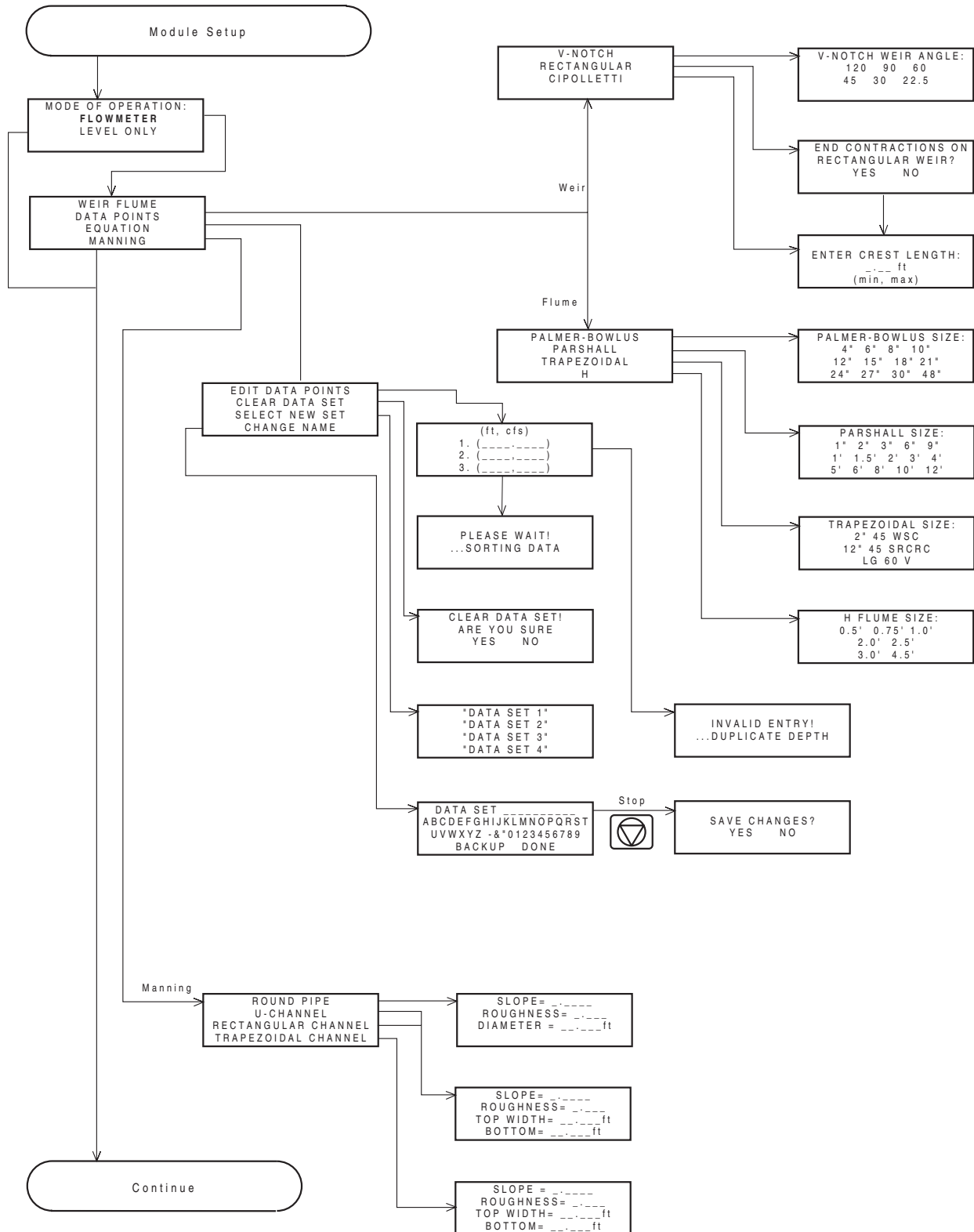

Figure 1-3 6712 Programming: 710 Module Setup Screens

710 Ultrasonic Module
 Section 1 Installation and Programming

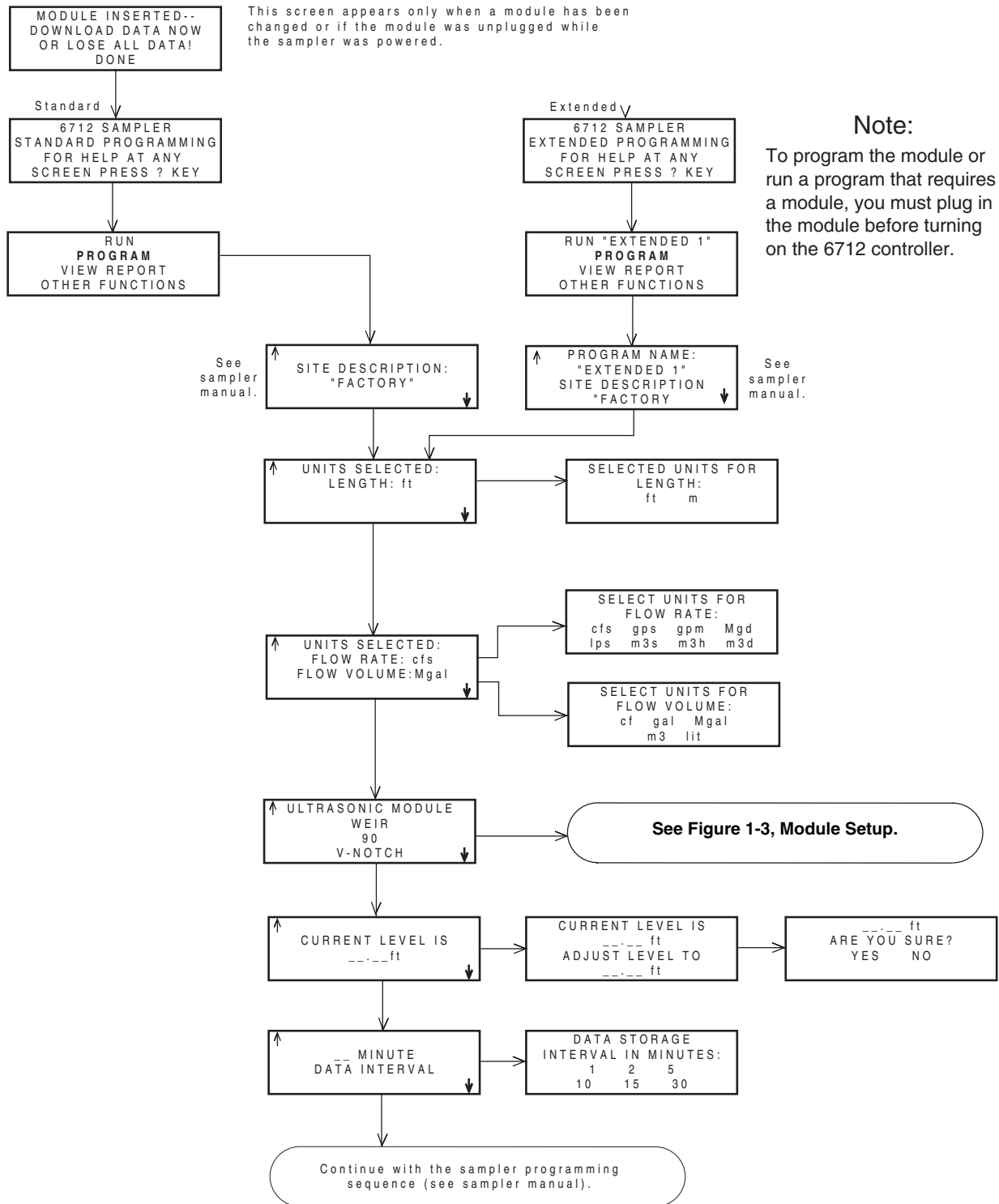

Figure 1-4 6712 Programming: 710 Quick View Screens

1.3 Mounting the Ultrasonic Level Sensor

The location of the ultrasonic level sensor depends on the method of level-to-flow rate conversion used. The ultrasonic level sensor is usually installed with some type of primary measuring device, such as a weir or flume. The location of the ultrasonic level sensor over the primary device depends on the type of primary device used. Most primary devices have a specific place for the head (level) measurement device. For example, the head measuring point of a weir is at least three times the expected maximum head upstream from the weir plate. For Parshall flumes, the measuring point is $\frac{1}{3}$ of the way into the converging section. For Palmer-Bowlus flumes, the measuring point is at least $\frac{1}{2}$ of the pipe diameter upstream from the entrance to the flume. For more details about the location of the head measuring point, refer to the *Isco Open Channel Flow Measurement Handbook*, or to information provided by the manufacturer of the primary device. A list of available level-to-flow conversions appears in the following table.

Table 1-1 Flow Conversion Methods

Conversion Type	Device, Formula, or Table	Size of Parameters
Weir	V- Notch Weir	22.5, 30, 45, 60, 90, 120 degrees.
	Rectangular Weir with End Contractions	Crest length.
	Rectangular Weir without End Contractions	Crest length.
	Cipoletti Weir	Crest length.
Flume	Palmer-Bowlus Flume	4, 6, 8, 10, 12, 15, 18, 21, 24, 27, 30, 48 inches.
	Parshall Flume	1, 2, 3, 6, 9 inches. 1, 1.5, 2, 3, 4, 5, 6, 8, 10, 12 feet.
	Trapezoidal Flume	Large 60-degree V. 2-inch, 45-degree WSC. 12-inch, 45-degree SRCRC.
	"H" Flume	0.5, 0.75, 1, 1.5, 2, 2.5, 3, 4.5 feet.
Equation	$Q = a \times H^{b+c} \times H^d$	Q = flow H = head a, b, c, & d = entered values
Data Points	User-developed tables for level-to-flow rate.	3 to 50 data points.
Manning Equation	Round Pipe	Slope, Roughness, Diameter.
	U-Channel Pipe	Slope, Roughness, width.
	Rectangular Pipe	Slope, Roughness, Width.
	Trapezoidal	Slope, Roughness, Bottom Width, Top Width.

1.3.1 User-Determined Mounting Location

If you intend to measure flow by some other means, such as a gravity flow equation (Manning) or by calibrating a section of the flow channel, you will have to determine the location for the ultrasonic level sensor. You should base this location on the hydraulic characteristics of the site and the method of level-to-flow rate conversion used.

1.3.2 Dead Band

Mount the ultrasonic level sensor as close to the maximum expected level as possible. This minimizes many of the undesirable characteristics of ultrasonic distance measurement. However, you *must* mount the ultrasonic level sensor at least one foot higher than the maximum expected level. This is a result of the one foot “dead band” directly below the level sensor where no measurements can be taken.

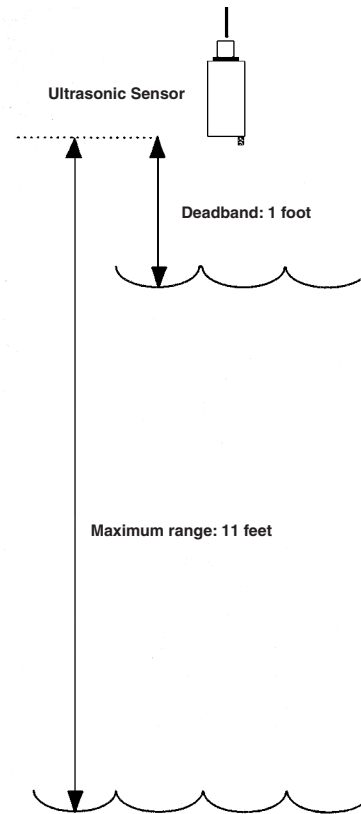
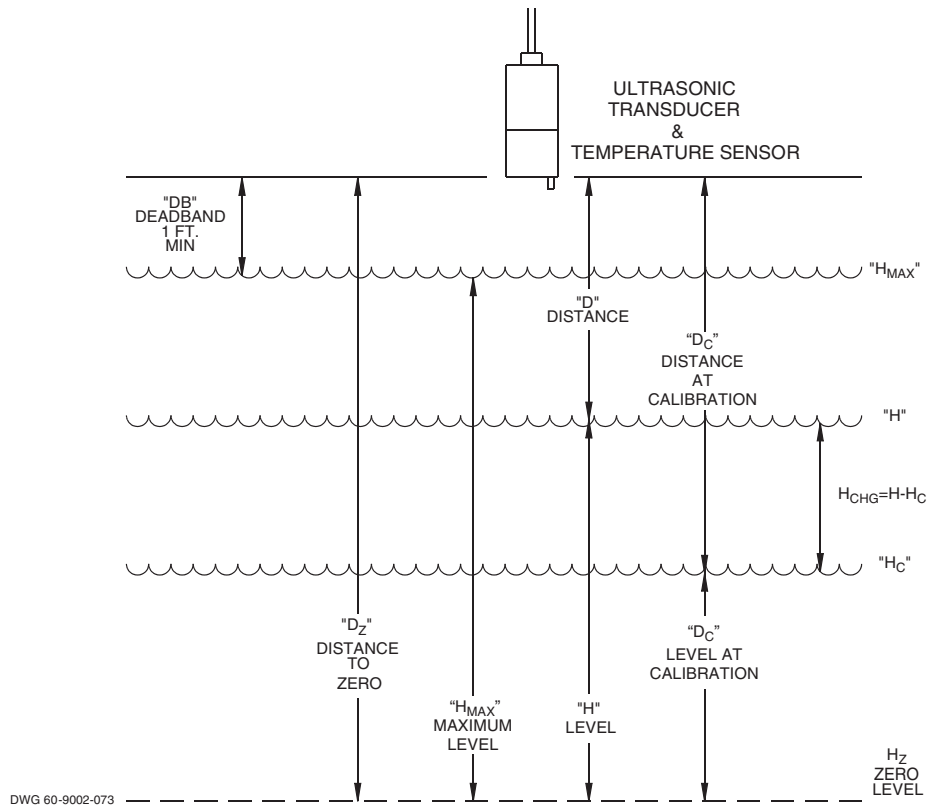

Figure 1-5 Ultrasonic Level Sensor Dead Band

Note

Do not mount the sensor over turbulent flow, such as round pipe openings in manholes where the flow may exceed one half of full-pipe. Turbulence occurs at the transition between each round pipe opening and the U-channel. Under these conditions, you *must* place the sensor over the least turbulent flow. This is usually the midpoint of the length of the U-channel.



DEAD BAND : The non-usable distance (1 foot) between the level sensor and the liquid surface. this requires that at maximum level the liquid surface be at least 1 foot from the level sensor.

DISTANCE "D" is the distance from the level sensor to the liquid surface. For the module, this distance can be from 1 to 11 feet.

"Dc" is the distance from the level sensor to the liquid surface at the time the level "H" was calibrated.

"Dz" is the distance from the level sensor to the zero level "Hz" of the primary device. Note that errors caused by the velocity of sound will be multiplied by the distance from the level sensor to the liquid surface "D." As the distance "D" increases, the possibility of error increases.

LEVEL : The depth of water above the primary device's zero level "Hz" point. May also be referred to as head. In this manual, "level" and "head" are interchangeable terms. The module calculates level using the following formula: $H = Dz - D$.

"Hc" is the level when the module was calibrated.

"H" is the level at the present time. "H" is shown above "Hc." However, if the level had dropped after calibration, "H" would be below "Hc."

LEVEL CHANGE "Hchg" : is the change in level over time. The maximum change in level that the module can detect is 10 feet. $Hchg = H - Hc$.

MAXIMUM HEAD "Hmax" : is the maximum level that the module can measure. This is dependent on the installation of the sensor (the distance from the sensor to the liquid) and the calibration of the module. For example, if the sensor is installed 5 feet from the liquid level and this level is entered as 10 feet, then the maximum head will be 14 feet.

TEMPERATURE : Since temperature significantly affects the velocity of sound, a temperature measurement is made by the module to provide compensation.

CALIBRATION TEMPERATURE "Tc" : is the temperature at the level sensor at the time the system is calibrated. (Not shown on the drawing.)

TEMPERATURE CHANGE "chg" : is the change in the temperature after the head was calibrated. $chg = T - Tc$. Note that the temperature is used to calculate the distance "D" to the liquid surface, and the head. Any error in the temperature "T" causes an error that is proportional to the distance "D."

Figure 1-6 Level Change, Temperature, and Calibration Factors

1.3.3 Accidental Submersion Since both ends of the ultrasonic level sensor are completely sealed, temporary submersion in the flow stream should not cause any harm. However, you should avoid prolonged submersion.

1.4 Mounting the Sensor There are many ways to suspend or mount the ultrasonic level sensor over the flow stream. Some are shown in Figures 1-7 and 1-8 in this manual. Mounting hardware is listed in Appendix A. Select the method that best suits your application.

In stable, indoor environments, you can simply suspend the ultrasonic level sensor from its cable. A Cable Straightener, which forces the ultrasonic level sensor to hang plumb, is available to help in this mounting method.

1.4.1 Use a Level When you mount the ultrasonic level sensor, place it over the center of the flow stream and use a circular bubble level to align it vertically. This is very important, since misalignment may result in erratic or erroneous level readings because of echo bouncing off the walls of the channel.

1.4.2 Remove the Protector Cap The ultrasonic level sensor is shipped with a protective cap covering the transducer. Remove the cap after the level sensor is installed, as it will prevent correct operation if left in place.

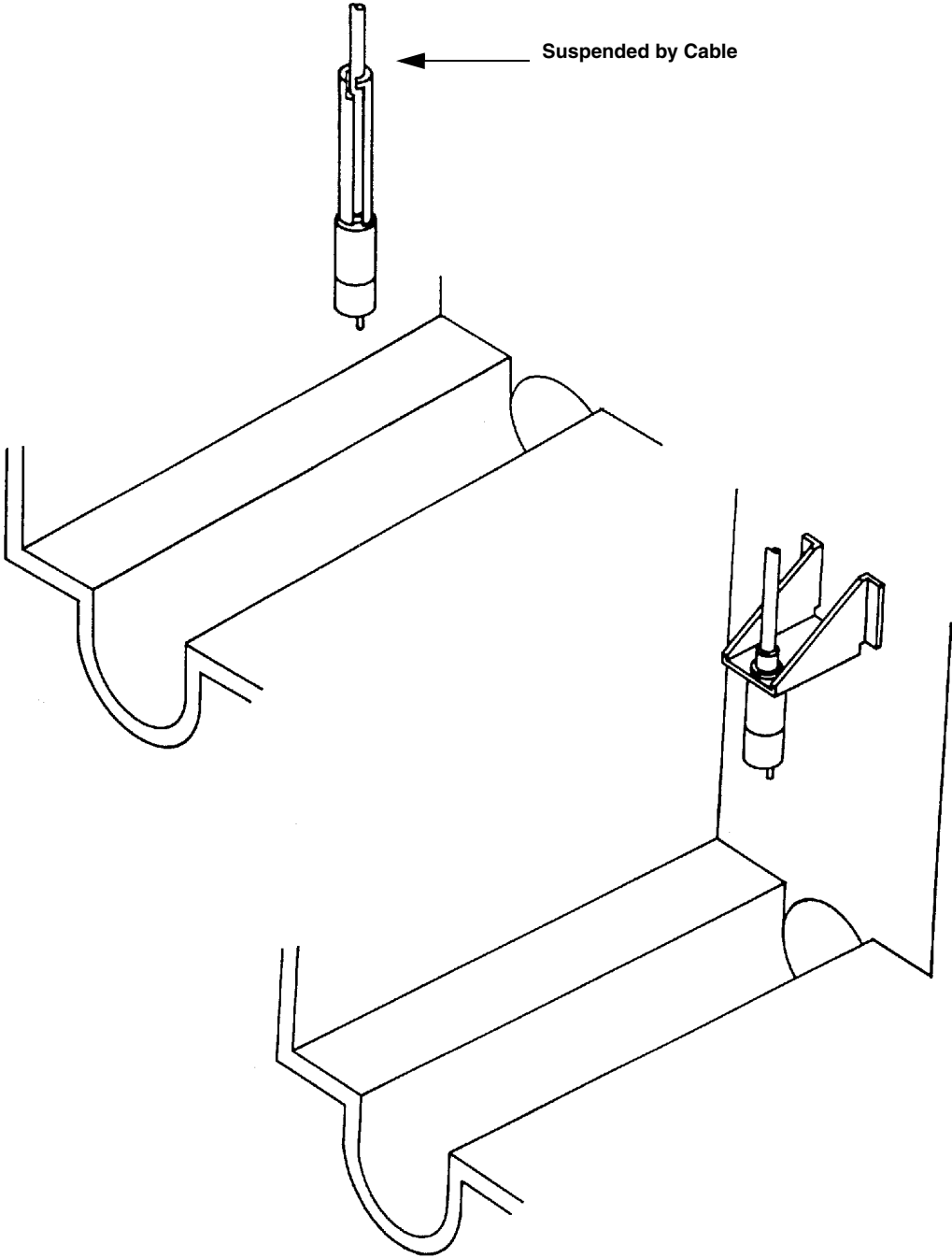

Figure 1-7 Mounting the Ultrasonic Level Sensor

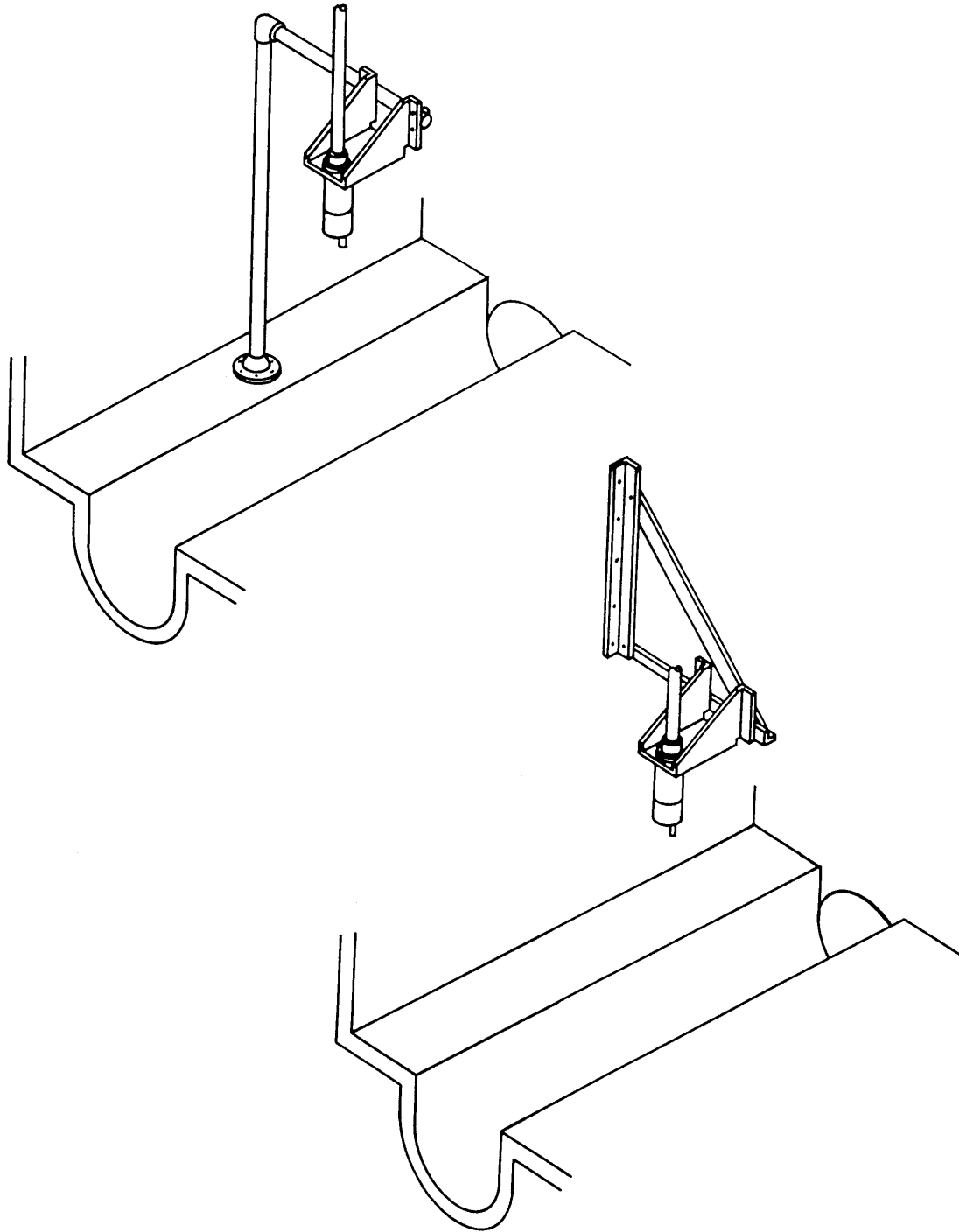

Figure 1-8 Mounting the Ultrasonic Level Sensor (Continued)

1.5 Maintenance

The ultrasonic level sensor requires little maintenance. It is encapsulated for protection from the environment. The level sensor's transducer surface is aluminum, coated with a Teflon[®] film. Do not scratch or score the surface; the transducer may be damaged.

If the transducer's surface becomes contaminated due to long term use or accidental submersion, operation of the unit may be impaired. If this happens, clean the case with a brush, but do not brush the transducer's surface or it may be damaged. Clean the surface of the transducer with gently flowing water.

Do not drop the assembly, nor attempt to take it apart. The ultrasonic level sensor contains no user-serviceable parts. Its case is completely sealed to protect the internal components. Repair of the unit must be done at the factory. If you think your module requires repair, contact Isco's Technical Service Department.

1.6 How to Get Help

If you need help or have repair questions, contact Isco's Technical Service Department.

Isco Technical Service Department
P.O. Box 82531
Lincoln, Nebraska, 68501 (USA)

Telephone: (402) 464-0231
Toll Free: (800) 228-4373 (Within USA, Canada, and Mexico)
FAX: (402) 464-3001

1.7 Flash Memory and Software Upgrades

The module has Flash memory to store its software. With Flash technology, you can upgrade your module's software without sending it back to the factory or replacing a chip. To update the module software, install the module in an Avalanche or 6712 Sampler. Then connect the sampler power source and turn the sampler on. Connect the sampler to a computer and follow the instructions received with your Flash Update program.

710 Ultrasonic Module

Section 2 The Ultrasonic Level Sensor

2.1 Description

The ultrasonic level sensor mounts directly over the flow stream. The module measures level by transmitting an ultrasonic pulse toward the liquid surface and then measuring the time it takes for the echo to return.

The ultrasonic level sensor consists of an enclosure with a single transducer acting both as a pulse transmitter and echo receiver. Since the speed of the pulse through the air varies with temperature, compensation is built in. A sensor inside the enclosure measures ambient temperature. The microprocessor automatically compensates for speed-of-sound changes caused by air temperature fluctuations.

2.2 Transducer Operation

Several times a second, the ultrasonic level sensor emits a pulse. Between pulses the transducer becomes a receiver, ready to sense the echo reflected from the surface of the liquid. When the transducer receives the echo, the sound energy creates a small electrical pulse that is amplified and detected by the module. The time between the transmitted pulse and the received signal is proportional to the distance between the transmitter and the liquid surface. This distance determines the liquid's level.

2.2.1 Validity Tests

The module checks the measured level for validity. If the sampler cannot obtain a valid reading from the module, after about one minute, the sampler assumes the reading has not changed and will continue.

2.2.2 Ambient Air Temperature Factor

The ultrasonic measurement technique used in the module is based on the speed of sound in air. Since the speed of sound in air varies with temperature (approximately 1% for 10°F variation), compensation must be provided. The ultrasonic level sensor accounts for air temperature variations.

2.2.3 Return Echo Amplifier Compensation

The strength of the echo depends on several factors, including the distance between the transducer and the liquid surface. As the distance increases between the transducer and the liquid surface, the gain of the echo amplifier increases with time to compensate for the decreasing signal strength of the echo. This type of amplifier, whose gain characteristic is based on a repeating time interval, is referred to as a ramp-gain amplifier.

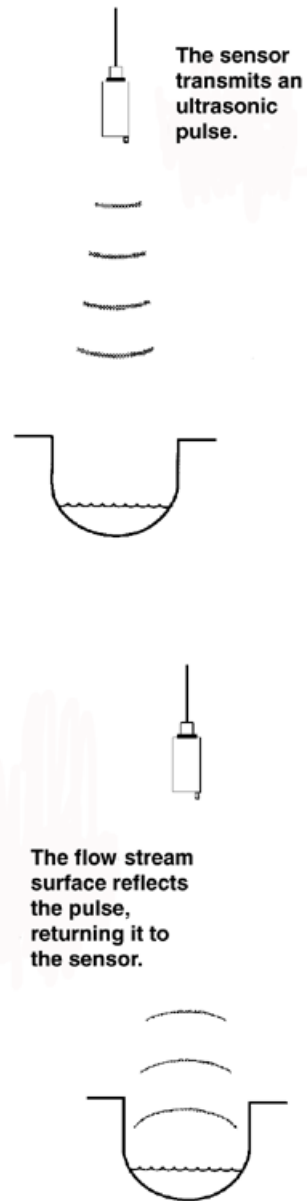

Figure 2-1 Ultrasonic Level Sensor Operation

2.3 Error Factors and Module Compensation

It is possible for the ultrasonic measurement system to be in error due to the influence of various factors on both the initial pulse and reflected sound wave. It is important that you understand these factors and take them into consideration when planning an installation. Proper installation will result in more accurate measurements. The factors affecting the ultrasonic system may be grouped broadly into two classes.

2.3.1 Velocity Errors

Velocity errors occur when the module is unable to accurately calculate the velocity of sound. Without going into the cause, it may be said that they are proportional errors, in that the error increases as the distance between the ultrasonic level sensor and the liquid surface increases.

2.3.2 Echo Detect Errors

Echo detect errors come from the problems the module may have measuring the time between transmitting the ultrasonic pulse and receiving the echo. Anything that can absorb or misdirect sound causes these errors. This makes the echo amplifier detect the returned signal either later or earlier than intended by the design of the ramp-gain amplifier. These errors will generally be of an absolute nature; they will not be affected to any extent by the distance between the transducer and the water.

2.3.3 Beam Angle

The module must only respond to surfaces within a specific area. The transducer can only “see” items inside a cone whose apex (point) is the ultrasonic transducer. The beam angle is the angle across this cone. If the beam angle is too wide, the module will detect unwanted surfaces, such as the walls of the channel. If the beam angle is too narrow, setup of the installation is difficult and the module may never detect an echo. The transducer has a beam angle of 10°.

2.3.4 Noise

Background noise can interfere with the operation of the module. The noise must be filtered out, or the module may trigger on noise rather than the echo. The module uses a tuned circuit to filter unwanted noise outside the system's frequency range (around 40 kHz). Software algorithms eliminate most sporadic noise pulses occurring within the module's operating frequency range.

 **CAUTION**

Tests have shown that the 710 Module is affected by RF signals such as those from radio and TV station towers located nearby. If water levels on the sampler's display are changing sporadically, but the water level is stable, the instrument will have to be relocated away from the RF sources. Walkie talkies or cell phones should not be operated within 3 meters (10 feet) of the sampler for the same reason.

2.3.5 Surface Objects

Objects or foam floating on the surface of the flow stream can absorb or weaken the ultrasonic pulses. If the pulses are reduced enough there will be no echo.

2.3.6 Temperature

Temperature changes have a significant effect on the velocity of sound (approximately 7% between 32° and 104°F). Consequently, the module provides temperature compensation. There is a temperature sensor embedded in the housing of the ultrasonic level sensor.

2.3.7 Waves

Waves on the surface of the flow stream can deflect the sound energy so it does not return to the transducer. Waves can also cause the sound to return to the transducer by an indirect path. In the first case, the module will not receive an echo; in the second case, the additional time lapse will cause an echo error, indicated by an incorrect level reading. The module employs a software algorithm to reject occasional readings that deviate substantially from normal. However, if the waves are severe, the module will not function and will indicate a “no echo” condition.

2.3.8 Wavelength

You can determine the wavelength of sound by dividing the velocity of the sound by the frequency. The frequency of the module is about 40 kHz. The length of a 40 kHz sound wave is found by dividing 1,125 by 40,000 which is 0.02813 feet or 0.3375 inches.

Under ideal conditions it is possible to detect the same wave front of the returning echo. However, any noise or abnormal attenuation (excessive decrease) may cause the module to detect an earlier or a later wave. When the attenuation of the returned echo does not match the gain slope of the amplifier, the circuit will eventually detect a different cycle of the returned echo as the distance changes. The impact of this wave-detect error is determined by the wavelength. Higher frequencies (shorter wavelengths) produce smaller echo-detect errors. However, higher frequencies are absorbed more rapidly, decreasing the maximum distance that you can measure with the same amount of power. The frequency of 40 kHz was selected for the module as a suitable compromise.

Since the sound travels the distance twice (going and coming), the observed error is one-half of the wavelength or 0.014 foot. The module uses a rectified detect circuit that can detect either the positive or negative peak. This allows the module to limit the error of proper wave detection to increments of one-half wavelength. This error is 0.007 foot.

2.3.9 Wind

Wind can blow the sound away or significantly reduce the intensity of the returned echo. Narrow beam angles, advantageous for measuring small flow streams, are a disadvantage in this situation. Likewise, greater distances to the surface of the flow stream are more affected by wind.

2.3.10 Other Factors

Changes in barometric pressure provide no significant cause of error. Humidity causes only a slight variation to the velocity of sound (maximum 0.35% at 68°F). The module does not provide any compensation for humidity.

2.4 Minimizing Level Measurement Errors

In order to minimize measurement errors with the ultrasonic level sensor, the following precautions should be observed when installing the ultrasonic level sensor. These are listed in the approximate order of their significance.

2.4.1 Temperature Differences

Isco recommends that you install the ultrasonic level sensor where the temperature of the sensor housing can represent the air temperature throughout the distance measured. Avoid locations where the sensor will operate at a different temperature than the air between the level sensor and the flow stream.

Air temperature affects the speed of the transmitted pulse. The ultrasonic level sensor housing includes a sensor which provides temperature readings for the module. The module applies these readings to the level measurement calculation. If the temperature sensor does not provide an accurate reading, not only is the usefulness of temperature compensation defeated, but also a measurement error will be multiplied by the distance the pulse must travel.

When the module receives inaccurate temperature readings, level errors can be as great as 0.001 per foot for each degree of temperature difference. For example, with a distance of only two feet and a temperature difference of 35°F, the level error is:

$$\text{Level Error} = 0.001 \times 35 \times 2 = 0.070 \text{ foot}$$

(about 1 inch)

Sunlight is a common factor that may cause the sensor to misrepresent the ambient air temperature. Direct sunlight will warm the sensor housing to a temperature greater than the surrounding air. Other factors include temperature inversions and layers of air at different temperatures throughout the distance the pulse must travel. Inversions or layers can also cause an abnormal reduction in the strength of the ultrasonic pulse.

If the ultrasonic level sensor is installed outside and directly exposed to the sun, a sunshade should be installed. See the Accessories section in this manual for ordering information.

2.4.2 Avoid Wind

The ultrasonic level sensor should be installed in a location protected from air currents. Wind reduces the strength of the ultrasonic pulse and echo. This causes the module to have difficulty detecting the proper wave in the echo. In severe cases, it is possible for the module to lose the echo completely.

2.4.3 Excessive Distance

Although the ultrasonic level sensor cannot be mounted closer than twelve inches from the maximum level of the flow stream, it is recommended that the mounting be kept as close to the twelve inch limit as possible. The reason is that any error made by the module in calculating the velocity of sound in the air is multiplied by the distance from the level sensor to the surface of the flow stream. Minimizing the distance will minimize the error.

2.4.4 Calibration Temperature

Calibrate the level reading under temperature conditions as near as possible to those expected during operation. If the sensor has been moved through various temperatures before installation, you should allow it to stabilize before calibration.

For small changes of level, the error due to temperature is determined by the product of distance and temperature change. Calibrating at the same temperature as the operating temperature will minimize this error.

2.4.5 Water Condensation

The ultrasonic level sensor will not operate properly if water condenses on the transducer surface as a result of high ambient humidity. Some users have found that mounting the transducer horizontally and aiming it at a 45° angle reflector will keep water from collecting on the transducer's radiating surface.

2.4.6 Foam, Oil, and Turbulence

If the flow stream surface is absorbent (such as with foam) or very irregular (such as highly turbulent water), the ultrasonic echo may not be correctly reflected back to the ultrasonic level sensor. This can result in a false measurement or no measurement at all. If the foam is reflective, the system will detect the top of the foam rather than the liquid surface. Also, if grease or oil is floating on the flow stream surface, it will be detected rather than the liquid surface.

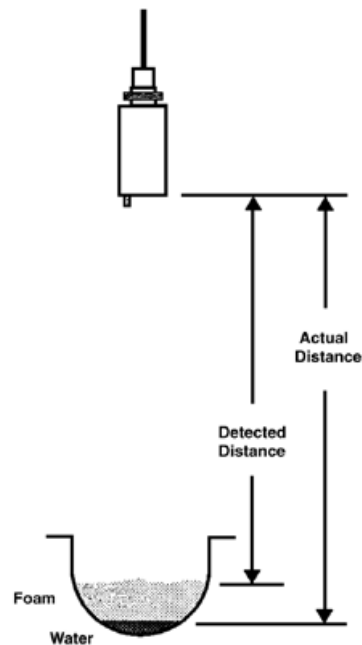

Figure 2-2 Foam and Oil on the Surface of the Flow Stream

2.4.7 Small Pipes and Channels

Small circular pipes, narrow channels, and small flumes may also cause problems with ultrasonic distance measurement. Since the ultrasonic pulse expands outward from the sensor at a beam angle of approximately 10° , it may strike the sides of a channel or the sloping sides of a circular pipe with low flow. This can result in false echoes and incorrect level readings. The term “small channels” generally refers to “U” shaped channels and pipe inverts $10''$ in diameter and less. The term “small flumes” generally refers to $1''$ and $2''$ Parshall flumes. It should be noted that the level measuring point for many types of flumes (Palmer Bowlus, Leopold-Lagco, etc.) is not in the flume, but upstream in the invert of the pipe. Thus, care should also be exercised in the use of $10''$ or smaller Palmer-Bowlus or Leopold-Lagco flumes.

The channel to be measured can be pre-qualified by a simple equation that will determine whether or not the channel is wide enough to allow correct positioning of the ultrasonic sensor. Since the beam angle is 10° , the equation is:

$$\text{Minimum Width} = 0.18 \times \text{Range}$$

Where range is the distance from the bottom of the ultrasonic level sensor to the minimum expected level.

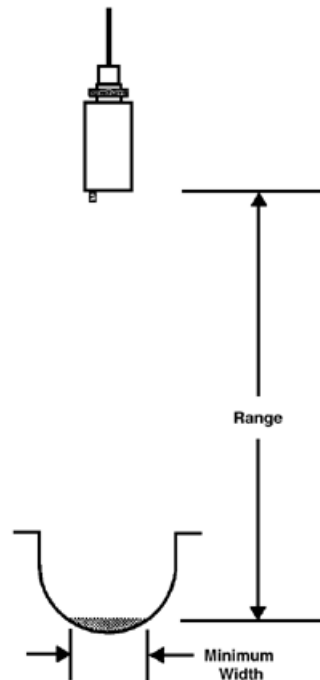

Figure 2-3 Small Pipes and Narrow Channels

**2.4.8 Alternative Flow
Measurement Systems**

Because of the characteristics of ultrasonic flow measurement, there may be some installations where the ultrasonic method is either unreliable or inaccurate. In these instances, it is worthwhile to consider using an alternate method of flow measurement.

In addition to the 710 Module, Isco offers three other types of plug-and-play flow modules in the 700 Series: the 730 Bubbler Module, the 720 Submerged Probe Module, and the 750 Area-Velocity Module.

Information about these flow modules is available from the factory. Call for more information or visit our Web site at www.isco.com.

710 Ultrasonic Module

Appendix A Accessories

Ultrasonic Sensor Cable Clamp – The cable clamp is used with the Spreader Bar to secure the mounting of the ultrasonic level sensor.

Ultrasonic Mounting Bracket – This device lets you install the ultrasonic level sensor on a convenient nearby wall over a flow stream.

Ultrasonic Transducer Mount – The transducer mount is a collapsible metal floor stand that you set up at the bottom of a manhole over a flow stream.

Ultrasonic Cable Straightener – The cable straightener is designed for use in installations where the transducer is suspended by its cable only. The straightener helps the transducer hang plumb.

Ultrasonic Calibration Target – This option is designed to make calibration of the level sensor more accurate during the installation process by letting you calibrate the level sensor from outside the manhole.

Ultrasonic Sunshade – The sunshade is a white plastic cap that fits over the top of the ultrasonic transducer. Its purpose is to keep sunlight from heating the transducer body.

710 Ultrasonic Module	68-6700-049
<i>(Includes module, Ultrasonic Level Sensor, and instruction manual)</i>	
Ultrasonic Level Sensor.	60-3214-025
Ultrasonic Level Sensor Mounting Bracket	60-2443-092
Ultrasonic Transducer Mount.	60-3004-117
Ultrasonic Cable Straightener	60-3213-061
Ultrasonic Level Sensor Cable Clamp	60-3004-129
Ultrasonic Sunshade	60-3004-142
Calibration Target	60-3004-143
Spreader Bar	60-3004-110

710 Ultrasonic Module

Appendix B Technical Specifications

Table B-1 Technical Specifications for the 710 Module	
Module Weight	1.1 lbs (0.5 kg)
Transducer Weight	2.1 lbs. (1.0 kg) (transducer and cable)
Module Dimensions	4.9 x 5.7 x 2.0 inches (12.4 x 14.5 x 5.1 cm)
Transducer Dimensions	2.3 inches diameter x 6 inches long (5.7 x 15.2 cm) 25 foot cable (7.6 m)
Module Material	Polystyrene
Transducer Materials	Delrin [®] housing with PVC cable
Operating Temperature	32° to 120°F (0° to 49°C)
Storage Temperature	0° to 140°F (-18° to 60°C)
Module Enclosure	NEMA 4X and 6, IP67
Transducer Enclosure	Totally encapsulated: NEMA 4X and 6, IP67
Power	Provided by the sampler
Memory	Nonvolatile programmable Flash Can be field updated through the sampler
Readings	Programmable through sampler at 1, 2, 5, 10, 15, and 30 minute intervals
Level Resolution	0.013 ft (0.4 cm) [per count of digital timer]
Level Measurement Accuracy	A change of less than 1 foot (30.5 cm): ±0.02 ft (±0.6 cm) at 72°F(22°C) A change of 1 to 10 feet (30.5 to 305 cm): ±0.04 ft (±1.2 cm) at 72°F(22°C) The change is relative to the calibration level.
Maximum Error Due to Temperature	±0.000085 x (Distance to liquid surface) per °C ±0.000047 x (Distance to liquid surface) per °F
Beam Angle	10 degrees
Range	Minimum 1 foot (30.5 cm) from sensor to liquid at maximum level. Maximum 11 feet 335 cm) from sensor to liquid at minimum level.
All weights may vary by ±0.2 lb (0.1 kg) All lengths may vary by ±0.25 inch (0.64 cm)	

DECLARATION OF CONFORMITY

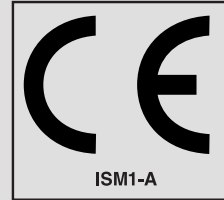

Application of Council Directive: 89/336/EEC – The EMC Directive
73/23/EEC – The Low Voltage Directive

Manufacturer's Name: Teledyne Isco, Inc.
Manufacturer's Address: 4700 Superior, Lincoln, Nebraska 68504 USA
Mailing Address: P.O. Box 82531, Lincoln, NE 68501

Equipment Type/Environment: Laboratory Equipment for Light Industrial/Commercial Environments
Trade Name/Model No: 710 ultrasonic module
Year of Issue: 2001

Standards to which Conformity is Declared: EN 61326-1998 EMC Requirements for Electrical Equipment for Measurement, Control, and Laboratory Use
EN 61010-1 Safety Requirements for Electrical Equipment for Measurement, Control, and Laboratory Use

Standard	Description	Severity Applied	Performance Criteria
EN61000-4-2	Electrostatic Discharge	Level 2 - 4kV contact discharge Level 3 - 8kV air discharge	B B
EN61000-4-3 *	Radiated RF Immunity	80 MHz to 1000MHz 80% AM at 1kHz Level 1 – 10V/m	A
EN61000-4-4	Electrical Fast Transient	Level 2 - 2kV on ac lines	B
EN61000-4-5	Surge on AC Lines	2kV common mode, 1KV differential mode	B
EN61000-4-6 *	Conducted RF on AC lines	150 kHz to 80 MHz, 3V rms, 80% modulated	B
EN61000-4-11	Voltage Dips/Short Interruptions	0.5 cycle, each polarity/100%	B
CISPR11/ EN 55011	RF Emissions	Group 1, Class A Industrial, Scientific, and Medical Equipment	
EN61000-3-2, 3-3	Harmonic, Flicker		

* Instrument is susceptible to 10V/M from 80MHz to 1000MHz and 3V rms from 150KHz to 80MHz
We, the undersigned, hereby declare that the design of the equipment specified above conforms to the above Directive(s) and Standards as of March 6, 2001.

William Foster
USA Representative



William Foster
Director of Engineering
Teledyne Isco, Inc.
4700 Superior Street
Lincoln, Nebraska 68504

Phone: (402) 464-0231
Fax: (402) 464-4543

60-9002-070
Rev. A

Teledyne Isco One Year Limited Factory Service Warranty *

Teledyne Isco warrants covered products against failure due to faulty parts or workmanship for a period of one year (365 days) from their shipping date, or from the date of installation by an authorized Teledyne Isco Service Engineer, as may be appropriate.

During the warranty period, repairs, replacements, and labor shall be provided at no charge. Teledyne Isco's liability is strictly limited to repair and/or replacement, at Teledyne Isco's sole discretion.

Failure of expendable items (e.g., charts, ribbon, tubing, lamps, glassware, seals and filters), or from normal wear, accident, misuse, corrosion, or lack of proper maintenance, is not covered. Teledyne Isco assumes no liability for any consequential damages.

Teledyne Isco specifically disclaims any warranty of merchantability or fitness for a particular purpose.

This warranty applies only to products sold under the Teledyne Isco trademark and is made in lieu of any other warranty, written or expressed.

No items may be returned for warranty service without a return authorization number issued from Teledyne Isco.

This warranty does not apply to the following products: Process Analyzers, SFX 3560 SFE Extractor, 6100 VOC Sampler.

The warrantor is Teledyne Isco, Inc.
4700 Superior, Lincoln, NE 68504, U.S.A.

*** This warranty applies to the USA and countries where Teledyne Isco Inc. does not have an authorized dealer. Customers in countries outside the USA, where Teledyne Isco has an authorized dealer, should contact their Teledyne Isco dealer for warranty service.**

In the event of instrument problems, always contact the Teledyne Isco Service Department, as problems can often be diagnosed and corrected without requiring an on-site visit. In the U.S.A., contact Teledyne Isco Service at the numbers listed below. International customers should contact their local Teledyne Isco agent or Teledyne Isco International Customer Service.

Return Authorization

A return authorization number must be issued prior to shipping. Following authorization, Teledyne Isco will pay for surface transportation (excluding packing/crating) both ways for 30 days from the beginning of the warranty period. After 30 days, expense for warranty shipments will be the responsibility of the customer.

Shipping Address: Teledyne Isco, Inc. - Attention Repair Service
4700 Superior Street
Lincoln NE 68504 USA

Mailing address: Teledyne Isco, Inc.
PO Box 82531
Lincoln NE 68501 USA

Phone: Repair service: (800)775-2965 (lab instruments)
(800)228-4373 (samplers & flow meters)
Sales & General Information (800)228-4373 (USA & Canada)

Fax: (402) 465-3001

Email: service@isco.com **Web site:** www.isco.com



