

# 720 Submerged Probe Module

## Installation and Operation Guide



Part #60-9003-368  
Copyright © 1996. All rights reserved, Teledyne Isco, Inc.  
Revision E, May 8, 2007



## Foreword

This instruction manual is designed to help you gain a thorough understanding of the operation of the equipment. Teledyne Isco recommends that you read this manual completely before placing the equipment in service.

Although Teledyne Isco designs reliability into all equipment, there is always the possibility of a malfunction. This manual may help in diagnosing and repairing the malfunction.

If the problem persists, call or e-mail the Teledyne Isco Technical Service Department for assistance. Simple difficulties can often be diagnosed over the phone.

If it is necessary to return the equipment to the factory for service, please follow the shipping instructions provided by the Customer Service Department, including the use of the **Return Authorization Number** specified. **Be sure to include a note describing the malfunction.** This will aid in the prompt repair and return of the equipment.

Teledyne Isco welcomes suggestions that would improve the information presented in this manual or enhance the operation of the equipment itself.

**Teledyne Isco is continually improving its products and reserves the right to change product specifications, replacement parts, schematics, and instructions without notice.**

### Contact Information

#### *Customer Service*

Phone: (800) 228-4373 (USA, Canada, Mexico)  
(402) 464-0231 (Outside North America)  
Fax: (402) 465-3022  
Email: IscoCSR@teledyne.com

#### *Technical Service*

Phone: (800) 775-2965 (Analytical)  
(800) 228-4373 (Samplers and Flow Meters)  
Email: IscoService@teledyne.com

Return equipment to: 4700 Superior Street, Lincoln, NE 68504-1398

#### *Other Correspondence*

Mail to: P.O. Box 82531, Lincoln, NE 68501-2531  
Email: IscoInfo@teledyne.com  
Web site: www.isco.com



*General Warnings*

This product is often installed in confined spaces. Some examples of confined spaces are manholes, pipelines, digesters, and storage tanks. These spaces may become hazardous environments that can prove fatal for those unprepared. These spaces are governed by OSHA 1910.146 and require a permit before entering.

*Hazard Severity Levels*

This manual applies *Hazard Severity Levels* to the safety alerts. These three levels are described in the sample alerts below.

 **CAUTION**

Cautions identify a potential hazard, which if not avoided, may result in minor or moderate injury. This category can also warn you of unsafe practices, or conditions that may cause property damage.

 **WARNING**









Warnings identify a potentially hazardous condition, which if not avoided, could result in death or serious injury.

 **DANGER**

**DANGER – limited to the most extreme situations to identify an imminent hazard, which if not avoided, will result in death or serious injury.**

*Hazard Symbols*

The equipment and this manual use symbols used to warn of hazards. The symbols are explained below.

<b>Hazard Symbols</b>	
<b>Warnings and Cautions</b>	
	The exclamation point within the triangle is a warning sign alerting you of important instructions in the instrument's technical reference manual.
	The lightning flash and arrowhead within the triangle is a warning sign alerting you of "dangerous voltage" inside the product.
	Pinch point. These symbols warn you that your fingers or hands will be seriously injured if you place them between the moving parts of the mechanism near these symbols.
<b>Symboles de sécurité</b>	
	Ce symbole signale l'existence d'instructions importantes relatives au produit dans ce manuel.
	Ce symbole signale la présence d'un danger d'électocution.
	Risque de pincement. Ces symboles vous avertit que les mains ou les doigts seront blessés sérieusement si vous les mettez entre les éléments en mouvement du mécanisme près de ces symboles
<b>Warnungen und Vorsichtshinweise</b>	
	Das Ausrufezeichen in Dreieck ist ein Warnzeichen, das Sie darauf aufmerksam macht, daß wichtige Anleitungen zu diesem Handbuch gehören.
	Der gepfeilte Blitz im Dreieck ist ein Warnzeichen, das Sie vor "gefährlichen Spannungen" im Inneren des Produkts warnt.
	Vorsicht Quetschgefahr! Dieses Symbol warnt vor einer unmittelbar drohenden Verletzungsgefahr für Finger und Hände, wenn diese zwischen die beweglichen Teile des gekennzeichneten Gerätes geraten.

# 720 Submerged Probe Module

---

## *Table of Contents*

### **Section 1 Installation**

---

1.1 Introduction . . . . .	1-1
1.2 Connecting to the Sampler . . . . .	1-2
1.3 Installation Checklist . . . . .	1-2
1.4 Determining the Probe Mounting Location . . . . .	1-3
1.5 Considerations Before Installing . . . . .	1-3
1.6 Maximum Installation Distances . . . . .	1-3
1.6.1 Extension Cables . . . . .	1-3
1.6.2 Quick Disconnect Box . . . . .	1-4

### **Section 2 Programming the Module**

---

2.1 Module Screens . . . . .	2-1
2.2 Programmed Enable . . . . .	2-1
2.3 Data Storage . . . . .	2-1
2.3.1 Recovering Module Data . . . . .	2-1
2.4 Flow Conversions . . . . .	2-7
2.5 Alternative Flow Measurement Systems . . . . .	2-7

### **Section 3 About the Submerged Probe**

---

3.1 Principles of Submerged Probe Operation . . . . .	3-1
3.1.1 Functionality Under Solids . . . . .	3-1
3.1.2 Minimum Reliable Detection Level . . . . .	3-2
3.2 Submerged Probe Nose Sections . . . . .	3-2
3.2.1 Attaching the Nose Section . . . . .	3-3

### **Section 4 Probe Installation Methods**

---

4.1 General Mounting Considerations . . . . .	4-1
4.2 Circular Channels . . . . .	4-2
4.2.1 Spring Rings . . . . .	4-2
4.2.2 Scissors Rings . . . . .	4-5
4.3 Other Mounting Techniques . . . . .	4-6
4.3.1 Rectangular and Trapezoidal Channels . . . . .	4-6
4.3.2 Stilling Wells or Streams with Very Low Velocity . . . . .	4-7
4.3.3 Securing Probe with a Weighted Plate . . . . .	4-7
4.3.4 Weirs and Flumes . . . . .	4-7
4.4 Completing the Probe Installation . . . . .	4-9

### **Section 5 Module and Probe Maintenance**

---

5.1 Cleaning the Submerged Probe . . . . .	5-1
5.2 Desiccant Reactivation . . . . .	5-2
5.3 Flash Memory and Software Upgrades . . . . .	5-3

## Appendix A Replacement Parts List

---

## Appendix B Technical Specifications

---

## Appendix C Material Safety Data Sheets

---

C.1 Overview .....	C-1
--------------------	-----

## List of Figures

---

1-1 720 Module mounted on sampler .....	1-1
1-2 Quick Disconnect Box (Cover Removed) .....	1-4
1-3 Typical Probe Installation Methods .....	1-5
2-1 Summary Report .....	2-2
2-2 Combined Report (A) and Settings Report (B) .....	2-3
2-3 Sampler Programming: 720 Module Screens .....	2-4
2-4 Sampler Programming: 720 Module Set Up Screens .....	2-5
2-5 Sampler Programming: 720 Module Quick View Screens .....	2-6
3-1 Submerged Probe Dimensions .....	3-1
3-2 Alignment of Grounding Point .....	3-3
4-1 Sensor Installed on a Spring Ring .....	4-3
4-2 Spring Ring Preparation .....	4-4
4-3 Mounting Ring in a Round Pipe .....	4-4
4-4 Universal Mounting Ring Adjustment .....	4-6
4-5 Isco Rectangular Mounting Plate .....	4-6
4-6 Typical Primary Device Installations .....	4-8
5-1 Grounding Point and Mounting Hole Alignment .....	5-2

## List of Tables

---

2-1 Flow Conversion Methods .....	2-7
4-1 Locating the Head-Measuring Point .....	4-7
A-1 Replacement Parts and Accessories .....	A-1
B-1 Technical Specifications for the 720 Submerged Probe Module .....	B-1
B-2 Technical Specifications for the Submerged Probe .....	B-1



# 720 Submerged Probe Module

## *Section 1 Installation*

### **1.1 Introduction**

The 720 Submerged Probe Module is one of Teledyne Isco's interchangeable modules for the Avalanche and 6700 Series Samplers. The module enhances sampler operation by providing flow-pacing and additional sampler enable conditions. The sampler also displays the real-time level, flow rate, and total flow provided by the module. The sampler records the data for later analysis.

The module uses a differential pressure transducer to measure level. The submerged probe is usually installed with some type of primary measuring device, such as a weir or flume.



*Figure 1-1 720 Module mounted on sampler*

## 1.2 Connecting to the Sampler

To install the module:

1. Turn the sampler off.
2. Remove the connector cap in the module bay and move it aside.
3. Slide the module into the bay.
4. Gently push against the module to be sure the connector is fully seated.

To remove the module:

1. Turn the sampler off.
2. Press the silver button on top of the module and pull the module from the bay.
3. Replace the connector cap in the module bay.

### **WARNING**

**The module has not been approved for use in hazardous locations as defined by the National Electrical Code. Installation of this module in a hazardous location may cause fire or explosion resulting in death, personal injury, or property damage. Before installing any device in a dangerous location, review safety precautions in your sampler manual. Check applicable guidelines, codes, and regulations of federal, state, city, and county agencies.**

## 1.3 Installation Checklist

Installation Checklist:

1. Check the desiccant cartridge. Make sure the desiccant is active (blue or yellow in color) and remove the red cap.
2. Install the module and turn the sampler on.
3. Install the submerged probe in the channel.
4. Connect the submerged probe's cable to the module.
5. Program the sampler and calibrate the module's level reading.
6. Set up the sampler. See details in the sampler manual.
7. Run the program.

### **Note**

You should install the module before turning the controller on. When the controller is turned on, it looks for a module. The controller will not recognize a newly installed module if it is not seen during this power-up routine. If you install a module while the controller is already on, turn the controller off and then on again to reconfigure the controller for use with the module.

## 1.4 Determining the Probe Mounting Location

The location of the submerged probe depends on the method of level-to-flow rate conversion you are using. The probe is usually installed with some type of primary measuring device, such as a weir or flume. Most primary devices have a specific place for the head (level) measurement device. For example, the head measuring point of a weir is at least three times the expected maximum head upstream from the weir plate. For Parshall flumes, the measuring point is  $\frac{1}{3}$  of the way into the converging section.

If you intend to measure flow by some other means, such as a gravity flow equation (Manning) or by calibrating a section of the flow channel (Data Points), you will have to determine the best location for the submerged probe. Select a location with hydraulic characteristics that are suitable for the method of level-to-flow rate conversion.

For more details about the location of the head measuring point, refer to the *Isco Open Channel Flow Measurement Handbook*, or to information provided by the manufacturer of the primary device. For a list of available level-to-flow conversions, see Section 2, Table 2-1.

## 1.5 Considerations Before Installing

The probe cable must be routed and secured so it does not collect debris.

When installing the probe in a pipe or invert, mount the probe upstream from the outfall. Install the probe where liquid will cover the entire probe. The minimum level is approximately 0.1 foot (1.2 inch or 3.0 cm). The submerged probe can measure levels less than 0.08 feet (1 inch or 2.5 cm); however, accuracy in this range is **not** guaranteed.

The level can be calibrated with the probe mounted at nearly any depth. Operation will be unaffected as long as the liquid covers the probe. This allows you to install the probe offset from the bottom, which has several advantages:

- Avoidance of heavy concentrations of silt, sand, or other solids.
- Aid in installation in narrow or hard-to-reach locations.
- Maximization of level resolution over a specific level range.
- Avoidance of obstructions in the flow stream.

The submerged probe can still measure level when covered with silt and sand, as long as pressure gets through.

## 1.6 Maximum Installation Distances

For probe location at distances exceeding 25 feet from the sampler and module, Teledyne Isco provides special equipment.

### 1.6.1 Extension Cables

To locate the probe more than 25 feet away from the sampler and module, use Teledyne Isco's vented 25 or 50 foot extension cables. You can combine vented extension cables, as long as the total cable length does not exceed 75 feet.

- 1.6.2 Quick Disconnect Box** To locate the probe more than 75 feet from the sampler and module, use the Submerged Probe Quick Disconnect Box. The box increases the maximum distance between the module and the probe to 1,000 feet.

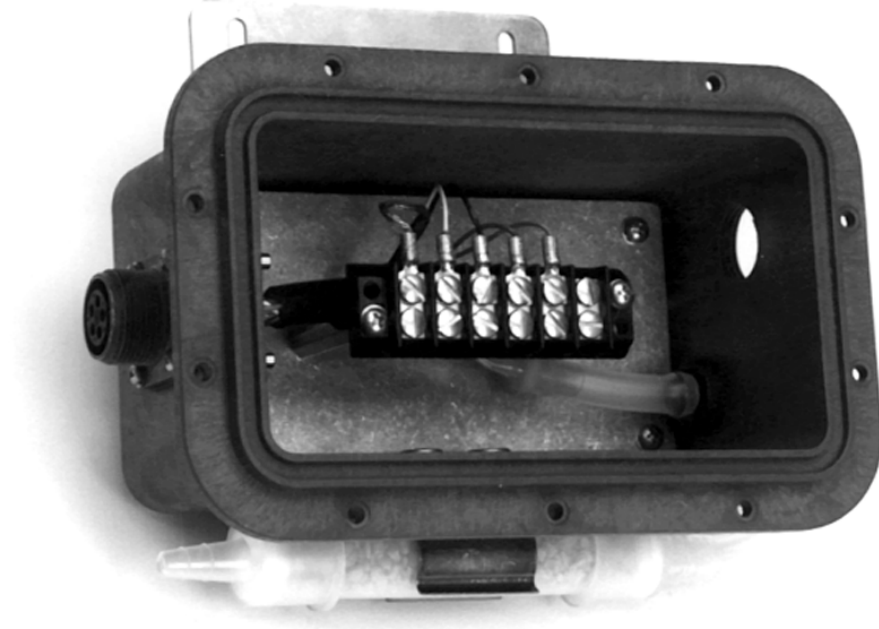

Figure 1-2 Quick Disconnect Box (Cover Removed)

**⚠ WARNING**

Mounting hardware may have sharp edges. Cuts and abrasions are possible. Injuries from hardware contaminated by sewage may also become infected. To avoid these hazards:

**Wear leather gloves when handling the hardware.**  
**Clean the mounting hardware between installations.**

**⚠ CAUTION**

Abusive handling will damage the pressure transducer inside the probe. Although the submerged probe will survive normal handling and installation, treat it with reasonable care.

The vent tube inside the cable **must** remain open. Do not kink the cable, overtighten the plastic ties while securing the cable, or allow any moisture to enter the vent via the connector.

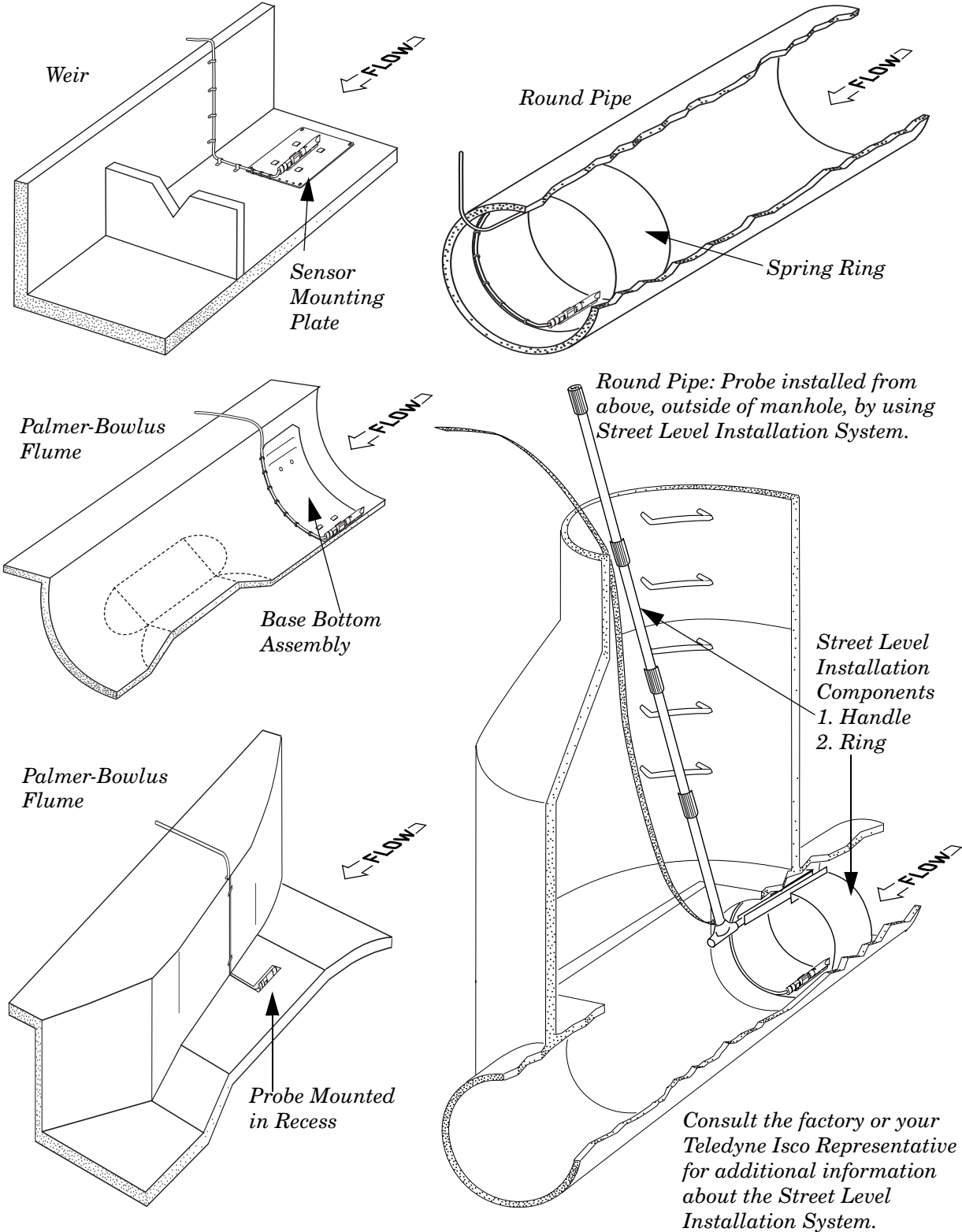

Figure 1-3 Typical Probe Installation Methods



# 720 Submerged Probe Module

---

## Section 2 Programming the Module

### 2.1 Module Screens

When the controller is configured with the module, it adds the necessary screens for programming. The screens appear on the following pages in Figures 2-3, 2-4, and 2-5. These figures outline the steps for module programming and calibration. For 6700 or 6712 programming and general programming information, see the sampler manual.

#### **Note**

An \* (asterisk) appears next to a reading if the module was unable to take a reading. If an \* appears, the reading displayed is the last available reading.

See Table 2-1 for flow conversion types.

### 2.2 Programmed Enable

When the 720 Module is installed, additional sampler enable options are available. If programmed for LEVEL ONLY, the option will be LEVEL. If programmed for FLOW METER, the options will be LEVEL and FLOW. For more information about programmed enables, see *Sampler Enable* in the sampler manual.

### 2.3 Data Storage

When the sampler is configured for use with the module, a memory partition is reserved. The module readings are stored in this sampler memory partition. For more information on data storage and partition management, please refer to your 6700 series sampler instruction manual.

#### 2.3.1 Recovering Module Data

The stored module data can be collected or viewed as “reports.” Three of the sampler reports can contain module information. Please refer to your 6700 series sampler instruction manual for collecting and reading the reports.

720 Submerged Probe Module  
 Section 2 Programming the Module

---

Flow Summary - 14 JUN-02 (FR)

Flow at "FACTORY " Site  
 On 14-JUN-02

SUBMERGED PROBE: 638324458  
 Day's Flow: 0.678964 Mgal  
 Average Flow Rate: 3.466 cfs  
 12:45 Maximum Flow Rate: 6.689 cfs  
 14:49 Minumum Flow Rate: 1.442 cfs

Hourly Average Flow Rate:

00:00-01:00:	NO DATA	12:00-13:00:	5.385 cfs
01:00-02:00:	NO DATA	13:00-14:00:	6.651 cfs
02:00-03:00:	NO DATA	14:00-15:00:	2.591 cfs
03:00-04:00:	NO DATA	15:00-16:00:	1.593 cfs
04:00-05:00:	NO DATA	16:00-17:00:	END DATA
05:00-06:00:	NO DATA	17:00-18:00:	NO DATA
06:00-07:00:	NO DATA	18:00-19:00:	NO DATA
07:00-08:00:	BEGIN DATA	19:00-20:00:	NO DATA
08:00-09:00:	2.519 cfs	20:00-21:00:	NO DATA
09:00-10:00:	2.747 cfs	21:00-22:00:	NO DATA
10:00-11:00:	2.791 cfs	22:00-23:00:	NO DATA
11:00-12:00:	3.456 cfs	23:00-24:00:	NO DATA

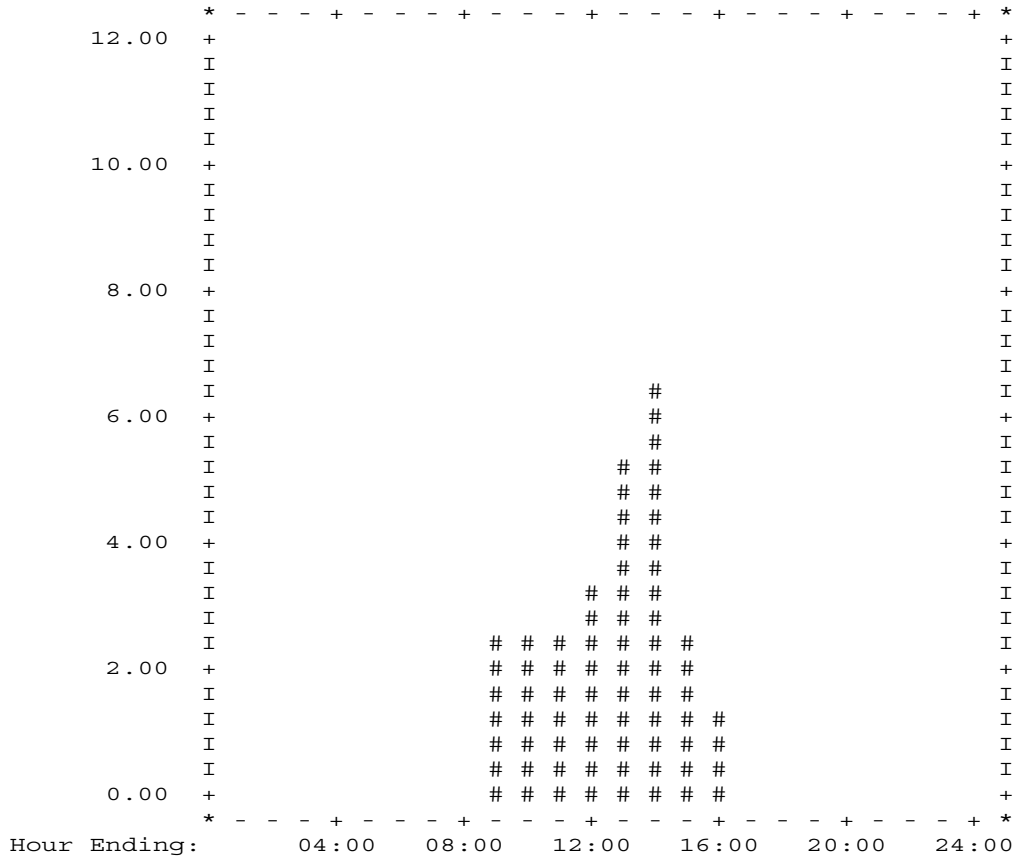

Units are 'cfs'

Figure 2-1 Summary Report



<p>SAMPLER ID# 11343009 15:25 14 JUN 02  SUBMERGED PROBE: 638324458  ***** COMBINED RESULTS *****  SITE: FACTORY  Program Started at 08:41 FR 14 JUN 02  Nominal Sample Volume = 200 ml</p> <table border="0" style="width: 100%; border-collapse: collapse;"> <thead> <tr> <th style="text-align: left;">SAMPLE</th> <th style="text-align: left;">BOTTLE</th> <th style="text-align: left;">TIME</th> <th style="text-align: left;">FLOW RATE cfs</th> <th style="text-align: left;">TOTAL FLOW Mgal</th> </tr> </thead> <tbody> <tr><td>1</td><td>1</td><td>08:41</td><td>2.495</td><td>0.000000</td></tr> <tr><td>1</td><td>2</td><td>08:56</td><td>2.576</td><td>0.016941</td></tr> <tr><td>1</td><td>3</td><td>09:11</td><td>2.666</td><td>0.034698</td></tr> <tr><td>1</td><td>4</td><td>09:26</td><td>2.773</td><td>0.052914</td></tr> <tr><td>1</td><td>5</td><td>09:41</td><td>2.773</td><td>0.071707</td></tr> <tr><td>1</td><td>6</td><td>09:56</td><td>2.798</td><td>0.090520</td></tr> <tr><td>1</td><td>7</td><td>10:11</td><td>2.798</td><td>0.109314</td></tr> <tr><td>1</td><td>8</td><td>10:26</td><td>2.798</td><td>0.128112</td></tr> <tr><td>1</td><td>9</td><td>10:41</td><td>2.751</td><td>0.146911</td></tr> <tr><td>1</td><td>10</td><td>10:56</td><td>2.773</td><td>0.165698</td></tr> <tr><td>1</td><td>11</td><td>11:11</td><td>2.798</td><td>0.184556</td></tr> <tr><td>1</td><td>12</td><td>11:26</td><td>3.728</td><td>0.206933</td></tr> <tr><td>1</td><td>13</td><td>11:41</td><td>3.728</td><td>0.232024</td></tr> <tr><td>1</td><td>14</td><td>11:56</td><td>3.728</td><td>0.257108</td></tr> <tr><td>1</td><td>15</td><td>12:11</td><td>3.728</td><td>0.282171</td></tr> <tr><td>1</td><td>16</td><td>12:26</td><td>5.273</td><td>0.317318</td></tr> <tr><td>1</td><td>17</td><td>12:41</td><td>5.239</td><td>0.352755</td></tr> <tr><td>1</td><td>18</td><td>12:56</td><td>6.651</td><td>0.396903</td></tr> <tr><td>1</td><td>19</td><td>13:11</td><td>6.651</td><td>0.441689</td></tr> <tr><td>1</td><td>20</td><td>13:26</td><td>6.651</td><td>0.486476</td></tr> <tr><td>1</td><td>21</td><td>13:41</td><td>6.651</td><td>0.531238</td></tr> <tr><td>1</td><td>22</td><td>13:56</td><td>6.651</td><td>0.575999</td></tr> <tr><td>1</td><td>23</td><td>14:11</td><td>3.404</td><td>0.611500</td></tr> <tr><td>1</td><td>24</td><td>14:26</td><td>3.425</td><td>0.634426</td></tr> </tbody> </table> <p style="text-align: center; margin-top: 20px;">A</p>	SAMPLE	BOTTLE	TIME	FLOW RATE cfs	TOTAL FLOW Mgal	1	1	08:41	2.495	0.000000	1	2	08:56	2.576	0.016941	1	3	09:11	2.666	0.034698	1	4	09:26	2.773	0.052914	1	5	09:41	2.773	0.071707	1	6	09:56	2.798	0.090520	1	7	10:11	2.798	0.109314	1	8	10:26	2.798	0.128112	1	9	10:41	2.751	0.146911	1	10	10:56	2.773	0.165698	1	11	11:11	2.798	0.184556	1	12	11:26	3.728	0.206933	1	13	11:41	3.728	0.232024	1	14	11:56	3.728	0.257108	1	15	12:11	3.728	0.282171	1	16	12:26	5.273	0.317318	1	17	12:41	5.239	0.352755	1	18	12:56	6.651	0.396903	1	19	13:11	6.651	0.441689	1	20	13:26	6.651	0.486476	1	21	13:41	6.651	0.531238	1	22	13:56	6.651	0.575999	1	23	14:11	3.404	0.611500	1	24	14:26	3.425	0.634426	<p>SAMPLER ID# 11343009 15:25 15-SEP-03  ***** PROGRAM SETTINGS *****</p> <p>-----  SITE DESCRIPTION:  "FACTORY "  -----  UNITS SELECTED:  LENGTH: ft  -----  UNITS SELECTED:  FLOW RATE: cfs  FLOW VOLUME: Mgal  -----  SUBMERGED PROBE:  WEIR  90  V-NOTCH  -----  1 MINUTE  DATA INTERVAL  -----  24, 1000 ml BTLS  10 ft SUCTION LINE  -----  PACING:  TIME, EVERY  0 HOURS, 15 MINUTES  -----  DISTRIBUTION:  SEQUENTIAL  200 ml SAMPLES  -----  5 MINUTE DELAY TO  FIRST SAMPLE  RUN PROGRAM ONCE  -----</p> <p style="text-align: center; margin-top: 20px;">B</p>
SAMPLE	BOTTLE	TIME	FLOW RATE cfs	TOTAL FLOW Mgal																																																																																																																										
1	1	08:41	2.495	0.000000																																																																																																																										
1	2	08:56	2.576	0.016941																																																																																																																										
1	3	09:11	2.666	0.034698																																																																																																																										
1	4	09:26	2.773	0.052914																																																																																																																										
1	5	09:41	2.773	0.071707																																																																																																																										
1	6	09:56	2.798	0.090520																																																																																																																										
1	7	10:11	2.798	0.109314																																																																																																																										
1	8	10:26	2.798	0.128112																																																																																																																										
1	9	10:41	2.751	0.146911																																																																																																																										
1	10	10:56	2.773	0.165698																																																																																																																										
1	11	11:11	2.798	0.184556																																																																																																																										
1	12	11:26	3.728	0.206933																																																																																																																										
1	13	11:41	3.728	0.232024																																																																																																																										
1	14	11:56	3.728	0.257108																																																																																																																										
1	15	12:11	3.728	0.282171																																																																																																																										
1	16	12:26	5.273	0.317318																																																																																																																										
1	17	12:41	5.239	0.352755																																																																																																																										
1	18	12:56	6.651	0.396903																																																																																																																										
1	19	13:11	6.651	0.441689																																																																																																																										
1	20	13:26	6.651	0.486476																																																																																																																										
1	21	13:41	6.651	0.531238																																																																																																																										
1	22	13:56	6.651	0.575999																																																																																																																										
1	23	14:11	3.404	0.611500																																																																																																																										
1	24	14:26	3.425	0.634426																																																																																																																										

Figure 2-2 Combined Report (A) and Settings Report (B)

720 Submerged Probe Module  
 Section 2 Programming the Module

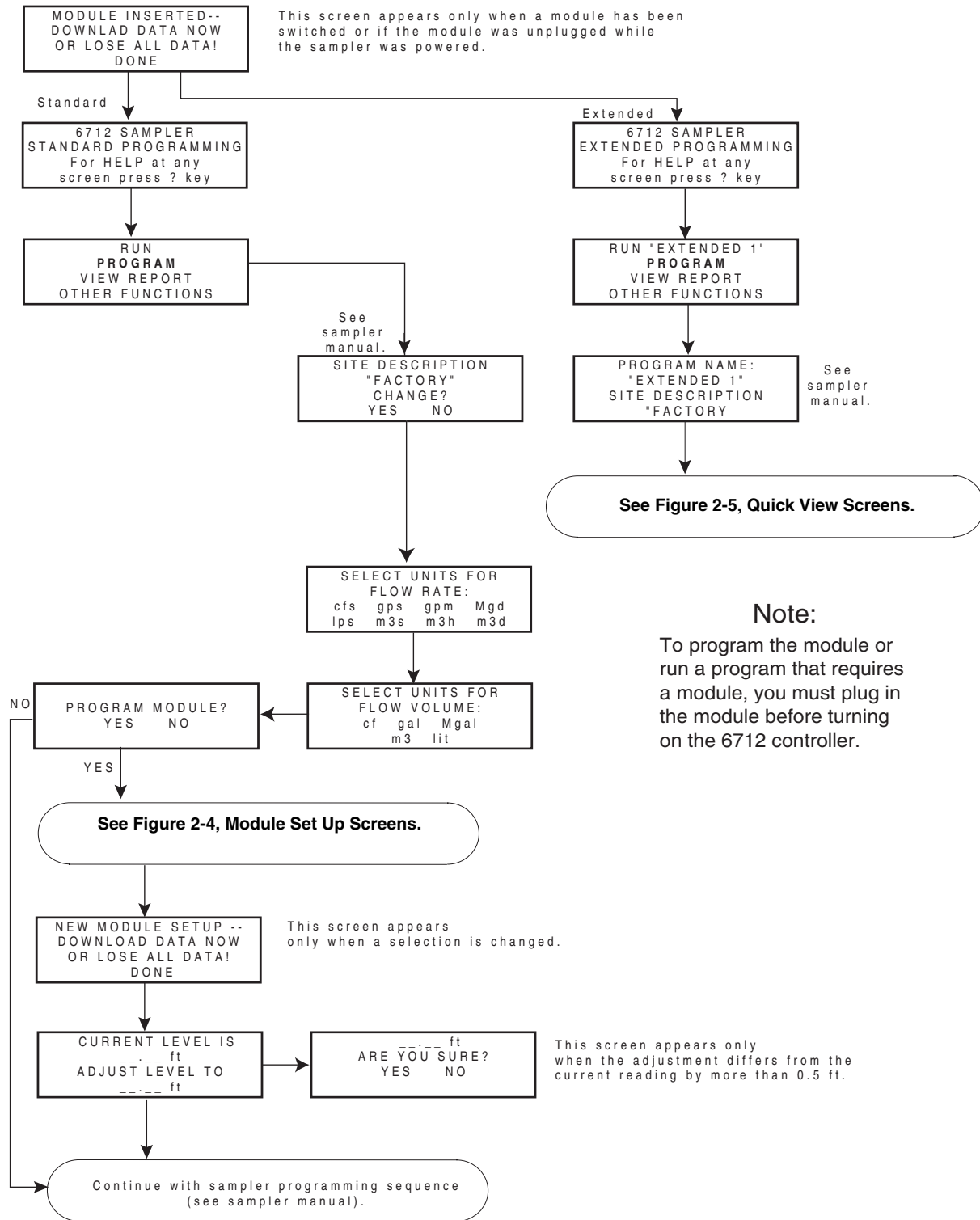

Figure 2-3 Sampler Programming: 720 Module Screens

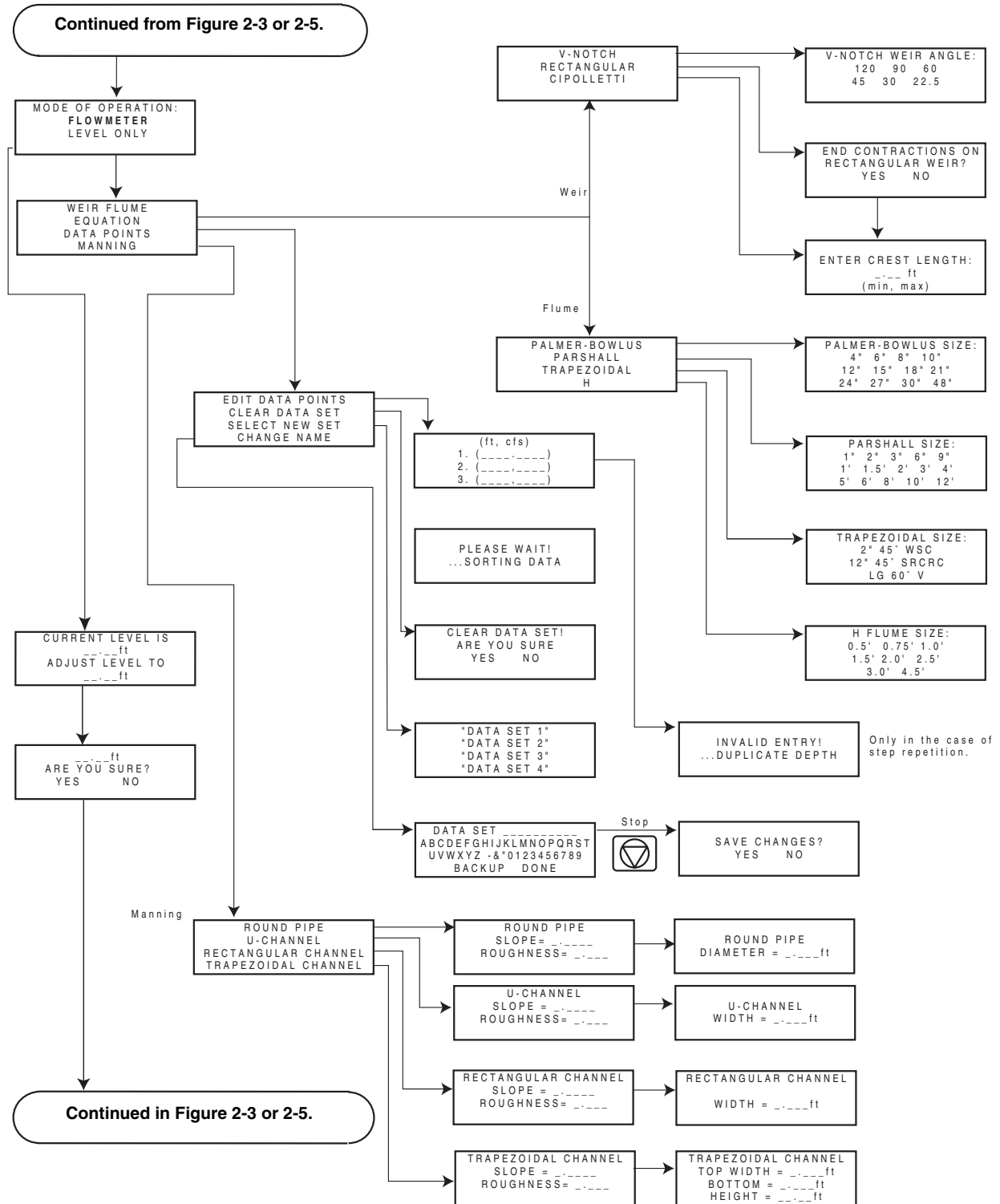

Figure 2-4 Sampler Programming: 720 Module Set Up Screens

720 Submerged Probe Module  
 Section 2 Programming the Module

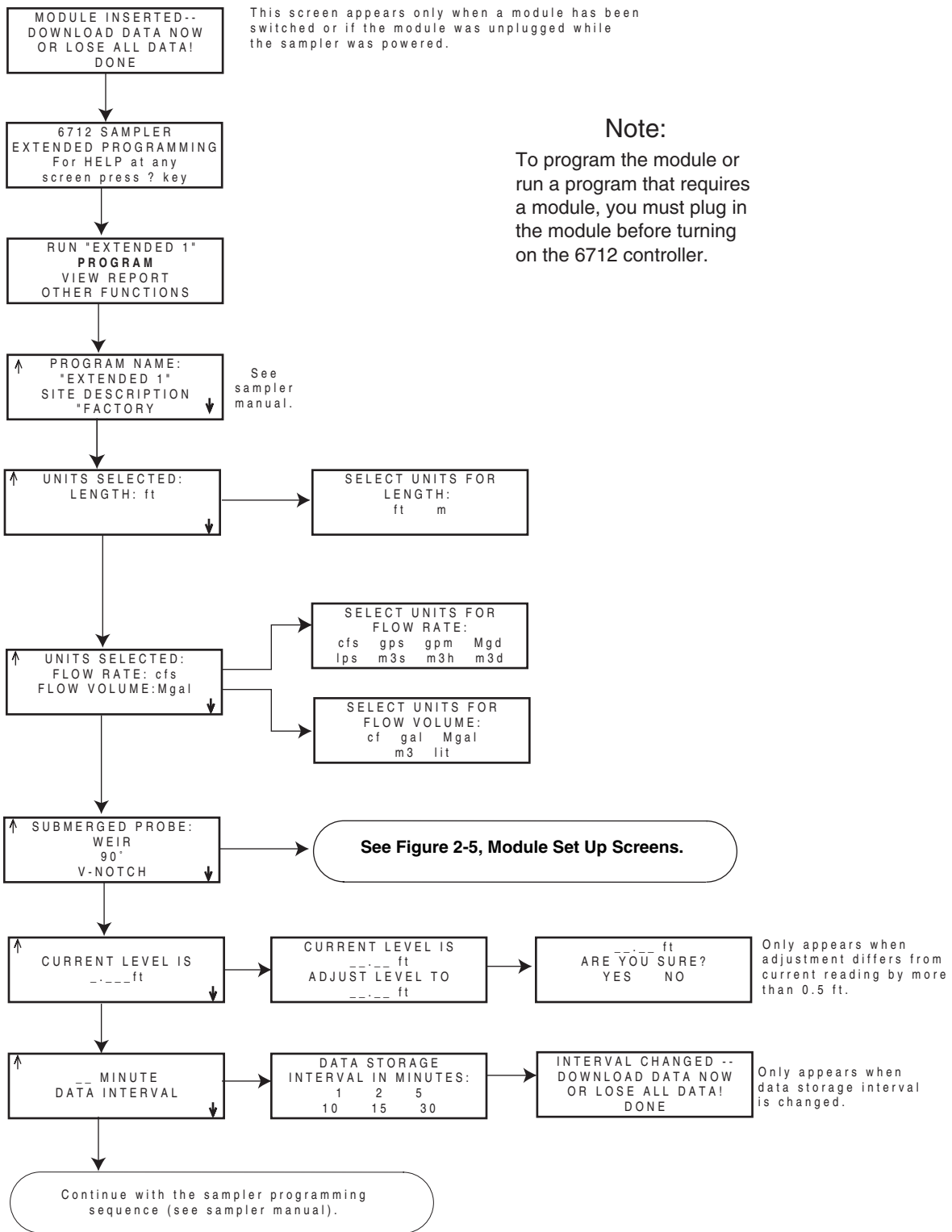

Figure 2-5 Sampler Programming: 720 Module Quick View Screens

## 2.4 Flow Conversions

The following table contains programming information for each conversion method.

Table 2-1 Flow Conversion Methods		
Conversion Type	Device, Formula, or Table	Size or Parameters
Weir	V- Notch Weir	22.5, 30, 45, 60, 90, 120 degrees.
	Rectangular Weir with End Contractions	Crest length.
	Rectangular Weir without End Contractions	Crest length.
	Cipoletti Weir	Crest length.
Flume	Palmer-Bowlus Flume	4, 6, 8, 10, 12, 15, 18, 21, 24, 27, 30, 48 inches.
	Parshall Flume	1, 2, 3, 6, 9 inches. 1, 1.5, 2, 3, 4, 5, 6, 8, 10, 12 feet.
	Trapezoidal Flume	Large 60-degree V. 2-inch, 45-degree WSC. 12-inch, 45-degree SRCRC.
	"H" Flume	0.5, 0.75, 1, 1.5, 2, 2.5, 3, 4.5 feet.
Equation	$Q = a \times H^{b+c} \times H^d$	Q = flow H = head a, b, c, & d = entered values
Data Points	User-developed tables for level-to-flow rate.	3 to 50 data points.
Manning Equation	Round Pipe	Slope, Roughness, Diameter.
	U-Channel Pipe	Slope, Roughness, Width.
	Rectangular Pipe	Slope, Roughness, Width.
	Trapezoidal	Slope, Roughness, Bottom Width, Top Width.

## 2.5 Alternative Flow Measurement Systems

Because of the characteristics of submerged probe flow measurement, there may be some installations where the submerged probe method is either unreliable or inaccurate. In these instances, it is worthwhile to consider using an alternate method of flow measurement.

In addition to the 720 Module, Teledyne Isco offers three other types of plug-and-play flow modules in the 700 Series: the 730 Bubbler Module, the 710 Ultrasonic Module, and the 750 Area-Velocity Module.

Information about these flow modules is available from the factory. Call for more information or visit our Web site at [www.isco.com](http://www.isco.com).



# 720 Submerged Probe Module

## Section 3 About the Submerged Probe

### 3.1 Principles of Submerged Probe Operation

The submerged probe contains an internal differential pressure transducer. The transducer detects pressure with a stainless steel diaphragm that transfers pressure to a piezo-resistive disk. The outer face of the diaphragm is exposed to the pressure of the flow stream through ports around the outside of the probe. The inner face is exposed, or referenced, to the atmosphere through an internal vent tube that runs the full length of the probe's cable. The difference between the pressures exerted on the diaphragm is the hydrostatic pressure. The transducer converts the hydrostatic pressure to analog signals. The signals are sent to the module through an amplifier.

Because pressure is proportional to the level of the stream, the 720 Module can convert the analog signal to level readings. The level readings, in turn, are converted to flow rates with level-to-flow-rate conversion formulas, or tables characteristic of the primary device at the site.

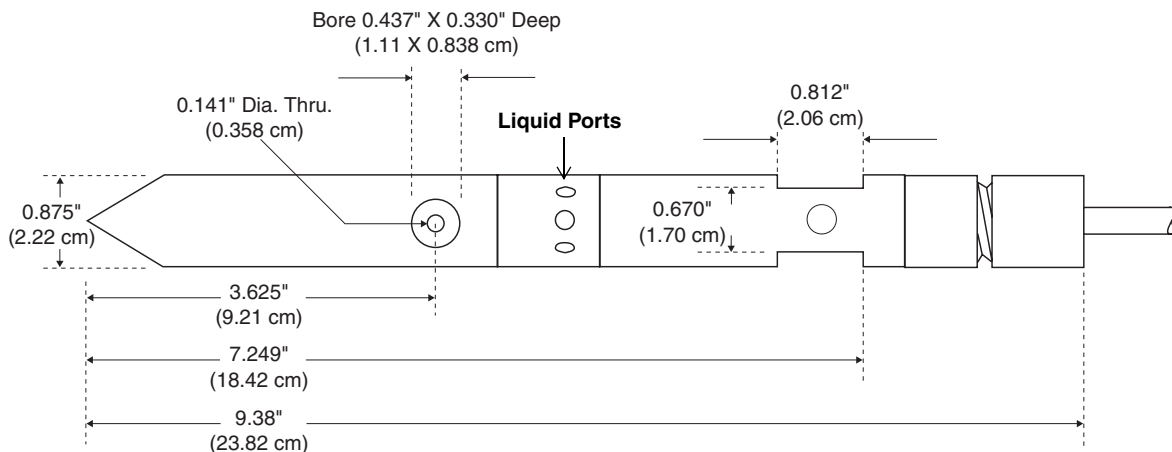

Figure 3-1 Submerged Probe Dimensions

#### 3.1.1 Functionality Under Solids

Consequently, the probe will normally continue to function even when covered with several inches of silt or sand. Note however, that porous solids, such as wood chips or other organic material that may swell considerably when soaked in water, can interfere with the correct operation of the pressure transducer. In extreme cases, swelling material can put enough pressure on the diaphragm of the pressure transducer to deform it. This will ruin the submerged probe by introducing a permanent offset to the pressure transducer.

**Note**

Always install the probe where it will be under water, even if only an inch or so. The probe cannot measure levels that fall below its location in the stream.

### 3.1.2 Minimum Reliable Detection Level

It is important to note that there is a practical minimum water level below which the submerged probe cannot reliably measure level. This minimum level is approximately equal to the height of the probe body, 0.1 ft. (1.3 in. or 0.030 m).

Liquid levels lower than this will be below the levels used to calibrate the sensor. The submerged probe level sensor will continue to measure levels less than 0.1 ft.; however, the accuracy of the measurement in this range is not guaranteed. Consequently, you should always use the submerged probe with caution in very low flow situations.

## 3.2 Submerged Probe Nose Sections

Standard Nose Section

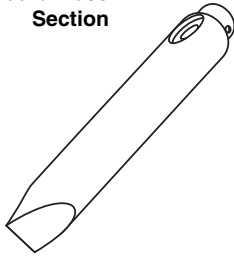

Slanted Nose Section

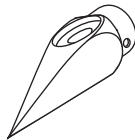

Flume Cap

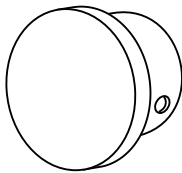

Teledyne Isco provides three nose sections, each designed for specific flow stream conditions.

A complete list of nose sections and their part numbers can be found in Appendix A.

**Standard Nose Section** – The standard nose section works in any flow stream and will be installed on your probe unless otherwise specified in your order. It is particularly well suited for flow streams with high velocities because its shape overcomes hydraulic problems that develop in these flow streams. At velocities exceeding 5 feet per second (1.5 meters per second), localized low-pressure areas form near the submerged probe, which can result in erroneous level readings. The length of the nose section (3.87 inches or 9.84 cm) minimizes low-pressure areas by allowing the flow stream to stabilize before it reaches the probe's entrance ports.

**Slanted Nose Section** – Under certain conditions - low flow rates in debris-laden small sewers, for example - the submerged probe may catch and retain the debris, obstructing the flow stream and causing erroneous level readings. To avoid this problem, use the slanted nose section. This nose section has a slanted leading edge that tends to shed debris more readily than the standard nose section.

Use the slanted nose section with caution, however, Under conditions of low flow and high velocity, the slanted nose section may induce a hydraulic “jump” in the flow stream that can cause erroneous level readings.

**Flume Cap** – The flume cap is a small, blunt cap that replaces the nose section. Most flume manufacturers can supply flumes with a small cavity to accept an Isco probe. The probe cap protects the transducer while minimizing the total length.



**3.2.1 Attaching the Nose  
Section**

After cleaning, reinstall the nose section and tighten the screws. **The mounting hole must be aligned with the grounding point.**



*Figure 3-2 Alignment of Grounding Point*



# 720 Submerged Probe Module

---

## *Section 4 Probe Installation Methods*

The following sections describe installation of the submerged probe. The first section presents general mounting considerations common to all submerged probe mounting techniques. The following sections describe probe installation using the two systems available for mounting the submerged probe in pipes or round-bottomed flow streams. For pipes up to 15 inches (38.1 cm) in diameter, spring stainless steel self-expanding mounting rings are available. For pipes larger than 15 inches in diameter, Teledyne Isco offers the **Scissors Ring**. For use in similarly-sized manhole inverts, you can use the **base** and **extension sections** of the Scissors Ring without the scissors section. The straps are held in place by studs installed in the wall of the flow stream using a power-activated stud gun. Submerged probes are also installed in primary measuring devices.

### 4.1 General Mounting Considerations

The location of the probe in the stream is usually dependent on the flow rate conversion used. For example, if you are using the probe with a primary measuring device (weir or flume), there is a *specific location* for the probe with each primary device. The *Isco Open Channel Flow Measurement Handbook* provides much useful information in this regard.

If you want to measure flow using a gravity flow equation, such as the Manning equation, you will generally install the probe in the entrance (upstream) pipe of a manhole. If you want to measure flow by calibrating a manhole invert, you would probably locate the probe directly in the manhole invert.

In any case, you must determine the appropriate location of the probe, based on the hydraulic characteristics of the site and the method of level-to-flow rate conversion used.

You do not have to install the submerged probe at the bottom of the flow stream. Although the bottom is the normal position, the Parameter to Adjust step in the program allows you to mount the probe at any vertical location in the stream, and then adjust the indicated level to match the actual level. (The 720 can indicate negative levels.)

A location other than the bottom of the flow stream may be useful for various reasons: to avoid heavy concentrations of silt, sand, or other solids; to make installation easier in tight locations; to maximize level resolution over a specific level range; to avoid hydraulic obstructions in the flow stream, etc.

The probe has several ports through which liquid enters the body to contact the pressure transducer. The only way for the probe to malfunction is for all the ports to be completely blocked. Most

substances likely to cover the probe are somewhat porous, which still allows the hydrostatic pressure of the flow stream over the probe to reach the transducer.

## 4.2 Circular Channels

**Consult your Isco Mounting Rings Installation and Operation Guide for detailed hardware information.**

The following sections describe sensor installation using the two options available for mounting sensors in pipes or round-bottomed flow streams. For pipes up to 15" (38.1 cm) in diameter, **stainless steel self-expanding mounting rings (Spring Rings)** are available. For pipes larger than 15" in diameter, Teledyne Isco offers the **Scissors Rings (Universal Mounting Rings)**.

### 4.2.1 Spring Rings

To install a spring ring, you compress the ring, slip it inside the pipe, and then allow it to spring out to contact the inside diameter of the pipe. The inherent outward spring force of the ring firmly secures it in place. A typical self-expanding mounting ring (with a probe mounted on it) is shown in Figure 4-1.

These mounting rings are available for use in pipes with inside diameters of 6" (15.2 cm), 8" (20.3 cm), 10" (25.4 cm), 12" (30.5 cm), and 15" (38.1 cm). The Teledyne Isco part numbers for the various size mounting rings available are listed in Appendix B. These part numbers include not only the ring, but also the miscellaneous hardware necessary to mount the sensor on the ring.

 <b>CAUTION</b>
--

Always wear leather gloves when handling the rings (either type). The metal is finished, but there is still a possibility of cutting your hands on the edges.

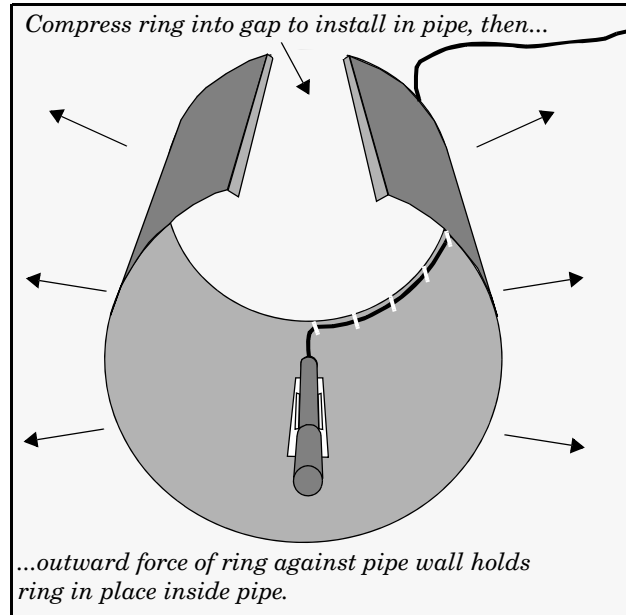

Figure 4-1 Sensor Installed on a Spring Ring

*Attaching the Sensor to the Ring*

Attach the probe to the ring either by using two 4-40 x  $\frac{3}{16}$ " countersink screws or by snapping the optional probe carrier to the ring. This second method of attaching the sensor allows for easy removal in case service is needed later.

**CAUTION**

Make sure the slots on the probe carrier are completely pressed onto the tabs on the ring. This is particularly important where there is any possibility of reverse flows, or where flows are of high velocity. If the probe is not fully pressed onto the mounting ring tabs, it might come loose in the stream, and could possibly be damaged or lost.

To complete the sensor-spring ring assembly procedure, attach the sensor cable to the downstream edge of the ring. Follow the cable routing shown in Figure 4-1. Other routing directions may affect measurement accuracy. The cable can actually create a stilling well downstream from the sensor, causing the level to read low. Use the self-locking plastic ties supplied with the ring. Install the ring in the pipe by compressing it. Press inward on both sides and slide the ring into the pipe.

Route the sensor cable out of the stream and secure it in position by placing the ties through the holes in the mounting ring and then locking them around the cable, as shown. To prevent debris from catching on the cable, it is important to attach the cable to the mounting ring so it offers as little resistance to the flow as possible.

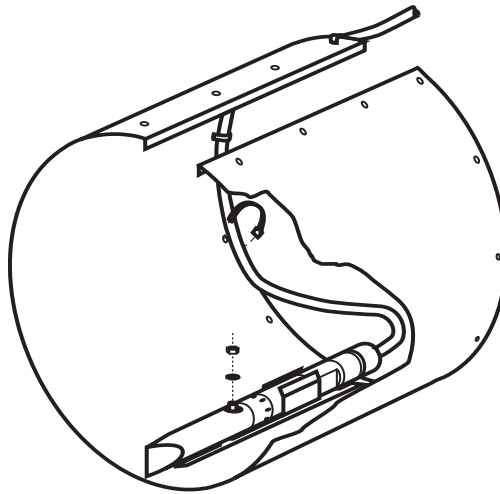

Figure 4-2 Spring Ring Preparation

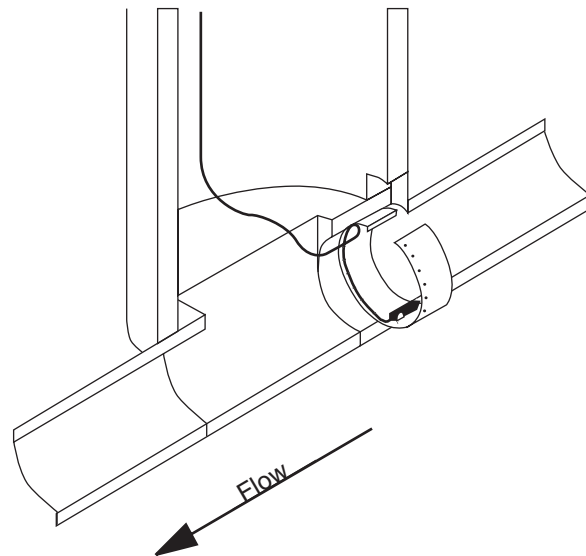

Figure 4-3 Mounting Ring in a Round Pipe

**⚠ CAUTION**

Make sure the sensor cable is securely fastened along the back (downstream) edge of the ring. Otherwise, the sensor may provide **inaccurate level readings** under conditions of high velocity.

Do not overtighten the plastic cable ties; they should be tightened just enough to secure the cable in place, without greatly indenting the cable. Overtightening the plastic ties may collapse the reference tube in the cable, blocking it.

The spring ring may need anchoring. Under conditions of high velocity (greater than 5 feet per second or 1.5 meters per second), the ring may not have sufficient outward spring force to maintain a tight fit inside the pipe. The ring may start to lift off the bottom of the pipe in a waving fashion, or may even be carried downstream.

This problem is more prevalent in the larger diameter pipes (10", 12", and 15", and in pipes with smooth inside surfaces, such as plastic pipes). If any of these conditions are present, or if movement of the mounting ring is detected or suspected, you must anchor the ring in place. You can do this by setting screws through the ring into the pipe, or by other appropriate means. If there is a problem with the smaller diameter rings, it may be sufficient to simply increase the outward spring force of the ring by bending it into a less round configuration.

#### 4.2.2 Scissors Rings

For pipes larger than 15" in diameter, Teledyne Isco offers the adjustable Scissors Ring (also known as the Universal Mounting Ring). This device consists of two or more metal strips that lock together with tabs to form a single assembly. There is a base section where the sensors are mounted, one or more extension sections (usually), and a scissors section at the top that expands the entire assembly and tightens it inside the pipe. The scissors mechanism includes a long screw that increases the width as it is tightened.

The assembled rings fit pipe diameters from 16" to 80". Secure the unit in place by tightening the scissors mechanism with a  $\frac{5}{8}$ " socket wrench or other suitable tool. Ring sections are .040" thick half-hard 301 stainless steel sheet. All other parts are also stainless steel, except for the plastic cable ties in the hardware kit.

Each extension, 1, 2, 3, and 4, adds 9.0", 21.5", 31.5", or 41.5", respectively, to the circumference of the ring. Used alone, the base section fits pipe that is approximately 16" to 18" in diameter. The 9.0" (the smallest) extension exists so that in larger pipe sizes, where large variations in circumference can occur, you can use one or two of these extensions to take up or remove slack, to bring the scissors mechanism into a position where it can be effectively tightened.

Mounting ring kits are available for different pipe sizes. A kit is also available for partial pipe applications (see your *Isco Mounting Rings Installation and Operation Guide*). For a listing of part numbers and ordering information, see Appendix B.

 <b>CAUTION</b>
--

Do not overtighten the plastic cable ties; they should be tightened just enough to secure the cable in place, without greatly indenting the cable. Overtightening the plastic ties may collapse the reference tube in the cable, blocking it.

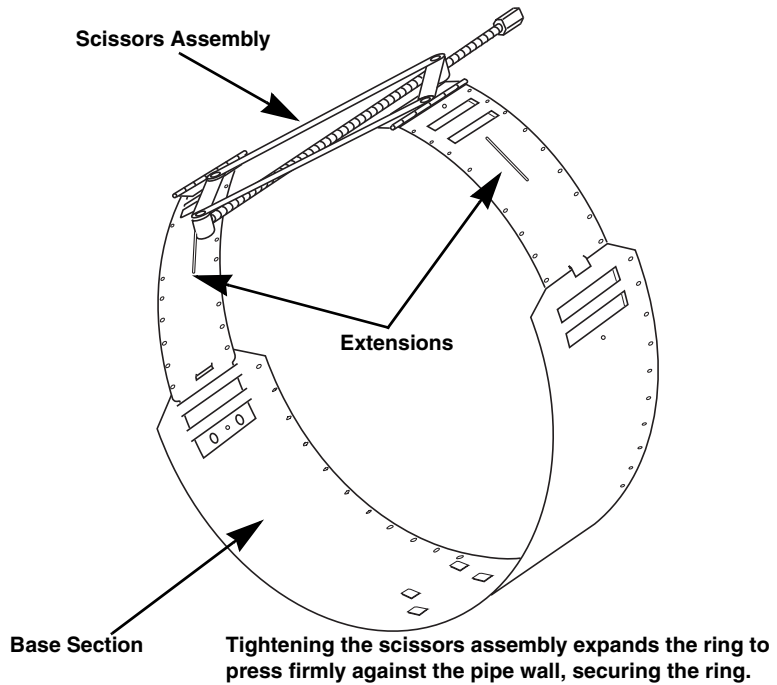

Figure 4-4 Universal Mounting Ring Adjustment

### 4.3 Other Mounting Techniques

Many installations require mounting methods other than mounting rings. Some alternative mounting methods are described below. Contact Teledyne Isco for assistance in determining your specific installation needs.

#### 4.3.1 Rectangular and Trapezoidal Channels

A flat, anchored mounting plate is a common mounting choice for installing sensors in rectangular or trapezoidal channels. You can also install the probe in rectangular channels by bending a mounting ring to fit the channel. Attach the ring to the channel wall with studs. Consult your *Isco Mounting Rings Installation and Operation Guide* for more information.

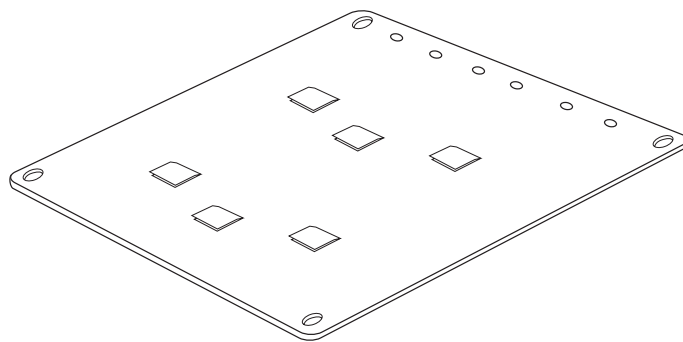

Figure 4-5 Isco Rectangular Mounting Plate



- 4.3.2 Stilling Wells or Streams with Very Low Velocity** In flow streams with a minimal flow velocity or in a stilling well, simply attach the probe to a weighted plate and submerge the plate in the stream or stilling well.
- 4.3.3 Securing Probe with a Weighted Plate** In situations with a minimal flow velocity (for example, in a stilling well), you can simply attach the probe to a weighted plate and submerge it in the flow.
- 4.3.4 Weirs and Flumes** The 720 is generally used with some type of primary measuring device, such as a weir or flume. The placement of the submerged probe in the primary device is determined by the type of primary device. You can use one of Isco's mounting rings to install the probe in many weirs and flumes. If the mounting ring are not suitable, you must build your own mounting hardware. Figure 3-1 shows the dimensions of the probe for your reference when building your own hardware. Figure 4-6 shows the probe installed in several primary devices.
- Certain flume manufacturers produce flumes with built-in cavities for Isco's submerged probe. Contact the flume manufacturer for details on the special flumes.

**☑ Note**

Always install the submerged probe pointing toward normal flow at the head-measuring point of the device. The location of the measuring point varies with each device. Refer to Table 4-1 or to the Isco Open Channel Flow Measurement Handbook.

<b>Table 4-1 Locating the Head-Measuring Point</b>	
<b>Device</b>	<b>Head-Measuring Point</b>
Weirs	Upstream from the weir plate by at least 3 times the maximum head.
Parshall Flumes	1/3 of the way into the converging section.
Palmer-Bowlus Flumes	Upstream from the flume entrance by half the pipe diameter.

**☑ Note**

When installing the probe with custom hardware, remember to attach the probe securely to the side or bottom of the flow stream and tie the cable down so that it does not collect debris.

For many primary measuring device installations, the submerged probe mounting rings or base sections discussed previously may be used to mount the probe at the appropriate location. In many installations, though, the mounting rings or bases may not be suitable.

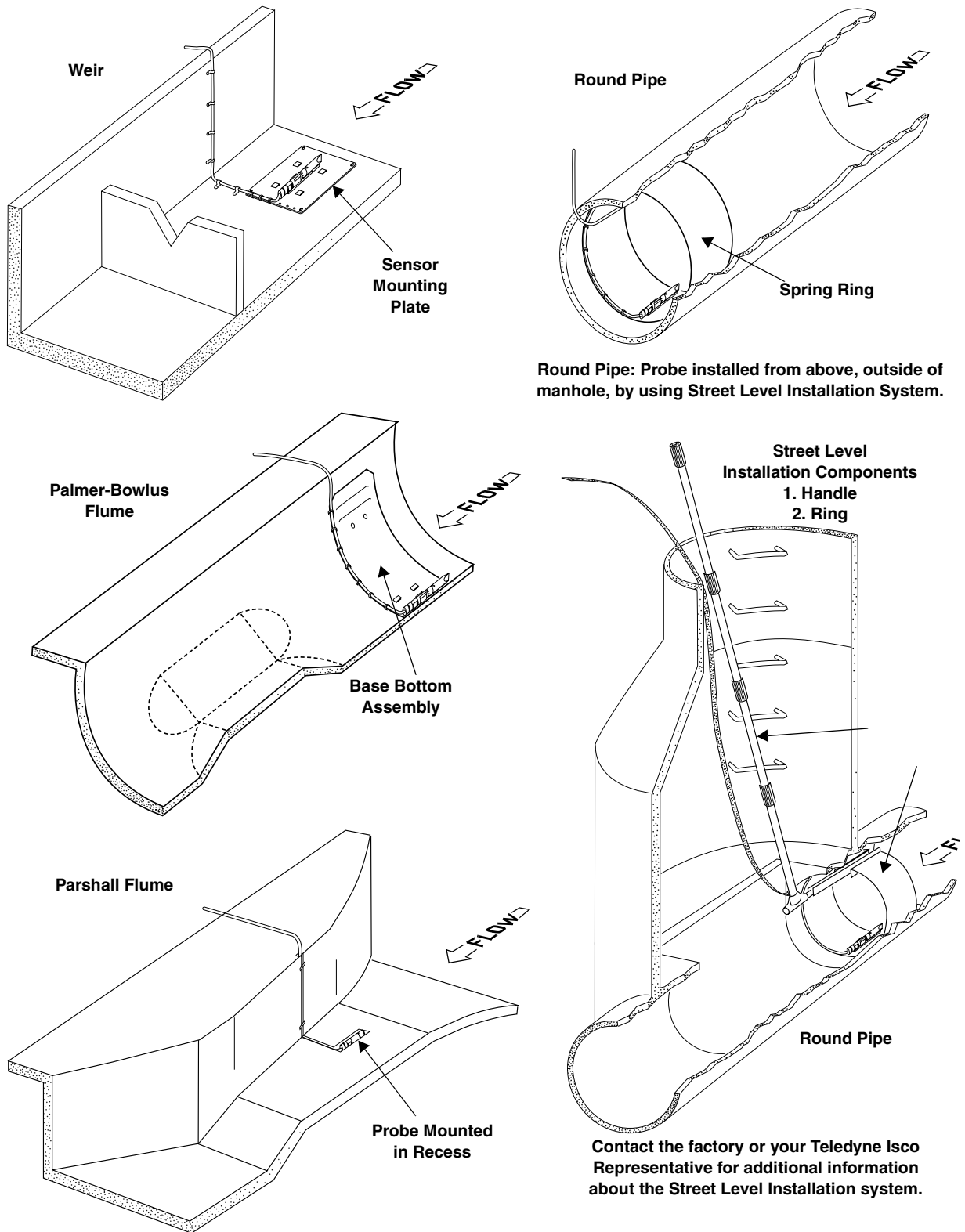

Round Pipe: Probe installed from above, outside of manhole, by using Street Level Installation System.

Contact the factory or your Teledyne Isco Representative for additional information about the Street Level Installation system.

Figure 4-6 Typical Primary Device Installations

Mounting hardware may have to be fabricated locally to allow the level sensor to be mounted at the correct location in the primary device. The only requirements for custom mounting hardware are:

- The probe must be securely attached to the side or bottom of the flow stream.
- The cable must be tied down and led out of the flow stream in an orderly manner.
- The hardware be made from corrosion-resistant materials.

It should be noted that the mounting rings may be used to install the probe in rectangular channels by simply putting right angle bends in them at the appropriate locations. It should be noted that certain flume manufacturers produce flumes with built-in cavities designed specifically for use with Isco submerged probe level sensors. Typically, these are Parshall or Palmer-Bowlus flumes. Contact the manufacturer for details on these flumes.

#### 4.4 Completing the Probe Installation

The submerged probe installation is finished by coiling any excess sensor cable and securing it using cable clamps or other means. The reference tube inside the cable can be restricted or blocked if the cable is kinked, sharply bent, or otherwise pinched. The probe cable should be handled and mounted with care. Also, if there is any appreciable distance between the point where the probe cable leaves the mounting apparatus and the location of the flow meter, be sure to attach the cable to the flow stream wall to prevent it from vibrating, moving around, tangling, or possibly collecting debris.

 <b>CAUTION</b>
--

Under no circumstances should you leave any extra length of sensor cable dangling freely in the flow stream where it could trap debris or become tangled.

Use gloves and eye protection when assembling and installing the rings in a pipe. Though deburred, the edges of the stainless steel can cut if improperly handled. *Please read the information on how best to install this device.*

Observe general safety procedures when entering any man-hole. See “General Safety Procedures” in the back of the manual for more information on general hazards and necessary precautions.



# 720 Submerged Probe Module

---

## *Section 5 Module and Probe Maintenance*

### 5.1 Cleaning the Submerged Probe

The 720 Module and Submerged Probe have no user-serviceable parts. They are completely sealed to protect the internal components. If you think the module or probe requires repair, contact Teledyne Isco's Customer Service Department.

The Submerged Probe will provide reliable readings over a long service life with a minimum of maintenance. Maintaining the probe requires regular cleaning and keeping the desiccant active.

The submerged probe may require occasional cleaning. Because the probe body offers a streamlined profile to the flow, solid materials rarely collect on its surface. However, remove debris from the flow stream near the probe periodically to maintain the hydrostatic conditions on which the level-to-flow conversion is based.

The probe functions even when covered with silt, sand, or other solid materials. However, organic materials may become jammed inside the probe. This material swells as it becomes saturated with water and exerts pressure on the diaphragm. This can damage the diaphragm, permanently disabling the probe. If all liquid ports in the probe become blocked, or if the diaphragm cavity is packed with material, clean the probe. This not only protects the probe from damage, but ensures that the probe responds to the hydrostatic pressure above the probe instead of the pressure created by the swollen material inside the probe.

To clean the probe:

1. Remove the probe and its mounting ring from the flow stream.
2. Scrape any accumulated solids off the exterior of the probe. Use a brush and flowing water. Gently flush the cavities of the probe with water.

If the ports are thoroughly blocked or if you need to clean the probe for storage:

1. Remove the probe nose section by unscrewing the two screws which hold the nose section in place and pull the nose section straight out of the probe body.
2. **Gently** flush the probe cavity with water to remove any solid materials.

**CAUTION**

Do not remove the warning disk at any time. The stainless steel diaphragm on the face of the probe's pressure transducer is extremely vulnerable to pressure. Damage to the diaphragm permanently disables the probe.



Warning Disk

3. Reinstall the nose section and tighten the two screws. Align the large mounting hole with the grounding point (Figure 5-1).

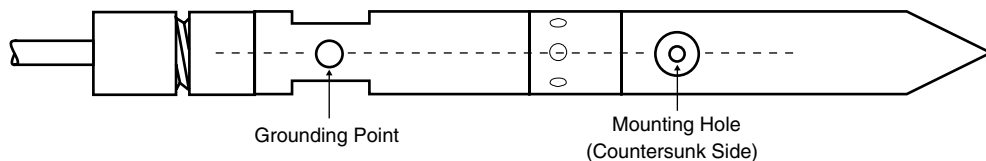
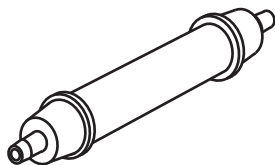

Figure 5-1 Grounding Point and Mounting Hole Alignment

## 5.2 Desiccant Reactivation



Desiccant Cartridge

A cartridge on the side of the module dries the air inside the module and probe reference line. It contains a silica gel desiccant with a color indicator that changes from blue to pink, or yellow to green when saturated. Pink or green desiccant cannot remove moisture and must be replaced or reactivated.

To reactivate the desiccant, pour the desiccant out of the cartridge into a heat-resistant container. Never heat the plastic cartridge; it will melt. Heat the silica gel in a vented convection oven at 212° to 350° F (100° to 175° C) for two to three hours, or until the blue or yellow color returns. Allow the desiccant to cool and then refill the cartridge.

**CAUTION**

Desiccant may produce irritating fumes when heated. Observe the following precautions:

- Use a vented oven in a well-ventilated room.
- Do not remain in the room while the regeneration is taking place.
- Use the recommended temperature. Avoid heating the desiccant at higher than recommended temperatures.

The desiccant's ability to remove moisture may lessen with each saturation/reactivation cycle, resulting in a need for more frequent service. After several cycles, the desiccant may no longer be effective as it saturates too quickly. At this point, replace the desiccant.

The sponge filters in the end caps keep small pieces of the desiccant material from falling out of the cartridge. When the filters become soiled, wash with dish soap and water, then allow to dry.

### **5.3 Flash Memory and Software Upgrades**

The module has Flash memory to store its software. With Flash technology, you can upgrade your module's software without sending it back to the factory or replacing a chip.

To update the module software, install the module in a 6700 series sampler. Then connect the sampler power source and turn the sampler on. Connect the sampler to a computer and follow the instructions received with your Flash Update program.





# 720 Submerged Probe Module

## *Appendix A Replacement Parts List*

The following table contains information about replacement parts and accessories. Replacement parts and accessories can be purchased by contacting Teledyne Isco's Customer Service Department.

<b>Table A-1 Replacement Parts and Accessories</b>	
<b>Part Description</b>	<b>Part Number</b>
720 Submerged Probe Module	60-9004-030
Submerged Probe 10' range with 25' cable	60-3224-002
720 Submerged Probe Instruction Manual	60-9003-368
Sensor Carrier	60-3204-005
Isco Open Channel Flow Measurement Handbook	60-3003-041
Spring Ring - 6" Dia.	68-3200-007
Spring Ring - 8" Dia.	68-3200-008
Spring Ring - 10" Dia.	68-3200-009
Spring Ring - 12" Dia.	68-3200-010
Spring Ring - 15" Dia.	68-3200-011
<i>(Each spring ring includes plastic ties to fasten the probe cable.)</i>	
Scissors Ring for 16" - 23" Pipe	68-3000-042
Scissors Ring for 16" - 36" Pipe	68-3000-043
Scissors Ring for 39" - 43" Pipe	68-3000-044
Scissors Ring for 45" - 49" Pipe	68-3000-045
Scissors Ring for 58 to 62" Pipe	68-3000-046
Scissors Ring for 72" Pipe	68-3000-047
Scissors Ring for 16" - 80" Pipe	68-3000-048
<i>(Each scissors ring includes a base section, scissors mechanism, extensions, plastic ties, and instructions)</i>	
Base Section <i>(Includes plastic ties and instructions)</i>	60-3004-169
Scissors Mechanism	60-3004-170
Street Level Installation System Multi-Section Pole.	60-3204-012
<i>(Includes instruction manual. To complete your system, you must also order a Street Level Mounting Ring.)</i>	
Street Level Mounting Ring for 6" diameter pipe	60-3204-014
Street Level Mounting Ring for 8" diameter pipe	60-3204-015

**Table A-1 Replacement Parts and Accessories (Continued)**

<b>Part Description</b>	<b>Part Number</b>
Street Level Mounting Ring for 10" diameter pipe	60-3204-016
Street Level Mounting Ring for 12" diameter pipe	60-3204-017
Street Level Mounting Ring for 15" diameter pipe	60-3204-018
Sensor Mounting Plate <i>(includes plastic ties and instructions)</i>	68-3000-051
Desiccant Cartridge Assy	60-9004-105
Quick Disconnect Box	60-3224-003
Standard Nose Section	60-2503-086
Slanted Nose Section	60-2503-097
Flume Probe Cap	60-2503-105

# 720 Submerged Probe Module

## Appendix B Technical Specifications

The following tables contain information covering the technical specifications of the 720 Module and Submerged Probes, including operating and storage temperatures, physical dimensions and weights, operating method and ranges, and memory capacity.

General Notes:

1. All weights may vary  $\pm 0.2$  lb ( $\pm 0.1$  kg).
2. All lengths may vary  $\pm 0.23$  inch ( $\pm 0.64$  cm).

<b>Table B-1 Technical Specifications for the 720 Submerged Probe Module</b>	
Operating Temperature	0° to 140° F (-18° to 60° C)
Storage Temperature	-40° to 140° F (-40° to 60° C)
Power	Provided by the sampler
Level Resolution	0.002 ft (0.0006 m)
Memory	Nonvolatile programmable Flash. Can be field updated through the sampler.
Readings	Programmable through sampler at 1, 2, 5, 10, 15, and 30 minute intervals. All readings are stored in the sampler.
Weight	0.9 lbs (0.4 kg)
Dimensions	4.9 x 5.7 x 2.0 inches (12.4 x 14.5 x 5.1 cm)
Material	Polystyrene
Enclosure	NEMA 4X and 6, IP67

<b>Table B-2 Technical Specifications for the Submerged Probe</b>	
Operating Temperature	32° to 160° F (0° to 71° C)
Storage Temperature	-40° to 160° F (-40° to 71° C)
Level Measurement Method	Submerged pressure transducer mounted in the flow stream.
Transducer Type	Differential linear integrated circuit pressure transducer.
Level Measurement Range	0.1 ft to 10 ft (0.03 m to 3.05 m)
Maximum Allowable Level	20 ft (6.1 m)
Level Measurement Accuracy	0.033 to 5.0 ft: $\pm 0.008$ ft/ft      (0.01 to 1.52 m: $\pm 0.008$ m/m) >5.0 ft: $\pm 0.012$ ft/ft      (>1.52 m: $\pm 0.012$ m/m)  @ 77° F (25° C). Includes non-linearity, repeatability, and hysteresis, but does not include temperature coefficient.
Compensated Temperature Range	32° to 100° F (0° to 38° C)

<b>Table B-2 Technical Specifications for the Submerged Probe (Continued)</b>	
Temperature Coefficient	0.1 to 4.0 ft: $\pm 0.005$ ft/°F (0.03 to 1.22 m: $\pm 0.0027$ m/°C) 4.0 to 10.0 ft: $\pm 0.007$ ft/°F (1.22 to 3.05 m: $\pm 0.0038$ m/°C) Maximum error over compensated temperature range, per degree of temperature change.
Sensor Dimensions	Diameter: 0.875 inches (2.2 cm) Length: 5.5 inches (14.0 cm) without nose 9.5 inches (24.1 cm) with standard nose Frontal Area: 0.601 in <sup>2</sup> (3.88 cm <sup>2</sup> )
Amplifier Box	Watertight enclosure
Cable Length:	25 feet (7.6 m) from sensor to amplifier box
Weight	3 lbs (1.4 kg) Entire probe and cable
Materials	Probe Body: CPVC Transducer Diaphragm: Type 316 stainless steel Cable: PVC

# 720 Submerged Probe Module

---

## *Appendix C Material Safety Data Sheets*

### **C.1 Overview**

This appendix provides Material Safety Data Sheets for the desiccant used in the 720 Module.

Teledyne Isco cannot guarantee the accuracy of the data. Specific questions regarding the use and handling of the products should be directed to the manufacturer listed on the MSDS.

# Material Safety Data Sheet

Indicating Silica Gel

Identity (Trade Name as Used on Label)

Manufacturer : MULTISORB TECHNOLOGIES, INC. (formerly Multiform Desiccants, Inc.)	MSDS Number* : M75
Address: 325 Harlem Road Buffalo, NY 14224	CAS Number* :
Phone Number (For Information): 716/824-8900	Date Prepared: July 6, 2000
Emergency Phone Number: 716/824-8900	Prepared By* : G.E. McKedy

## Section 1 - Material Identification and Information

Components - Chemical Name & Common Names (Hazardous Components 1% or greater; Carcinogens 0.1% or greater)	%*	OSHA PEL	ACGIH TLV	OTHER LIMITS RECOMMENDED
Silica Gel SiO <sub>2</sub>	98.0	6mg/m <sup>3</sup> (total dust)	10mg/m <sup>3</sup> (total dust)	
Cobalt Chloride	>2.0	0.05mg/m <sup>3</sup> (TWA cobalt metal dust & fume)	.05mg/m <sup>3</sup> (Cobalt, TWA)	
Non-Hazardous Ingredients				
<b>TOTAL</b>	100			

## Section 2 - Physical/Chemical Characteristics

Boiling Point	N/A	Specific Gravity (H <sub>2</sub> O = 1)	2.1
Vapor Pressure (mm Hg and Temperature)	N/A	Melting Point	N/A
Vapor Density (Air =1)	N/A	Evaporation Rate (_____ =1)	N/A
Solubility in Water	Insoluble, but will adsorb moisture.	Water Reactive	Not reactive, but will adsorb moisture.
Appearance and Odor	Purple crystals, no odor.		

## Section 3 - Fire and Explosion Hazard Data

Flash Point and Methods Used	N/A	Auto-Ignition Temperature	N/A	Flammability Limits in Air % by Volume	N/A	LEL	UEL
Extinguisher Media	Dry chemical, carbon dioxide and foam can be used.						
Special Fire Fighting Procedures	Water will generate heat due to the silica gel which will adsorb water and liberate heat.						
Unusual Fire and Explosion Hazards	When exposed to water, the silica gel can get hot enough to reach the boiling point of water. Flooding with water will reduce the temperature to safe limits.						

## Section 4 - Reactivity Hazard Data

<b>STABILITY</b> <input type="checkbox"/> Stable <input type="checkbox"/> Unstable	Conditions To Avoid	Moisture and high humidity environments.
Incompatibility (Materials to Avoid)	Water.	
Hazardous Decomposition Products	Carbon dioxide, carbon monoxide, water	
<b>HAZARDOUS POLYMERIZATION</b> <input type="checkbox"/> May Occur	Conditions To Avoid	None.

\*Optional

Indicating Silica Gel

**Section 5 - Health Hazard Data**

<b>PRIMARY ROUTES OF ENTRY</b>	<input type="checkbox"/> Inhalation	<input type="checkbox"/> Ingestion	<b>CARCINOGEN LISTED IN</b>	<input type="checkbox"/> NTP	<input type="checkbox"/> OSHA
	<input type="checkbox"/> Skin Absorption	<input type="checkbox"/> Not Hazardous		<input type="checkbox"/> IARC Monograph	<input type="checkbox"/> Not Listed
<b>HEALTH HAZARDS</b>	Acute May cause eye, skin and mucous membrane irritation.				
	Chronic Prolonged inhalation may cause lung damage.				
Signs and Symptoms of Exposure	Drying and irritation.				
Medical Conditions Generally Aggravated by Exposure	Asthma.				
<b>EMERGENCY FIRST AID PROCEDURES</b> - Seek medical assistance for further treatment, observation and support if necessary.					
Eye Contact	Flush with water for at least 15 minutes.				
Skin Contact	Wash affected area with soap and water.				
Inhalation	Remove affected person to fresh air.				
Ingestion	Drink at least 2 glasses of water.				

**Section 6 - Control and Protective Measures**

Respiratory Protection (Specify Type)	Use NIOSH approved dust mask or respirator.				
Protective Gloves	Light cotton gloves.		Eye Protection	Safety glasses.	
<b>VENTILATION TO BE USED</b>	<input type="checkbox"/> Local Exhaust	<input type="checkbox"/> Mechanical (General)	<input type="checkbox"/> Special		
	<input type="checkbox"/> Other (Specify)				
Other Protective Clothing and Equipment	None.				
Hygienic Work Practices	Avoid raising dust. Avoid contact with skin, eyes and clothing.				

**Section 7 - Precautions for Safe Handling and Use/Leak Procedures**

Steps to be Taken if Material Is Spilled Or Released	Sweep or vacuum up and place the spilled material in a waste disposal container. Avoid raising dust.				
Waste Disposal Methods	Dispose in an approved landfill according to federal, state and local regulations.				
Precautions to be Taken In Handling and Storage	Cover promptly to avoid blowing dust. Wash after handling.				
Other Precautions and/or Special Hazards	Keep in sealed containers away from moisture. The silica gel will readily adsorb moisture.				

\*Optional

Indicating Silica Gel



## MATERIAL SAFETY DATA SHEET

**Effective Date** March 8, 2005  
**MSDS Number** M163

### Section 1 – Product and Company Information

**Product Name:** Silica gel, indicating, yellow

**Product Use:** Desiccant, absorbent

**Grades:** Silica gel, indicating

**Synonyms:** Amorphous silica gel, SiO<sub>2</sub>, silicon dioxide (amorphous)

**Company:** Multisorb Technologies, Inc.

**Street Address:** 325 Harlem Road

**City, State, Zip, Country:** Buffalo, NY 14224-1893 USA

**Telephone Number:** (716) 824 8900 [USA] Monday - Friday (8:00 - 5:00 EDT)

**Fax Number:** (716) 824 4091 [USA]

**Website / E-Mail :** multisorb.com

### Section 2 – Composition / Information on Ingredients

Component Name	CAS Number	% by Weight
Synthetic amorphous silica gel (SiO <sub>2</sub> )	112926-00-8	100
Phenolphthalein	77-09-08	100 ppm

While this material is not classified, this MSDS contains valuable information critical to the safe handling and proper use of this product. This MSDS should be retained and available for employees and other users of this product.

### Section 3 – Hazard Identification

**Emergency Overview:** A yellow bead or granular material that poses little or no immediate hazard. This material is not combustible.

**Potential Health Effects:**

**Eyes:** Dust and or product may cause eye discomfort and irritation seen as tearing and reddening.

**Skin:** The product dust may cause drying of the skin. Silica gel may get hot enough to burn skin when it adsorbs moisture rapidly. Use an excess of water to cool the silica gel.

**Ingestion:** Material is not toxic and will pass through the body normally.

**Inhalation:** Slight irritation is possible but none is expected.

**Medical Effects Generally Aggravated by Exposure:** Respiratory ailments.

**Chronic Effects/Carcinogenicity:** May cause eye, skin and mucous membrane irritation and drying.



#### Section 4 – First Aid Measures

- Eyes:** Rinse the eyes well with water while lifting the eye lids. If irritation persists, consult a physician.
- Skin:** Wash affected area with soap and water.
- Ingestion:** Ingestion is unlikely, this material will pass through the body normally.
- Inhalation:** Remove the affected person to fresh air and get medical attention if necessary.
- Notes to Physician:** Not applicable

#### Section 5 – Fire Fighting Measures

- Flammable Properties:** Not flammable
- Flash Point:** Not applicable                      **Method:** Not applicable
- Flammable Limits:** Not flammable
- Lower Flammability Limit:** Not applicable
- Upper Flammability Limit:** Not applicable
- Autoignition Temperature:** Not applicable
- Hazardous Combustion Products:** Not applicable
- Extinguishing Media:** Use extinguishing media that is appropriate for the surrounding fire. Silica gel is not combustible.
- Fire Fighting Instructions:** Not combustible
- Unusual Fire and Explosion Hazards:** None

#### Section 6 – Accidental Release Measures

- Spill:** Sweep or vacuum up and place the spilled material in a waste disposal container. Avoid raising dust. Wash with soap and water after handling.

#### Section 7 – Handling and Storage

- Handling:** Avoid raising dust and minimize the contact between worker and the material. Practice good hygienic work practices.
- Storage:** Store in a cool, dry location. Keep in sealed containers away from moisture. The silica gel will readily adsorb moisture.

**Section 8 – Exposure Controls/Personal Protection**

- Engineering Controls:** Use exhaust ventilation to keep the airborne concentrations below the exposure limits.
- Respiratory Protection:** Use NIOSH approved respirator when the air quality levels exceed the TLV's.
- Skin Protection:** Light gloves will protect against abrasion and drying of the skin.
- Eye Protection:** Safety glasses.

Component Name	Exposure Limits		
	OSHA PEL	ACGIH TLV	Other Recommended Limits
Silica gel	TWA 20 mppcf (80 mg / m <sup>3</sup> % SiO <sub>2</sub> )	TWA 10 mg / m <sup>3</sup>	NIOSH REL TWA 6 mg / m <sup>3</sup> IDLH 3000 mg / m <sup>3</sup>
Phenolphthalein	Not Applicable	Not Applicable	Not Applicable

**Section 9 – Physical and Chemical Properties**

- Appearance:** Yellow beads or granules      **Vapor Density:** Not applicable
- Odor:** None      **Boiling Point:** 4046° F (2230° C)
- Physical State:** Solid bead      **Melting Point:** 3110° F (1710° C)
- PH:** Not applicable      **Solubility:** Insoluble in water
- Vapor Pressure:** Not applicable      **Specific Gravity:** 2.1

**Section 10 – Stability and Reactivity**

- Stability:** Stable
- Conditions to avoid:** Moisture and high humidity environments.
- Incompatibility:** Water, fluorine, oxygen difluoride, chlorine trifluoride
- Hazardous Decomposition Products:** None
- Hazardous Polymerization:** Will not occur

### Section 11 – Toxicological Information

This product and its components are not listed on the NTP or OSHA Carcinogen lists.

**Animal Toxicology** Tests for DOT Hazard classification  
( Tests Conducted on finely ground silica gel)  
1 - hour LC<sub>50</sub> (rat) > 2 mg / l  
48 - hour oral LD<sub>50</sub> (rat) est. > 31,600 mg / kg  
48 - hour dermal LD<sub>50</sub> (rabbit) est. > 2,000 mg / kg  
Considered an ocular irritant

**Human Toxicology** Silica gel is a synthetic amorphous silica not to be confused with crystalline silica. Epidemiological studies indicate low potential for adverse health effects. In the activated form, silica gel acts as a desiccant and can cause a drying irritation of the mucous membranes and skin in cases of severe exposure. Multisorb Technologies Inc. knows of no medical conditions that are abnormally aggravated by exposure to silica gel. The primary route of entry is inhalation of dust.

### Section 12 – Ecological Information

Not known to have any adverse effect on the aquatic environment. Silica gel is insoluble and non-toxic.

### Section 13 – Disposal Information

**Disposal Information** If this product as supplied becomes a waste, it does not meet the criteria of a hazardous waste as defined under the Resource Conservation and Recovery Act (RCRA) 40 CFR 261. Materials of a hazardous nature that contact the product during normal use may be retained on the product. The user of the product must identify the hazards associated with the retained material in order to assess the waste disposal options. Dispose according to federal, state and local regulations.

### Section 14 – Transportation Information

**U.S. Department of Transportation Shipping Name:** Not classified as a hazardous material. Not regulated.

### Section 15 – Regulatory Information (Not meant to be all inclusive - selected regulations represented)

**TSCA Listed:** Yes

**DSL/NDSL (Canadian) Listed:** Yes

**OSHA:** TWA 20 mppcf (80 mg / m<sup>3</sup> % SiO<sub>2</sub>) for Silica gel

**NIOSH:** REL TWA 6 mg / m<sup>3</sup> IDLH 3,000 mg / m<sup>3</sup> for silica gel  
Animal tests conducted in 1976 - 1978. 18 month exposure at 15 mg / m<sup>3</sup> showed silica deposition in respiratory macrophages and lymph nodes, minimum lung impairment, no silicosis.

**ACGIH:** TLV - 10 mg / m<sup>3</sup> for Silica gel

**DOT:** Not classified as a hazardous material.

**Section 16 – Other Information**

**HMIS – Hazardous Materials Identification System**

HMIS Rating	
Health	0
Flammability	0
Reactivity	0

**0 - minimal hazard, 1 - slight hazard, 2 - moderate hazard, 3 - serious hazard, 4 - severe hazard**

This MSDS was prepared by: George E. Mckedy  
Senior Applications Development Specialist  
Multisorb Technologies, Inc.

This data and recommendations presented in this data sheet concerning the use of our product and the materials contained therein are believed to be correct but does not purport to be all inclusive and shall be used only as a guide. However, the customer should determine the suitability of such materials for his purpose before adopting them on a commercial scale. Since the use of our products is beyond our control, no guarantee, expressed or implied, is made and no responsibility assumed for the use of this material or the results to be obtained therefrom. Information on this form is furnished for the purpose of compliance with Government Health and Safety Regulations and shall not be used for any other purposes. Moreover, the recommendations contained in this data sheet are not to be construed as a license to operate under, or a recommendation to infringe, any existing patents, nor should they be confused with state, municipal or insurance requirements, or with national safety codes.

## ***Teledyne Isco One Year Limited Factory Service Warranty \****

Teledyne Isco warrants covered products against failure due to faulty parts or workmanship for a period of one year (365 days) from their shipping date, or from the date of installation by an authorized Teledyne Isco Service Engineer, as may be appropriate.

During the warranty period, repairs, replacements, and labor shall be provided at no charge. Teledyne Isco's liability is strictly limited to repair and/or replacement, at Teledyne Isco's sole discretion.

Failure of expendable items (e.g., charts, ribbon, tubing, lamps, glassware, seals, filters, fittings, and wetted parts of valves), or from normal wear, accident, misuse, corrosion, or lack of proper maintenance, is not covered. Teledyne Isco assumes no liability for any consequential damages.

This warranty does not cover loss, damage, or defects resulting from transportation between the customer's facility and the repair facility.

Teledyne Isco specifically disclaims any warranty of merchantability or fitness for a particular purpose.

This warranty applies only to products sold under the Teledyne Isco trademark and is made in lieu of any other warranty, written or expressed.

No items may be returned for warranty service without a return authorization number issued from Teledyne Isco.

The warrantor is Teledyne Isco, Inc.  
4700 Superior, Lincoln, NE 68504, U.S.A.

**\* This warranty applies to the USA and countries where Teledyne Isco Inc. does not have an authorized dealer. Customers in countries outside the USA, where Teledyne Isco has an authorized dealer, should contact their Teledyne Isco dealer for warranty service.**

*In the event of instrument problems, always contact the Teledyne Isco Service Department, as problems can often be diagnosed and corrected without requiring an on-site visit. In the U.S.A., contact Teledyne Isco Service at the numbers listed below. International customers should contact their local Teledyne Isco agent or Teledyne Isco International Customer Service.*

### **Return Authorization**

A return authorization number must be issued prior to shipping. Following authorization, Teledyne Isco will pay for surface transportation (excluding packing/crating) both ways for 30 days from the beginning of the warranty period. After 30 days, expense for warranty shipments will be the responsibility of the customer.

**Shipping Address:** Teledyne Isco, Inc. - Attention Repair Service  
4700 Superior Street  
Lincoln NE 68504 USA

**Mailing address:** Teledyne Isco, Inc.  
PO Box 82531  
Lincoln NE 68501 USA

**Phone:** Repair service: (800)775-2965 (lab instruments)  
(800)228-4373 (samplers & flow meters)  
Sales & General Information (800)228-4373 (USA & Canada)

**Fax:** (402) 465-3001

**Email:** [iscoservice@teledyne.com](mailto:iscoservice@teledyne.com) **Web site:** [www.isco.com](http://www.isco.com)



