

# 6712FR Refrigerated Sampler

## Installation and Operation Guide



Part #69-9003-590 of Assembly #60-9004-335  
Copyright © 2001. All rights reserved, Teledyne Isco  
Revision KS, July 2018



## Foreword

This instruction manual is designed to help you gain a thorough understanding of the operation of the equipment. Teledyne ISCO recommends that you read this manual completely before placing the equipment in service.

Although Teledyne ISCO designs reliability into all equipment, there is always the possibility of a malfunction. This manual may help in diagnosing and repairing the malfunction.

If a problem persists, call or e-mail Teledyne ISCO technical support for assistance. Simple difficulties can often be diagnosed over the phone. For faster service, please have your serial number ready.

If it is necessary to return the equipment to the factory for service, please follow the shipping instructions provided by technical support, including the use of the **Return Material Authorization (RMA)** specified. **Be sure to include a note describing the malfunction.** This will aid in the prompt repair and return of the equipment.

Teledyne ISCO welcomes suggestions that would improve the information presented in this manual or enhance the operation of the equipment itself.

**Teledyne ISCO is continually improving its products and reserves the right to change product specifications, replacement parts, schematics, and instructions without notice.**

## Contact Information

### *Customer Service*

Phone: (800) 228-4373 (USA, Canada, Mexico)  
(402) 464-0231 (Outside North America)  
Fax: (402) 465-3022  
Email: ISCO\_CSR@teledyne.com

### *Technical Support*

Phone: Toll Free (800) 775-2965 (Syringe Pumps and Liquid Chromatography)  
Email: IscoService@teledyne.com  
Return equipment to: 4700 Superior Street, Lincoln, NE 68504-1398

### *Other Correspondence*

Mail to: P.O. Box 82531, Lincoln, NE 68501-2531  
Email: IscoInfo@teledyne.com

**EAR-Controlled Technology Subject to Restrictions Contained on the Cover Page.**



*Electrical Requirements*

The 6712FR Refrigerated Sampler is a “definite purpose” device, intended for use **only** with compatible Isco equipment. Do **not** use this product with any other manufacturers’ equipment, or for any other purpose. Use for any purpose not described in this manual could cause personal injury or property damage.

The refrigerator is available in both 115 V $\sim$  and 230 V $\sim$  configurations. The required operating voltage for the refrigerator is listed on the Identification and Serial Number label, placed on the inside of the sample compartment door.

Refrigerators configured for 115 V $\sim$  operation are equipped with a North American NEMA 5-15P plug and is intended for use **only** with 115 V $\sim$ , 60 Hz. The power source should be rated for 20 ampere service.

Refrigerators in either configuration provide 12.5 V $\text{---}$  at 5 amperes for the sampler controller. This output is from the two-pin military-type connector on the cord on top of the refrigerator. This output is intended for 6700 Series Sampler controllers **only**.



The refrigerator must be installed near a suitable power outlet. Never use an extension cord.



The power outlet must be visible and easily accessible. Unplugging the refrigerator is the only means of disconnecting power.



To minimize the risk of electrical shock, the refrigerator must be connected to an outlet with an electrical ground contact.



The power source must be a dedicated circuit. The line must not power any other devices.



Never operate the refrigerator with the lower front or rear panels removed.



Never operate the refrigerator in an explosive atmosphere.



Do not locate the refrigerator where the lower compartment could become submerged.



Do not lift or carry the refrigerator. Use an appliance carrying device.



Fuses must be replaced with the required size, current, voltage, and blow-time specifications. Refer to the *Replacement Parts List* for the correct part number.

*Hazard Severity Levels*

This manual applies *Hazard Severity Levels* to the safety alerts, These three levels are described in the sample alerts below.

**CAUTION**

Cautions identify a potential hazard, which if not avoided, may result in minor or moderate injury. This category can also warn you of unsafe practices, or conditions that may cause property damage.

**WARNING**

Warnings identify a potentially hazardous condition, which if not avoided, could result in death or serious injury.

**DANGER**

**DANGER – limited to the most extreme situations to identify an imminent hazard, which if not avoided, will result in death or serious injury.**

*General Warnings*

Before installing, operating, or maintaining this equipment, it is imperative that all hazards and preventive measures are fully understood. While specific hazards may vary according to location and application, take heed in the following general warnings:

**WARNING**

**This instrument has not been certified for use in “hazardous locations” as defined by the National Electrical Code.**

**WARNING**









**Avoid hazardous practices! If you use this instrument in any way not specified in this manual, the protection provided by the instrument may be impaired; this will increase your risk of injury.**

**AVERTISSEMENT**

**Éviter les usages périlleux! Si vous utilisez cet instrument d’une manière autre que celles qui sont spécifiées dans ce manuel, la protection fournie de l’instrument peut être affaiblie; cela augmentera votre risque de blessure.**

*Hazard Symbols*

The equipment and this manual use symbols used to warn of hazards. The symbols are explained below.

<b>Hazard Symbols</b>	
<b>Warnings and Cautions</b>	
	The exclamation point within the triangle is a warning sign alerting you of important instructions in the instrument's technical reference manual.
	The lightning flash and arrowhead within the triangle is a warning sign alerting you of "dangerous voltage" inside the product.
	Pinch point. These symbols warn you that your fingers or hands will be seriously injured if you place them between the moving parts of the mechanism near these symbols.
<b>Symboles de sécurité</b>	
	Ce symbole signale l'existence d'instructions importantes relatives au produit dans ce manuel.
	Ce symbole signale la présence d'un danger d'électocution.
	Risque de pincement. Ces symboles vous avertit que les mains ou les doigts seront blessés sérieusement si vous les mettez entre les éléments en mouvement du mécanisme près de ces symboles
<b>Warnungen und Vorsichtshinweise</b>	
	Das Ausrufezeichen in Dreieck ist ein Warnzeichen, das Sie darauf aufmerksam macht, daß wichtige Anleitungen zu diesem Handbuch gehören.
	Der gepfeilte Blitz im Dreieck ist ein Warnzeichen, das Sei vor "gefährlichen Spannungen" im Inneren des Produkts warnt.
	Vorsicht Quetschgefahr! Dieses Symbol warnt vor einer unmittelbar drohenden Verletzungsgefahr für Finger und Hände, wenn diese zwischen die beweglichen Teile des gekennzeichneten Gerätes geraten.





# 6712FR Refrigerated Sampler

---

## *Table of Contents*

### **Section 1 Introduction**

---

1.1 About This Manual . . . . .	1-1
1.2 About 700 Series Modules. . . . .	1-2
1.3 SDI-12 Sondes . . . . .	1-2
1.4 Telephone Communication . . . . .	1-2
1.4.1 4200T Landline Modem . . . . .	1-2
1.4.2 GSM Cellular Modem . . . . .	1-2
1.4.3 CDMA Cellular Modem for CSD . . . . .	1-3
1.4.4 6712Ci Modem . . . . .	1-3
1.4.5 Software Compatibility . . . . .	1-3
1.5 Memory to Store Monitoring Data . . . . .	1-5
1.6 Pump Requirements . . . . .	1-5
1.7 Features, Construction, and Specifications . . . . .	1-5

### **Section 2 Installation/Preparation**

---

2.1 Preparing the Sampler . . . . .	2-1
2.1.1 Installing the Distributor Shaft Extension . . . . .	2-1
2.1.2 Mounting the Controller . . . . .	2-1
2.1.3 Installing the Distributor Arm and Discharge Tube . . . . .	2-2
2.2 Installing Bottle Kits. . . . .	2-4
2.2.1 Installing Racks . . . . .	2-4
2.2.2 Removing Racks . . . . .	2-6
2.2.3 Installing Composite Bottles . . . . .	2-6
2.3 Suction Line . . . . .	2-7
2.3.1 Guidelines for Measuring and Cutting the Suction Line . . . . .	2-7
2.3.2 Attaching Suction Line to Pump Tube . . . . .	2-7
2.4 Strainers . . . . .	2-8
2.4.1 Alternative to Strainers . . . . .	2-8
2.5 How Does the Sampler Work? . . . . .	2-9
2.5.1 Measuring Sample Volume . . . . .	2-10
2.6 Installing the Sampler . . . . .	2-10
2.6.1 Tips for Routing Suction Line . . . . .	2-10
2.6.2 Intake Placement . . . . .	2-11
2.6.3 Positioning a Sampler . . . . .	2-11
2.7 Connecting External Instruments . . . . .	2-11
2.7.1 Flow Meter . . . . .	2-11
2.7.2 Rain Gauge Connector . . . . .	2-12
2.8 Locking the Sampler . . . . .	2-13
2.9 Servicing the Sampler . . . . .	2-13

### **Section 3 Programming Introduction**

---

3.1 Initial Operation . . . . .	3-1
3.1.1 Selecting a Language . . . . .	3-3
3.2 Using Menus and Entering Numbers . . . . .	3-3
3.2.1 Selecting Menu Options . . . . .	3-3
3.2.2 Entering Numbers . . . . .	3-3
3.3 Quick View Screens . . . . .	3-4
3.3.1 Paging Through Quick View Screens . . . . .	3-4

3.3.2	Changing Settings in a Quick View Screen	3-4
3.4	Clock and Calendar	3-5
3.4.1	Setting the Clock and Calendar	3-6
3.4.2	Menu Screens: Clock Start Times	3-6
3.5	Menu Screens: Site Descriptions and Program Names	3-7
3.6	Messages	3-8
3.6.1	Information Messages	3-9
3.6.2	Help Notes	3-9
3.6.3	Warning Messages	3-10
3.6.4	Operation Messages	3-10
3.7	Menu Trees	3-10

## Section 4 Standard Programming

---

4.1	Switching Between Standard and Extended Modes	4-1
4.2	Language Selection, Units of Length	4-1
4.3	Programming Examples	4-2
4.4	Pacing	4-5
4.4.1	Trigger Pacing	4-5
4.5	Distribution	4-6
4.5.1	Sequential	4-6
4.5.2	Bottles Per Sample	4-6
4.5.3	Samples Per Bottle	4-6
4.5.4	Composite	4-6
4.5.5	Continuous Sampling	4-6
4.6	Start Times	4-8
4.6.1	How Do Start Times Work?	4-8
4.6.2	Sampler Enable/Disable	4-9
4.7	Running Programs	4-10
4.7.1	Run Time Screens	4-10
4.7.2	Module Readings	4-11
4.8	Interrupting a Running Program	4-12
4.8.1	Stop Program	4-12
4.8.2	Resume Program	4-12
4.8.3	View Data	4-13
4.8.4	Grab Sample	4-13
4.8.5	Pump Tube Alarm	4-13
4.8.6	Calibrate Volume	4-13
4.8.7	Cal/Adj Parameters	4-13
4.8.8	Adjust Pacing	4-13
4.8.9	Adjust Volume	4-14
4.8.10	Power Used	4-14
4.9	Other Functions	4-14
4.10	Manual Functions	4-14
4.11	Grab Samples	4-14
4.12	Calibrate Volume	4-15
4.12.1	Calibration Tips	4-16
4.13	Operating the Pump	4-17
4.14	Moving the Distributor Arm	4-17
4.15	Reports	4-18
4.15.1	Collecting Reports	4-18
4.15.2	Viewing the Data	4-18
4.15.3	Configuring Reports	4-19
4.15.4	Sampling Results Report	4-20
4.15.5	Combined Results Report	4-20
4.15.6	Summary Report	4-20
4.16	System IDs	4-28
4.17	Programming for 700 Series Modules	4-28

---

## Section 5 Extended Programming

---

5.1	Extended and Standard Mode	5-1
5.2	One-Part and Two-Part Programs	5-1
5.3	Storage for Extended Programs	5-2
5.3.1	Selecting a Stored Program	5-2
5.4	Programming for 700 Series Modules	5-4
5.5	Programming Examples	5-4
5.5.1	Storm Water Runoff Sampling	5-4
5.6	Suction Head	5-12
5.7	Rinses and Retries	5-12
5.8	Pacing	5-12
5.8.1	Event Pacing	5-12
5.8.2	Event Paced Sampling	5-13
5.8.3	Nonuniform Time Pacing	5-15
5.8.4	Nonuniform Clock Time Pacing	5-15
5.8.5	Nonuniform Interval Pacing	5-15
5.8.6	Random Interval Pacing	5-15
5.9	Distribution	5-16
5.9.1	Sequential	5-16
5.9.2	Bottles Per Sample	5-16
5.9.3	Samples Per Bottle	5-16
5.9.4	Composite	5-16
5.9.5	Multiple Bottle Compositing	5-16
5.9.6	Time Switching	5-16
5.9.7	Continuous Sampling	5-17
5.10	Flow Proportional Sample Volumes	5-19
5.10.1	Calculating Variable Sample Volume Settings	5-20
5.10.2	Calculations when Using an External Flow Meter	5-21
5.10.3	Calculations when Using a 700 Series Flow Module	5-22
5.11	Sampler Enable	5-22
5.11.1	Sampler Enable	5-24
5.12	Sampler Enable Responses	5-25
5.12.1	Once Enabled Stay Enabled	5-25
5.12.2	Repeatable Enable	5-25
5.12.3	Sample at Enable or Disable	5-25
5.12.4	Delay To Start Of Sampling	5-26
5.12.5	“Dry Period” Option	5-26
5.12.6	Resetting the Sample Interval at Enable	5-26
5.13	Pauses/Resumes	5-27
5.14	Running Programs	5-27
5.14.1	Run Time Screens	5-27
5.14.2	Interrupting a Running Program	5-27
5.15	Sampling Reports	5-28
5.16	Other Functions	5-28
5.17	Software Options	5-28
5.17.1	Liquid Detector Enable/Disable	5-28
5.17.2	Programming Style	5-29
5.17.3	Measurement Interval	5-29
5.17.4	Dual Sampler Mode	5-29
5.17.5	Pre-sample and Post-sample Purge Counts	5-31
5.17.6	Serial Output	5-32
5.17.7	Program Lock	5-34
5.18	Hardware Setup	5-36
5.18.1	SDI-12 Sonde Setup	5-36
5.18.2	Rain Gauge Setup	5-36
5.18.3	I/O Pin Programming	5-37
5.18.4	Dialout Alarms	5-39
5.18.5	Pager Numbers	5-40

5.18.6 Digital Modem Text Messaging	5-40
5.18.7 Refrigerator Temperature	5-41
5.18.8 Analog Output	5-41
5.19 Memory	5-42
5.20 Pressurized Lines	5-44
5.21 Command Driven Operation	5-44
5.22 Command Driven Sampler Responses	5-45

## Section 6 SDI-12 Sondes

---

6.1 Teledyne Isco AQ700 Sonde	6-1
6.2 SDI-12 Data Parameters	6-2
6.3 Scanning For Sondes	6-3
6.4 Isco-Ready Sondes	6-4
6.5 Non-Isco-Ready SDI-12 Sondes	6-5
6.6 Sonde Setup - Storing Parameter Data	6-6
6.7 Sonde Calibration and Validation	6-7
6.7.1 Calibration Procedure	6-7
6.7.2 Validation Procedure	6-8
6.8 Disconnecting Sondes	6-8

## Section 7 Remote Operation

---

7.1 Computer Operation	7-1
7.1.1 Menu Control	7-2
7.1.2 External Program Control	7-4
7.1.3 Remote Control of Sampler Keypad	7-8
7.2 Telephone Commands	7-9

## Section 8 Maintenance

---

8.1 Maintenance Checklist	8-1
8.2 Cleaning Guidelines	8-1
8.2.1 Refrigerator	8-1
8.2.2 Controller	8-2
8.2.3 Cleaning or Replacing Wetted Parts	8-2
8.2.4 Air Filter	8-2
8.2.5 Condenser	8-2
8.3 Maintenance Screens	8-3
8.3.1 Set Clock	8-3
8.3.2 Pump Tube Alarm	8-4
8.3.3 Internal Battery Warning	8-5
8.3.4 Diagnostics	8-6
8.4 Replacing the Pump Tube	8-7
8.4.1 Checklist For Replacing Pump Tube	8-8
8.5 Opening the Controller Case	8-11
8.6 Replacing the Desiccant	8-11
8.7 Replacing the Internal Battery	8-13
8.8 Error Messages	8-15
8.9 Pump Tube Warning	8-15
8.10 Servicing the Refrigerator	8-16
8.10.1 Electrical System	8-16
8.11.2 Refrigeration System	8-19

## Appendix A Menu Flowcharts

---

## Appendix B Material Safety Data Sheets

---

## Appendix C General Safety Procedures

---

C.1 Practical Safety Precautions .....	C-1
C.1.1 Hazards .....	C-1
C.1.2 Planning .....	C-2
C.1.3 Adverse Atmospheres .....	C-2
C.1.4 Entering Manholes .....	C-2
C.1.5 Traffic Protection .....	C-3
C.1.6 Falling Objects .....	C-3
C.1.7 Removing the Covers .....	C-3
C.1.8 Other Precautions .....	C-3
C.1.9 Emergencies .....	C-4
C.1.10 Field Equipment .....	C-4
C.2 Lethal Atmospheres in Sewers .....	C-4
C.3 Hazardous Gases .....	C-6

## Appendix D Replacement Parts List

---

D.1 Replacement Parts Diagrams and Listings .....	D-1
---	-----

## Appendix E Accessories List

---

E.1 Order Information .....	E-1
E.2 Samplers .....	E-1
E.3 Bottle Kits .....	E-1
E.4 Bottle Racks, Retaining Rings, Discharge Tubes, Distributor Arm .....	E-2
E.5 Bulk Sets of Bottles with Lids .....	E-2
E.6 Pump Tubes, Suction Line, Strainers .....	E-3
E.7 Data Collection Devices and Cables .....	E-3
E.8 12-Volt Power Sources .....	E-4
E.9 Modules, Rain Gauges, & Interfacing Instruments .....	E-4
E.10 SDI-12 Data Acquisition Connect Cables .....	E-4

## List of Figures

---

1-1 Software Update window .....	1-4
2-1 Mounting the Controller .....	2-2
2-2 Installing the Bottle Racks .....	2-5
2-3 Installing the 24-bottle, 12-bottle, and 8-bottle Kits .....	2-5
2-4 Installing the 2-bottle Kit .....	2-6
2-5 Attaching the suction line to the pump tubing .....	2-7
2-6 Identifying the Sampler Components .....	2-9
3-1 Menu Tree for Standard Programming .....	3-11
4-1 Sample Distribution .....	4-7
4-2 Start Time Diagram .....	4-10
4-3 Running a Program .....	4-11
4-4 Taking a Grab Sample .....	4-15
4-5 Report: Program Settings .....	4-23
4-6 Report: Sampling Results .....	4-24
4-7 Report: Combined Results .....	4-25
4-8 Report: Combined Results (continued) .....	4-26
4-9 Report: Summary .....	4-27
5-1 Sample Distribution .....	5-18
5-2 Factors Affecting Flow-Weighted Variable-Volume Samples .....	5-20

5-3	Variable-Volume Scenario	5-21
5-4	Start Time Diagram for Sampler Enable Settings	5-23
5-5	Event Mark Timing Diagram	5-31
5-6	Password Protected Functions	5-35
6-1	Teledyne Isco AQ700 Multi-Parameter Sonde	6-1
7-1	Press and hold ?? to connect to the sampler	7-2
7-2	Example list of remote menu commands	7-2
8-1	Removing and Replacing the Pump Tube	8-9
8-2	Placing the Pump Tube in the Liquid Detector	8-10
8-3	Opening the Controller	8-12
8-4	Main Circuit Board Connections	8-13
8-5	Rear View of the 6712FR	8-16
8-6	Thermostat Logic Circuit Board	8-17
8-7	Control Box Wiring	8-17
8-8	Control Box Connections	8-17
8-9	Refrigeration System Schematic	8-20
A-1	6712 Menu Tree for Standard Programming	A-1
A-2	Standard Programming: Programming Screens	A-2
A-3	Standard and Extended Programming: Start Times	A-3
A-4	Standard Programming: Quick View; Programming Screens	A-4
A-5	Standard Programming: Quick View; Start Times	A-5
A-6	View Report	A-6
A-7	Maintenance Screens	A-7
A-8	Manual Functions Screens	A-8
A-9	Extended Programming: Programming Screens	A-9
A-10	Extended Programming: Equipment Setup	A-10
A-11	Extended Programming: Pacing and Distribution	A-11
A-12	Extended Programming: Event Conditions	A-12
A-13	Extended Programming: Programmed Sampler Enable	A-13
A-14	Extended Programming: Quick View; Programming Screens	A-14
A-15	Extended Programming: Quick View; Equipment Set-Up	A-15
A-16	Extended Programming: Quick View; Pacing and Distribution	A-16
A-17	Extended Programming: Quick View; Programmed Sampler Enable	A-17
A-18	Extended Programming: Normal View; Software Options	A-18
A-19	Extended Programming: Quick View; Software Options	A-19
A-20	Extended Programming: Normal View; Hardware	A-20
A-21	Extended Programming: Quick View; Hardware	A-21
A-22	Analog and Dialout Screens	A-22
A-23	Analog Output and Dialout Quick View Screens	A-22
A-24	SDI-12 Sonde Screens	A-23

## List of Tables

---

1-1	6712FR Sampler Features	1-5
1-2	6712FR Sampler Construction Materials	1-9
1-3	Technical Specifications for the 6712FR Refrigerated Sampler	1-10
1-4	Connector Specifications	1-16
2-1	Distributor Arm Positions and Discharge Tube Lengths for Bottle Kits	2-3
2-2	Selecting the Right Strainer	2-8
2-3	Connecting Isco Instruments to the Sampler	2-12
3-1	About the Keypad	3-2
4-1	Standard Program: Sample Every 15 Minutes, One Sample Per Bottle	4-2
4-2	Standard Program: Flow-Paced Sampling, Two Bottles Per Sample	4-3
4-3	Reports: Program Events, Source Codes, and Error Codes	4-21
4-4	Programming Example With 730 Module Installed	4-29
4-5	Programming Example With 750 Module Installed	4-31
5-1	Selecting a Stored Extended Program	5-3

5-2 Storm Water Runoff Sampling .....	5-6
5-3 Event Paced Sampling .....	5-13
5-4 Sampler Enable .....	5-24
5-5 Serial Data Codes .....	5-33
6-1 SDI-12 Sonde Parameters .....	6-3
7-1 6712 Remote Menu Commands .....	7-3
7-2 Serial Data Codes .....	7-6
7-3 Remote Control of Sampler Keypad .....	7-8
7-4 6712 Remote Phone Commands .....	7-9
8-1 Setting the Clock and Calendar .....	8-3
8-2 Resetting the Pump Counter .....	8-4
8-3 Checking and Replacing the Internal Battery .....	8-5
C-1 Hazardous Gases .....	C-6





# 6712FR Refrigerated Sampler

---

## *Section 1 Introduction*



6712 Controller

### **1.1 About This Manual**

The 6712FR Refrigerated Sampler is an integral part of Teledyne Isco's comprehensive sampling system. The system includes the 6712FR and 6712SR Refrigerated Samplers, the 6712 Compact Sampler, and the 6712 Standard Sampler.

The 6712FR is ideally suited for permanent installation in a wide variety of indoor and outdoor environments. Constructed from durable, corrosion resistant materials, the 6712FR withstands the hostile environments of industrial and municipal monitoring sites. However, do not install in locations where the refrigerator's lower compartment could become submerged.

The 6712FR accepts a variety of sequential and composite bottle kits. Like all samplers in the 6712 series, it is compatible with a variety of Isco instruments.

This manual contains the information you will need to install, program, operate, and maintain a 6712FR refrigerated sampler. There are eight sections and five appendices:

- *Section 1, Introduction* lists the features and specifications of the 6712FR refrigerated sampler.
- *Section 2, Installation / Preparation* steps you through installing the sampler and preparing it for use.
- *Section 3, Getting Started* describes features that are common to both standard and extended programming modes.
- *Section 4, Standard Programming* shows how to program your sampler using standard programming mode.
- *Section 5, Extended Programming* shows how to program your sampler using extended programming mode.
- *Section 6, SDI-12 Sondes* provides information on setting up sondes to work with the 6712FR.
- *Section 7, Remote Operation* explains how the 6712 controller can be operated remotely from external devices.
- *Section 8, Maintenance* covers the basic maintenance required to keep your sampler in top operating condition.

The appendices are:

- *Appendix A, Menu Flowcharts*
- *Appendix B, Material Safety Data Sheets*
- *Appendix C, General Safety Procedures*
- *Appendix D, Replacement Parts*
- *Appendix E, Accessories List*

## **1.2 About 700 Series Modules**

The bay on the controller's side accepts any of Teledyne Isco's 700 Series Modules. The 700 Series includes:

- 701 pH Parameter Module for monitoring pH and temperature.
- 720 Submerged Probe Module for monitoring a flow stream's level and flow rate with a submerged probe.
- 730 Bubbler Flow Module for monitoring a flow stream's level and flow rate with a bubbler system.
- 750 Area Velocity Module for monitoring a flow stream's level, velocity, and flow rate.
- 780 4-20mA Input Module for interfacing to non-Isco devices with 4 to 20 milliampere output signals.

The modules are optional accessories, and are not required for operation. However, the modules offer a number of advantages: they are an economical way to combine flow rate or parameter monitoring with sampling, and you can program the samplers and modules as a single unit. Finally, the samplers store the readings in memory.

## **1.3 SDI-12 Sondes**

As an option, the sampler accepts up to 16 parameters from up to ten sensors with SDI-12 addresses from 0 - 9 (refer to SDI-12 Sonde Readings, page 1-13, for specific parameters).

The data parameters used by the sonde and sampler must match. Some sondes have "plug and play" setup. Known as "Isco Ready," these sondes can tell the sampler what values they have, their order, and units of measure. Other sondes can still be used, but require manual setup to identify proper data types for each data value reported.

## **1.4 Telephone Communication**

Several remote communication options are available for the 6712 sampler. These include both landline and cellular communication. Remote phone communication enables alarms, data retrieval, and sampler control for remote sites. Cellular modems allow the sampler to send and receive SMS text messages.

### **1.4.1 4200T Landline Modem**

The 6712 controller can be ordered with a factory-installed 2400 baud dialout modem. Data retrieval is accomplished using Flowlink software.

### **1.4.2 GSM Cellular Modem**

CSD service for GSM technology is only available in limited areas. Contact Teledyne Isco before ordering the GSM modem. Samplers using this modem must have software version 2.34 installed. Refer to Section 1.4.5 for details.

- 1.4.3 CDMA Cellular Modem for CSD** The CDMA Anydata Cell Phone modem for Circuit-Switched Data (CSD) communication is no longer available from Teledyne Isco. Samplers still using this modem must have software version 2.34 installed. Refer to Section 1.4.5 for details.
- 1.4.4 6712Ci Modem** The 6712Ci is a CDMA cellular modem for serial communication via the internet. This modem requires a customer-supplied static IP address service contract with Verizon. Refer to Section 1.4.5 for details.
- 1.4.5 Software Compatibility** The 6712Ci cellular modem and 2105Ci cellular modem module work with 6700 Series/Avalanche samplers running software version **2.50** or later.
- The RTD (Rapid Transfer Device), GSM modem, and CDMA Anydata modem work with 6700 Series/Avalanche samplers running software version **2.34**.
- Software versions later than 2.50 will be compatible with the 6712Ci modem, 2105Ci Module, and RTD.
- The following instructions detail the steps for identifying your sampler's software version, downloading the required software, and installing it in the sampler controller.

<b>CAUTION</b>
----------------

Version 2.50 software should be installed only in samplers using the 6712Ci modem or pushing data with a 2105 modem module. This software disables the sampler's ability to communicate with the RTD (Rapid Transfer Device), GSM modem, and Anydata (CSD) modem.

*Identifying Your Software Version*

To determine if your sampler has the correct software installed for your application:

1. Turn the sampler on. From the home screen, select VIEW REPORT.
2. Select SYSTEM IDs.

The software version will appear in the list of IDs.

*Downloading 2.50 (or later) Software*

To download the correct version of software:

1. Go to Teledyne Isco's public website at [www.isco.com](http://www.isco.com).
2. In the left column, under **Service & Support**, click [Software/Firmware Updates](#).
3. In the center of the page, click **Automatic Water Samplers**, and then **6712-Avalanche software**.
4. Click [Updating Software Procedures](#). This PDF file provides step-by-step instructions for Installing software in Teledyne Isco instruments.
5. Select [6712-Avalanche 2.35+2.5 software](#), in your preferred language.

*Installing 2.50 (or later)  
Software*

6. Save the .zip file to a directory of your choice and extract the contents.

**CAUTION**

Updating the sampler's software will reset the program and memory partition settings to factory default settings, and may also erase stored data. Record settings and download data before proceeding.

1. Turn the sampler on and connect your computer to the interrogator port using either USB cable 60-2004-508 or serial port cable 60-2544-044.
2. Open the Update Software application, found in the program -> Flowlink 5.1 menu.
3. Follow the instructions provided in the PDF document Updating Software Procedures. The Help file in the application also contains these instructions.

**Note**

The downloaded files include software versions 2.34 and 2.50, software release notes for version 2.50, and a copy of the modem instruction sheet.

For Path to Files:, use the Select... button to browse to the files you downloaded. The software filename will have a .bin extension.

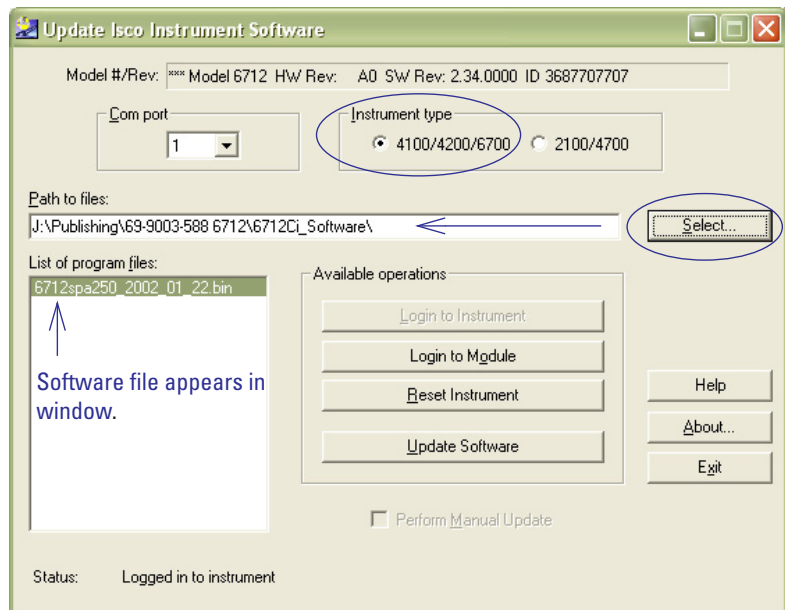

Figure 1-1 Software Update window

## 1.5 Memory to Store Monitoring Data

The samplers contain enough memory to store five sampling programs, sampling data, Isco 700 Series Module readings, and SDI-12 parameter readings. You can view the readings on your sampler's display.

You can also retrieve the readings and reports so the information can be processed on a personal computer. Readings and reports may be collected with a computer running Teledyne Isco's Flowlink® software. Flowlink can download the information through a direct connection, a modem connection (when the sampler is equipped with the optional dial-out modem or connected to the optional digital cellular modem), or from a 581 Rapid Transfer Device (RTD). The RTD is a quick and simple way to transfer the data from the field to your computer.

## 1.6 Pump Requirements

The pump also requires a pump tube made specifically for the 6712 and 6700 Series samplers. These pump tubes are easily recognized by their blue alignment collars. The 6712 pump tubing is the same as that for Teledyne Isco's 6700 Series samplers, but different from Teledyne Isco's earlier model samplers, such as the 3700 Series. **Other types of pump tubing will not work in the 6712FR.** Refer to *Replacing the Pump Tube* on page 8-7.

### CAUTION

This sampler has a high performance pump. As with all such pumps, it relies upon liquid to cool working components. If the sampler is programmed to pump in the absence of liquid in excess of 5 minutes, excessive heat buildup may damage the paddles, rollers, and housing. Ensure that the liquid inlet is completely immersed.

## 1.7 Features, Construction, and Specifications

**Table 1-1 6712FR Sampler Features**

General Features	
Top Cover	<ul style="list-style-type: none"> <li>• Protects pump, power source, and controller.</li> <li>• Lockable latches.</li> </ul>
Controller Only (does not include refrigerator)	<ul style="list-style-type: none"> <li>• Contains a rechargeable desiccant to prevent moisture damage to the electronics, pump, and distributor systems.</li> <li>• Control panel sloped 15 degrees for easy reading.</li> <li>• Keys labeled with large, vivid icons.</li> <li>• 80-character display (4 lines by 20 columns).</li> <li>• Display has selectable backlight: Always on or always off. Timed, switching off when keypad is inactive for 60 seconds.</li> <li>• Memory for program and data storage.</li> <li>• Flash memory for easy software upgrades.</li> <li>• NEMA 4X and 6 (IP67) ratings.</li> </ul>

**Table 1-1 6712FR Sampler Features (Continued)**

<b>Refrigerator</b>	<ul style="list-style-type: none"> <li>• The 6712FR requires 115 volts AC, 60 Hz, or optional 230 volts AC, 50 Hz. A built-in 12 volt DC power converter powers the controller.</li> <li>• The power supply and solid state thermostat are sealed inside the refrigerator's base. However, electrical connections for the fan and compressor are not sealed.</li> <li>• A forced air condensing coil and front ventilation let you place the unit close to a wall or in a corner.</li> <li>• The oversized wrap-around evaporator plate cools the sampling compartment quickly and efficiently. Heaters on the plate let the sampler continue to operate in cold temperatures. The evaporator plate is self-defrosting.</li> <li>• Food-grade ABS plastic interior will not support bacterial growth or leach plasticizers into the sample.</li> </ul>
<b>Adjustable Distributor Arm</b>	<ul style="list-style-type: none"> <li>• A single distributor arm adjusts quickly to fit all bottle kits. Easily removed for composite sampling.</li> </ul>
<b>Discharge Tube and Support Spring</b>	<ul style="list-style-type: none"> <li>• Routes sample liquid from pump tube, through distributor arm to sample bottle.</li> </ul>
<b>Composite Tube Guide for Composite Sampling</b>	<ul style="list-style-type: none"> <li>• Keeps discharge tube in place over composite bottles.</li> </ul>
<b>Compatible Isco Products</b>	<ul style="list-style-type: none"> <li>• 581 Rapid Transfer Device</li> <li>• 1640 Liquid Level Actuator</li> <li>• 2100 Series Flow Modules</li> <li>• Signature Series Flow Meters</li> <li>• 674 Rain Gauge</li> <li>• 700 Series Modules</li> <li>• 4100 Series Flow Loggers</li> <li>• SDI-12 Sondes</li> <li>• 4200 Series Flow Meters</li> <li>• Refrigerator Temperature Sensor</li> <li>• Flowlink,</li> </ul>
<b>Real-Time Displays</b>	<p>As the sampler runs a sampling program, it displays the program's status. The status display may include such information as the time of the next sample, the number of the next bottle, or whether the sampler is disabled or stopped. If the sampler encounters an error while running the program, it displays a message alerting you to the problem.</p>
<b>Programming for 700 Modules</b>	<p>Program the modules from the sampler's control panel. The module's program settings become part of the sampling program.</p>
<b>Setup for SDI-12 Sondes</b>	<p>Calibrate and program SDI-12 sondes from the sampler's control panel. The program settings become part of the sampling program. See Section 6.</p>
<b>Memory for Stored Programs and Readings</b>	<p>512 kilobytes of battery-backed RAM (Random Access Memory), to store:</p> <ul style="list-style-type: none"> <li>• Five sampling programs.</li> <li>• A sampling report from the most recently run program. It records as many as 1000 sampling events; events can be the program start time, enable time, sample event information, etc.</li> <li>• 700 Series module readings. The readings can be: level, flow rate, velocity, pH, temperature, or the data collected by the 4-20 mA module.</li> <li>• Rain gauge and refrigerator temperature readings.</li> <li>• SDI-12 sonde readings.</li> </ul>

**Table 1-1 6712FR Sampler Features (Continued)**

<b>Five Reports Available</b>	<ul style="list-style-type: none"> <li>• The Program Settings report, listing current program settings.</li> <li>• The Sampling Results report, listing the events occurring during the program.</li> <li>• The Combined Results report, combining sampling events with readings from a rain gauge, module, or SDI -12 sonde.</li> <li>• The Module Summary report, summarizing flow rate or parameter readings.</li> <li>• The Rainfall Summary report, listing a summary of rainfall readings.</li> </ul>
<b>Serial Data Output</b>	<ul style="list-style-type: none"> <li>• ASCII data output from the interrogator port.</li> </ul>
<b>Units of Measure</b>	A variety of metric and English units of measure for length, flow rate, flow volume, and temperature.
<b>External Sampler Enable</b>	Isco flow meters and flow loggers have a programmable sampler enable feature that lets them send an electronic signal to a 6712FR that enables (starts) or disables (stops) a running sampling program.
<b>Dual Sampler Mode</b>	Dual Sampler Mode operates two samplers.
<b>Command Driven Operation</b>	<ul style="list-style-type: none"> <li>• Operate sampler functions using RS-232 communications.</li> </ul>
<b>Warning Messages</b>	<ul style="list-style-type: none"> <li>• Pump Tube Warning. The 6712FR displays a warning to inspect the tube.</li> <li>• Internal Battery Warning. From the Maintenance screen, the 6712FR displays a warning when it is time to replace the internal battery. The internal battery preserves stored data when the 6712FR is without external power.</li> </ul>
<b>On-Line Help Notes</b>	When programming the sampler, press the [?] (Help) key for a brief help note. All help topics appear in the index.
<b>Two Programming Levels</b>	Standard programming lets you set up typical sampling programs quickly. Extended programming includes all features available in standard programming plus additional features.
<b>Sample Delivery System Features</b>	
<b>Peristaltic Pump</b>	<ul style="list-style-type: none"> <li>• <b>Benefits:</b> Liquid moves continuously under pumped flow. The pump has no metering chambers or gravity fed internal tubing to trap sediment or residual liquid. Sample liquid contacts only the strainer, suction line, tube coupling, pump tube, bulkhead fitting, and sample bottles.</li> </ul>
<b>LD90 Liquid Detector</b>	<ul style="list-style-type: none"> <li>• <b>Non wetted Detection:</b> Sample liquid never touches the detector.</li> </ul>
<b>Two Line Purges in Sampling Cycle</b>	The sampling cycle always includes a pre-sample purge and post-sample purge that clears the suction line of residual liquid.
<b>Easy Grab Samples</b>	Simply disconnect the pump tube from the bulkhead fitting on the center section, and place the pump tube over your sample container.
<b>Vinyl and PTFE Suction Lines</b>	<ul style="list-style-type: none"> <li>• 3/8-inch ID (Inside Diameter) vinyl line.</li> <li>• 3/8-inch ID PTFE lined with polyethylene jacket.</li> </ul>
<b>Standard Programming Features</b>	
<b>Pacing</b>	<ul style="list-style-type: none"> <li>• <b>Uniform Time Pacing:</b> Sampling at regular time intervals.</li> <li>• <b>Flow Pacing:</b> Sampling at regular flow-volume intervals.</li> </ul>



**Table 1-1 6712FR Sampler Features (Continued)**

<b>Distribution Methods</b>	<ul style="list-style-type: none"> <li>• <b>Composite:</b> Samples deposited in a single large bottle.</li> <li>• <b>Sequential:</b> Only one sample placed in each bottle.</li> <li>• <b>Samples Per Bottle:</b> Multiple samples placed in each bottle.</li> <li>• <b>Bottles Per Sample:</b> One sample deposited in multiple bottles.</li> </ul>
<b>Three Flexible Start-Time Settings</b>	<ul style="list-style-type: none"> <li>• <b>Start Immediately:</b> Starts the sampling program immediately.</li> <li>• <b>Delayed Start:</b> Starts the sampling program after a user-definable delay of 1 to 999 minutes.</li> <li>• <b>Clock Time:</b> Starts the sampling program at a user-definable time on one or more days of the week.</li> </ul>
<b>Option for a Continuous Running Program</b>	<ul style="list-style-type: none"> <li>• <b>Continuous Sampling:</b> When sample bottles are regularly replaced, the sample distribution can restart with the first bottle set after the last bottle set is filled, without interrupting the running program.</li> </ul>
<b>Extended Programming Features</b>	
<b>Pacing</b>	<ul style="list-style-type: none"> <li>• <b>Uniform Time Pacing:</b> Sampling at regular time intervals.</li> <li>• <b>Nonuniform Time Pacing:</b> Sampling at irregular time intervals.</li> <li>• <b>Random Interval Pacing:</b> Sampling at unique random time intervals generated by the controller.</li> <li>• <b>Flow Pacing:</b> Sampling at regular flow-volume intervals.</li> <li>• <b>Event Pacing:</b> Sampling each time a user-definable event occurs.</li> </ul>
<b>Flow Proportional Sample Volumes</b>	Allows for sample sizes to be based on flow. (This option is available only with uniform time pacing.)
<b>Distribution Methods</b>	<ul style="list-style-type: none"> <li>• <b>Composite:</b> Samples deposited in a single large bottle.</li> <li>• <b>Sequential:</b> Only one sample placed in each bottle.</li> <li>• <b>Samples Per Bottle:</b> Multiple samples placed in each bottle</li> <li>• <b>Bottles Per Sample:</b> One sample deposited in multiple bottles</li> <li>• <b>Multiple Bottle Compositing:</b> A combination of samples per bottle and bottles per sample distribution methods.</li> <li>• <b>Time Switched Bottles or Bottle sets:</b> Control the sample distribution using clock times.</li> </ul>
<b>Programmable Sampler Enable</b>	A 6712FR sampler can be programmed to enable or disable a running sampling program when readings received from a connected rain gauge, module, or SDI-12 Sonde meet certain conditions.
<b>Pauses and Resumes</b>	Create intermittent sampling schedules.
<b>Two-Part Programming</b>	Two-part programming lets you set up a sampling program that divides the bottles into two groups, filling each group according to separate pacing, distribution, sampler enable, and pause and resume settings. This is ideal for storm-water run-off sampling.
<b>Auto Suction Head or Fixed Suction Head</b>	<p>The suction head, is the vertical distance from the flow stream to the liquid detector. Extended programming has two settings.</p> <ul style="list-style-type: none"> <li>• <b>Auto-Suction Head:</b> The head is automatically determined.</li> <li>• <b>Fixed Suction Head:</b> A user-definable measurement for the head.</li> </ul>
<b>Suction Line Rinses</b>	Program setting for the number of times (0 to 3) that the 6712 rinses the suction line before drawing a sample.
<b>Sampling Retries</b>	Program setting for the number of times (0 to 3) that the 6712 attempts to sample if it fails to deliver the entire sample volume.



**Table 1-1 6712FR Sampler Features (Continued)**

<b>Three Flexible Start Time Settings</b>	<ul style="list-style-type: none"> <li>• <b>Run Immediately:</b> Starts the sampling program immediately.</li> <li>• <b>Delayed Start:</b> Starts the sampling program after a user-definable delay of 1 to 999 minutes.</li> <li>• <b>Clock Time:</b> Starts the sampling program at a user-definable time on one or more days of the week.</li> </ul>
<b>Option for a Continuous Running Program</b>	<b>Continuous Sampling:</b> When sample bottles are regularly replaced, the sample distribution can restart with the first bottle set after the last bottle set is filled, without interrupting the running program.

**Table 1-2 6712FR Sampler Construction Materials**

Item	Material
<b>Top Cover and Refrigerator Body</b>	Fiberglass reinforced plastic with ultraviolet-resistant gel coat.
<b>Plastic Retaining Rings</b>	ABS (Acrylonitrile Butadiene Styrene) plastic
<b>Controller Case Distributor Arm</b>	Noryl®
<b>Distributor Arm Nut Pump Rollers</b>	Delrin®
<b>Control Panel Connector Labels</b>	Polyester
<b>Distributor Shaft Pump Shaft Pump Paddles Pump Band Bulkhead Fitting Latches Metal Retaining Rings</b>	Stainless steel
<b>Refrigeration Tubing Protection</b>	Protected with polyester tubing or phenolic resin.
<b>Condenser Protection</b>	Powder coated with polyester.
<b>Evaporator Protection</b>	Powder coated with food-grade epoxy.
<b>Refrigerant</b>	R134a (1,1,1,2-tetrafluoroethane CH <sub>2</sub> FCF <sub>3</sub> )
<b>Insulation</b>	Polyurethane
<b>Amphenol Connectors</b>	Cadmium Plated Aluminum

**Table 1-3 Technical Specifications for the 6712FR Refrigerated Sampler**

General Notes:			
1. All weights may vary $\pm 1$ lb ( $\pm 1/2$ kg).			
2. All dimensions may vary $\pm 1/4$ inch ( $\pm 0.64$ cm).			
3. Sample delivery specifications valid for the following conditions and ranges, unless otherwise stated: 75°F (24°C) ambient, sample liquid–tap water at 50 to 80°F (10 to 27°C), sample volumes from 50 ml to 1000 ml, suction line lengths of 25 ft (7.6 m) or less, suction heads from 1 to 20 ft (0.3 to 6.1 m), atmospheric pressure between 29.92 and 31.89 inHg (760 and 810 mmHg), and a power source of an Isco High Capacity Power Pack at 12.5 volts DC no load output.			
6712 Controller, Pump, and Tubing: Mechanical Specifications			
<b>Weight of Controller:</b>	Controller only: 13.0 lbs (5.9 kg) With pump tube: 13.2 lbs (6.0 kg)		
<b>Weight of Nickel Cadmium Battery:</b>	4.3 lbs (2.0 kg)		
<b>Weight of Lead Acid Battery:</b>	5.7 lbs (2.6 kg)		
<b>Weight of Power Pack:</b>	6.0 lbs (2.7 kg)		
<b>Weight of Battery Backed Power Pack:</b>	6.6 lbs (3.0 kg)		
<b>Controller Dimensions:</b>	Length: 10.3 in (26.0 cm) Width: 12.5 in (31.7 cm) Height: 10 in (25.4 cm)		
<b>Temperature Ranges:</b>	Operational: 32 to 120 °F (0 to 49 °C) Storage: 0 to 140 °F (–18 to 60 °C)		
<b>Maximum Altitude:</b>	2,000 Meters		
<b>Installation Category:</b>	II		
<b>Pollution Degree:</b>	2		
<b>Humidity:</b>	95% RH Maximum		
<b>Enclosure:</b>	NEMA 4X and 6    Pump: IP17    Enclosure: IP67		
<b>Typical Delivered Volume Accuracy:</b>	(The ability to deliver the programmed sample volume.) $\pm 10$ ml or $\pm 10\%$ of programmed value, whichever is greater.		
<b>Typical Repeatability:</b>	(The ability to repeat the delivered volume for a set of samples collected under the same conditions.) $\pm 5$ ml or $\pm 5\%$ of the average of the maximum and minimum sample volume in a sample set, whichever is greater, at lifts up to 25 feet.		
<b>Typical Pump Flow Rate and Line Transport Velocity:</b>	Suction Head	Flow Rate	Line Transport Velocity
	3 feet	3.9 liters per minute	3.0 ft/s (0.91 m/s)
	5 feet	3.9 liters per minute	3.0 ft/s (0.90 m/s)
	10 feet	3.7 liters per minute	2.9 ft/s (0.87 m/s)
	15 feet	3.6 liters per minute	2.7 ft/s (0.83 m/s)
	20 feet	3.3 liters per minute	2.5 ft/s (0.77 m/s)
	23 feet	3.1 liters per minute	2.3 ft/s (0.71 m/s)
	25 feet	2.8 liters per minute	2.2 ft/s (0.66 m/s)
<b>Maximum Suction Head:</b>	(The maximum suction head is the vertical height at which a sample can be taken.) 28 ft (8.5 m) at 30 inHg (762 mmHg)		

**Table 1-3 Technical Specifications for the 6712FR Refrigerated Sampler (Contin-**

<b>Pump Tube Life:</b>	Tube life may vary depending on the abrasiveness of the sample liquid. Recommended maximum 1,000,000 pump counts. This equates to 912 standard samples. A standard sample is 200 ml at 5 ft (1.5 m) suction head using a 10 ft (3 m) vinyl suction line.
<b>6712 Controller: Electrical Specifications</b>	
<b>Controller Internal Battery:</b>	5 years minimum (maintains internal logic, program settings & stored data)
<b>Real Time Clock Accuracy:</b>	1 minute per month
<b>Program Memory:</b>	Nonvolatile programmable Flash. Can be field updated via interrogator connector.
<b>Sampler Power Requirements:</b>	Nominal: 12 volts DC supplied by the refrigerator Operational: 11 to 13 Volts DC Absolute Maximum: 14.4 Volts DC
<b>Power Pack Requirements:</b> Use only Isco-made power packs certified by UL. (P/N 60-1684-088)	115 VAC ±12VAC, 60 Hz., 1.0 Amp.  Note: This is the <b>only</b> version certified by UL. The line cord (mains connect cable) is the "Disconnect Device."

<b>Power Consumption<sup>a</sup></b>	
<b>6712 Controller in Standby</b>	10 mA
<b>Average Current of Accessories</b>	
Controller Display Backlight	228 mA
701 pH Module <sup>b</sup>	11 mA
710 Ultrasonic Module <sup>b</sup>	11 mA
720 Submerged Probe Module <sup>b</sup>	11 mA
730 Bubbler Module <sup>b</sup> — at 2 ft of liquid level — at 10 ft of liquid level	24 mA 31 mA
750 Area Velocity Module <sup>b</sup>	12 mA
780 4-20 mA Module <sup>b</sup>	10 mA
YSI 600 with pH, DO, Conductivity, and Temperature <sup>b</sup>	11 mA
Programmable Analog 4-20 mA Output Option <sup>c</sup>	124 mA
CDMA cellular telephone modem — standby current — current while communicating	35 mA 150 mA
GSM cellular telephone modem — standby current — current while communicating	62 mA 230 mA
<p>a. Current ratings when input power is 12.5 VDC and ambient temperature is 77 °F (25 °C)</p> <p>b. Average current when programmed to take readings at 15 minute intervals.</p> <p>c. Rating for three outputs.</p>	
<b>Sampler Only Operating Current:</b>	Approximately 30 mA based on 200 ml sample every hour, 10 ft (3 m) suction line, and 5 ft (1.5 m) suction head.

**Table 1-3 Technical Specifications for the 6712FR Refrigerated Sampler (Contin-**

Isco External Battery Capacity:	Number of Complete Standard Sampling Routines	
	Nickel-Cadmium Battery	Lead-Acid Battery
Sampler Only:	6	9
Sampler with pH Module:	6	9
Sampler with Ultrasonic Module:	6	9
Sampler with Submerged Probe Module:	6	9
Sampler with Bubbler Module (1-2 ft head):	3	5
Sampler with Area Velocity Module:	4	6
Sampler with 4-20 mA Module:	6	9

A Standard Sampling Routine is a 200 ml sample taken every hour in 24 bottle mode, with a 10 foot (3 m) vinyl suction line at 5 feet (1.5 m) of head. The module is set to take a reading every 15 minutes.

**Table 1-3 Technical Specifications for the 6712FR Refrigerated Sampler (Contin-**

<b>6712 Controller: Software Specifications</b>				
<b>Suction Line:</b>	Programmable 3 to 99 ft (1 to 30 m) lengths of: <ul style="list-style-type: none"> <li>• 3/8" (0.95 cm) I.D. Vinyl</li> <li>• 3/8" (0.95 cm) I.D. PTFE-lined with polyethylene jacket</li> </ul>			
<b>Sample Frequency:</b>	<ul style="list-style-type: none"> <li>• From 1 minute to 99 hours and 59 minutes in 1 minute increments between consecutive samples.</li> <li>• Nonuniform times in minute intervals or clock time</li> <li>• Random time intervals between consecutive samples</li> <li>• From 1 to 9,999 flow pulses in single-pulse intervals</li> <li>• Flow paced in volume with attachable flow module</li> </ul>			
<b>Rainfall Reading Units:</b>	Inches or millimeters			
<b>Module Readings:</b>	<b>pH</b>	8 bits representing pH	0.1 pH storage resolution	
		16 bits representing temp.	0.1 °C storage resolution	
	<b>Ultrasonic<sup>a</sup></b>	16 bits representing level	0.0001 m storage resolution	
	<b>Submerged Probe</b>	16 bits representing level	0.0001 m storage resolution	
	<b>Bubbler</b>	16 bits representing level	0.0001 m storage resolution	
	<b>Area Velocity</b>	16 bits representing level	0.0001 m storage resolution	
		16 bits representing velocity	0.001 ft/s storage resolution	
	<b>4–20 mA</b>	16 bits representing percent	0.1% storage resolution	
		16 bits representing level		
		32 bits representing flow		
<b>SDI-12 Sonde Readings:</b>	<b>Parameter</b>	<b>Range</b>	<b>Resolution</b>	<b>Storage Bytes</b>
	Temperature	-40 - 100 °C	0.1 °C	2
	Conductivity	0 - 100 mS/cm	0.01 mS/cm	2
	Specific Conductance	0 - 100 mS/cm	0.01 mS/cm	2
	Total Dissolved Solids	0 - 90 g/l	0.01 g/l	2
	Salinity	0 - 70 ppt	0.1 ppt	2
	Dissolved Oxygen	0 - 20 mg/l	0.1 mg/l	1
	pH	0 - 14	0.1	1
	ORP	-999 - 999 mv	0.1 mv	2
	Level	0 - 6.5279 m	0.0001 m	2
	Ammonium-Nitrogen	0 - 200 mgN/l	0.1 mgN/l	2
	Ammonia-Nitrogen	0 - 200 mgN/l	0.1 mgN/l	2
	Nitrate-Nitrogen	0 - 200mgN/l	0.1 mgN/l	2
	Turbidity	0 - 5000 NTU	0.1 NTU	2
	Chloride	0 - 1000 mg/l	0.1 mg/l	2
	Chlorophyll	0-400 ug/l	0.1 ug/l	2
	Other	-99999.0-99999.0	0.0001	4

**Table 1-3 Technical Specifications for the 6712FR Refrigerated Sampler (Continued)**

<p><b>Module Reading Conversions:</b></p>	<ul style="list-style-type: none"> <li>• Level and 4–20 mA readings converted to flow rate units:  <table style="width: 100%; border: none;"> <tr> <td style="width: 50%;">gallons per second</td> <td style="width: 50%;">gallons per minute</td> </tr> <tr> <td>million gallons per day</td> <td>cubic feet per second</td> </tr> <tr> <td>cubic meters per second</td> <td>cubic meters per hour</td> </tr> <tr> <td>cubic meters per day</td> <td>liters per second</td> </tr> </table> </li> <li>• Velocity units:  <table style="width: 100%; border: none;"> <tr> <td style="width: 50%;">feet per second</td> <td style="width: 50%;">meters per second</td> </tr> </table> </li> <li>• Totalized flow units:  <table style="width: 100%; border: none;"> <tr> <td style="width: 50%;">gallons</td> <td style="width: 50%;">million gallons</td> </tr> <tr> <td>cubic feet</td> <td>cubic meters</td> </tr> <tr> <td>liters</td> <td></td> </tr> </table> </li> <li>• Devices supported in flow conversion:                      Weirs: V-notch; 22.5, 30, 45, 60, 90, and 120 degrees                      Rectangular; with and without end contractions                      Cipoletti.                      Flumes: Parshall; 1", 2", 3", 6", 9", 1.5', 2', 3', 4', 5', 6', 8', 10', 12'                      Palmer-Bowlus; 4", 6", 8", 12", 15", 18", 21", 24", 27", 30", 48"                      Trapezoidal; LG 60 V, 2" 45 WSC, 12" 45 SRCRC                      H; 0.5', 0.75', 1', 1.5', 2', 2.5', 3', 4.5'                      Equation: <math>Q = a \times H^{b+c} \times H^d</math>                      where:                      Q = flow                      H = head                      a, b, c, and d = entered values                      Manning Formula: Round, U-channel, Rectangular, Trapezoidal                      Area Velocity: Round, U-channel, Rectangular, Trapezoidal                      Data Points: 50 level-flow rate points, 50 level-area points                 </li> </ul>	gallons per second	gallons per minute	million gallons per day	cubic feet per second	cubic meters per second	cubic meters per hour	cubic meters per day	liters per second	feet per second	meters per second	gallons	million gallons	cubic feet	cubic meters	liters	
gallons per second	gallons per minute																
million gallons per day	cubic feet per second																
cubic meters per second	cubic meters per hour																
cubic meters per day	liters per second																
feet per second	meters per second																
gallons	million gallons																
cubic feet	cubic meters																
liters																	
<p><b>Refrigerator Temperature Sensor</b></p>	<p>Optional sensor and 5 ft (1.55 m) cable to record temperature readings. Intended for use with fiberglass refrigerated (FR) samplers.                      Range: -40.0 °C to 100 °C                      Accuracy specification: ±0.3 °C over a range of 0.0 to 10.0 °C.                      Reading data is 2 bytes, with a storage resolution of 0.1 °C.</p>																
<p><b>6712FR Refrigerated Sampler: Physical Specifications</b></p>																	
<p><b>Dimensions:</b></p>	<p>Height: Top cover closed: 49.25 in (125 cm)                      Top cover open: 59.25 in (150.5 cm)                      Width: 26 in (66 cm)                      Depth: 26 in (66 cm)</p>																
<p><b>Bottle Configurations:</b></p>	<ul style="list-style-type: none"> <li>• 24 wedge polypropylene bottles, 1,000 ml</li> <li>• 24 round glass bottles, 350 ml</li> <li>• 12 wedge polyethylene bottles, 2.5 liters</li> <li>• 8 round polyethylene bottles, 2.0 liters</li> <li>• 8 round glass bottles, 1.8 liters</li> <li>• 2 rectangular polyethylene bottles, 7.5 liters (2 gal)</li> <li>• 2 round glass bottles, 9.4 liters (2.5 gal)</li> <li>• 1 round polyethylene bottle, 9.4 liters (2.5 gal)</li> <li>• 1 round glass bottle, 9.4 liters (2.5 gal)</li> <li>• 1 round polyethylene bottle, 15 liters (4 gal)</li> <li>• 1 round polyethylene bottle, 20.5 liters (5.5 gal)</li> <li>• 1 round glass bottle, 18.5 liters (5.0 gal)</li> </ul>																

**Table 1-3 Technical Specifications for the 6712FR Refrigerated Sampler (Contin-**



<b>Dry Weight:</b>	145 lbs (66 kg) Refrigerator only, no controller or bottle configuration 160 lbs (73 kg) Includes refrigerator, controller, top cover, center section, tub, pump tube, distributor shaft extension, distributor arm and nut, and discharge tube for the 24 plastic bottle configuration. NOTE: 230V refrigerator is 150 lbs (69kg) for serials 216M or later. All listed dry weights will increase by 5 lbs (3 kg) for the 230V version.	
<b>Dry Weight With:</b>	24 plastic bottles, rack, hold down, no caps 175 lbs(79 kg) 24 glass bottles, rack, expander ring, no caps 195 lbs(88 kg) 12 plastic bottles, rack, hold down, no caps 175 lbs(79 kg) 8 plastic bottles, rack, adaptor, no caps 170 lbs(77 kg) 8 glass bottles, rack, adaptor, no caps 180 lbs(82 kg) 2 plastic bottles, rack, no caps 175 lbs(79 kg) 2 glass bottles, rack, no caps 165 lbs(75 kg) 1-9.4 l plastic bottle and cap, no distributor arm or nut 165 lbs(75 kg) 1-9.4 l glass bottle and cap, no distributor arm or nut 170 lbs(77 kg) 1-15.0 l plastic bottle and cap, no distributor arm or nut 165 lbs(75 kg) 1-20.5 l plastic bottle and cap, no distributor arm or nut 165 lbs(75 kg) 1-18.5 l glass bottle and cap, no distributor arm or nut 170 lbs(77 kg)	
<b>Filled Bottle Weight:</b>	24 plastic bottles 101 lbs (46 kg) 24 glass bottles 104 lbs (48 kg) 12 plastic bottles 89 lbs (41 kg) 12 glass bottles 95 lbs (43 kg) 8 plastic bottles 84 lbs (38 kg) 8 glass bottles 90 lbs (41 kg) 4 plastic bottles 98 lbs (45 kg) 4 glass bottles 104 lbs (48 kg) 1 plastic bottle 90 lbs (41 kg) 1 glass bottle 94 lbs (43 kg)	
<b>Average Thermal Resistance Factor:</b>	R-16 The average R-value for a complete FR refrigerator not running	
<b>Recovery time</b>	5 minutes	
Recovery time is the time for the internal air temperature to return to 39°F (4°C) after the door has been opened for one minute. The empty refrigerator is running and set at 39°F (4°C). The door is opened at least 4 minutes after the compressor has turned on. Ambient air temperature is 75°F (24°C).		
<b>Thermostat</b>	Set point range: 32° to 46°F (0° to 8°C) Set point accuracy: ±1.8°F (±1°C) at 39°F (4°C) [With an ambient air temperature of 75°F (24°C)]	
<b>Temperature Ranges</b>	Operational: -20° to 120°F (-29° to 49°C) Storage: 0° to 140°F (-18° to 60°C)	
<b>Environment</b>	Rain and spray resistant, but not watertight. Do not install in locations where the refrigerator's lower compartment could become submerged.	
<b>Electrical</b>	Power Requirements: 115 Volts, 60 Hz 230 Volts, 50 Hz (optional)  Running current: 3.5 amp 1.6 amp Starting current: 17 amp 11 amp Stalled Compressor current: 21 amp 17 amp (maximum)	

**Table 1-3 Technical Specifications for the 6712FR Refrigerated Sampler (Contin-**

<b>Heater Capacity</b>	60 watts
<b>Compressor</b>	1/5 HP (150W) Tecumseh compressor. 230V serials after 216M are 175W.
<b>Compressor Protection</b>	Temperature safety cutout that will disengage the compressor if the compressor reaches 221°F (105°C). 230V serials after 2016M cutout will engage at 248 °F (120 °C).
<b>Refrigerant</b>	R134a, 4.5 ounce charge
<b>Pressure</b>	High side: 165 to 215 psig (1.14 to 1.48 MPa) Low side: 2 to 10 psig (13.8 to 69 kPa)

a. The 710 Ultrasonic Module and sensor have been discontinued as of August 17, 2012.

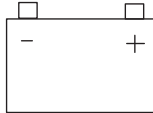
**Table 1-4 Connector Specifications**

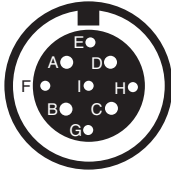
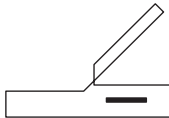
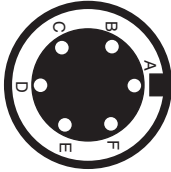
Connector Icon	Pin Location Diagram	Pin Function
<p><b>POWER SOURCE</b></p> 	<p><b>2-PIN MALE, SEALED</b></p> 	<p>A Ground B +12 volts DC</p>
<p><b>RAIN GAUGE</b></p> 	<p><b>9-PIN FEMALE, SEALED</b></p> 	<p>A +12 volts DC B Ground C 5V Programmable I/O1 pin D Rain gauge input E 12V switched F SDI-12 Data recv G SDI-12 Transmit H 5V Programmable I/O2 pin I 5V Programmable I/O3 pin</p>
<p><b>INTERROGATOR</b></p> 	<p><b>6-PIN FEMALE, SEALED</b></p> 	<p>A Switched +12 volts DC B Ground C Connection Sense D Transmit E Receive F NC</p>

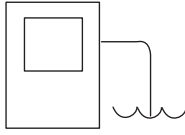
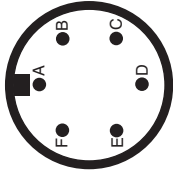
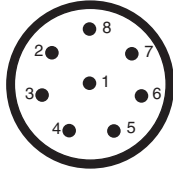

**Table 1-4 Connector Specifications (Continued)**

Connector Icon	Pin Location Diagram	Pin Function
<p><b>FLOW METER</b></p> 	<p><b>6-PIN MALE, SEALED</b></p> 	<p>A +12 volts DC            B Ground            C Flow Pulses In            D Bottle Number Out            Dual Sampler Out            E Event Mark Out            F Inhibit In</p>
<p><b>MODULE</b> (IN MODULE BAY)</p>	<p><b>8-PIN MALE, SEALED</b></p> 	<p>1 NC            2 +12 volts DC            3 Ground            4 Module Sense            5 Receive            6 Transmit            7 Clock            8 Control</p>



# 6712FR Refrigerated Sampler

---

## *Section 2 Installation/Preparation*

**2.1 Preparing the Sampler** The 6712FR is shipped to you with the controller mounted on the refrigerator and a distributor shaft extension installed. Use Figure 2-1 for reference when removing the controller. You must remove the controller when:

- The internal desiccant needs recharging, the internal battery needs to be replaced or when the controller needs repair.
- You install a different bottle kit.

Each bottle kit has its own extension so that the distributor arm is positioned at the right distance above the bottles. You must remove the controller to replace the extension.

### **2.1.1 Installing the Distributor Shaft Extension**

1. Install the extension before mounting the controller on the refrigerator.
2. Select the extension of the correct length for the bottle kit, and screw it on the distributor shaft. Secure it with the set screw. See Figure 2-1.

**BE SURE THE SET SCREW IS TIGHTENED INTO THE DISTRIBUTOR SHAFT'S KEY. YOU MAY HAVE TO LOOSEN THE EXTENSION SLIGHTLY AND ADJUST ITS POSITION.**

### **2.1.2 Mounting the Controller**

1. Install the four mounting rods into the bosses on the bottom of the case.
2. Fit the mounting rods through the four holes drilled in the top of the refrigerator.
3. Slip a washer on each rod and secure the controller by tightening the wing nuts.
4. Install the distributor arm and discharge tube.
5. Thread the stop arm into the hole in the side of the extension. Be sure the stop arm is directly above the distributor arm.
6. Connect the power cable to the controller.

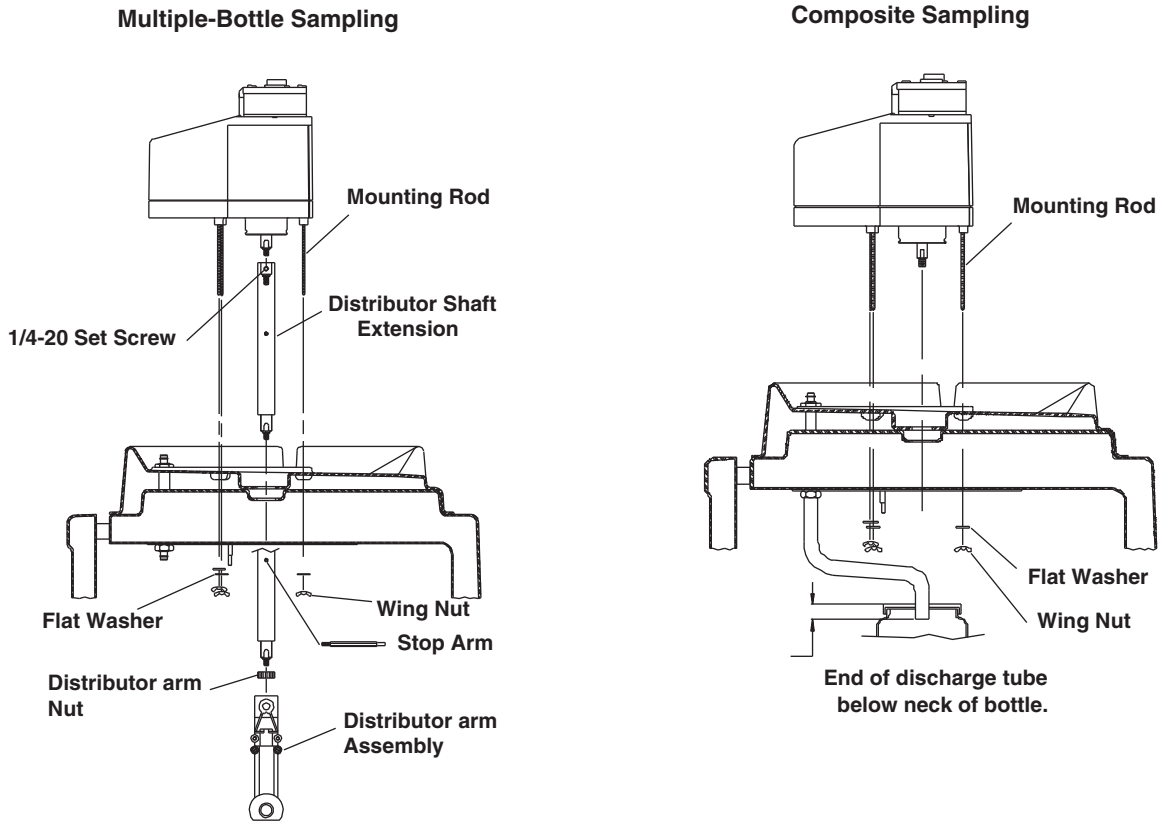
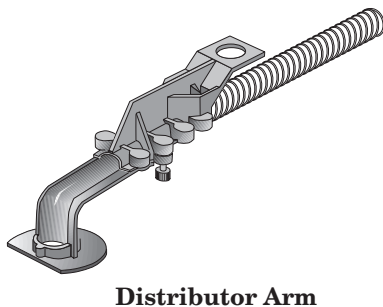

Figure 2-1 Mounting the Controller

### 2.1.3 Installing the Distributor Arm and Discharge Tube



Distributor Arm

The distributor arm is adjustable so that you can position the discharge tube over the bottles of each kit. Each bottle kit also uses a discharge tube of a specific length. Table 2-1 lists the correct discharge tube lengths for each bottle kit. If you are using bulk tubing to cut your own tubes, cut the ends of the tube square, not at an angle, and cut the length accurately.

The two-piece distributor arm has four positions, marked on the underside with the letters A, B, C, and D. Adjust the arm to the correct position for the bottle kit being used. Table 2-1 shows the correct position for each kit. Thread the discharge tube through the spring and arm so that the tube protrudes from the arm  $\frac{1}{16}$  to  $\frac{1}{8}$  inch. If too much tube protrudes from the arm it can catch on bottles and jam the distributor arm.

Attach the arm to the distributor shaft extension. Secure the arm to the extension with the black plastic nut. Slide the free end of the discharge tube onto the bulkhead fitting. After installing the distributor arm and discharge tube, run the distributor to each bottle position to ensure proper installation.

**Table 2-1 Distributor Arm Positions and Discharge Tube Lengths for Bottle Kits**

**24-Bottle Kits**

1000-milliliter polypropylene bottles  
350-milliliter glass bottles  
Distributor Arm Position: D  
Discharge Tube: 60-9003-279  
Discharge Tube Length: 20 inches (50.8 cm)  
Distributor Shaft: 60-9003-273  
Distributor Shaft Extension: 8<sup>1</sup>/<sub>16</sub> inches (22.0 cm)

---

**12-Bottle Kits**

2.5 liter polyethylene bottles  
Distributor Arm Position: D  
Discharge Tube: 60-9003-279  
Discharge Tube Length: 20 inches (50.8 cm)  
Distributor Shaft: 60-9003-273  
Distributor Shaft Extension: 8<sup>1</sup>/<sub>16</sub> inches (22.0 cm)

---

**8-Bottle Kits**

1.8 liter glass bottles  
2.0 liter polyethylene bottles  
Distributor Arm Position: B  
Discharge Tube: 60-9003-279  
Discharge Tube Length: 20 inches (50.8 cm)  
Distributor Shaft: 60-9003-274  
Distributor Shaft Extension: 10<sup>1</sup>/<sub>2</sub> inches (26.7 cm)

---

**2-Bottle Kits**

9.4 liter (2<sup>1</sup>/<sub>2</sub> gallon) glass bottles  
7.5 liter (2 gallon) polyethylene bottles  
Distributor Arm Position: A  
Discharge Tube: 60-9003-283  
Discharge Tube Length: 16 inches (40.6 cm)  
Distributor Shaft: 60-9003-275  
Distributor Shaft Extension: 6 inches (15.2 cm)

---

Composite Bottles	Discharge Tube	Discharge Tube Length
9.4 liter (2 <sup>1</sup> / <sub>2</sub> gallon) glass bottle	60-9003-262	17 <sup>1</sup> / <sub>4</sub> in (43.8 cm)
9.4 liter (2 <sup>1</sup> / <sub>2</sub> gallon) polyethylene bottle	60-9003-262	17 <sup>1</sup> / <sub>4</sub> in (43.8 cm)
15.0 liter (4 gallon) polyethylene bottle	60-9003-264	16 <sup>1</sup> / <sub>2</sub> in (41.9 cm)
18.5 liter (5 gallon) glass bottle	60-9003-266	15 <sup>3</sup> / <sub>4</sub> in (40 cm)
20.0 liter (5 <sup>1</sup> / <sub>2</sub> gallon) polyethylene bottle	60-9003-266	15 <sup>3</sup> / <sub>4</sub> in (40 cm)

---

## 2.2 Installing Bottle Kits

Teledyne Isco ships the refrigerator from the factory with the sample bottles in place. When using the sampler for the first time, you will only need to remove the bottle lids. When installing cleaned bottles or a new kit, keep these guidelines in mind:

- Do not mix glass and plastic bottles together.
- Install all bottles to insure that they remain in place.
- Align the racks correctly. If the racks are misaligned, the sampler may miss the bottle mouth, or the sampler will deposit samples in the “wrong” bottle.

Each time you change from one size bottle to another, you must adjust the length of the distributor arm, install a discharge tube of the correct length, and possibly install a different distributor shaft extension.

Each time you install a bottle kit, check the program settings for the number of bottles and bottle volumes. Also rotate the distributor arm to each bottle position to ensure the arm is correctly positioned over each bottle. Use the controller to move the arm.

### 2.2.1 Installing Racks

Install the bottle rack with bottles by sliding it into the cooling compartment until the rack drops over the two semicircular ramps which hold it in place (Figure 2-2).

The five posts and two ramps which position the rack under the distributor arm are adjusted at the factory. When you change bottle kits, you may need to readjust the stops and ramps and install a different distributor arm extension. Figures 2-3 and 2-4 show you how to install the bottle kits.

Check the kit’s alignment by rotating the distributor arm. **Do not rotate the distributor manually. Moving the arm manually damages the distributor drive.** If you see any misalignment, adjust the posts and ramps until the discharge tube at the end of the arm stops over each bottle.



**24-Bottle Kit**

1000-milliliter polypropylene bottles.



**2-Bottle Kit**

(Requires a locating base.)

*Figure 2-2 Installing the Bottle Racks*

Install the distributor shaft extension. Use the 8<sup>11</sup>/<sub>16</sub>-inch extension for the 12- and 24-bottle kits. Use the 10<sup>1</sup>/<sub>2</sub>-inch extension for the 8-bottle kit. The instructions on page 2-1 show you how to remove the controller and replace the extensions for each bottle kit.

Next, adjust the distributor arm to position D for the 12-bottle and 24-bottle kits, or to position B for the 8-bottle kit. Install the arm and stop. See Installing the Distributor Arm and Discharge Tube on page 2-2.

Slide the rack, with bottles installed onto the mounting plate. Adjust the stops and ramps on the plate so that the rack is centered and held firmly on the plate.

Finally, position the arm over each bottle. If the arm does not stop over each bottle, readjust the rack.

**NEVER MANUALLY ROTATE THE DISTRIBUTOR ARM.**

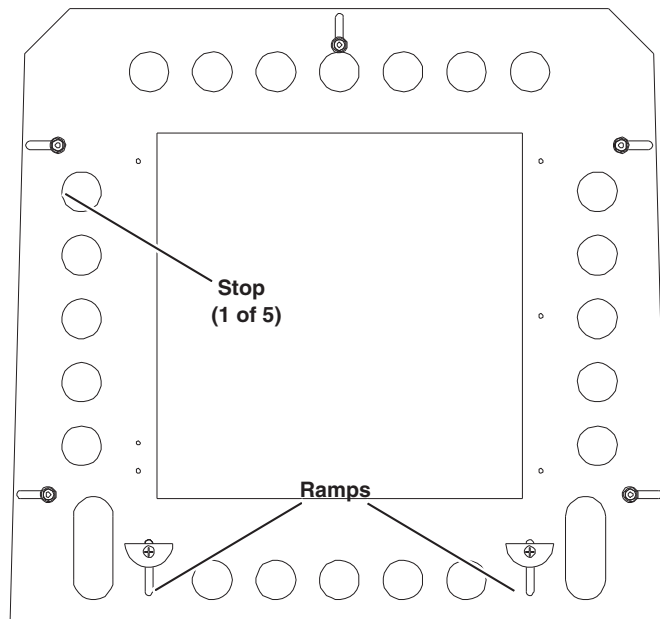

*Figure 2-3 Installing the 24-bottle, 12-bottle, and 8-bottle Kits*

Install the distributor-shaft extension. Use the 5 $\frac{1}{4}$ -inch extension for the 2-bottle kit. The instructions on page 2-1 show you how to remove the controller and replace the extensions for each bottle kit.

Next, replace the controller, and adjust the distributor arm to position A. Install the arm and stop. See Installing the Distributor Arm and Discharge Tube on page 2-2.

Install over the mounting plate at the bottom of the refrigerator, the locating base which holds the 2 $\frac{1}{2}$ -gallon glass or 2-gallon polyethylene bottles.

Begin by loosening the ramps. Move them toward the front of the compartment so that they will fit under the ridge of the locating base. (You can also remove them completely.)

Remove the two front stops, and align the holes on the sides of the locating base with the holes for the stops in the mounting plate. Secure the base by replacing the stops.

Install the bottles, and position the arm over each bottle.

**NEVER MANUALLY ROTATE  
THE DISTRIBUTOR ARM.**

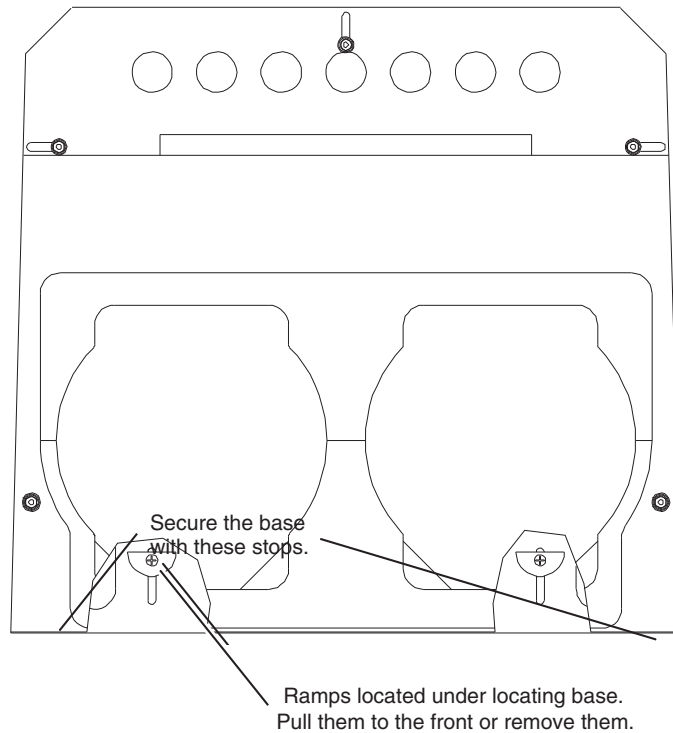

Figure 2-4 Installing the 2-bottle Kit

**2.2.2 Removing Racks**

Before removing the rack, place the lids on the bottles so the samples do not spill. Remove the bottle rack by lifting the front edge of the rack slightly to disengage it from the two ramps. Then, pull it straight out of the refrigerator. Be careful not to catch the distributor arm against the bottles.

**2.2.3 Installing Composite  
Bottles**

Remove the distributor arm and discharge tube. Remove the distributor arm stop. If using the two bottle locating base, remove it. Slide the composite bottle discharge tube on the bulkhead fitting. Composite bottle kits have two lids, one with a hole drilled in the center. Screw the lid with the hole in it on the bottle, and place the bottle in the center of the mounting plate.

Thread the discharge tube through the hole in the lid. Always use the lid to retain the discharge tube. It prevents the sampler from spraying liquid inside the sample compartment instead of the bottle.



## 2.3 Suction Line

The suction line is the tubing from the sampling point to the pump intake. The 6712FR uses a  $\frac{3}{8}$ -inch ID suction line of lengths 3 to 99 feet. Teledyne Isco offers vinyl or PTFE suction lines. The PTFE tubing has a polyethylene jacket to protect it from kinks and abrasions.

The vinyl line contains a very low parts-per-million level of phenols. If phenol content affects your sample analysis, use the PTFE suction line.

When installing the sampler, be sure the vertical distance between the liquid level and the pump is as small as possible.

### 2.3.1 Guidelines for Measuring and Cutting the Suction Line

- Cut the line to the desired length but use the shortest length feasible for the installation.
- Cut the line in 1 foot increments. For instance, 4 feet, not  $3\frac{1}{2}$ . If using metric units of measure, cut the line in increments of 0.1 meter. Do not include the length of the strainer in the measurement.

### 2.3.2 Attaching Suction Line to Pump Tube

Attach the vinyl suction line to the pump tube with the  $\frac{3}{8}$ -inch tubing coupler. First, screw the threaded end into the suction line until the flat surface is flush against the suction line (Figure 2-5). Then, push the other end of the coupler into the end of the pump tube until the other flat surface is flush against the tubing.

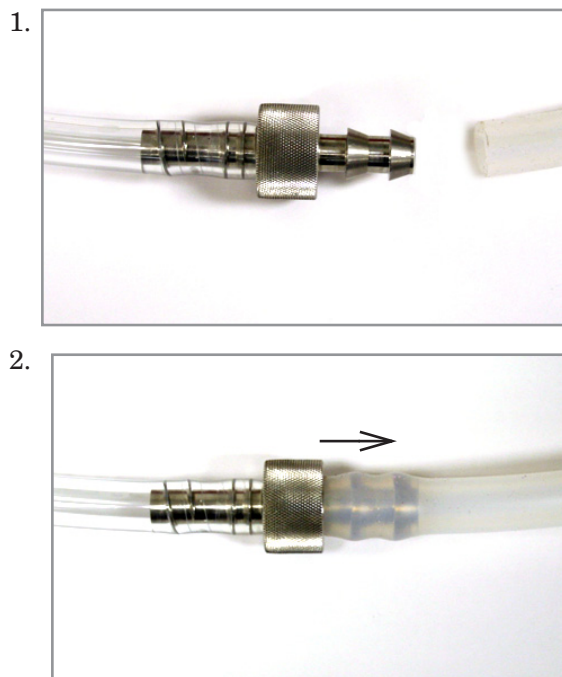

Figure 2-5 Attaching the suction line to the pump tubing

Once the coupler is attached to the pump tube, removal is difficult, and may require cutting the tube.

## 2.4 Strainers

Teledyne Isco offers three styles of strainer that help prevent solids from clogging the suction line:

- 3/8-inch standard weighted polypropylene strainer for routine and priority pollutant sampling
- 3/8-inch stainless steel low flow strainer
- Weighted CPVC-coated strainer for acidic liquid sources

To select the right strainer for your application, see Table 2-2.

To install the optional low flow strainer in PTFE suction line, heat the end of the suction line to make it more pliable, then carefully screw the strainer's threaded connector into the suction line.

### 2.4.1 Alternative to Strainers

When sampling from high velocity streams with heavy suspended solids, some field investigations suggest that more representative samples are obtained without the strainer. Consider attaching a short piece of thin walled aluminum tubing to the end of the suction line; anchor the tubing so that the inlet opens upstream. The aluminum tubing's thin wall will not disturb the flow stream, and most sample analyses disregard aluminum ions. Under most conditions, the pre-sample purge removes any debris over the tubing entrance.

**Table 2-2 Selecting the Right Strainer**

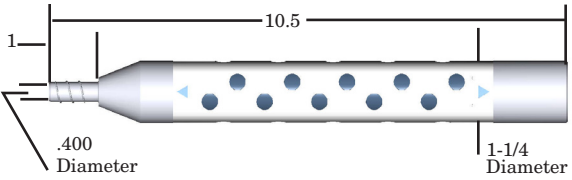
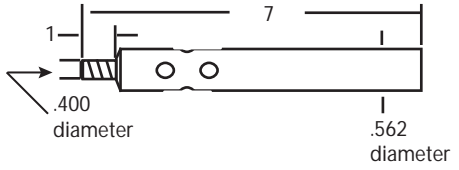
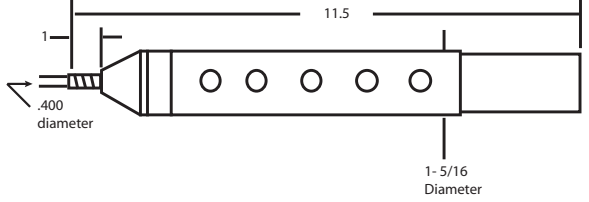
Strainer	Dimensions	Application	Maximum Depth
<b>3/8 Stainless Steel Ends, Polypropylene Center</b>		Routine applications.	Vinyl Line: 22 feet (6.7m). PTFE Line: 15 feet (4.5m).
<b>3/8 Stainless Steel Low Flow</b>		Low flow applications	Vinyl Line: 22 feet (6.7m). PTFE Line: 15 feet (4.5m).
<b>3/8 CPVC</b>		Highly acidic liquids.	Vinyl Line: 4 feet (1.2m).

**Note**

- The suction lines will float when filled with air during the purge cycles and when depths exceed the listed ratings. Secure the suction lines when sampling at depths exceeding the maximum ratings.
- All strainer dimensions are in inches.
- PTFE suction line is compatible only with the 3/8 stainless steel strainer.

## 2.5 How Does the Sampler Work?

When the sampler takes a sample, it draws liquid through the strainer and suction line to the pump tube. The liquid flows through the pump tube and past the liquid detector, which senses the liquid. From the detector, the liquid follows the pump tube through the pump to the bulkhead fitting and then through the discharge tube to the sample bottle.

A typical sampling cycle consists of:

1. The sampler moves the distributor arm over the bottle that is to receive the sample.
2. The pump reverses for the pre-sample purge.
3. The pump direction changes, filling the suction line.
4. When the detector senses liquid, the sampler begins measuring the sample.
5. After depositing the sample, the pump again reverses for the post-sample purge.

Sampling cycles vary somewhat according to program settings for distribution. The sampler can move the distributor arm clockwise and counterclockwise, making a number of distribution methods possible. (In this manual, the words “sample event” refer to a full sampling cycle for any distribution.)

- a. Controller.
- b. Peristaltic pump.
- c. Liquid Detector.
- d. Strainer
- e. Suction line
- f. Stainless Steel Coupling
- g. A pump tube routed from the liquid detector's intake port through the pump, out the detector's discharge port, and over the side of the controller to a bulkhead fitting.
- h. Bulkhead fitting.
- i. Discharge tube running from the bulkhead through the spring and distributor arm.
- j. Distributor arm and spring.

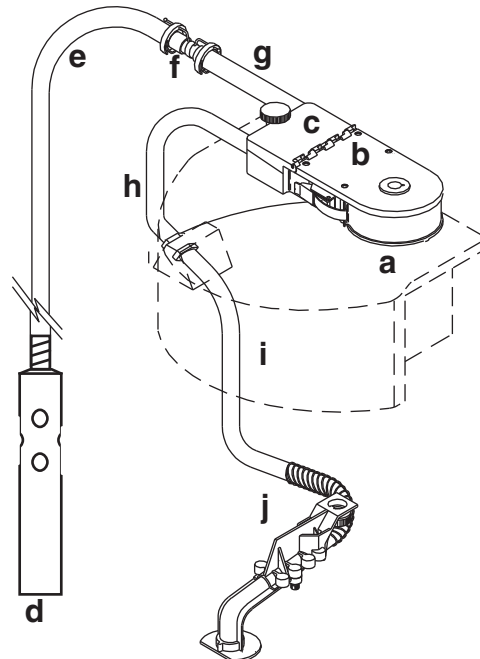

Figure 2-6 Identifying the Sampler Components

Other variations include extended-program settings for suction-line rinses and sampling retries. A sampler running a program with line rinses completes the pre-sample purge and

then rinses the line. The suction line is purged after each rinse. When programmed for sampling retries, the sampler will attempt to pump a sample again if it fails on previous attempts.

### 2.5.1 Measuring Sample Volume

“Sample volume” refers to the amount of liquid delivered into a bottle. The volume is determined by the programmed value. The volume is dependent on the volume per revolution of the pump, which is dependent on the suction head. The 6712FR delivers the sample by counting the pump revolutions and automatically compensating for the suction head.

## 2.6 Installing the Sampler

The following segment briefly describes initial sampler installation.

### CAUTION

Tests indicate that the pump produces sound levels in excess of 85db at one meter. Prolonged exposure to this sound could result in hearing loss and requires the use of protective ear plugs.

### CAUTION

When using the 6712FR sampler with a 750 or 710 module, transmitters such as cell phones or walkie talkies must not be operated within 3 meters of the sampler. If water level readings are fluctuating due to TV/radio station transmitter towers in the area, the sampler must be relocated.

### WARNING

**The 6712FR samplers have not been approved for use in hazardous locations as defined by the National Electrical Code.**

### WARNING

**If you must enter a manhole or other dangerous location to install the sampler, observe standard safety precautions. Refer to Appendix C for a discussion of safety considerations.**

### 2.6.1 Tips for Routing Suction Line

Route the line so that it runs continuously downhill from the sampler to the liquid source. This helps drain the line during pre-sample and post-sample purges. When the sampler is used in below freezing temperatures, there is a risk of the suction line being frozen. A suitably warm sampling source can usually prevent this, provided there are no loops in the suction line. Some situations may require more protective measures, such as insulation of the suction line, or heat tape. Thoroughly draining the suction line minimizes the possibility of frozen liquid clogging the line.

### 2.6.2 Intake Placement

For representative samples, place the intake in the main current of the flow stream, not in an eddy or at the edge of flow. Placing an intake at the bottom may produce samples with excess heavy solids and no floating materials, while placement at the top may produce the opposite conditions.

### 2.6.3 Positioning a Sampler

Place the refrigerator on a relatively flat, horizontal surface. Placing the refrigerator on a steep incline may cause the sample to miss the bottle mouth.

When installing the sampler, be sure the vertical distance between the level of the liquid and the pump is as small as possible.

#### CAUTION

Connect the refrigerator's line cord to mains power at an easily-accessible location. This allows the refrigerator to be disconnected easily if a fault condition occurs.

#### CAUTION

The refrigerator's lower compartment is not watertight. Do not install in a location where the refrigerator's lower compartment could become submerged.

## 2.7 Connecting External Instruments

The 6712FR sampler can be used in conjunction with several types of external instruments.

### 2.7.1 Flow Meter

To connect the sampler to an Isco open-channel flow meter, 4100 series flow logger, 2100 series flow module, or 1640 Liquid Level Actuator, attach the sampler-to-flow meter cable to the Flow Meter Connector. To connect the sampler to a closed-pipe flow meter, attach an Isco 4-20 mA Input Interface device to the sampler's Flow Meter connector. Plug the line cord into an AC power outlet. Be sure it is connected to 115 volts AC (optional 230 volts AC). When using the sampler with an external instrument, remember these guidelines:



- Both the sampler and the flow instrument must be on and running a program.
- If using a flow meter, logger, or module for flow pacing, the sampler and the flow instrument must both run programs with flow pacing settings.
- If using a flow meter or flow logger for trigger pacing, the sampler must run a program with flow pacing settings, and the flow instrument must run a program with trigger pacing settings.

- When the sampler runs an event-paced program, it disregards pacing pulses from a flow meter or flow logger. However, the sampler continues to monitor for enable signals.

### 2.7.2 Rain Gauge Connector

Attach the rain gauge, SDI-12 Sonde, or Refrigerator Temperature Sensor cable connector to the nine-pin Rain Gauge port. When connecting a rain gauge and an SDI-12 Sonde, or rain gauge and a Refrigerator Temperature Sensor, use the appropriate 'Y' cable. For part numbers and ordering information, see the Accessories appendix at the end of this manual.

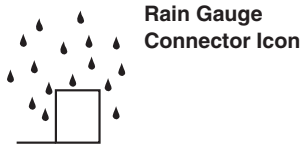

To operate with an SDI-12 sonde, the sampler must be placed in Extended Programming mode, and SDI-12 Sonde Setup must be selected from the Hardware Setup menu (refer to Section 5.18). For complete SDI-12 sonde setup instructions, refer to Section 6.



### WARNING

**Most Isco flow meters are not certified for use in hazardous locations as defined by the National Electrical Code. Contact your Teledyne Isco representative for your equipment's status. Never operate equipment in hazardous locations that has not been certified as safe for such use. Refer to Appendix C in the back of this manual for more safety information.**

**Table 2-3 Connecting Isco Instruments to the Sampler**

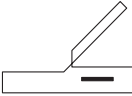
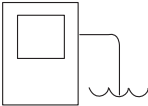
Connector Icon	Connect These Instruments:
<b>Power Source</b> 	12 volt power source
<b>Rain Gauge</b> 	674 Rain Gauge Programmable I/O Pins (pins C, H, and I) SDI-12 Sonde Refrigerator Temperature Sensor
<b>Interrogator</b> 	581 RTD (Rapid Transfer Device) IBM PC or compatible computer running FLOWLINK External Modem External Data Logger/Controller
<b>Flow Meter</b> 	1640 Liquid Level Actuator 2100 Series Flow Modules 3000 Series Flow Transmitters 4100 Series Flow Loggers 4200 Series Flow Meters Master/Slave Sampler Pulse Duration Input Interface 4-20 mA Input Interface Closed-Pipe Flow Meter (with 4-20 mA Input Interface)

## 2.8 Locking the Sampler

The refrigerator is equipped with a lockable latch for the top cover and a lockable catch for the door handle. To lock the refrigerator, use two padlocks, one for the top cover and one for the door.

## 2.9 Servicing the Sampler

Servicing the sampler includes:

- Collecting the filled sample bottles and replacing them with clean bottles;
- Collecting the data recorded by the sampler during the program.

Samplers are usually serviced after they complete a sampling program. When working up a service schedule, you will need to estimate the program completion time. You should also be familiar with the program's settings for the start time or if the sampler is programmed for continuous sampling.

Continuous sampling is controlled by the distribution setting entered at the "RUN CONTINUOUSLY?" screen. A "YES" response directs the sampler to reset the distribution sequence and continue the countdown to the next sample event. Appropriate service intervals will prevent overfilled bottles.





# 6712FR Refrigerated Sampler

## Section 3 Programming Introduction

Before programming the 6712FR, you should become familiar with its keys and how to use the screens.

The 6712FR Sampler has two sets of programming modes. The first mode, **Standard Programming**, lets you set up typical sampling programs easily and efficiently. The second mode, **Extended Programming**, lets you create sophisticated programs for complex sampling applications.

All of the sampling features available in standard programming mode are available in extended programming mode. However, extended programming provides many additional features.

Standard and extended programming features are explained in separate sections. This section focuses on some basic features that are common to both programming modes, such as using the menus and setting the clock.

### CAUTION

This sampler has a high performance pump. As with all such pumps, it relies upon liquid to cool working components. If the sampler is programmed to pump in the absence of liquid in excess of 5 minutes, excessive heat buildup may damage the paddles, rollers, and housing. Ensure that the liquid inlet is completely immersed.

### 3.1 Initial Operation

Turn the sampler on by pressing the Standby key. It is labeled with this icon: . The start-up screen appears first.











6712 SAMPLER  
STANDARD PROGRAMMING  
For HELP at any  
screen press ? key.

It remains on the display for about eight seconds or until you press a key. It tells you the type of programming screens the sampler is currently using — standard or extended — and gives you a tip about the on-line help. The main menu screen, shown below, appears next.

RUN  
PROGRAM  
VIEW REPORT  
OTHER FUNCTIONS

(If a module is attached, a different screen may appear first. See the module manual for more information.)

**Table 3-1 About the Keypad**

Key	Name	Function
	Standby	Turns sampler on or off.
	Stop	Stops the pump or distributor. Pauses a running sampling program. In programming screens, returns to a previous screen.
	Enter	Accepts a menu choice or number entry and goes to next screen.
	Help	In programming screens, displays a brief help message.
	Down-Right Arrow	Selects the menu option right or below the current choice.
	Up-Left Arrow	Selects the menu option left or above the current choice.
	Numbers	Types a number.
	Decimal Point	Types a decimal point.
	Pump Reverse	Press when at the main menu to run the pump in reverse.
	Pump Forward	Press when at the main menu to run the pump forward.

The sampler is programmed at the factory so that the standard programming screens appear when you first turn the sampler on. You can switch between programming modes by typing in a numerical command at the main menu:

- At the main menu type **6712.2** to show the extended programming screens.
- At the main menu type **6712.1** to show the standard programming screens.

The sampler will continue to use the program mode you selected, even if the sampler is turned off and on again, until you manually switch to the other programming mode.

With the display backlight activated, the screen will glow for several seconds following your last keystroke.

If you press a key and the screen text does not change, it is probably because the keystroke turned the backlight on, instead of performing its function. Press the same key again.

### 3.1.1 Selecting a Language

You have the option of having screens display in English or another language. The default is English. At the main menu, type **6712.8**:

ENGLISH SPANISH
--------------------

Use the arrow keys to move between the choices (languages other than those shown above could appear on your unit). When the language choice you want is blinking, press ↵(Enter). The ↵ (Enter) key always accepts the blinking option.

## 3.2 Using Menus and Entering Numbers

### The Main Menu

RUN PROGRAM VIEW REPORT OTHER FUNCTIONS
--

A menu is a list of options. The main menu has four options:

- RUN
- PROGRAM
- VIEW REPORT
- OTHER FUNCTIONS

The options identify the operations that can be performed from the menu. For example, to run the sampling program, select RUN; to modify the program, select PROGRAM.

### 3.2.1 Selecting Menu Options

In menu screens, one menu option always blinks.

- Press ↵ when the blinking option is the one you want; it will accept your choice and go to the next screen.
- Select a different option by pressing an arrow key until the option you want blinks. Then press ↵.

### 3.2.2 Entering Numbers

Number-entry screens prompt you to enter a value. An example is shown to the left.

SUCTION LINE LENGTH  
IS     ft  
(3-99)

- Type the length of the suction line. Acceptable values are shown between the parentheses. Press ↵ to accept the number.

To enter a number:

Press the number keys to type the number. Then, press ↵. As soon as you press ↵, the sampler saves your number and moves to the next screen. In some screens, you can use the . (Decimal Point) key in a number.

Some screens display the range of acceptable numbers between parentheses. If an entry is too low or high, the controller beeps and erases the entry. Type a new number and continue.

### 3.3 Quick View Screens

Quick View screens are a special type of menu screen. They show the current program settings and let you move quickly through the program. You must change the programming style to QUICK VIEW/CHANGE to see the quick view screens, as shown below:

- |   |   |                           |
|---|---|---------------------------|
| 1 | RUN<br>PROGRAM<br>VIEW REPORT<br><b>OTHER FUNCTIONS</b>     | Select OTHER FUNCTIONS.   |
| 2 | MAINTENANCE<br>MANUAL FUNCTIONS<br><b>PROGRAMMING STYLE</b> | Select PROGRAMMING STYLE. |
| 3 | PROGRAMMING STYLE<br>NORMAL<br><b>QUICK VIEW/CHANGE</b>     | Select QUICK VIEW/CHANGE. |

#### 3.3.1 Paging Through Quick View Screens

The arrows in the corners of each quick view screen are menu options that let you move from one quick view screen to another.

Select the up arrow (↑) to go to the previous screen.

Select the down arrow (↓) to go to the next screen.

Press Stop to return to the main menu.

Because the forward arrow is always blinking when the screen appears, you can simply press ↵ to go to the next quick view screen, making it easy to page through the screens.

#### 3.3.2 Changing Settings in a Quick View Screen

Although the quick view screens offer you a quick way to see the program settings, they also provide you with a way to change settings. Using quick view screens to change settings is sometimes a faster way to change a program because you can go quickly to the setting or settings that needs updating.

To change the program settings in a quick view screen:

Press an arrow until the setting blinks. Press ↵. The 6712 then displays the screen used to change the setting.

The following Quick View screens show you how to change the sample volume. Begin by paging through the quick view screens until you see the screen containing the sample volume setting:



- To see the Quick View screens, select PROGRAM.

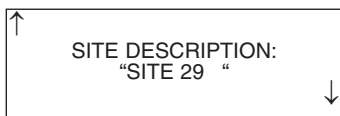

- Use the keypad's arrow key to select ↓ for the next quick view screen. When ↓ is blinking, press ↵.
- Use the keypad's arrow key to select ↑ for the previous quick view screen. When ↑ is blinking, press ↵.
- Use the keypad's arrow key to select the program setting. When the setting is blinking, press ↵ to display the screen used to change the setting.
- Press Stop for the main menu.
- All quick view screens work the same way.



- Press the arrow key until 200 ml SAMPLES blinks. Then press ↵.

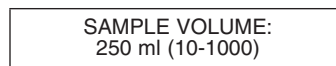

- Type the new sample volume and press ↵.

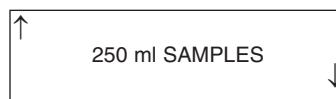

When you change a setting, the sampler stores the new settings and returns to the updated quick view screen. You can repeat this process until all settings shown in the quick view screens have been changed. When you are done, select the screen's forward arrow to move to the next quick view screen, or press Stop to return to the main menu.

### 3.4 Clock and Calendar

You may have to set the internal clock or calendar. The samplers are shipped with their clocks set to U.S. Central Standard time. If your sampler operates in a different time zone, you will have to reset the clock. The example below shows you how to find the time and date screen.

### Entering Times and Dates

ENTER TIME AND DATE: HH:MM DD-MON-YY _: _ - _ - _ -
---

- Move from one field to another by pressing the arrow keys.
- Change a setting in a field by typing a number. Press ↵ to accept the new setting.

When setting the clock and calendar, use a 24-hour clock for times and the day-month-year format for dates. The illustration at the left shows blanks for each position that accepts an entry. The positions are called fields. When this screen appears on your sampler, the fields will contain the sampler's current settings for the time and date.

- To move from one field to another without changing the setting, press the arrow keys. Use this technique when you want to change only one or two settings.
- Change the setting by typing a new number. Press ↵ to accept the new setting.

For example, to enter 2:00 p.m. (2:00 p.m. is 14:00 on a 24-hour clock), type 14. Press ↵. Next, type 0 (zero) for the minutes, and press ↵. To enter a date, such as January 22, 2001, type: 22 ↵ 01 ↵ 01 ↵.

#### 3.4.1 Setting the Clock and Calendar

1	RUN PROGRAM VIEW REPORT <b>OTHER FUNCTIONS</b>	Select OTHER FUNCTIONS.
2	<b>MAINTENANCE</b> MANUAL FUNCTIONS PROGRAMMING STYLE	Select MAINTENANCE.
3	<b>SET CLOCK</b> PUMP TUBE ALARM INTERNAL BATTERY DIAGNOSTICS	Select SET CLOCK.
4	ENTER TIME AND DATE: HH:MM DD-MON-YY 14:00 22-JAN-01	Enter the time and date.
5	SET CLOCK PUMP TUBE ALARM INTERNAL BATTERY DIAGNOSTICS	Press Stop to return to the main menu.

#### 3.4.2 Menu Screens: Clock Start Times

There are four start time settings you can use in a sampling program. This section discusses only one of these settings, the clock start time. A clock start time lets you set up a sampling program that starts at the same time on one or more days of the week. For example, you may want to begin sampling at 6:00 a.m. on Monday through Friday (refer to the screen below).

To select a day or days from the menu:

1. Press an arrow key until the cursor is on the correct day. Then, press ↵.
2. Repeat these steps until each day you want is blinking.
3. Press an arrow until DONE blinks. Press ↵.

To remove days from the list:

1. Press an arrow key until the cursor is on the day you want to remove. Press ↵ to deselect it.
2. When finished, select DONE and press ↵

```
NO DELAY TO START
DELAYED START
CLOCK TIME
WAIT FOR PHONE CALL
```

### Using the Clock Start Time Menu

- Select CLOCK TIME.

```
FIRST SAMPLE AT:
06:00
```

- Type the time of day and press ↵.

```
SELECT DAYS:
SU MO TU WE TH FR SA
DONE
```

- Press an arrow key until the cursor is on the correct day. Then, press ↵. To remove a day, move the cursor to it and press ↵ to deselect it.
- Repeat these steps until each day you want is blinking.
- Press an arrow until DONE blinks. Press ↵.

## 3.5 Menu Screens: Site Descriptions and Program Names

The sampler has two text-entry menus, one for site description and another for an extended-program name. They work in the same way. A site description is commonly a number, address, or other short note that helps identify the monitoring site. Extended programming has a similar screen that lets you enter program names for stored programs.

The example on the next page shows how to change the site description from FACTORY01 to SITE 29. Line 1 contains text between two quotation marks. Lines 2 and 3 contain the menu options — numbers, letters, and punctuation marks — used to spell out the description. In line 3, the space between the ampersand (&) and the double quotes (") is a space character. Line 4 contains two additional options:

- BACK-UP, an option that moves the cursor on the text line to the left one character.
- DONE, an option that tells the sampler to save the text.

### Changing the Site Name

```
SITE: "FACTORY01"  
ABCDEFGHIJKLMNOPQRST  
UVWXYZ-& "0123456789  
BACK-UP  DONE
```

```
SITE: "SACTORY01"  
ABCDEFGHIJKLMNOPQRST  
UVWXYZ-& "0123456789  
BACK-UP  DONE
```

- Press the Down-Right arrow until the **S** on line 2 blinks. Then, press ↵.

```
SITE: "SICTORY051"  
ABCDEFGHIJKLMNOPQRST  
UVWXYZ-& "0123456789  
BACK-UP  DONE
```

- Press the Up-Left arrow until the **I** blinks. Press ↵.
- Continue pressing arrow keys to select **T**, **E**, and space. Press ↵ after selecting each character.

```
SITE: "SITE_29_ "  
ABCDEFGHIJKLMNÖPQRST  
UVWXYZ-& "0123456789  
BACK-UP  DONE
```

- Press 29 on the keypad, then Up-Left until space blinks. Press ↵.

```
SITE: "SITE_29_ "  
ABCDEFGHIJKLMNÖPQRST  
UVWXYZ-& "0123456789  
BACK-UP  DONE
```

- Press the Down-Right arrow until **DONE** blinks. Press ↵.

The cursor is the blinking rectangle that identifies the current field. When the screen first appears, the cursor blinks on the first character of the text in line 1. The matching character in line 2 or 3 also blinks.

When you press ↵, the cursor on line 1 moves to the right one position, and, at the same time, the sampler blinks on the matching character on lines 2 or 3.

To change any character in the text line:

1. Press the left or right arrow until the replacement character on lines 2 or 3 blinks.
2. Press ↵. The replacement character will appear on the first line, and the cursor will move to the next character.

*Repeat steps 1 and 2 until the text in the top line is complete.*

3. Finish the entry by selecting **DONE**. Then, press ↵.

Some additional tips for using the text-entry menus:

- Hold an arrow key down for faster movement.
- If your description uses all ten spaces in the text line, the sampler automatically moves to the next screen as soon as you add the tenth character.
- You can enter numbers by pressing the number keys.
- Erase characters by replacing them with a space character.
- Select the **BACK-UP** option to move the cursor to the left.
- To leave the menu before completing the entry, press **Stop**. The sampler will display this menu:

```
SAVE CHANGES?  
YES  NO
```

Select **YES** to save any changes made. Select **NO** to leave the original description (or program name) unchanged.

### 3.6 Messages

The sampler has four sets of messages that supplement the programming screens. **Information messages** tell you about programming status. **Help Notes** are brief comments associated with programming screens describing the setting or offering assistance. **Warning messages** tell you something is different from Isco's standard. **Operation messages** report the sampler's status as it runs a program.



### 3.6.1 Information Messages

These are brief messages about the programming status, such as “ROM’ PASSED TEST” or the status message that displays when you first start up the sampler. Information messages are displayed for four seconds, unless they are terminated by pressing any key on the keypad.

### 3.6.2 Help Notes

To see a Help note:

1. Press the ? (Help) key.
2. When the note requires several screens, the word “more” appears in the lower-right corner. Press ↵ for the next note.
3. Move back and forth between screens by pressing the arrow keys.
4. Press Stop at any time to return to the programming screen.

Most help notes refer to a related section in this manual. Screens that require extensive explanation have notes that contain only a reference to the manual. Sections mentioned in the notes appear in the index and the table of contents.

SUCTION LINE LENGTH  
IS 7 ft  
(3-99)

- Press ? (Help).

Enter the length of suction line only, excluding strainer and pump tube. <more>

- Press ↵ or Down-Right to see the next screen.
- Press Stop to return to the programming screen.

See “Installing Suction Line” in your manual. <more>

- Press ↵ or Down-Right to see the next screen.
- Press Up-Left to see the previous screen.
- Press Stop to return to the programming screen.

Press the red STOP key to exit HELP.

- Press Up-Right to see the previous notes.
- Press Stop to return to the programming screen.

### Using Help Notes

Although this example shows the Help Notes that are associated with the suction line length screen, you can use the same technique to see help notes for other screens.

### 3.6.3 Warning Messages

Warning messages appear when the sampler determines something is out of the ordinary. For example, the following warning appears when you type a number that is larger than the standard bottle volume:

```
BOTTLE VOLUME IS
3500 ml (300-30000)
```

```
WARNING!
STANDARD BOTTLE
VOLUME EXCEEDED!
```

The 6712 does accept nonstandard volumes because you might use a nonstandard container occasionally. For a list of recommended volumes for Isco bottles press the ? (Help) key at the “Bottle Volume Is” screen, or refer to the Technical Specifications.

The 6712 uses the bottle and sample-volume settings to determine the maximum number of samples that can be deposited without overflowing the bottles. Entering a volume that exceeds the standard volume may cause the sampler to overflow the bottle.

### 3.6.4 Operation Messages

An operation message reports the sampler’s status as it runs a program. An example is shown below.

```
PROGRAM WILL START
AT 06:00 TU 20-FEB
05:56:22 TU 20-FEB
```

## 3.7 Menu Trees

Selecting a menu option will take you to a number-entry screen or another menu screen. The screens are organized in a branching structure that resembles a tree. Refer to Figure 3-1 for a simple chart of the menu tree for standard programming. The standard programming structure is different — much simpler — than the extended programming structure. Charts that show you most of the sampler’s screens appear in *Appendix A, Flowcharts*.

The entire structure changes a little when a module is attached because the sampler adds a set of screens for a module as soon as it detects the module’s presence. The manuals for each module contain menu trees for its programming screens.

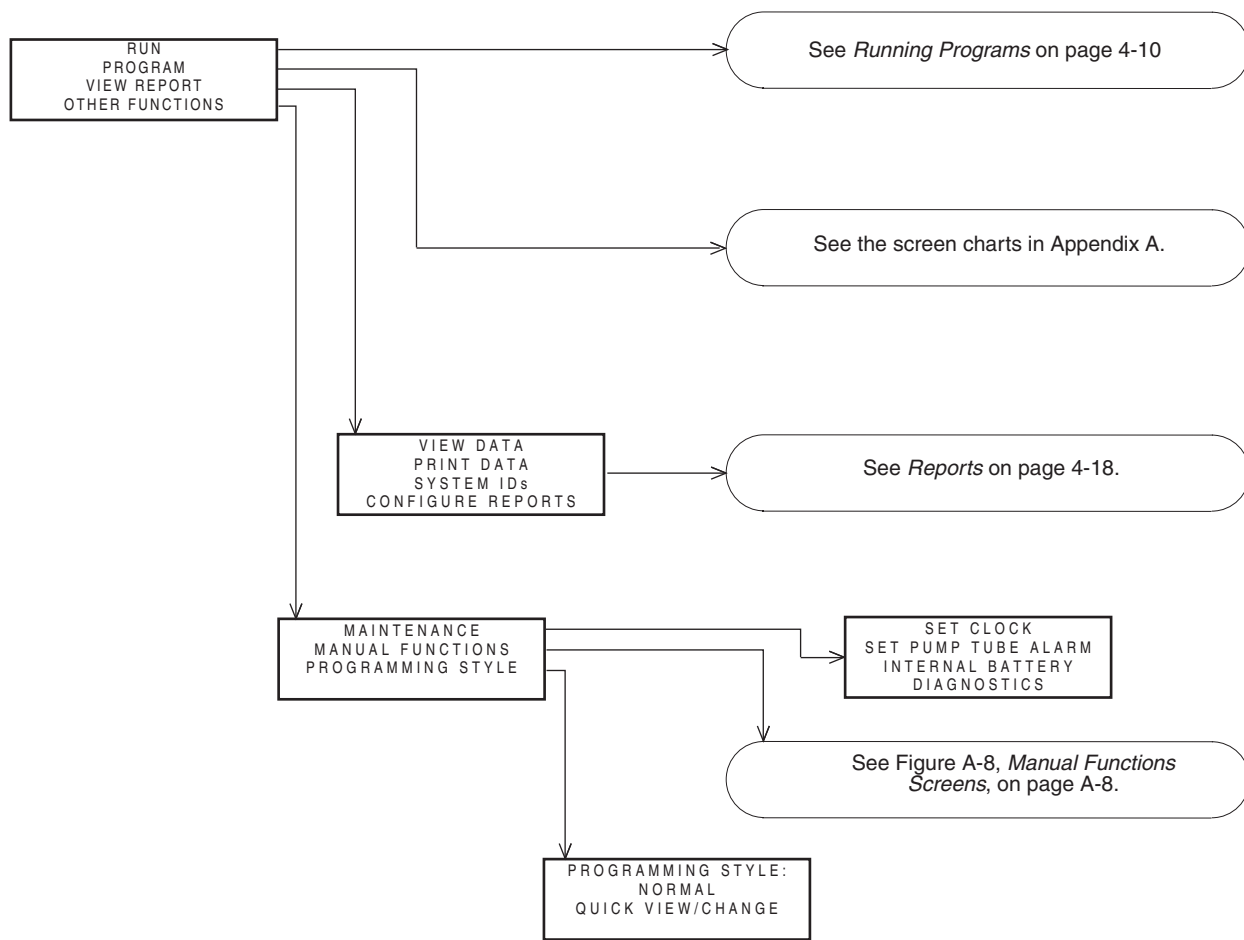

Figure 3-1 Menu Tree for Standard Programming



# 6712FR Refrigerated Sampler

## Section 4 Standard Programming

The 6712FR Sampler has two sets of programming screens. The first set, called standard programming screens, lets you set up typical sampling programs easily and efficiently. The second set, extended programming screens, lets you create sophisticated programs for complex sampling applications.

All of the sampling features available within the standard programming screens are available in extended programming. However, extended programming provides several additional features which are discussed in the next section. Menu flowcharts for both sets of programming screens are in Appendix A.

### 4.1 Switching Between Standard and Extended Modes

Factory default settings cause the sampler to begin in standard programming mode the first time you turn it on. The start-up screen tells you which programming mode the sampler is currently using. You can switch between programming modes by entering a numerical command at the main menu:

- At the main menu, type **6712.1** to enter standard programming mode.
- At the main menu, type **6712.2** to enter extended programming mode.

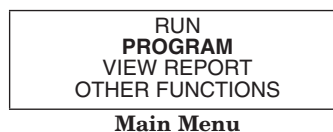

RUN  
PROGRAM  
VIEW REPORT  
OTHER FUNCTIONS

**Main Menu**

### 4.2 Language Selection, Units of Length

You have the option of displaying screens in English or Spanish (or possibly another language). The default is English. At the main menu, type **6712.8** to display:



ENGLISH  
SPANISH

Use the arrow key to move between the two choices. When the desired choice is blinking, press ↵.

If you select the English option, you will advance to a second screen that asks you to select your units of length:

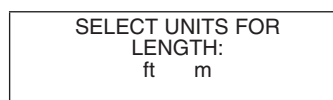

SELECT UNITS FOR  
LENGTH:  
ft m

Use the arrow key to move between the two choices, feet or meters. When the desired choice is blinking, press ↵. The default unit of length for the Spanish option is meters.

### 4.3 Programming Examples

The following table is an example of time-paced sampling. Further details about some of the menu items are provided in later sections.

**Table 4-1 Standard Program: Sample Every 15 Minutes, One Sample Per Bottle**

1	6712 SAMPLER STANDARD PROGRAMMING For HELP at any screen press ? key.	Turn the sampler on by pressing the On/Off key. Press ↵.  This screen disappears on its own after 8 seconds.
2	RUN <b>PROGRAM</b> VIEW REPORT OTHER FUNCTIONS	The option PROGRAM will be blinking. Press ↵.
3	SITE DESCRIPTION: "FACTORY051" CHANGE? YES NO	The option NO will be blinking. Press ↵. For the purposes of this example, it isn't necessary to change the description.
4	NUMBER OF BOTTLES: 1 2 4 8 12 <b>24</b>	Select the number of bottles in your bottle kit by pressing either arrow key until the correct number blinks. Press ↵. For this example, select 24.
5	BOTTLE VOLUME IS 1000 ml (300-30000)	Type the volume for the bottles in your kit. For this example, 1000 is correct, so simply press ↵.
6	SUCTION LINE LENGTH IS 10 ft (3-99)	Type the length of the suction line, then press ↵. If you change the length, the sampler will display a message, "PLEASE WAIT!. . . GENERATING PUMP TABLES."
7	<b>TIME PACED</b> FLOW PACED	Because this example requires samples every 15 minutes, select TIME PACED by pressing an arrow until the option TIME PACED blinks. Then, press ↵.
8	TIME BETWEEN SAMPLE EVENTS 0 HOURS, 15 MINUTES	Type 0 for hours and press ↵. Type 15 for minutes and press ↵. Tip: Move back and forth between hours and minutes by pressing an arrow key.
9	<b>SEQUENTIAL</b> BOTTLES/SAMPLE SAMPLES/BOTTLE	Because this program requires one sample in each bottle, select SEQUENTIAL by pressing an arrow until the option SEQUENTIAL blinks. Then, press ↵.
10	RUN CONTINUOUSLY? YES NO	For this example, select NO by pressing an arrow until the option blinks. Then, press ↵. Selecting YES allows the program to run indefinitely by repeating the sample distribution. Continuous sampling assumes that filled bottles are replaced with empty bottles at regular service intervals.

**Table 4-1 Standard Program: Sample Every 15 Minutes, One Sample Per Bottle**

11	SAMPLE VOLUME: 200 ml (10-1000)	Type the volume of the sample you want deposited in each bottle. Then, press ↵.
12	NO DELAY TO START <b>DELAYED START</b> CLOCK TIME WAIT FOR PHONE CALL	For this example, select DELAYED START by pressing an arrow until the option blinks. Then, press ↵.
13	FIRST SAMPLE AFTER A 5 MINUTE DELAY (1-999)	Type the delay period you want between the time you run the program and the time the sampler takes the first sample. Then, press ↵.
14	PROGRAMMING COMPLETE RUN THIS PROGRAM NOW? YES <b>NO</b>	Run the program immediately by selecting YES. Select NO if you want to run the program later by selecting RUN from the main menu. Press ↵ after making your choice. In this example, NO is selected.
15	<b>RUN</b> PROGRAM VIEW REPORT OTHER FUNCTIONS	Run the program by selecting RUN and pressing ↵.

The following table is an example of flow-paced sampling.

- Program type: Standard
- Site description: SITE 29
- Bottle kit: 24, 1000 milliliter bottles
- Suction line length: 7 feet
- Pacing: Flow pacing, every two pulses
- Distribution: 2 bottles per sample
- Sample Volume: 250 milliliters
- Start time: Clock Time, 6:00 a.m. on Monday, Wednesday, Friday
- Module: No module installed

**Table 4-2 Standard Program: Flow-Paced Sampling, Two Bottles Per Sample**

1	6712 SAMPLER STANDARD PROGRAMMING For HELP at any screen press ? key.	
2	<b>RUN</b> <b>PROGRAM</b> VIEW REPORT OTHER FUNCTIONS	Select PROGRAM.
3	SITE DESCRIPTION: "FACTORY051" CHANGE? YES <b>NO</b>	Select NO.

**Table 4-2 Standard Program: Flow-Paced Sampling, Two Bottles Per Sample (Con-**

4	NUMBER OF BOTTLES: 1 2 4 8 12 <b>24</b>	Select 24.
5	BOTTLE VOLUME IS 1000 ml (300-30000)	Enter 1000.
6	SUCTION LINE LENGTH IS 10 ft (3-99)	Enter 7.
7	TIME PACED <b>FLOW PACED</b>	Select FLOW PACED.
8	FLOW BETWEEN SAMPLE EVENTS: 2 PULSES (1-9999)	Enter the number of pulses between sample events.
9	SEQUENTIAL <b>BOTTLES/SAMPLE</b> SAMPLES/BOTTLE	Select BOTTLES/SAMPLE.
10	RUN CONTINUOUSLY? YES <b>NO</b>	For this example, select NO by pressing an arrow until the option blinks. Then, press ↵. Selecting YES allows the program to run indefinitely by repeating the sample distribution. Continuous sampling assumes that filled bottles are replaced with empty bottles at regular service intervals.
11	1 BOTTLES PER SAMPLE EVENT (1-24)	Enter 2.
12	NO DELAY TO START DELAYED START <b>CLOCK TIME</b> WAIT FOR PHONE CALL	Select CLOCK TIME.
13	START FLOW COUNT AT: 00:00	Enter 6, then enter 0. This is the time at which the sampler will start the pacing countdown.
14	SELECT DAYS: SU <b>MO</b> TU WE TH FR SA DONE	Select MO, WE, and FR. Use the arrow keys and ↵ to select the days. When the correct days are blinking, select DONE and press ↵.
15	PROGRAMMING COMPLETE RUN THIS PROGRAM NOW? YES <b>NO</b>	Select NO.



## 4.4 Pacing

### Standard Time Pacing and Flow Pacing Screens for Samplers without Flow Modules

```
TIME PACED  
FLOW PACED
```

- When programming, you will be asked to select time or flow paced sampling. Depending upon your choice, you will see one of the following screens:

```
TIME BETWEEN  
SAMPLE EVENTS:  
__ HOURS, __ MINUTES
```

```
FLOW BETWEEN  
SAMPLE EVENTS:  
____ PULSES (1-9999)
```

### Flow Pacing Screen for Samplers with Flow Modules

```
FLOW BETWEEN  
SAMPLE EVENTS:  
____ Mgal  
(0.001 -99999)
```

Sample pacing is the rate at which the sampler takes samples. Depending on the type of pacing you select, the rate is controlled by the sampler's internal clock or by inputs received from connected instruments.

Standard programming provides time pacing and flow pacing (refer to Step 7 in the previous two programming examples). In time-paced sampling, the interval between samples is a constant time interval. When you program the sampler for time pacing, the sampler prompts you to enter the time between sample events in hours and minutes. Time paced programs always take a sample at the start time.

Flow paced sampling requires a flow meter, flow logger, or a module. A flow meter or flow logger paces a sampler by sending an electronic signal to the sampler after measuring a specified volume of liquid. Because each pulse represents a volume interval, flow pacing rates are proportional to the volume of water flowing through the channel.

When you program the sampler for flow pacing and are using a flow meter or flow logger, the sampler prompts you to enter the interval between sample events in pulses. The sampler initiates a sample event when the set number of pulses is received. Programs that are flow paced do not take a sample at the start time.

After setting the program start time, you will be prompted to enter a maximum run time of zero to 999 hours. If you would like the program to run indefinitely, enter 0 (zero) for maximum run time.

The flow pacing screens change when you attach a flow module (see example to the left). Because the sampler is more closely integrated with the modules, the standard flow pacing screen prompts you for the flow volume between sample events instead of pulses between events. The flow volume units displayed are what you had previously programmed.

### 4.4.1 Trigger Pacing

Isco 4200 Series Flow Meters and 4100 Series Flow Loggers send pulses for trigger pacing. The flow meter or flow logger sends pulses at two different time intervals when trigger pacing a sampler. Trigger pacing, for example, lets you sample less frequently when the trigger condition — a condition based on level, flow, or rainfall — remains below a set point. The intervals are determined by the flow instrument's program settings for trigger pacing.

When conditions change and readings pass the set point, triggering the new rate, you can sample more frequently. Or, when the trigger condition is a clock setting, the instrument changes the pacing interval according to the time of day. Using a clock trigger condition, for instance, the flow meter or flow logger can pace the sampler slowly at night and more frequently during the day. (For more information about trigger pacing, see your flow meter or FLOWLINK manual.)

The flow meter or flow logger sends the same pulse for both flow and trigger pacing, and the sampler cannot distinguish between them. Therefore, to program a sampler for trigger pacing, simply program it for flow pacing.

## 4.5 Distribution

Distribution describes how the sampler is to deposit samples. A sample is the volume of liquid deposited in a bottle. A sample event includes the full sampling cycle and may deposit a sample into more than one bottle.

In standard programming, you can program the sampler for these different distribution methods:

- Sequential
- Bottles Per Sample
- Samples Per Bottle
- Composite

### 4.5.1 Sequential

In sequential distribution, the sampler deposits one sample in each bottle. A sequential sample represents a “snapshot” of the flow stream at a point in time.

### 4.5.2 Bottles Per Sample

In bottles per sample distribution, the sampler deposits a sample in each of a set of bottles. A bottle set includes at least two bottles but may include all bottles. Use bottles per sample when the volume to be collected is larger than the amount one bottle can hold or when you need identical samples.

### 4.5.3 Samples Per Bottle

In samples per bottle distribution, the sampler deposits samples from several sample events in a single bottle before moving to the next bottle. Use samples per bottle distribution to collect a series of small composite samples.

### 4.5.4 Composite

For single bottle configurations, samples per bottle distribution is known as composite sampling. A composite sample represents an average of the flow stream’s characteristics during the sampling period.

### 4.5.5 Continuous Sampling

Sample programs can be run indefinitely by selecting “YES” at the “RUN CONTINUOUSLY?” screen. Continuous sampling resets the distribution when the distribution sequence is complete. That is, when the last bottle/set is reached, the next bottle/set is the first bottle/set. All pacing modes except RANDOM are supported.

When running a program continuously, the bottles must be serviced at regular intervals to prevent overfilling the bottles. The sampler assumes that the next bottle/set is empty and ready to receive samples.

The figure on the next page steps through the programming screens for sequential, bottles per sample, and samples per bottle distribution.

**Sequential**

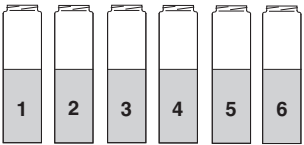

Each bottle receives one sample from one sample event.

**Bottles-per-Sample**

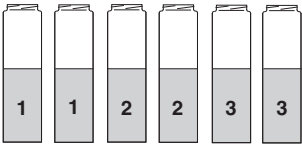

Multiple bottles receive a sample from one sample event.

**Samples-per-Bottle**

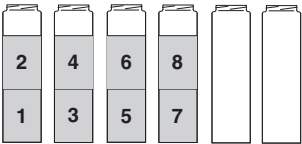

Each bottle receives a sample from multiple sample events.

Figure 4-1 Sample Distribution

## 4.6 Start Times

It is important to understand the difference between the time at which you run a program and the program's start time. Running a program simply means selecting RUN from the sampler's main menu. The start time is the time at which the sampler begins the program's first sample interval countdown. The start time is controlled by your selections from the start time screens.

Each program contains start-time settings that tell the sampler when to begin the program. When programming the sampler, you can select one of four start time options: NO DELAY TO START, DELAYED START, CLOCK TIME, or WAIT FOR PHONE CALL.

- Select NO DELAY TO START when you want the sampler to start as soon as you select RUN.
- Select DELAYED START when you want the sampler to delay from 1 to 999 minutes before starting the program.
- Select CLOCK TIME when you want the sampler to begin the program at a specific time on at least one day of the week.
- Select WAIT FOR PHONE CALL when you want the sampler to begin the program after receiving a remote command to start.

### 4.6.1 How Do Start Times Work?

As soon as you select RUN from the main menu, the sampler checks the program's start time settings. With a "DELAYED START" setting, the sampler starts a countdown to the start time. The period between the time you select RUN and the start time you've specified in the program is called the "delay to start time."

When you run a program with "CLOCK TIME" settings, the sampler also starts a countdown to start time until the day of week and clock times are met.

The sampler may not collect a sample at the start time. The sampler must be enabled, and the pacing selected must call for a sample at start. In any event, the sampler checks the pacing settings and begins the pacing-interval countdown.

### Delayed Start Screen

1 NO DELAY TO START  
**DELAYED START**  
CLOCK TIME  
WAIT FOR PHONE CALL

- Select DELAYED START.

2 FIRST SAMPLE  
AFTER A  
\_\_ MINUTE DELAY  
(1-999)

- Enter the number of minutes to delay the countdown to the first sample.

3 START FLOW COUNT  
AFTER A  
\_\_ MINUTE DELAY  
(1-999)

- The sampler uses this screen for flow paced programs.

### Clock Start Time Menu

1 NO DELAY TO START  
DELAYED START  
**CLOCK TIME**  
WAIT FOR PHONE CALL

- Select CLOCK TIME.

2 FIRST SAMPLE AT  
06:00

- Enter the time of day.

3 SELECT DAYS:  
SU MO TU WE TH FR SA  
DONE

- Press an arrow key until the cursor is on the correct day. Press ↵.
- Repeat until each day you want is blinking.
- Press an arrow until DONE blinks. Press ↵.

#### 4.6.2 Sampler Enable/Disable

Isco flow meters and flow loggers have a programmable sampler-enable feature that lets them enable (start) or disable (stop) a program according to certain monitored conditions. For example these conditions can be level, flow rate, pH, temperature, percent, rainfall, I/O; or a combination of two conditions.

The Model 1640 Liquid Level Actuator can also be used, as well as any other instrument that can ground the input to pin F. Grounding the input disables the sampler.

The sampler disregards disable signals during the delay to start time. However, when the sampler detects a disable signal at the start time, it suspends the program until it is enabled. The diagram in Figure 4-2 shows the sampler's responses.

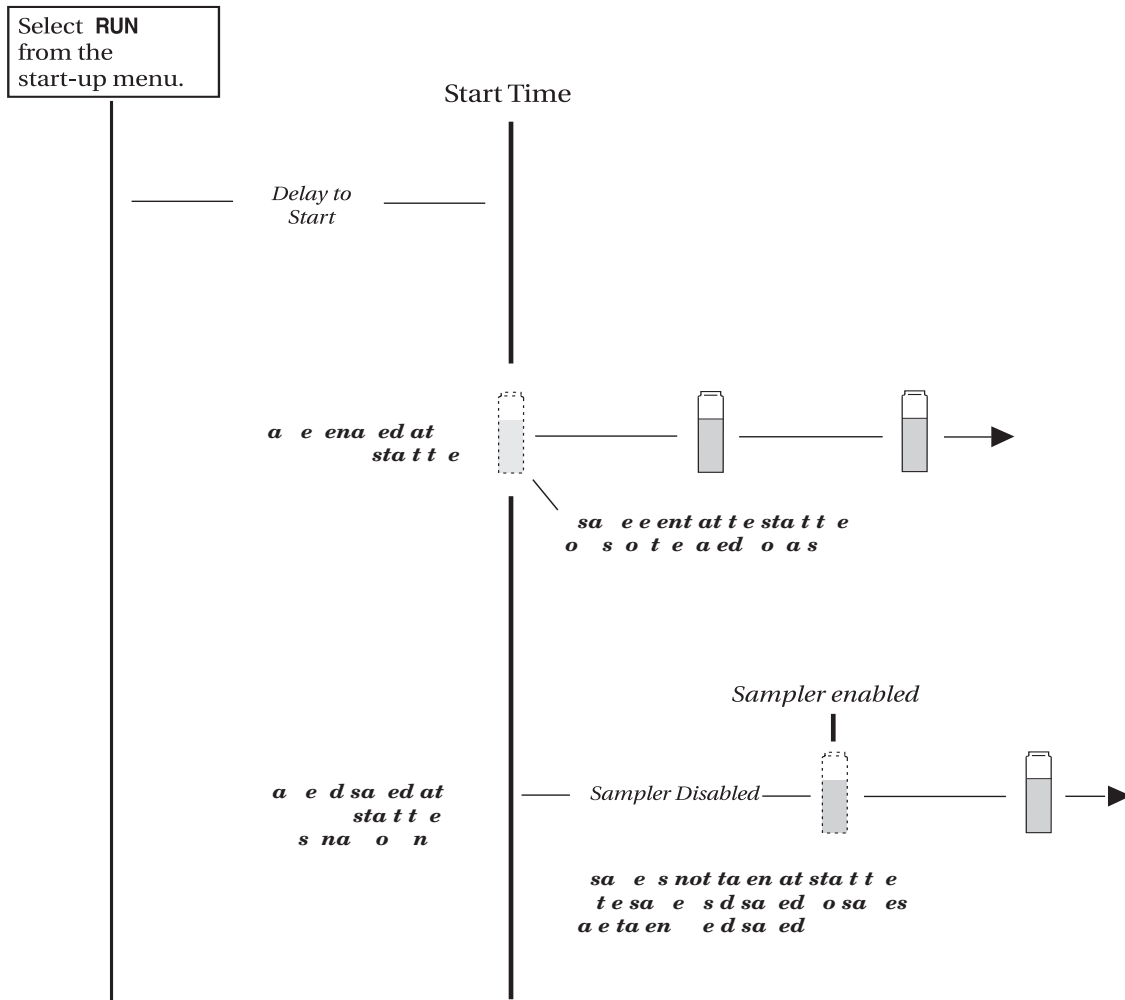

Figure 4-2 Start Time Diagram

## 4.7 Running Programs

To run a program, select RUN from the main menu. You may also select YES at the RUN THIS PROGRAM NOW? screen at the end of the programming screens.

### 4.7.1 Run Time Screens

While running a sampling program the sampler displays a variety of messages that report the program's status. For example, if the sampler has not yet reached the programmed start time, it displays the scheduled start time as well as the current time.

Once the program reaches the start time, you can determine the time of the next sample, the next bottle to receive a sample, sample distribution, and other information. Other messages appear while the sampler runs through a sampling cycle and takes a sample. When the sampler needs to report multiple messages, it alternates them, displaying each for one to three seconds.

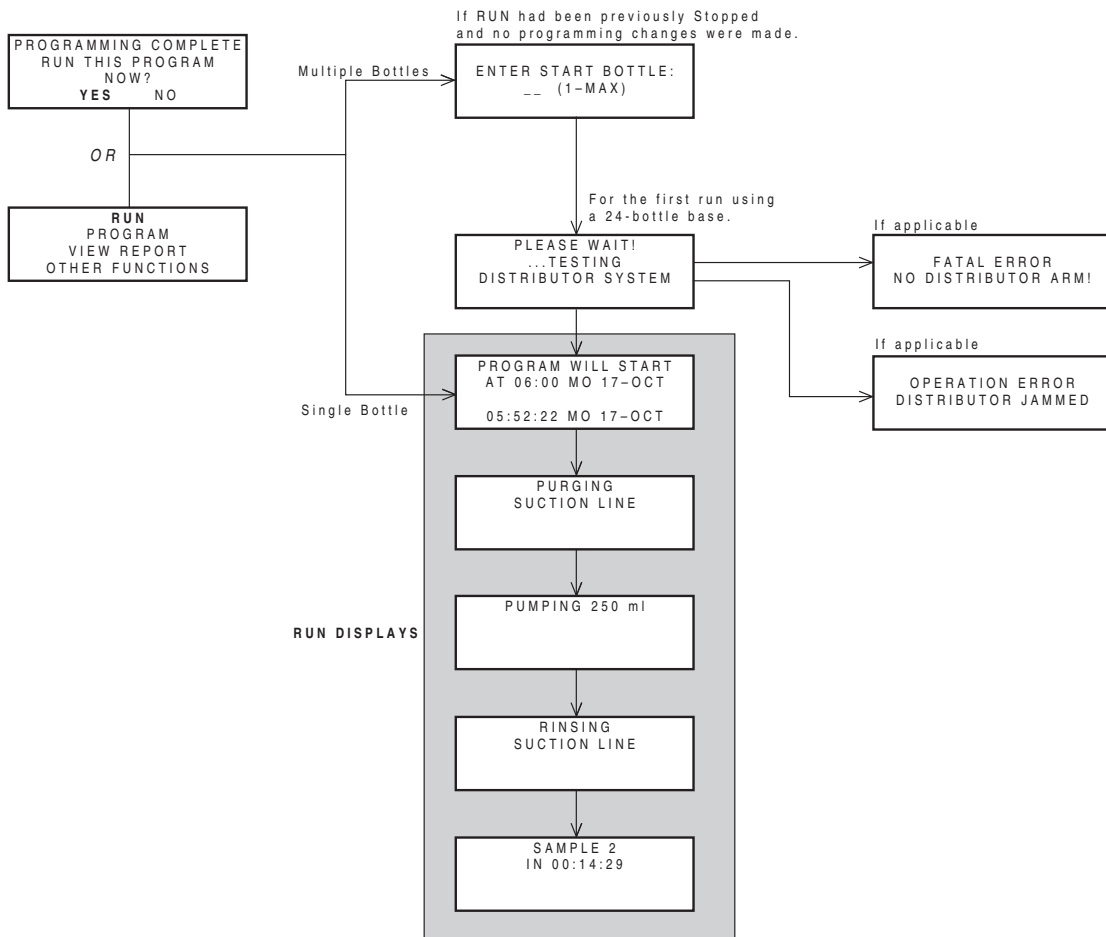

Figure 4-3 Running a Program

#### 4.7.2 Module Readings

Samplers with an attached module display the module's readings: pH and temperature for the pH module; level, percentage, or flow rate for the 4-20 mA module; level, flow rate, and flow volume readings for the flow modules; level, velocity, flow rate, and positive flow volume readings for the area velocity module. Some module screens will alternate with the sampler screens.

<p>BOTTLE 2 IN 00:14:39 150 gpm    0.82 ft 00001438200 gal</p>
--

The Module readings are updated:

- Every second when displaying the reading during programming.
- Every minute otherwise.

An asterisk (\*) appears next to the reading if the module was unable to take a reading. If an asterisk appears, the reading displayed is the last available reading. Flow rates will be reported as zero flow if the error persists for more than five minutes (for a level or velocity reading that flow is calculated from).

If an entire reading is filled with asterisks, the value exceeds the number of characters that can be displayed. The sampler stores the actual reading in memory, so it may be collected later.

```
BOTTLE 2
IN 00:12:00
***** gpm    5.73 ft
00001457600 gal
```

For those programs that have delayed or scheduled start times, the readings will be displayed while waiting for the start time. Keep in mind that any totalizer values will be reset at the start time. Module and sonde readings are also displayed after a program is complete, until a key is pressed.

It is not necessary to run a program to view module or sonde readings. Real time data can be viewed on the display by selecting "VIEW REPORT" from the main menu.

## 4.8 Interrupting a Running Program

You can interrupt a sampling program by pressing the Stop key while the sampler is waiting for the next sample event. Pressing Stop places the sampler into *Manual Paused* operation and records a manual pause in the sample event log.

In this state, the sampler allows you to access several functions. You can modify the program, reset alarms, take a grab sample, etc., without adversely affecting the running program. Modifying the program is limited to adjusting the pacing intervals, enable conditions and sample volume. The basic program structure, such as the type of pacing, can not be changed.

While in the manual paused state, the sampling program continues to operate as normal, with the exception of taking samples. If a sample was to be taken, it is skipped. The sampler records "sample skipped" in the sample event log and continues to operate as normal.

The manual paused state displays a scrolling menu with several options (see example below). Use the Arrow keys to scroll through the manual paused options and the ↵ key to make a selection. Return to the running program by selecting resume program or pressing the Stop key. If you do not make a selection, the sampler automatically resumes the original sampling program five minutes after the last key was pressed.

```
← STOP PROGRAM
RESUME PROGRAM
VIEW DATA
GRAB SAMPLE →
```

Manual Paused Screen

### 4.8.1 Stop Program

This option terminates the running program and records program stopped in the sample event log. The program cannot be resumed.

### 4.8.2 Resume Program

Selecting this option will cause the sampler to exit the manual paused state and return to normal program operation. A manual resume event will be logged.



- 4.8.3 View Data** This option allows you to view the data recorded by the sampler. See *Reports* on page 4-18 for more information.
- 4.8.4 Grab Sample** When selected, you will be asked to enter the volume to be pumped. A sample will then be taken as if it is to be *placed into a container outside the sampler*. Do this by removing the pump tubing from the bulkhead fitting. See *Grab Samples* on page 4-14. A grab sample event will be logged.
- 4.8.5 Pump Tube Alarm** If the pump tube is changed, this option should be selected to reset the pump counts on the counter. This will remove the “WARNING: REPLACE PUMP TUBING” message that may appear while the program is running. A pump tube replaced message is logged. See *Replacing The Pump Tube* in Section 7, *Maintenance*.
- 4.8.6 Calibrate Volume** When selected, you will be asked to enter the volume to be pumped. A sample will then be taken as if it is to be *placed into a container outside the sampler base*. Do this by removing the pump tubing from the bulkhead fitting.
- After the sample has been pumped, you will then be asked to enter the amount actually delivered. Once you have entered the delivered volume and accepted the calibration, a volume delivered event will be logged.
- 4.8.7 Cal/Adj Parameters** When the sampler is configured for operation with a module, this option becomes available. Selecting this option will display the appropriate level adjustment screens and/or the calibration screens. If the level is adjusted, an adjusted level event is logged. If a parameter is calibrated, an appropriate event is logged.
- Calibrating a parameter probe will temporarily “turn off” the partition data storage and the sample enable/disable functions. These functions are disabled during the calibration and for five minutes after the program is resumed. During this time, parameter data normally collected at the data storage interval will be logged as a 252 error message.
- 4.8.8 Adjust Pacing** This option is available when the running program is paced by Time, Flow Pulses or Flow Volume. If you select this option, you are asked to enter a new pacing interval. The sampler logs an interval changed event.
- The original pacing interval continues to count down until you return the sampler to the running program (select resume program). If the new pacing interval is less than the original count remaining, the new interval is used.
- If the original count remaining is less than the new pacing interval, the original count will continue to count down to the next sample event. Subsequent samples are then paced by the new interval.

#### 4.8.9 Adjust Volume

Select this option to change the sample volume within the limits of the currently programmed sample distribution. If you change a sample volume, a volume changed event is logged.

#### 4.8.10 Power Used

The 6712FR has a “fuel gauge” that gives an indication of power usage. The controller keeps track of how much power has been consumed since the last time it lost power. If the controller is powered by an external battery, this fuel gauge can help you estimate the condition of the battery.

Keep in mind that the sampler has no idea as to how much charge was originally stored in the battery (or even if a battery is being used), and therefore has no idea as to the *remaining capacity* of its power source.

### 4.9 Other Functions

#### Other Functions Menu

RUN PROGRAM VIEW REPORT OTHER FUNCTIONS
---

- Select OTHER FUNCTIONS.

MAINTENANCE MANUAL FUNCTIONS PROGRAMMING STYLE
--

In Standard Programming, the “Other Functions” menu screen includes options for:

- Maintenance (see Section 7).
- Manual Functions (see below).
- Programming Style (see Section 3).

#### 4.10 Manual Functions

The manual functions programming screens let you:

- Take grab samples.
- Calibrate sample volumes.
- Operate the pump manually.
- Move the distributor arm.

#### 4.11 Grab Samples

Grab samples let you take a single sample on demand, collecting the sample in an external container (Figure 4-4). Keep in mind:

When the sampler delivers a grab sample, it runs through a complete sampling cycle, using the current settings for volume and for line rinses or retries. If it is a two-part program, the sampler uses the settings for part A.

To take a grab sample while the sampler is running a program, you must interrupt the program by pressing the Stop key. Restart the program by running it again.

#### To take a grab sample:

1. Disconnect the pump tube from the bulkhead fitting.
2. Place the end of the tube over a collection container.
3. Follow the steps in *Taking a Grab Sample* at left.
4. Reconnect the pump tube to the bulkhead fitting.

### Taking a Grab Sample

1 GRAB SAMPLE  
CALIBRATE VOLUME  
OPERATE PUMP  
MOVE DISTRIBUTOR

- Select GRAB SAMPLE

2 SAMPLE VOLUME:  
\_\_\_ ml (10-9990)

- Enter the desired volume

3 GRAB SAMPLE  
PRESS ▾ WHEN READY!

4 PURGING  
SUCTION LINE

5 PUMPING 200 ml

6 PURGING  
SUCTION LINE

7 GRAB SAMPLE  
CALIBRATE VOLUME  
OPERATE PUMP  
MOVE DISTRIBUTOR

- Press STOP to return to main menu.

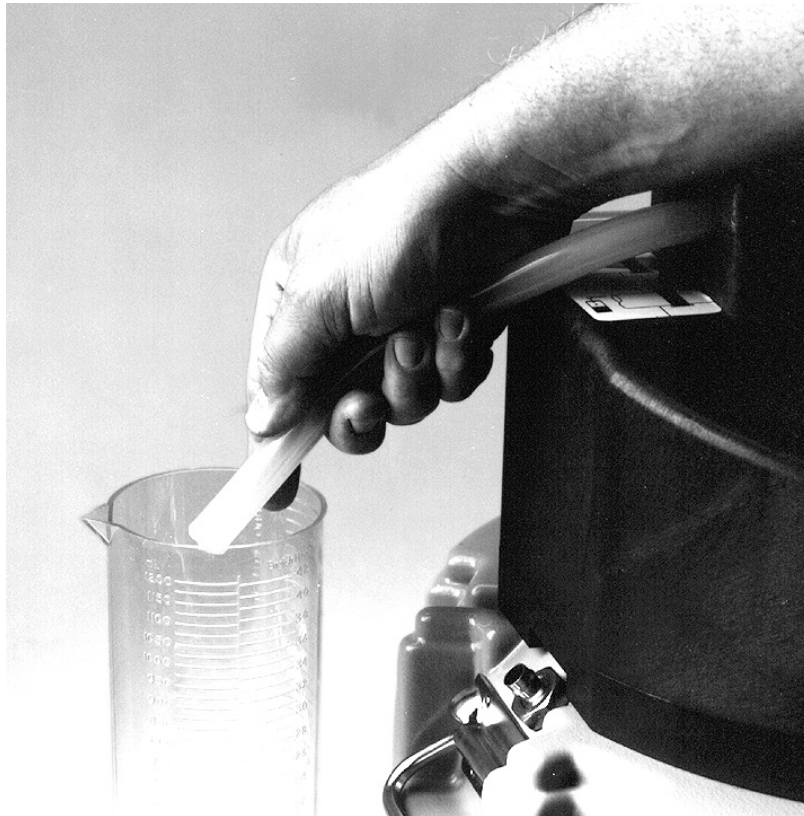

Figure 4-4 Taking a Grab Sample

## 4.12 Calibrate Volume

The sampler delivers accurate sample volumes without calibration. If you find that sample volumes vary significantly from the programmed values, first check the suction line for proper installation. Be sure it slopes continuously downhill to the liquid source and drains completely after each sampling cycle. Then, compare the actual length of the suction line to the suction line length settings in the program to see that they match. Also check the pump tube for excessive wear and replace it if necessary.

You may want to calibrate when:

- A new pump tube is installed. Run the pump for five minutes before calibrating.
- The sample source is above the sampler.
- Sampling from pressurized lines (15 PSI Maximum).

### 4.12.1 Calibration Tips

- For the best results, calibrate the sampler after it's installed on site.
- Use a graduated cylinder for volume measurement.
- The sampler clears the previous calibration setting when you reinitialize the sampler.
- You cannot calibrate while the sampler is running a program.
- When the sampler delivers the sample, it runs through a complete sampling cycle, using the current settings for volume line rinses and retries. If it is a two part program, the sampler uses the volume setting for part A.

### Calibrating Sample Volumes

1

RUN  
 PROGRAM  
 VIEW REPORT  
**OTHER FUNCTIONS**

- Select OTHER FUNCTIONS

2

MAINTENANCE  
**MANUAL FUNCTIONS**  
 MODULE  
 HARDWARE

- Select MANUAL FUNCTIONS

3

GRAB SAMPLE  
**CALIBRATE VOLUME**  
 OPERATE PUMP  
 MOVE DISTRIBUTOR

- Select CALIBRATE VOLUME

4

SAMPLE VOLUME:  
 \_\_\_ ml (100-9990)

- Enter the desired volume

5

CALIBRATE VOLUME  
 PRESS ↵ WHEN READY!

6

PURGING  
 SUCTION LINE

7

PUMPING 200 ml

8

PURGING  
 SUCTION LINE

9

VOLUME DELIVERED:  
 \_\_\_ml

- Measure the volume delivered and enter the amount here.

10

200 ml  
 ARE YOU SURE?  
 YES NO

This screen appears when the amount you entered in step 9 was more than twice, or less than half, the programmed volume.

- Select YES when the volume delivered matches the volume displayed on this screen.
- Select NO to enter the volume delivered.

To calibrate:

1. Disconnect the pump tube from the bulkhead fitting.
2. Place the end of the tube over a collection container.
3. Follow the steps in Calibrating Sample Volumes in the margin.

Reconnect the pump tube to the bulkhead fitting.

### 4.13 Operating the Pump

#### Operating the Pump

GRAB SAMPLE  
CALIBRATE VOLUME  
**OPERATE PUMP**  
MOVE DISTRIBUTOR

SELECT DIRECTION  
PUMP FORWARD  
PUMP REVERSE

PURGING...  
PRESS THE RED 'STOP'  
KEY WHEN DONE

PURGED \_\_\_\_COUNTS

You can manually operate the sampler's pump in the forward or reverse direction. You can do this to test the pump, draw a large sample, or purge the suction line.

When you run the pump manually, the sampler reports the number of pump counts during the pump's operation. Use this feature to obtain an estimate of the pump counts required to purge a nonstandard suction line.

You can also manually run the pump from the main menu. Press the "1" key and then ↵ to run the pump in reverse. Press the "3" key and then ↵ to run the pump forward.

#### CAUTION

Tests indicate that the pump produces sound levels in excess of 85db at one meter. PROLONGED EXPOSURE TO THIS SOUND LEVEL COULD RESULT IN HEARING LOSS AND REQUIRES THE USE OF PROTECTIVE EAR PLUGS.

### 4.14 Moving the Distributor Arm

#### Moving the Distributor Arm

GRAB SAMPLE  
CALIBRATE VOLUME  
OPERATE PUMP  
**MOVE DISTRIBUTOR**

- Select MOVE DISTRIBUTOR

GO TO BOTTLE \_\_\_\_  
(1-MAX)

- Enter the bottle number to which you want to move the distributor

NOW AT BOTTLE \_\_\_\_

The sampler lets you reposition the distributor arm. Use this feature to verify a bottle location when installing a bottle kit. You cannot move the distributor arm while the sampler is running a program.

#### CAUTION

DO NOT rotate the distributor arm manually; this will severely damage the distributor drive gears.

## 4.15 Reports

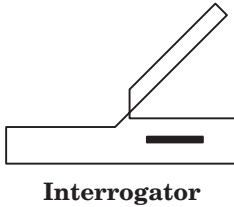

The 6712 records a variety of data while running a sampling program. It uses the data to produce four reports:

- The Program Settings report, listing the program settings.
- The Sampling Results report, listing the program settings, time of samples and other program events.
- The Combined Results report, combining the sample event times with rainfall or module data.
- The Summary report, listing daily summaries of data collected. The Summary report may be rainfall and/or module data.

The sampler stores the data for each report in memory where they remain until you select RUN. Selecting RUN clears the memory so that it can store the data from the next program.

### 4.15.1 Collecting Reports



There are a number of ways to collect the reports:

View reports (program settings, sampling results, and abbreviated summary reports) on the sampler's display.

Collect the reports (except for summary reports) with an Isco 581 RTD and use a computer running Flowlink to transfer the reports from the RTD to a file on the computer.

**Note**

The RTD is not compatible with samplers running software version 2.50. Refer to Section 1.4.5 for complete information.

Collect the reports (except for summary reports) with a computer running Flowlink.

### 4.15.2 Viewing the Data

Because the display area is small, the data on the reports will be displayed a little differently from the data that is transferred to and viewed on your computer.

- For the Sampling Report, the sampler displays each program event, one at a time.
- For the Module and Rainfall Data reports, it displays daily summaries, instead of the full reports available with the rtd, Flowlink.

If you select Sampling Report or Rainfall (step 3 in *Viewing Data*, shown in the margin), the sampler begins displaying the report data. The sampler advances automatically through the report items, displaying each item briefly. While the sampler advances automatically through the displays:

- Stop the automatic displays by pressing Stop once. Then, use the arrow keys to move manually through the report.



### Viewing Data

1

RUN PROGRAM <b>VIEW REPORT</b> OTHER FUCTIONS
--

- Select VIEW REPORT.

2

<b>VIEW DATA</b> SYSTEM ID <sub>s</sub> CONFIGURE REPORTS
---

- Select VIEW DATA.

3

SELECT DATA TO VIEW: SAMPLING REPORT <b>MODULE DATA</b> RAINFALL DATA
--

- Select a report or data type.

4

VIEW: DAILY SUMMARY CURRENT READINGS
--

- Select DAILY SUMMARY to view the stored data, or CURRENT READINGS to view real-time data.

- Return to the main menu by pressing Stop twice.

At the end of the report, the sampler leaves the last item displayed until you press:

- the arrow keys to move forward or backward manually through the report.
- Stop to return to the main menu.
- ↵ to start the automatic displays again.

If you select Module Data in step 3, the sampler displays the screen shown in step 4. Select the Daily Summary option and the sampler displays the stored data just as the Sampling Report was described above. Selecting the current readings option causes the sampler to display real-time readings. When there are multiple screens, they will be displayed alternately. You can quickly advance through the screens by pressing an arrow key or ↵. Pressing Stop exits the Current Readings mode.

### 4.15.3 Configuring Reports

1

RUN PROGRAM <b>VIEW REPORT</b> OTHER FUCTIONS
--

- Select VIEW REPORT.

2

VIEW DATA SYSTEM ID <sub>s</sub> <b>CONFIGURE REPORTS</b>
---

- Select CONFIGURE REPORTS

3

FLOWLINK REPORT CUSTOM REPORT ALL REPORTS
---

- Select the option that matches your data collection software, or tailor the output according to the reports needed.

The Configure Reports option lets you specify which of the Sampling Reports will be included in any output request. Each sampler is shipped with the option Flowlink report selected.

The Flowlink Report options allow you to tailor the output to the Isco software used to collect the reports.

Flowlink Report provides the Sampling Reports and the detailed partition data. Selecting the Flowlink Report option enables the output of the detailed partition data so Flowlink can add the data to the site's database file.

When you are familiar with the available Sampling Reports, you may want to specify an output containing only the specific data you require. The Custom Report option will allow selection of detailed data. Data collection time and storage space may be optimized using this option.

#### 4.15.4 Sampling Results Report

As the sampler runs a program, it records the program's events. Program events include such items as sample events, program enables and disables, power losses, and so on. Table 4-3 lists each event with a short description. You can view the report by following the steps in *Viewing the Data* on page 4-18 or print the log as the Sampling Results report.

In the text file version of the report, sample-event entries include the time of the event as well as the sample and bottle numbers.

The sample column contains the sample number deposited into the bottle. This information reflects the distribution selected for the program.

The letters in the Source columns are codes for the cause of the event. The letters in the Error column are codes for the causes of missed samples. The source and error codes appear with explanations at the end of the report. A list of codes appears in Table 4-3.

The last column in the Sampling Results report records the pump counts for the sample event. Large variations in pump counts from event to event indicate fluctuating heads, a relocated suction line, or a temporarily clogged strainer.

#### 4.15.5 Combined Results Report

At the time of each sample event, the sampler records the readings from each connected module, rain gauge, or SDI-12 sonde. The Combined Results Report presents the event time, sample and bottle number, and the respective readings from the device.

For flow modules, the readings are level and flow rate. For the pH module, the readings are temperature and pH. For the rain gauge and SDI-12 Sonde, the readings vary according to the selections enabled during the hardware setup in extended programming. When recording four or more sonde parameters, the Combined Results report will exceed the standard 40 character width. To read the additional columns, the data must be collected with Flowlink 5.1 for Windows software.

#### 4.15.6 Summary Report

This report summarizes the rain gauge or module data. The types of readings are the same as those available to the Combined reports. The sampler compiles the data to present a daily total, the day's average, maximum, and minimum reading, and a listing of hourly averages. The sampler then graphs the day's readings.



**Table 4-3 Reports: Program Events, Source Codes, and Error Codes**

* Indicates events and codes that occur in Standard Programming	
<b>Program Events</b> (listed in the order that they most likely would occur)	
*Program Run	The sampler ran the sampling program.
*Program Started	The sampler started the sampling program.
*Program Enabled (Disabled)	The sampler was enabled or disabled according to program settings or an external instrument.
'A'/'B' Enabled (Disabled)	Program part 'A' or 'B' was enabled or disabled according to the program's settings.
Sample	A sample was taken as programmed. (See Source Codes and Error Codes in this table.)
*Sample Switch Time	A sample was taken at programmed switch time.
*Program Done	The sampler finished the sampling program.
'A'/'B' Done	The sampler finished program part 'A' or 'B'.
*Manual Pause	Stop was pressed during the program to enter the Manual Paused state.
*Program Stopped	You selected Stop from the manual paused options, terminating the program.
*Grab Sample	A grab sample was taken while in the Manual Paused state.
Pump Tube Replaced	The pump tube alarm was reset while in the Manual Paused state.
Calibrate Volume	The volume was calibrated.
Calibrate SDI Parameter	An SDI-12 sonde or module parameter was calibrated.
*Adjusted Pacing	The pacing interval was changed while in the Manual Paused state.
*Volume Changed	Sample volume was changed while in the Manual Paused state.
Adjust Enable	Sampler enable thresholds were changed while in the Manual Paused state.
Reset Rain History	The rain history was reset.
Adjust Suction Head	The suction head was changed while in the Manual Paused state.
*Manual Resume	The resume program option was selected from the Manual Paused state.
Program Paused (Resumed)	The program reached a programmed pause or resume time.
'A'/'B' Paused (Resumed)	Program part 'A' or 'B' reached a programmed pause or resume time.
*Power Failed	The power source was disconnected.
*Power Restored	The power source was reconnected.
Alarm Occurred	An alarm occurred.
Alarm Acknowledged	An alarm was acknowledged.
*Missed Password	The password was missed.

**Table 4-3 Reports: Program Events, Source Codes, and Error Codes (Continued)**

(The Source and Error Codes Listed below refer to why a sample was taken and what happened while it was being taken.)

Source Codes		
*C	Calibrate sample	Sample volume delivered during calibration.
*D	Disable	Sample event at disable time.
*E	Enable	Sample event at enable time.
Ev	Event	Event-paced sample event.
*F	Flow	Flow-paced sample event.
*G	Grab sample	Sample volume delivered as a grab sample.
M	Command driven sample	A command driven sample.
PH	Phone command	Phone command sample.
R	Resume	Sample event at resume time.
*S	Start	Sample event at start time.
Sw	Switch time	Sample event at switch time.
TO	Time Override	Sample event at bottle-switch time.
*T	time	Time-paced sample event.
Error Codes		
*DJ	Distributor Jammed	The distributor jammed.
*IP	sample in progress	Sample in progress when report was printing.
*L	pump latch open	Unable to take sample because the pump band was opened.
*ND	no distributor arm	There is no distributor arm or the stop is damaged.
*NL	No Liquid Detected	The sampler was unable to detect liquid.
LF	Not enough flow	Not enough flow for the minimum sample volume entered for samples with volumes proportional to flow.
*NM	No More Liquid	After the sampler detected liquid and while the sample was being taken, the liquid detector stopped detecting liquid.
M	Bottle Full	The composite bottle is full.
*O	Sampler Shut Off	The sampler was turned off with the On-Off key during the sample event.
Ov	Probable Overflow	The sampler was directed to take a sample that would not fit into the bottle. Occurs for flow paced, time override programs only.
*P	Power Failed	The power supply failed during the sample event. Note: Power failures during five consecutive sample events results in a LOW BATTERY shut-down.
*PJ	Pump Jammed	The pump jammed.
*Sk	Sample Skipped	Sample not taken.
*US	User Stopped	You pressed the Stop key during the sample event.

Figures 4-5, 4-6, 4-7, 4-8, and 4-9 show examples of reports configured to show program settings, sampling results, combined results, and a summary report.

```
SAMPLER ID# 3687447734 06:32 19-DEC-02
Hardware: A0          Software: 1.02
***** PROGRAM SETTINGS *****
-----

SITE DESCRIPTION:
"FACTORY051"

-----

UNITS SELECTED:
FLOW RATE: cfs
FLOW VOLUME: Mgal

-----

BUBBLER MODULE:
WEIR
90
V-NOTCH

-----

24, 1000 ml BTLS

10 ft SUCTION LINE

-----

PACING:
TIME, EVERY
0 HOURS, 15 MINUTES

-----

DISTRIBUTION:
SEQUENTIAL

-----

200 ml SAMPLES

-----

5 MINUTE DELAY TO
FIRST SAMPLE

-----
```

Figure 4-5 Report: Program Settings

6712FR Refrigerated Sampler  
 Section 4 Standard Programming

---

SAMPLER ID# 3687447734 06:32 19-DEC-02  
 Hardware: A0 Software: 1.02  
 \*\*\*\*\* SAMPLING RESULTS \*\*\*\*\*  
 SITE: FACTORY051  
 Program Started at 15:03 WE 18-DEC-02  
 Nominal Sample Volume = 200 ml

SAMPLE	BOTTLE	TIME	SOURCE ERROR	COUNT TO LIQUID
		15:03	PGM ENABLED	
1,1	1	15:03	S	250
1,1	2	15:18	T	247
1,1	3	15:33	T	247
1,1	4	15:48	T	249
1,1	5	16:03	T	247
1,1	6	16:18	T	247
1,1	7	16:33	T	247
1,1	8	16:48	T	248
1,1	9	17:03	T	237
1,1	10	17:18	T	236
1,1	11	17:33	T	237
1,1	12	17:48	T	241
1,1	13	18:03	T	238
1,1	14	18:18	T	236
1,1	15	18:33	T	237
1,1	16	18:48	T	236
1,1	17	19:03	T	242
1,1	18	19:18	T	237
1,1	19	19:33	T	235
1,1	20	19:48	T	238
1,1	21	20:03	T	237
1,1	22	20:18	T	237
1,1	23	20:33	T	236
1,1	24	20:48	T	230
		20:48	PGM DONE 19-DEC	

SOURCE S ==> START  
 SOURCE T ==> TIME

Figure 4-6 Report: Sampling Results

SAMPLER ID# 3687447734 06:32 19-DEC-02

Hardware: A0 Software: 1.02

BUBBLER MODULE: 2215419583

Hardware: A00000 Software: 1.07

\*\*\*\*\* COMBINED RESULTS \*\*\*\*\*

SITE: FACTORY051

Program Started at 15:03 WE 18-DEC-02

Nominal Sample Volume = 200 ml

SAMPLE	BOTTLE	TIME	LEVEL ft	FLOW RATE cfs	TOTAL FLOW Mgal
1,1	1	15:03	0.009	2.495	000000.000
1,1	2	15:18	0.012	2.576	000000.017
1,1	3	15:33	0.012	2.666	000000.035
1,1	4	15:48	0.012	2.773	000000.053
1,1	5	16:03	0.012	2.773	000000.072
1,1	6	16:18	0.012	2.798	000000.091
1,1	7	16:33	0.012	2.798	000000.109
1,1	8	16:48	0.012	2.798	000000.128
1,1	9	17:03	0.012	2.751	000000.147
1,1	10	17:18	0.012	2.773	000000.166
1,1	11	17:33	0.009	2.798	000000.185
1,1	12	17:48	0.012	3.728	000000.207
1,1	13	18:03	0.012	3.728	000000.232
1,1	14	18:18	0.012	3.728	000000.257
1,1	15	18:33	0.009	3.728	000000.282
1,1	16	18:48	0.012	5.273	000000.317
1,1	17	19:03	0.012	5.239	000000.353
1,1	18	19:18	0.012	6.651	000000.397
1,1	19	19:33	0.009	6.651	000000.442
1,1	20	19:48	0.009	6.651	000000.486
1,1	21	20:03	0.012	6.651	000000.531
1,1	22	20:18	0.012	6.651	000000.576
1,1	23	20:33	0.009	3.404	000000.612
1,1	24	20:48	0.012	3.425	000000.634

Figure 4-7 Report: Combined Results

6712FR Refrigerated Sampler  
Section 4 Standard Programming

---

```
SAMPLER ID# 3687447734 06:32 19-DEC-02
  Hardware: A0      Software: 1.02
***** COMBINED RESULTS *****
  SITE: FACTORY051
Program Started at 15:03 WE 18-DEC-02
Nominal Sample Volume = 200 ml
                        FR-TEMP
SAMPLE  BOTTLE TIME      C
-----
                        NO FR-TEMPERATURE
-----
```

```
SAMPLER ID# 3687447734 06:32 19-DEC-02
  Hardware: A0      Software: 0.01.0127
***** COMBINED RESULTS *****
  SITE: FACTORY051
Program Started at 15:03 WE 18-DEC-02
Nominal Sample Volume = 200 ml
SAMPLE  BOTTLE TIME
-----
                        NO RAIN GAUGE
-----
```

```
SAMPLER ID# 3687447734 06:32 19-DEC-02
  Hardware: A0      Software: 0.01.0127
SDI-12 DATA
***** COMBINED RESULTS *****
  SITE: FACTORY051
Program Started at 15:03 WE 18-DEC-02
Nominal Sample Volume = 200 ml

                        NO SDI-12 SONDE
-----
```

Figure 4-8 Report: Combined Results (continued)

SAMPLER ID# 3687447734 16:41 20-DEC-02  
 Hardware: A0 Software: 1.02  
 BUBBLER MODULE: 2215419583  
 Hardware: A00000 Software: 1.07  
 SITE: FACTORY051

Summary Report for 19-DEC-02 (TH)  
 Day's Flow: 000000.054 Mgal  
 Average Flow Rate: 0.4437 cfs  
 07:20 Minimum Flow Rate: 0.0237 cfs  
 13:25 Maximum Flow Rate: 7.0207 cfs  
 Hourly Average Flow Rate:  
 00:00-01:00: NO DATA  
 01:00-02:00: NO DATA  
 02:00-03:00: NO DATA  
 03:00-04:00: NO DATA  
 04:00-05:00: NO DATA  
 05:00-06:00: NO DATA  
 06:00-07:00: NO DATA  
 07:00-08:00: NO DATA  
 08:00-09:00: 2.519 cfs  
 09:00-10:00: 2.747 cfs  
 10:00-11:00: 2.791 cfs  
 11:00-12:00: 3.456 cfs  
 12:00-13:00: 5.385 cfs  
 13:00-14:00: 6.651 cfs  
 14:00-15:00: 2.591 cfs  
 15:00-16:00: 1.593 cfs  
 16:00-17:00: NO DATA  
 17:00-18:00: NO DATA  
 18:00-19:00: NO DATA  
 19:00-20:00: NO DATA  
 20:00-21:00: NO DATA  
 21:00-22:00: NO DATA  
 22:00-23:00: NO DATA  
 23:00-24:00: NO DATA

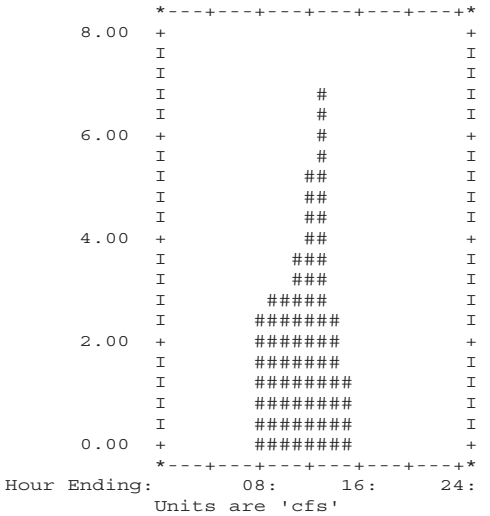

Figure 4-9 Report: Summary

## 4.16 System IDs

### System IDs

```
  RUN
  PROGRAM
  VIEW REPORT
  OTHER FUNCTIONS
```

- Select VIEW REPORT.

```
  VIEW DATA
  SYSTEM IDs
  CONFIGURE REPORTS
```

- Select SYSTEM IDs.

```
  SAMPLER
  6712 ID _____
  HARDWARE:  __
  SOFTWARE:  __
```

- Displayed briefly

```
  [MODULE TYPE]
  [MODEL #] ID: _____
  HARDWARE:  __
  SOFTWARE:  __
```

- Displayed briefly

```
  SOFTWARE OPTIONS
  [Options List]
```

- Press STOP to return to the main menu.

## 4.17 Programming for 700 Series Modules

In addition to viewing report data and configuring reports, the View Report option on the main menu lets you view system identification information.

The sampler reports the sampler model number, ID (identification number), and software version number as system identification notes. The sampler also reports the same information for an attached module.

The model and ID numbers remain unchanged through the life of the sampler. The ID numbers appear on the sampler's reports and in files created by Flowlink and when they interrogate the sampler. The software packages use the ID number to make sure that data from different samplers is not combined in the same file.

The software version number changes when your sampler's software is updated.

The system will also list any software options that you have activated on your unit. These software options are discussed in Section 5.

The bay on the controller's side accepts any of Teledyne Isco's 700 Series Modules. These modules are optional accessories that are not required for operation of the 6712. However, the modules offer an economical way to combine flow-rate or parameter monitoring with sampling.

The programming of these modules is integrated with the programming of the sampler, so attachment of a module will cause different screens to be displayed, depending on the type of module and the selections you make while programming.

Two modules that are commonly used are the 730 Bubbler Module, which monitors a flow stream's level and flow rate, and the 750 Area Velocity Module for monitoring a flow stream's level, velocity, and flow rate. The following sets of screens give you an example of what screens you might see while programming the sampler and module. Refer to Table 4-1 (which does not have a module attached) at the beginning of this section to compare the sequence of screen displays.



**CAUTION**

Most Isco accessories and interfacing equipment are not certified for use in hazardous locations as defined by the National Electrical Code. Check applicable guidelines, codes, and regulations of federal, state, city, and county agencies. Refer to Appendix C in the back of this manual for more safety information.

**Table 4-4 Programming Example With 730 Module Installed**

1	MODULE INSERTED--- DOWNLOAD DATA NOW OR LOSE ALL DATA! DONE	With the sampler off, insert the module in the bay on the controller. Turn the sampler on by pressing the On/Off key. Press ↵. Download stored data, if you want to keep it. Pressing DONE erases it and advances to the next screen.
2	6712 SAMPLER STANDARD PROGRAMMING For HELP at any screen press ? key.	This screen will now appear for 8 seconds.
3	RUN <b>PROGRAM</b> VIEW REPORT OTHER FUNCTIONS	The option PROGRAM will be blinking. Press ↵.
4	SITE DESCRIPTION: "FACTORY051" CHANGE? YES NO	The option NO will be blinking. Press ↵. For the purposes of this example, it isn't necessary to change the description.
5	SELECT UNITS FOR FLOW RATE: <b>cfs</b> gps gpm Mgd lps m3s m3h m3d	Select the desired units for the flow rate. For this example, choose cfs. Press ↵.
6	SELECT UNITS FOR FLOW VOLUME: cf gal <b>Mgal</b> m3 lit	Select the desired units for the flow volume. For this example, choose Mgal. Press ↵.
7	PROGRAM MODULE? <b>YES</b> NO	Select YES to program the module.
8	MODE OF OPERATION: FLOWMETER LEVEL ONLY	If you choose Flowmeter, proceed to screen #9 below. If you choose LEVEL ONLY, proceed to screen #12.
9	<b>WEIR</b> FLUME DATA POINTS EQUATION MANNING FLOW-INSERT	When you select Flowmeter, you will have several options for performing the flow conversion. For this example, choose Weir. Press ↵.

**Table 4-4 Programming Example With 730 Module Installed (Continued)**

10	V-NOTCH RECTANGULAR CIPOLLETTI	For this example, choose V-Notch. Press ↵.
11	V-NOTCH WEIR ANGLE: 120 <b>90</b> 60 45 30 22.5	For this example, choose a Weir angle of 90. Press ↵.
12	CURRENT LEVEL IS _._ ft ADJUST LEVEL TO _._ ft	The current level will be displayed. Enter an adjustment if needed. If the adjustment is different by more than 0.50 ft, you will be prompted "ARE YOU SURE? YES NO" Choose NO to re-enter; select YES if correct. Press ↵.
13	NUMBER OF BOTTLES: 1 2 4 8 12 <b>24</b>	Select the number of bottles in your bottle kit by pressing either arrow key until the correct number blinks. Press ↵. For this example, select 24.
14	BOTTLE VOLUME IS 1000 ml (300-30000)	Type the volume for the bottles in your kit. For this example, 1000 is correct, so simply press ↵.
15	SUCTION LINE LENGTH IS 10 ft (3-99)	Type the length of the suction line, then press ↵. If you change the length, the sampler will display a message, "PLEASE WAIT! . . . GENERATING PUMP TABLES."
16	TIME PACED <b>FLOW PACED</b>	Select FLOW PACED. If the module is being used as a flowmeter, you will see screen #17a. If the module is being used for level only, you will see screen #17b.
17a	FLOW BETWEEN SAMPLE EVENTS: <b>0.075 Mgal</b> (0.001 - 99999)	If the module is being used as a flowmeter, choose the amount of flow between sample events.
17b	FLOW BETWEEN SAMPLE EVENTS: <b>2 PULSES</b> (1-9999)	If the module is being used for level only, enter the number of pulses between sample events.
18	SEQUENTIAL <b>BOTTLES/SAMPLE</b> SAMPLES/BOTTLE	Select BOTTLES/SAMPLE.
19	<b>2 BOTTLES PER</b> SAMPLE EVENT (1-24)	Enter 2.
20	RUN CONTINUOUSLY? YES <b>NO</b>	Select NO.
21	SAMPLE VOLUME: <b>250 ml</b> (10-1000)	Enter 250.

**Table 4-4 Programming Example With 730 Module Installed (Continued)**

22	NO DELAY TO START DELAYED START <b>CLOCK TIME</b> WAIT FOR PHONE CALL	Select <b>CLOCK TIME</b> .
23	START FLOW COUNT AT: 06:00	Enter 6, then enter 0.  This is the time at which the sampler will start the pacing countdown.
24	SELECT DAYS: SU <b>MO</b> TU <b>WE</b> TH <b>FR</b> SA  DONE	Select <b>MO</b> , <b>WE</b> , and <b>FR</b> . Use the arrow keys and ↵ to select <b>MO</b> , <b>WE</b> , and <b>FR</b> . When the correct days are blinking, select <b>DONE</b> and press ↵.
25	PROGRAMMING COMPLETE RUN THIS PROGRAM NOW? YES <b>NO</b>	Select <b>NO</b> .

**Table 4-5 Programming Example With 750 Module Installed**

1	MODULE INSERTED--- DOWNLOAD DATA NOW OR LOSE ALL DATA! DONE	With the sampler off, insert the module in the bay on the controller. Turn the sampler on by pressing the On/Off key. Press ↵. Download stored data, if you want to keep it. Pressing <b>DONE</b> erases it and advances to the next screen.
2	6712 SAMPLER STANDARD PROGRAMMING For HELP at any screen press ? key.	This screen will now appear for 8 seconds.
3	RUN <b>PROGRAM</b> VIEW REPORT OTHER FUNCTIONS	The option <b>PROGRAM</b> will be blinking. Press ↵.
4	SITE DESCRIPTION: "FACTORY051" CHANGE? YES <b>NO</b>	The option <b>NO</b> will be blinking. Press ↵. For the purposes of this example, it isn't necessary to change the description.
5	SELECT UNITS FOR FLOW RATE: <b>cfs</b> gps gpm Mgd lps m3s m3h m3d	Select the desired units for the flow rate. For this example, choose <b>cfs</b> . Press ↵.
6	SELECT UNITS FOR FLOW VOLUME: cf gal <b>Mgal</b> m3 lit	Select the desired units for the flow volume. For this example, choose <b>Mgal</b> . Press ↵.
7	SELECT UNITS FOR VELOCITY: <b>fps</b> mps	Select the desired units for the flow velocity. For this example, choose <b>fps</b> . Press ↵.

**Table 4-5 Programming Example With 750 Module Installed (Continued)**

8	PROGRAM MODULE? YES NO	Select YES to program the module.
9	MODE OF OPERATION: FLOWMETER LEVEL AND VELOCITY	The 750 can have two different modes of operation: Flowmeter or Level and Velocity. For this example, choose Flowmeter. Press ↵.
10	FLOW CALCULATION: AREA * VELOCITY LEVEL TO FLOW RATE	When you select Flowmeter, you will have two options for performing the flow conversion: Area * Velocity or Level to Flow Rate. For this example, choose Area * Velocity. Press ↵.
11	LEVEL TO AREA: CHANNEL SHAPE DATA POINTS	For this example, choose Channel Shape. Press ↵.
12	ROUND PIPE U-CHANNEL RECTANGULAR CHANNEL TRAPEZOIDAL CHANNEL	For the channel shape, select Round Pipe. Press ↵.
13	ROUND PIPE DIAMETER = 2.00 ft	Enter the diameter of the round pipe. Press ↵.
14	CURRENT LEVEL IS ... ft ADJUST LEVEL TO ... ft	The current level will be displayed. Enter an adjustment if needed. If the adjustment is different by more than 0.50 ft, you will be prompted "ARE YOU SURE? YES NO" Choose NO to re-enter; select YES if correct. Press ↵.
15	ZERO LEVEL OFFSET: ... ft	Enter the amount of zero level offset. Press ↵.
16	MAXIMUM DEPTH FOR VELOCITY MEASUREMENT 2" 3" 4"	(This screen is applicable for standard-sized probes only.) Select the maximum depth for the velocity measurement. Press ↵.
17	NUMBER OF BOTTLES: 1 2 4 8 12 24	Select the number of bottles in your bottle kit by pressing either arrow key until the correct number blinks. Press ↵.

From this point forward, the screens will be the same as in Table 4-2.

# 6712FR Refrigerated Sampler

## Section 5 Extended Programming

The 6712FR Sampler has two sets of programming screens. The first set, called standard programming screens, lets you set up typical sampling programs easily and efficiently. The second set, extended programming screens, lets you create sophisticated programs for complex sampling applications.

All of the sampling features available with standard programming screens, discussed in Section 4, are available with extended programming screens. However, the extended screens provide several additional features and some screen display differences which are discussed in this section. The menu flowcharts for both sets of programming screens are in Appendix A, Menu Flowcharts.

### **Note**

This section assumes that you have read, and are familiar with, the instructions in Section 4, Standard Programming!

### 5.1 Extended and Standard Mode

The sampler is shipped with factory default settings in standard programming mode when you first turn the sampler on. The start-up screen tells you which programming mode the sampler is currently using. You can switch between programming modes by entering a numerical command at the main menu:

At the main menu type **6712.2** to enter extended programming mode.

At the main menu type **6712.1** to enter standard programming mode.

```
RUN "EXTENDED 1"  
PROGRAM  
VIEW REPORT  
OTHER FUNCTIONS
```

**Main Menu for Extended Mode**

### 5.2 One-Part and Two-Part Programs

Extended programming lets you set up a “one-part” program or a “two-part” program. One-part programs let you fill all bottles of the tub with one set of pacing, distribution, and enable settings. Two-part programs add an additional set of extended pacing, distribution, and enable screens to the sampling program. Each set of screens is called a program part. The program parts are simply called part ‘A’ and part ‘B’. Both parts share the program settings for suction-line length, suction head, and rinses and retries. They also share one start-time setting.

Each part has its own group of bottles. Because settings for each part are independent of each other, the sampler, when running a two-part program, fills each bottle group as if they were being filled by two different programs. Two-part programs finish when both parts are done.

Two-part programming is ideal for sampling storm events. Many storm-water run-off monitoring permits require a first-flush grab sample within the first 30 minutes of the storm event and flow-paced samples during the remainder of the event. With a two-part program, you can set up part 'A' for the first-flush sample and part 'B' for the remainder. Table 5-2 shows a storm-water sampling program.

### 5.3 Storage for Extended Programs

The sampler stores five sampling programs: one standard and four extended. Program storage eliminates the need to reprogram the sampler with frequently used settings. This feature is especially useful for complex extended programs such as two-part programs or programs with many nonuniform-time settings.

Teledyne Isco ships the sampler to you with factory programs that you can modify to suit your own needs. All four extended programs are identical to each other.

The stored programs will also save your 700 Series Module program settings and any sampler enable conditions using rain gauge data or SDI-12 sonde parameters. These program settings remain as long as you do not change the type of module, or change the rain gauge or SDI-12 Hardware Setup.

#### 5.3.1 Selecting a Stored Program

When the sampler is in extended programming mode, it always has one current and three noncurrent programs, each occupying a permanent location in memory. The first time you access the extended mode, the current program is "EXTENDED 1," one of the factory extended programs. The name of the current extended program appears in quotations on the first line of the main menu.

The factory programs are named "EXTENDED 1," "EXTENDED 2," "EXTENDED 3," and "EXTENDED 4." You can rename them with more descriptive names, making them easier to identify. The program name is one of the extended program's settings.

After selecting a stored program, review the settings with the quick view screens. Each sampling program stores all the settings required by the sampler to run a program. These settings include the bottle-kit information (number of bottles and the bottle volume), the suction-line length, the site description, start times, and so on.

If you use the same program at two sites — each requiring different bottle configurations, suction line lengths, or other details — always check these settings before running a program. You may need to make minor changes to the program to make sure the settings match your equipment.

The current program is the program you see when you select PROGRAM from the main menu and page through the programming screens. It is the program the sampler uses when you select RUN from the main menu.

You cannot delete programs, but you can modify them as often as necessary. To run a program with different settings without losing the settings in your current program, select a stored program and modify its settings.

For example, assume you have been running the current program, named "EXTENDED 1," at site A for several weeks. This program contains all the settings you need for site A, and you don't want to lose those settings.

Nevertheless, you need another program because you want to move the sampler to site B, so you select "EXTENDED 2" and modify it for site B. The settings in "EXTENDED 1" are preserved automatically. When you return the sampler to site A, you won't need to reprogram the sampler. Merely select "EXTENDED 1" again, double-check the program settings, and run the program. To select an extended program, follow the steps in Table 5-1.

**Table 5-1 Selecting a Stored Extended Program**

1	<p>6712 SAMPLER, EXTENDED PROGRAMMING For HELP at any screen, press ? key.</p>	<p>Press the On/Off key to turn the sampler on. Press ↓ to clear the start-up message. If the words "STANDARD PROGRAMMING" appear on the second line of the start-up message, the sampler is using the standard programming screens. To see the extended screens, type <b>6712.2</b> at the main menu shown in step 2.</p>
2	<p>RUN "EXTENDED 1" PROGRAM VIEW REPORT OTHER FUNCTIONS</p>	<p>Select PROGRAM from the main menu.</p>
3	<p>PROGRAM NAME: "EXTENDED 1" SITE DESCRIPTION: "_____"</p>	<p>Select PROGRAM NAME: "EXTENDED 1" from the quick view menu.</p>
4	<p>SELECT NEW PROGRAM CHANGE PROGRAM NAME</p>	<p>Select SELECT NEW PROGRAM to change the program. You can go through QUICK VIEW screens quickly by pressing ↓ at each screen. You can also change settings in quick view screens; see <i>Changing Settings in a Quick View Screen</i> on page 3-4.</p>
5	<p>"EXTENDED 1" "EXTENDED 2" "EXTENDED 3" "EXTENDED 4"</p>	<p>Select the name of the extended program you want to use. Each program's name appears on the same line. If you inadvertently give two programs identical names, you can still identify them by their location on the screen.</p>
6	<p>PROGRAMMING COMPLETE RUN THIS PROGRAM NOW? YES NO</p>	<p>To run the program immediately, select YES. To run the program later, select NO.</p>
7	<p>RUN "EXTENDED 2" PROGRAM VIEW REPORT OTHER FUNCTIONS</p>	

## 5.4 Programming for 700 Series Modules

The bay on the controller's side accepts any of Teledyne Isco's 700 Series Modules. These optional accessories are not required to operate the 6712FR. However, the modules offer an economical way to combine flow-rate or parameter monitoring with sampling.

The programming of these modules is integrated with the programming of the sampler, so attachment of a module will cause different screens to be displayed, depending on the type of module and the selections you make while programming.

Two modules that are commonly used are the 730 Bubbler Module, which monitors a flow stream's level and flow rate, and the 750 Area Velocity Module for monitoring a flow stream's level, velocity, and flow rate. Section 4 contains two examples of programming for modules. Module programming is the same in Extended as it was in Standard programming.

## 5.5 Programming Examples

In addition to the features available with standard programming, and discussed in Section 4, extended programming offers:

- Nonuniform time pacing
- Random interval pacing
- Event pacing
- Multiple bottle compositing
- Time switched bottles or bottle sets
- Programmable sampler enable
- Pauses and resumes
- Two-part programming
- Automatic or user-defined suction head
- Suction line rinses
- Sampling retries

This manual provides several programming examples. Some, demonstrating simple tasks, appear in the margins. Others, demonstrating more complex tasks, appear as examples. Table 5-2 on the following pages steps you through a storm water runoff sampling using extended programming.

### 5.5.1 Storm Water Runoff Sampling

Storm water runoff sampling is an ideal application for two-part programming. Typical monitoring permits require that a series of timed samples be taken during the initial portion of the storm event, followed by flow paced samples during the remainder of the event.

This example assumes that a Rain Gauge and a Bubbler Flow Module are connected to the sampler.

 <b>Note</b>
---

To enable the Bubbler Module programming screens, insert the module before turning on the sampler



Using a 24-bottle kit, it divides the bottles into two groups, with six bottles assigned to part 'A' and 18 to part 'B.' The sampler will begin taking samples after being enabled according to programmable enable controls; that is, when the rain gauge detects 0.15 inches of rainfall in 30 minutes, and the module detects a flow stream level of more than 0.25 feet. Because both program parts use the same enable settings, the sampler will enable both parts at the same time. A list of settings for the program follow:

- Program type: Extended.
- Program name: STORM.
- Site description: SITE 54.
- Units: Length – Ft, Flow Rate – gpm, Flow Volume – gal
- Mode of Operation: Flowmeter, Flow-Insert, Round, 12"
- Bottle kit: 24, 1000-milliliter bottles.
- Suction-line length: 5 feet.
- Suction head: Auto suction head.
- Line rinses: None.
- Sampling retries: None.
- Part 'A' and 'B' bottle assignments: Bottles 1 - 6 to part 'A', bottles 7 - 24 to part 'B'.
- Part 'A' pacing: Time pacing, sampling every 5 minutes.
- Part 'A' distribution: Sequential, 1 sample per bottle.
- Part 'A' sample volume: 800 milliliters.
- Part 'A' enable: At least 0.15 inches of rainfall in 30 minutes and a flow stream level of more than 0.25 feet; once enabled, stay enabled, sample taken when the sampler is enabled.
- Part 'A' pause and resumes: None.
- Part 'B' pacing: Flow pacing, sampling every 2,500 gallons.
- Part 'B' distribution: Sequential, 1 sample per bottle.
- Part 'B' sample volume: 500 milliliters.
- Part 'B' enable: At least 0.15 inches of rainfall in 30 minutes and a flow stream level of more than 0.25 feet; once enabled, stay enabled, no sample taken when the sampler is enabled; first sample taken 20 minutes after the sampler is enabled.
- Part 'B' pause and resumes: None.
- Start time: Delayed start of 1 minute.
- 730 Bubbler Module: Installed

**Table 5-2 Storm Water Runoff Sampling**

1	6712 SAMPLER EXTENDED PROGRAMMING For HELP at any screen press ? key.	This screen will appear briefly.
2	RUN "EXTENDED 1" <b>PROGRAM</b> VIEW REPORT OTHER FUNCTIONS	Select PROGRAM. Note: If the start-up screen displayed "STANDARD PROGRAMMING", type <b>6712.2</b> at this menu before selecting PROGRAM.
3	PROGRAM NAME: "EXTENDED 1 " CHANGE? <b>YES</b> NO	Select YES. Note: If the quick view screen shows up, press STOP then select OTHER FUNCTIONS, SOFTWARE OPTIONS, QUICKVIEW/CHANGE, NORMAL. Then press STOP and go back to step 2.
4	SELECT NEW PROGRAM <b>CHANGE PROGRAM NAME</b>	Select CHANGE PROGRAM NAME.
5	NAME: "STORM " ABCDEFGHIJKLMNQRST UVWXYZ-& 0123456789 BACK-UP DONE	Enter the word "STORM" for the program name.
6	SITE: DESCRIPTION "FACTORY051" CHANGE? <b>YES</b> NO	Select YES.
7	SITE: "SITE 54 " ABCDEFGHIJKLMNQRST UVWXYZ-& 0123456789 BACK-UP DONE	Enter "SITE 54" for the site description.
8	SELECT UNITS FOR LENGTH: <b>ft</b> m	Select ft.
9	SELECT UNITS FOR FLOW RATE cfs gps <b>gpm</b> Mgd lps m3s m3h m3d	Select gpm.
10	SELECT UNITS FOR FLOW VOLUME cf <b>gal</b> Mgal m3 lit	Select gal.
11	PROGRAM MODULE? <b>YES</b> NO	Select YES
12	MODE OF OPERATION <b>FLOWMETER</b> LEVEL ONLY	Select FLOWMETER

**Table 5-2 Storm Water Runoff Sampling (Continued)**

13	WEIR FLUME DATA POINTS EQUATION MANNING <b>FLOW-INSERT</b>	Select FLOW-INSERT.
14	WEIR/ORIFICE TYPE V-NOTCH <b>ROUND</b>	Select ROUND.
15	FLOW INSERT SIZE: 6" 8" 10" <b>12"</b>	Select 12.
16	NEW MODULE SETUP-- DOWNLOAD DATA NOW OR LOSE ALL DATA! DONE	Select DONE. Note: Partition memory status message will be displayed briefly.
17	CURRENT LEVEL IS ____.____ ft. ADJUST LEVEL TO ____.____ ft.	Press ENTER.
18	DATA STORAGE INTERVAL IN MINUTES 1 2 <b>5</b> 10 15 30	Select 5. (If the data storage interval is different from the current program, you will be informed that the storage interval has changed, and that the stored data will be lost. Download stored data (if desired) and select DONE.
19	NUMBER OF BOTTLES: 1 2 4 8 12 <b>24</b>	Select 24.
20	BOTTLE VOLUME IS 1000 ml (300-30000)	Enter 1000.
21	SUCTION LINE LENGTH IS 5 ft (3-99)	Enter 5. The 6712FR calculates new pump tables.
22	<b>AUTO SUCTION HEAD</b> ENTER HEAD	Select AUTO SUCTION HEAD.
23	0 RINSE CYCLES (0-3)	Enter 0.
24	RETRY UP TO 0 TIMES WHEN SAMPLING (0-3)	Enter 0.

**Table 5-2 Storm Water Runoff Sampling (Continued)**

25	ONE-PART PROGRAM TWO-PART PROGRAM	Select TWO-PART PROGRAM.
26	24 BOTTLES AVAILABLE ASSIGN BOTTLES 1 THRU 6 TO PART 'A' (1-23)	Enter 6. Screen will say "Beginning Part A" before proceeding with screen 27.
27	UNIFORM TIME PACED FLOW PACED EVENT PACED NONUNIFORM TIME	Select UNIFORM TIME PACED.
28	TIME BETWEEN SAMPLE EVENTS: 0 HOURS, 5 MINUTES	Enter 0 for hours, 5 for minutes.
29	1 BOTTLES PER SAMPLE EVENT (1- 6)	Enter 1.
30	SWITCH BOTTLES ON: NUMBER OF SAMPLES TIME	Select NUMBER OF SAMPLES.
31	SWITCH BOTTLES EVERY 1 SAMPLES (1-50)	Enter 1.
32	RUN CONTINUOUSLY? YES NO	Select NO.
33	DO YOU WANT SAMPLE VOLUMES DEPENDENT ON FLOW? YES NO	Select NO.
34	SAMPLE VOLUME 200 ml (10-1000)	Enter 800.
35	ENABLE: RAIN LEVEL FLOW NONE	Select RAIN. Note: All valid enable options will appear here, so your screen may differ.
36	ENABLE: RAIN AND OR DONE	Select AND.

**Table 5-2 Storm Water Runoff Sampling (Continued)**

37	ENABLE: RAIN AND LEVEL FLOW NONE	Select LEVEL.
38	"RAIN" SET POINT: 0.15 INCHES PER __ HOURS, __ MINUTES	Enter 0.15 for inches, then enter 30 minutes.
39	ENABLED WHEN: ABOVE SET POINT BELOW SET POINT	Select ABOVE SET POINT.
40	RESET RAIN HISTORY? YES NO	Select YES.
41	"LEVEL" CONDITION: SET POINT RANGE RATE OF CHANGE	Select SET POINT.
42	"LEVEL" SET POINT 0.25 ft (0.001-30.000)	Enter 0.25.
43	ENABLED WHEN: ABOVE SET POINT BELOW SET POINT	Select ABOVE SET POINT.
44	ONCE ENABLED, STAY ENABLED? YES NO	Select YES.
45	SAMPLE AT ENABLE? YES NO	Select YES.
46	PAUSE RESUME 1. HH:MM DD HH:MM DD 2. HH:MM DD HH:MM DD CLEAR DONE	Select DONE. Screen will say "End of Part A" then "Beginning Part B."
47	UNIFORM TIME PACED FLOW PACED EVENT PACED NONUNIFORM TIME	Select FLOW PACED.
48	PACED BY: FLOW PULSES FLOW MODULE VOLUME	Select FLOW MODULE VOLUME.
49	FLOW BETWEEN SAMPLE EVENTS: 2500 gal (0.001-99999)	Enter 2500.

**Table 5-2 Storm Water Runoff Sampling (Continued)**

50	SAMPLE AT START? YES NO	Select YES. This will cause the first sample to be taken 20 minutes (the delay to start of sampling specified in Step 67) after the enable for Part B.
51	1 BOTTLES PER SAMPLE EVENT (1- 18)	Enter 1.
52	SWITCH BOTTLES ON: NUMBER OF SAMPLES TIME	Select NUMBER OF SAMPLES.
53	SWITCH BOTTLES EVERY 1 SAMPLES (1- 50)	Enter 1.
54	RUN CONTINUOUSLY? YES NO	Select NO.
55	SAMPLE VOLUME: 200 ml (10-1000)	Enter 500.
56	ENABLE: RAIN LEVEL FLOW 'A' DONE NONE	Select RAIN.
57	ENABLE: RAIN AND OR DONE	Select AND.
58	ENABLE: RAIN AND LEVEL FLOW 'A' DONE DONE	Select LEVEL.
59	"RAIN" SET POINT: 0.15 INCHES PER __HOURS, __MINUTES	Enter 0.15 for inches, then enter 30 minutes.
60	ENABLED WHEN: ABOVE SET POINT BELOW SET POINT	Select ABOVE SET POINT.
61	RESET RAIN HISTORY? YES NO	Select YES.
62	"LEVEL" CONDITION: SET POINT RANGE RATE OF CHANGE	Select SET POINT.

**Table 5-2 Storm Water Runoff Sampling (Continued)**

63	<p>"LEVEL" SET POINT 0.25 ft (0.100-30.000)</p>	Enter 0.25.
64	<p>ONCE ENABLED, STAY ENABLED? YES NO</p>	Select YES.
65	<p>SAMPLE AT ENABLE? YES NO</p>	Select NO.
66	<p>START OF SAMPLING AFTER A 15 MINUTE DELAY (1-999)</p>	Enter 20.
67	<p>PAUSE RESUME 1. HH:MM DD HH:MM DD 2. HH:MM DD HH:MM DD CLEAR DONE</p>	Select DONE. Screen will say "End of Part B."
68	<p>NO DELAY TO START DELAYED START CLOCK TIME WAIT FOR PHONE CALL</p>	Select DELAYED START.
69	<p>START "STORM" AFTER A 72 HOUR "DRY" PERIOD? YES NO</p>	Select NO. (Option for samplers using a 0.01 inch tip rain gauge. See Dry Period Option, described on page 5-26.)
70	<p>START "STORM" AFTER A 1 MINUTE DELAY (1-999)</p>	Enter 1.
71	<p>PROGRAMMING COMPLETE RUN THIS PROGRAM NOW? YES NO</p>	Select NO.

The above example presented several screens that are not available in standard programming. Descriptions of features available in extended programming follow.

## 5.6 Suction Head

### Extended Screen for Suction Head Settings

AUTO SUCTION HEAD  
ENTER HEAD

If you choose AUTO SUCTION HEAD, the head will be determined for you. If you select ENTER HEAD, the screen below will be displayed so you can enter the suction head.

SUCTION HEAD OF  
ft  
(min - max)

Suction head is the vertical distance between the surface of the liquid source and the sampler's pump. At each sample event, the sampler determines the suction head automatically.

In extended programming, you can manually enter the suction head if you want. Select ENTER HEAD only when the head remains stable and you can measure it accurately.

## 5.7 Rinses and Retries

### Screens for Line Rinses and Sampling Retries

\_\_RINSE CYCLES  
(0-3)

RETRY UP TO \_\_ TIMES  
WHEN SAMPLING  
(0-3)

Rinses and retries are extended programming features. You can program the sampler to rinse the suction line automatically. During a line rinse cycle, the sampler draws liquid through the line to the liquid detector. As soon as it detects liquid, the sampler reverses the pump to purge the line.

The sampling retries feature lets you set the number of times, from 0 to 3, that the sampler tries to detect liquid in the line before skipping the sample.

## 5.8 Pacing

### Extended Pacing Screen

UNIFORM TIME PACE  
FLOW PACED  
EVENT PACED  
NONUNIFORM TIME

Sample pacing is the rate at which the sampler takes samples. Depending on the type of pacing you select, the rate is controlled by the sampler's internal clock or by inputs received from connected instruments.

Standard programming provides time pacing and flow pacing, which are described in Section 4. Extended programming provides additional pacing types, so its pacing screen (see example in margin) has four items listed instead of two.

"Uniform time" pacing is identical to "time" pacing in standard programming. "Flow paced" is the same for both types of programming. Event paced and nonuniform time pacing are described below.

### 5.8.1 Event Pacing

To program the sampler for event pacing, select event paced. Refer to Table 5-3 for an example of event paced sampling that uses three event conditions.

Up to fourteen event conditions can be defined (for two-part programs, up to fourteen event conditions can be defined for each part). An event will occur when any of the programmed event



conditions becomes true. The default distribution setting for event-paced sampling is sequential (each time an event occurs, the sampler takes one sample, placing it in one bottle). However, any distribution setting may be used.

If you have programmed multiple conditions, and more than one condition comes true at the same time (within your measurement interval), one sample will be taken and all conditions that caused the event will be noted on reports.

Table 5-3 uses **rate of change** for the event condition (see step 7). This feature enables the event condition under specific circumstances.

In the example below, a rate of change is set so that if the level rises more than one foot in a two hour time period, the event condition would be enabled and a sample taken.

In determining if the rise occurs in this example, the sampler looks back at the previous two hour time period to see if there is a rise of more than one foot between any valley (low point) or peak (high point) within that time period.

Once the condition becomes true (a rise of more than one foot is noted), the event condition is enabled. It will not be enabled again unless the condition becomes false, and then true again, within the two hour time window.

In event pacing, up to three different rate of change event conditions can be programmed (for two-part programs, a total of six rate of change event conditions can be defined, three for each part).

### 5.8.2 Event Paced Sampling

This example uses a sampler with an attached 730 Bubbler Flow Module, Rain Gauge, and an SDI-12 sonde at address 5 with four parameters.

**Table 5-3 Event Paced Sampling**

1	UNIFORM TIME PACED FLOW PACED <b>EVENT PACED</b> NONUNIFORM TIME	Select EVENT PACED.
2	EVENT01: RAIN <b>LEVEL</b> FLOW TEMP5 pH5 SP_CO5 DO5 DONE	Select the parameters that will trigger the event. Use the arrow keys to move through the parameters. To define the first event for this example, select LEVEL.
3	"LEVEL" CONDITION: <b>SET POINT</b> RANGE RATE OF CHANGE	Choose SET POINT.
4	"LEVEL" SET POINT: <b>1.000 ft</b> ( 0.001 - 30.00)	Enter a set point of 1 foot.

**Table 5-3 Event Paced Sampling (Continued)**

5	ENABLED WHEN: ABOVE SET POINT BELOW SET POINT	Select ABOVE SET POINT.
6	EVENT02: RAIN LEVEL FLOW TEMP5 pH5 SP_CO5 DO5 DONE	Select LEVEL again.
7	"LEVEL" CONDITION: SET POINT RANGE RATE OF CHANGE	Choose RATE OF CHANGE.
8	CONDITION IS TRUE WHEN "LEVEL" RISES FALLS	Choose RISES. This will enable the event condition if a rise occurs within the time frame and above the amount specified in screen #9.
9	"LEVEL" RISES 1.000 ft __ HOURS, __ MINUTES	Enter 1 ft and press ↵. Then enter 2 hours.
10	EVENT03: RAIN LEVEL FLOW TEMP5 pH5 SP_CO5 DO5 DONE	Select pH.
11	"pH5" CONDITION: SET POINT RANGE RATE OF CHANGE	Select RANGE.
12	"pHx" RANGE: LOWER: 4.00 UPPER: 10.00 ( 0.00 - 14.00)	Enter 4 for the lower range and 10 for the upper range.
13	ENABLED WHEN: INSIDE RANGE OUTSIDE RANGE	Choose INSIDE RANGE.
14	EVENT04: RAIN LEVEL FLOW TEMP5 pH5 SP_CO5 DO5 DONE	You will not be entering a fourth event condition, so use the arrow keys to scroll down, and then select DONE.
15	PACING: EVENT PACED 3 EVENT CONDITIONS	Proceed with the rest of the programming steps.

### 5.8.3 Nonuniform Time Pacing

The extended time pacing options are uniform time and non-uniform time. “Uniform time” pacing is identical to “time” pacing in standard programming. Nonuniform time pacing uses an irregular interval between sample events; each interval is individually programmable. There are three types of nonuniform time pacing:

- Nonuniform clock time pacing.
- Nonuniform interval pacing.
- Random interval pacing.

### 5.8.4 Nonuniform Clock Time Pacing

For clock time pacing, enter specific times for each sample event (see screen 2). You can enter as many as 99 clock times, but the interval between times cannot be greater than 24 hours. (Remember to use a 24-hour clock when entering times.) The sampler takes a sample at the start time.

### 5.8.5 Nonuniform Interval Pacing

For nonuniform interval pacing, enter the number of sample events spaced at intervals of minutes: 12 samples at 5 minute intervals, 6 samples at 10 minute intervals, and so on. The sampler accepts as many as 99 nonuniform interval entries. The sampler takes a sample at start time.

### 5.8.6 Random Interval Pacing

#### Time Pacing Screens

1

NONUNIFORM TIME:  
CLOCK TIMES  
INTERVALS IN MINUTES  
RANDOM INTERVALS

**CLOCK TIMES**

2

TAKE SAMPLES AT:  
1. START TIME  
2. HH:MM  
3. HH:MM

**INTERVALS IN MINUTES**

3

FIRST SAMPLE AT  
START TIME,  
THEN . . .

4

QUANTITY AT INTERVAL  
1. \_\_\_ AT \_\_\_ MIN  
2. \_\_\_ AT \_\_\_ MIN  
3. \_\_\_ AT \_\_\_ MIN

**RANDOM INTERVALS**

5

PROGRAM RUN TIME:  
\_\_\_ HOURS, \_\_\_ MINUTES

To program the sampler for random interval pacing, enter the length of time you want to sample. The run time is the only random programming setting you’ll need to enter because the sampler derives the number of sample events required for the program from the distribution settings. (You can combine random pacing with any distribution.) Each time you run the program, the sampler generates a new set of random intervals. This makes each sample event unpredictable from run to run.

In both nonuniform clock time pacing and nonuniform interval pacing, the sampler takes a sample at the start time. For random pacing, however, it takes the first sample at the end of the first interval, not at the start time.

## 5.9 Distribution

Distribution describes how the sampler is to deposit samples. A sample is the volume of liquid deposited in a bottle. A sample event includes the full sampling cycle and may deposit a sample into more than one bottle. You can program the sampler for five distribution methods:

- Sequential
- Bottles per sample
- Samples per bottle
- Composite
- Multiple Bottle Compositing

### 5.9.1 Sequential

In sequential distribution, the sampler deposits one sample in each bottle. A sequential sample represents a “snapshot” of the flow stream at a point in time.

### 5.9.2 Bottles Per Sample

In bottles per sample distribution, the sampler deposits a sample in each of a set of bottles. A bottle set includes at least two bottles but may include all bottles. Use bottles per sample when the volume to be collected is larger than the amount one bottle can hold or when you need identical samples.

### 5.9.3 Samples Per Bottle

In samples per bottle distribution, the sampler deposits samples from several sample events in a single bottle before moving to the next bottle. Use samples per bottle distribution to collect a series of small composite samples.

### 5.9.4 Composite

For single bottle configurations, samples per bottle distribution is known as composite sampling. A composite sample represents an average of the flow stream’s characteristics during the sampling period.

### 5.9.5 Multiple Bottle Compositing

Multiple bottle compositing is a combination of bottles-per-sample and samples-per-bottle. At each sample event, the sampler deposits a sample into a set of bottles. It moves to a new bottle set only after each bottle of the first set contains the programmed number of samples. Use multiple-bottle compositing to collect identical sets of composite samples or a composite sample that is larger than the capacity of a single bottle. Multiple bottle compositing is available only in extended programming.

### 5.9.6 Time Switching

In extended programming, the sampler offers an additional distribution feature, time switching. This feature determines when the sampler fills the next bottle or bottle set, and may be used with time-paced or flow-paced sample programs. Time switching distribution occurs at regular intervals (as programmed in screen 3 in the margin). The switch times are relative to the programmed “FIRST SWITCH TIME” (screen 4).

Switch times occur regardless of the state of the sampler. Be aware that the sampler may leave empty bottles if it becomes disabled. Pause and resumes are an exception; the sampler will not switch bottles during a pause if the current bottle is empty.

### Time Switched Distribution

1

2 BOTTLES PER  
SAMPLE EVENT (1-max)

- Enter the number of bottles that should receive samples at each sample event.

2

SWITCH BOTTLES ON:  
NUMBER OF SAMPLES  
TIME

- Select TIME.

3

SWITCH BOTTLES EVERY  
\_\_ HOURS, \_\_ MINUTES

- Enter the time between bottle switches.

4

FIRST SWITCH TIME  
AT: \_\_:\_\_

- Enter the first bottle switch time.

If the program settings instruct the sampler to take a sample at the start time, the sampler also draws a sample at the switch time. When this occurs, the pacing will also be reset at the switch time.

Time switching is normally used with flow-paced programs that do not take a sample at start. These programs will place a sample in the current bottle if it is empty at the switch time, and then move to the next bottle/set. Pacing intervals are reset at every switch time.

When you use the time switching feature, the volume in each bottle or bottle set may vary. Sample volumes that would exceed the bottle capacity are not taken and a “PROBABLE OVERFILL” message is logged.

### 5.9.7 Continuous Sampling

Sample programs can be run indefinitely by selecting “YES” at the “RUN CONTINUOUSLY?” screen. Continuous sampling resets the distribution when the distribution sequence is complete. That is, when the last bottle/set is reached, the next bottle/set is the first bottle/set. All pacing modes except RANDOM are supported.

When running a program continuously, the bottles must be serviced at regular intervals to prevent overfilling the bottles. The sampler assumes that the next bottle/set is empty and ready to receive samples. If you are using this feature with two-part programming, keep in mind that the parts will most likely reset at different intervals.

**Sequential**

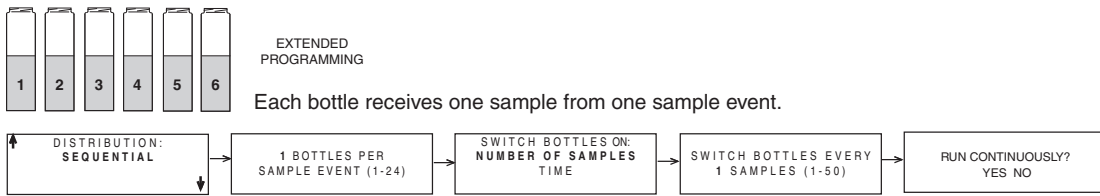

**Bottles-per-Sample**

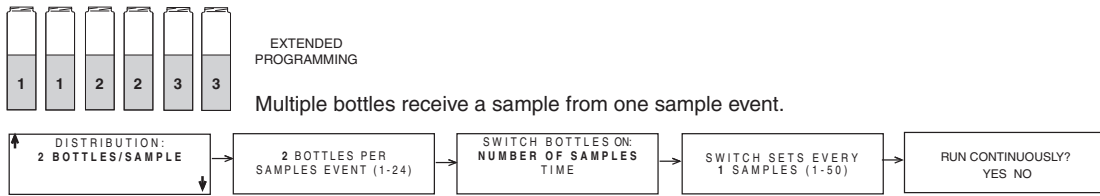

**Samples-per-Bottle**

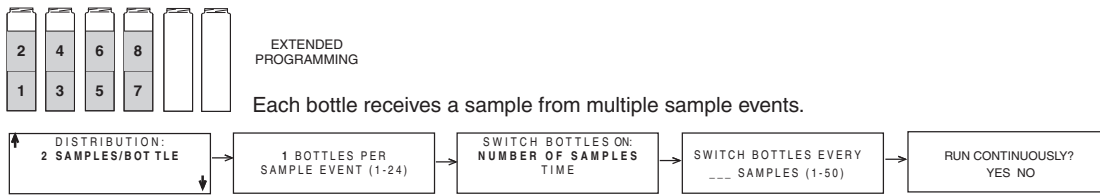

**Multiple Bottle Compositing**

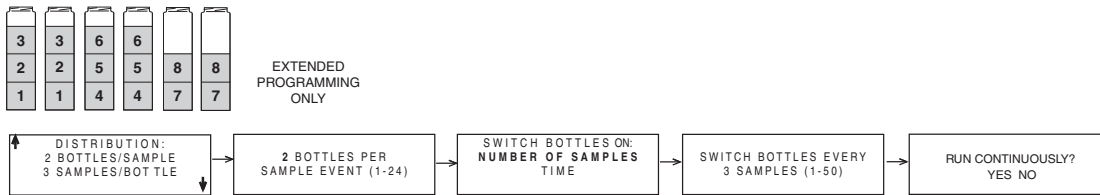

**Time Switched (Flow-paced, No sample at start)**

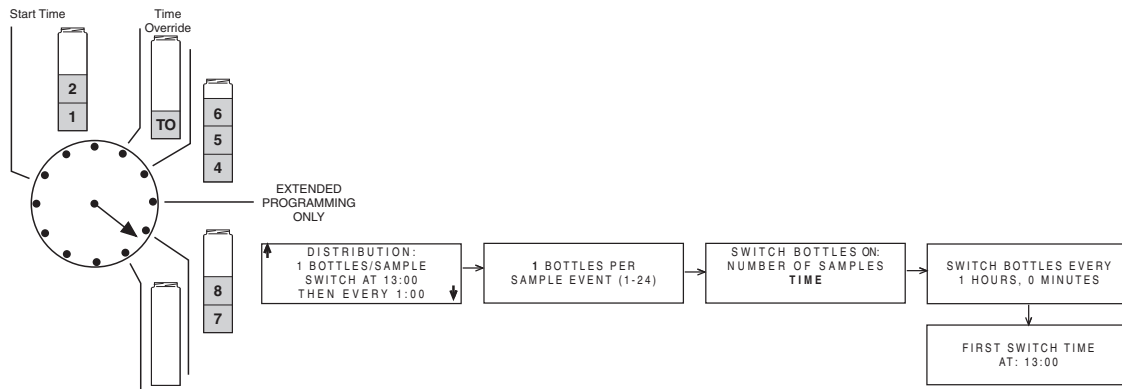

Figure 5-1 Sample Distribution

## 5.10 Flow Proportional Sample Volumes

The 6712 can collect flow proportional sample volumes. For some sampling protocols, these flow-weighted, variable-volume samples can be more representative of the stream. This is because stream characteristics often change as the flow fluctuates.

Variable-volume sampling is possible when the sampler is programmed for Uniform Time pacing. To enable this feature, select YES at the display asking “DO YOU WANT SAMPLE VOLUMES DEPENDENT ON FLOW?”

```
DO YOU WANT
SAMPLE VOLUMES
DEPENDENT ON FLOW?
YES      NO
```

After answering YES, the sampler displays screens to program the flow proportional volumes. If the sampler has a 700 Series Flow Module inserted, you will be asked which flow measurement should be used to determine the volumes.

```
FLOW PULSES
FLOW MODULE VOLUME
```

To base the volumes on an external flow measurement device attached to the Flow Meter connector, select FLOW PULSES. To base the volumes on the 700 Series Flow Module readings, select FLOW MODULE VOLUME.

Next, the sampler asks for the SAMPLE VOLUME to collect at each time interval. This volume is expressed as 10 ml for every X number of pulses, or if using a flow module, for every volume unit.

```
SAMPLE VOLUME:
10 ml FOR EVERY
___ PULSES
```

Refer to section 5.10.1, *Calculating Variable Sample Volume Settings*, for a more detailed discussion on this setting.

The final screen used to program variable-volume sampling is the MINIMUM SAMPLE VOLUME. If the number of flow pulses or flow module volume is not sufficient enough to collect this minimum volume, the sample is skipped and the flow count carries over to the next sample time. This setting ranges from 10 ml to a maximum determined by the bottle volume.

```
MINIMUM
SAMPLE VOLUME
___ ml
(10 - maximum)
```

### 5.10.1 Calculating Variable Sample Volume Settings

The entry for the SAMPLE VOLUME display can be calculated based on expected flow rates and collection volume requirements. The number of pulses or flow module volume that you enter should ensure that the minimum volume of liquid required for analysis is collected without exceeding the bottle volume capacity of the sampler. You may find it helpful to determine a range of values by calculating both possibilities. The number you enter would be selected from this range. This range is illustrated in Figure 5-2.

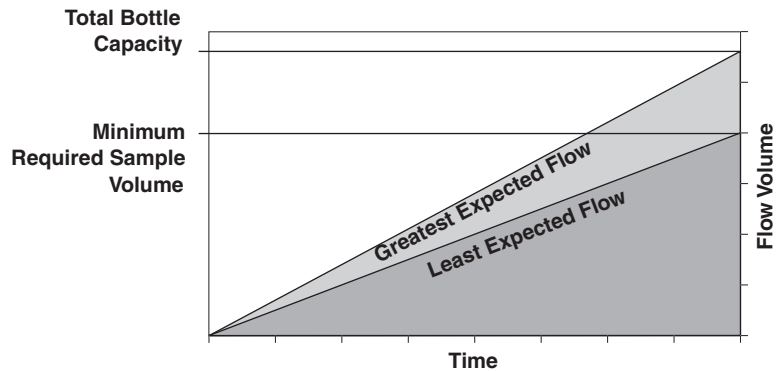

Figure 5-2 Factors Affecting Flow-Weighted Variable-Volume Samples

In other words, at the greatest expected flow, this SAMPLE VOLUME value should be set to prevent filling the bottle before the end of the program. An early full-bottle condition would result in a composite sample that is not representative of the flow stream.

At the lowest expected flow, the SAMPLE VOLUME value should be set to ensure that enough sample is collected. If too little sample liquid is collected, there may not be enough for analysis although it is a representative composite sample.

For example, consider an NPDES sampling program used to collect a flow-proportional composite sample for BOD, TSS, and  $\text{NH}_3\text{-N}$  analysis. The laboratory requires at least 1,000 ml for BOD, 100 ml for TSS, and 400 ml for  $\text{NH}_3\text{-N}$  tests. The minimum composite volume needed for analysis is then 1,500 ml, but to allow for duplicates and spillage, this volume is doubled to 3,000 ml. The samples are to be collected over an eight hour period at 15 minute intervals into a 9,400 ml composite bottle. Flow rates at the site range from 1.5 to 2.0 mgd, the equivalent volume of 500,000 and 666,667 gallons respectively over the eight hour period. This flow is measured by an external flow meter that sends a flow pulse every 100 gallons. Figure 5-3 depicts this scenario.



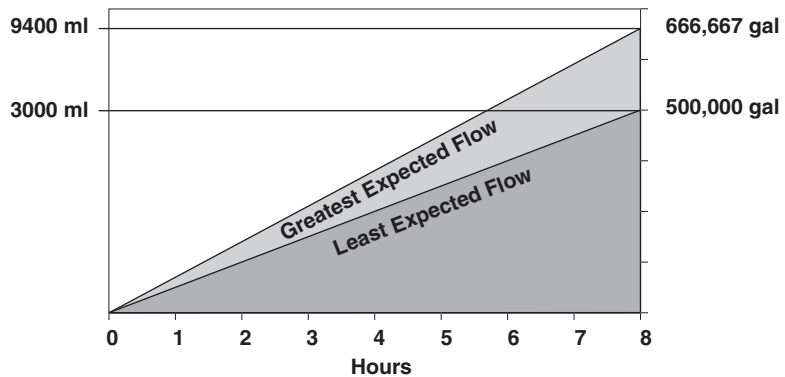

Figure 5-3 Variable-Volume Scenario

### 5.10.2 Calculations when Using an External Flow Meter

SAMPLE VOLUME:  
10 ml FOR EVERY  
\_\_\_ PULSES

The highest possible SAMPLE VOLUME value is determined by the minimum volume required for analysis and the least expected flow rate over the sampling duration. To calculate the number of pulses at this high end of the range, you should know:

- the least expected flow volume that will pass the flow measurement point
- the flow volume interval between each flow pulse from the external flow meter
- the minimum composite sample volume required for analysis. Allow for duplicates and spillage.

These factors would be applied to the following equation.

$$10 \text{ ml for every } \_ \text{ pulses} = \frac{(\text{Least Total Flow Vol}) / (\text{Flow Pulse Vol})}{(\text{Minimum Required Vol}) / (10 \text{ ml per unit})}$$

From the scenario we can apply the factors for the equation.

$$10 \text{ ml for every } 16.7 \text{ pulses} = \frac{(500,000 \text{ gallons}) / (100 \text{ gallons per pulse})}{(3,000 \text{ ml} / 10 \text{ ml})}$$

Because the SAMPLE VOLUME entry must be in whole numbers, 16.7 is rounded down to 16. It is important to note that this number is inversely proportional to the amount of volume collected. Rounding up would result in less volume collected.

The lowest possible SAMPLE VOLUME value is dependent upon the highest expected flow and the available bottle volume. To calculate the number of pulses or volume at this low end, you should know:

- the greatest expected flow volume that will pass the flow measurement point
- the flow volume interval between each flow pulse from an external flow meter
- the available bottle volume for sample collection.

These factors would be applied to the following equation.

$$10 \text{ ml for every } \_ \text{ pulses} = \frac{(\text{Greatest Total Flow Vol}) / (\text{Flow Pulse Vol})}{(\text{Total Bottle Vol}) / (10 \text{ ml per unit})}$$

From the scenario we can apply the factors to the equation.

$$10 \text{ ml for every } 7.0 \text{ pulses} = \frac{(666,667 \text{ gallons} / 100 \text{ gallons})}{(9,400 \text{ ml} / 10 \text{ ml})}$$

At high flow rates, a number below 7 would overflow the bottle. At low flow rates, a number greater than 16 would collect too little sample. Therefore, a value should be selected between 7 and 16 pulses.

### 5.10.3 Calculations when Using a 700 Series Flow Module

The same principles discussed in Section 5.10.2 apply. However, the equations differ slightly because the flow module directly measures the stream's flow volumes. The equation for the high end of the range is:

$$10 \text{ ml for every } \_ \text{ units} = \frac{(\text{Least Total Flow Vol})}{(\text{Minimum Required Vol}) / (10 \text{ ml per unit})}$$

Using the same scenario the calculations would be:

$$10 \text{ ml for every } 1667 \text{ gallons} = \frac{500,000 \text{ gallons}}{(3,000 \text{ ml}) / (10 \text{ ml per gallon})}$$

SAMPLE VOLUME:  
 10 ml FOR EVERY  
 \\_ Gallons

The equation for the low end of the range is:

$$10 \text{ ml for every } \_ \text{ units} = \frac{(\text{Greatest Total Flow Vol})}{(\text{Total Bottle Vol}) / (10 \text{ ml per unit})}$$

The scenario would be applied as:

$$10 \text{ ml for every } 709 \text{ gallons} = \frac{666,667 \text{ gallons}}{(9400 \text{ ml}) / (10 \text{ ml per unit})}$$

Therefore, a value should be selected between 709 and 1667 gallons for the given scenario.

## 5.11 Sampler Enable

Certain external instruments can enable (start) or disable (stop) a sampler by sending a signal to pin F of the sampler's flow meter connector. Isco flow meters, flow loggers, and the Isco 1640 Liquid Level Actuator have a programmable sampler-enable feature that lets them enable or disable the sampler. You can define the condition (such as level, flow rate, pH, temperature, percent, rainfall, and I/O) or combination of conditions that need to be true in order to enable the sampler. Refer to Figure A-12 in Appendix A for details on programming sampler enables.

When the sampler detects that it is disabled at start time, it suspends the program until it is enabled. Once enabled, the sampler collects a sample only when programmed to take a sample at the enable time. The diagram in Figure 5-4 shows the sampler's response when enabled or disabled at the start time.

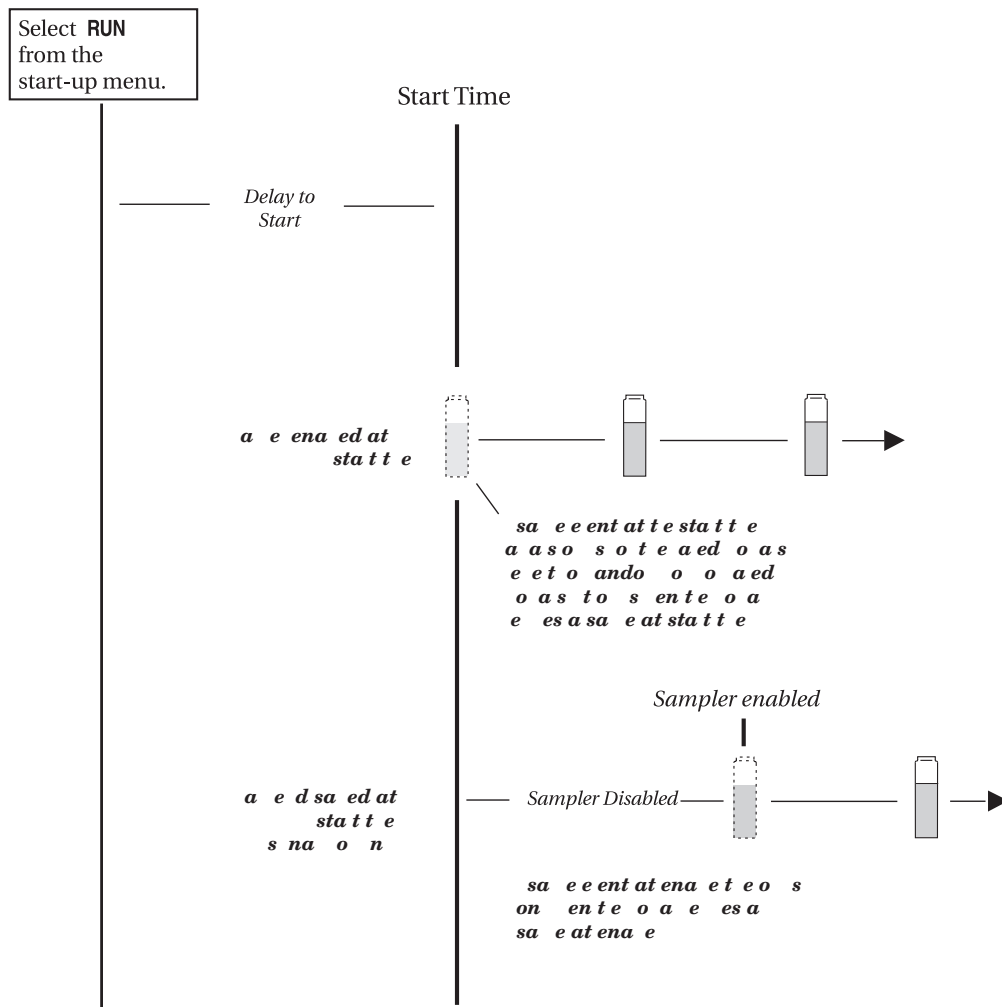

Figure 5-4 Start Time Diagram for Sampler Enable Settings

### 5.11.1 Sampler Enable

This example uses a sampler with an attached 730 Bubbler Flow Module, Rain Gauge and an SDI-12 sonde at address 5 with four parameters.

**Table 5-4 Sampler Enable**

1	ENABLE: NONE PROGRAMMED	In this example, you will be enabling the sampler if it rains .5” in 2 hours and the level goes above 1 foot.
2	ENABLE: <b>RAIN</b> LEVEL FLOW TEMP5 pH5 SP_CO5 DO5 NONE	Select RAIN.
3	ENABLE: RAIN <b>AND</b> OR DONE	Choose AND.
4	ENABLE: RAIN AND <b>LEVEL</b> FLOW TEMP5 pH5 SP_CO5 DO5 DONE	Select LEVEL.
5	“RAIN” SET POINT: .5 INCHES PER __HOURS, __MINUTES	Enter .5 for the inches of rain. Press ↵ . Enter 2 HOURS.
6	ENABLED WHEN: <b>ABOVE SET POINT</b> BELOW SET POINT	Select ABOVE SET POINT.
7	RESET RAIN HISTORY? <b>YES</b> NO	Select YES.
8	“LEVEL” CONDITION <b>SET POINT</b> RANGE RATE OF CHANGE	Select SET POINT.
9	“LEVEL” SET POINT: +1 ft ( 0.001 - 30.00)	Enter 1 foot.
10	ENABLED WHEN: <b>ABOVE SET POINT</b> BELOW SET POINT	Select ABOVE SET POINT.
11	ENABLE: RAIN >0.50” / 2:00 AND LEVEL >1.000 ft	Your enable conditions will be summarized on the display. If correct, press ↵ to continue. If necessary, make changes to the enable conditions.

## 5.12 Sampler Enable Responses

In addition to programming enable conditions, extended programming lets you control the sampler's response to its enable state. You can:

- Stay enabled after the first enable.
- Set up a repeatable enable.
- Take a sample at enable or disable.
- Delay the start of sampling after the enable.
- Reset the sampling interval countdown each time the sampler is enabled.
- Control the sampling interval countdown while disabled.
- Enable Part B of a two-part program when Part A is done.

### 5.12.1 Once Enabled Stay Enabled

For certain monitoring programs, you may want the sampler to continue to sample, even though the conditions that enabled the sampler no longer exist. When you use the ONCE ENABLED, STAY ENABLED feature, after becoming enabled the sampler takes samples until it reaches the end of its program.

ONCE ENABLED,  
STAY ENABLED?  
YES NO

#### **Note**

The STAY ENABLED feature works only when the sampler becomes enabled following program start. If you need this feature with enable *prior* to program start, contact Teledyne Isco for details.

### 5.12.2 Repeatable Enable

After enabling the sampler, the enabling instrument (or instruments) continues to monitor the conditions and disables the sampler when the conditions are no longer satisfied. If re-enabled, the sampler resumes the sampling program.

#### **Note**

Repeatable enable is called "sampler latching" in flow meters, flow loggers, and FLOWLINK. Latching a sampler produces the same results as selecting YES; the difference is that the external instrument controls the latching.

### 5.12.3 Sample at Enable or Disable

You have the option of directing the sampler to take a sample as soon as it receives the enable and/or disable signal. If you program the sampler to stay enabled and choose to take a sample at enable, the sample interval will be reset at the enable time. Samples at disable do not affect the sample intervals. Standard programs do not take a sample at the enable time.

SAMPLE AT ENABLE?  
YES NO

#### 5.12.4 Delay To Start Of Sampling

If you have selected ONCE ENABLED STAY ENABLED and have chosen to not sample at the enable, you have the opportunity to suspend the start of sampling. This choice is useful for storm programs that require a flow-paced sample taken after the initial grab sample.

```
START SAMPLING
AFTER A
___ MINUTE DELAY
(1-999)
```

#### 5.12.5 "Dry Period" Option

For samplers used with a 0.01 inch tip rain gauge, you can cause the sampler to wait for a "dry" period of under 0.10 inches of rain over a 72-hour period before running the program. At RUN time, the sampler asks if you want to restart the 72-hour period. Select this choice if you want the sampler to disregard any "dry" period that took place prior to the program start. The sampler will wait for up to one year for the "dry" period to occur.

```
START "EXTENDED 1"
AFTER A 72 HOUR
"DRY" PERIOD?
YES NO
```

#### 5.12.6 Resetting the Sample Interval at Enable

```
RESET SAMPLE
INTERVAL AT ENABLE?
YES NO
```

If you answer "NO" to the above screen, you will see:

```
CONTINUE COUNTDOWN
WHILE DISABLED?
YES NO
```

You may want the pacing countdown to start over each time the sampler becomes enabled. To accomplish this, select "YES" when asked if you want to reset the sample interval at enable. The next sample event will occur at the end of a full interval. Furthermore, if the sampler is enabled several times during the program, it resets the countdown each time.

Use the reset-interval feature carefully. For example, avoid resetting the interval when you sample with uniform-time pacing and want to take samples at specific times.

The effects of resetting the interval can be seen in this example: A sampler has been programmed to sample every 15 minutes and to reset the interval when enabled. It receives an enable signal at 10:03 and takes a sample. After resetting the interval, the sampler takes subsequent samples at 10:18 (not 10:15), 10:33 (not 10:30), and so on.

If you select "NO" when asked if you want to reset the sample interval at enable, you will be asked if you want to continue the countdown while disabled. You can have the sampler continue the countdown, repeating it as often as necessary while the sampler is disabled, or you may suspend the countdown while disabled, resuming the countdown as the sampler is enabled. The standard program allows the countdown to continue while disabled.

## 5.13 Pauses/Resumes

### Pause and Resume Screens

Flowcharts containing the pause and resume screen appear in Appendix A.

PAUSE	RESUME
1. 17:00 MO	08:00 TU
2. 17:00 TU	08:00 WE
CLEAR	DONE

SAMPLE AT RESUME?
YES NO

Pause and resume settings, available in extended programming, create an intermittent sampling schedule. A program with pauses and resumes begins sampling at its programmed start time, continuing until the first pause time and day of the week. It then suspends sampling until the first resume time, when it begins sampling again. If the start time falls within a pause period, the sampler will not begin sampling until the next resume time. Pauses and resumes repeat weekly.

You can enter up to nine pairs of pause and resume times. The pause and resume times shown as examples to the left suspend the program between 5:00 p.m. Monday and 8:00 a.m. on Tuesday and between 5:00 p.m. Tuesday and 8:00 a.m. on Wednesday. If the start time is Monday at 8:00 a.m., the sampler takes samples between 8:00 a.m. and 5:00 p.m. Monday; between 8:00 a.m. and 5:00 p.m. Tuesday; and, continues after 8:00 a.m. Wednesday. To remove pause and resume settings from a program, select CLEAR.

A sampler running a pause/resume program resets the pacing interval at each resume time. You can program the sampler to take a sample at resume times (see screen at left).

## 5.14 Running Programs

To run an extended program, select run from the main menu. You may also select YES at the RUN THIS PROGRAM NOW? screen at the end of the programming screens.

Extended programs scheduled to start at a clock time will not start until the programmed clock time on or after the *first valid date*.

Note that if you have recently calibrated a parameter probe, the sampler may delay the start and display "PLEASE WAIT" until valid readings are expected from the probe. The delay accounts for the time typically required to install the probe, and lasts for five minutes after you complete the calibration.

### 5.14.1 Run Time Screens

Run time screens, which report the program's status while running a program, are explained in Section 4.

### 5.14.2 Interrupting a Running Program

Interrupting a running program is also explained in Section 4. The scrolling menu that appears during the manual paused state can have two extra options when using extended programming:

**Adjust Enable** – This option is available for extended sampling programs that have programmed enable conditions. Selecting this option allows you to change the set-points or ranges for the enable conditions. The sampler displays all of the programming screens that define the thresholds of the programmed enables. You cannot change the type of enables used or the way they are combined.

If rain is an enabling condition, you also have the option of resetting the rain history.

**Adjust Suction Head** – If you have chosen to manually enter the suction head, and are in the manual paused state, the scrolling menu will have an option to adjust the suction head. If you make changes to the suction head value, the sampler logs a changed suction head event.

## 5.15 Sampling Reports

The 6712FR records a variety of data while running a sampling program. Sample reports can be found in Section 4.

Section 4, Table 4-3 contains a list of source codes and program events that may be recorded when using either standard or extended programming.

## 5.16 Other Functions

### Other Functions Menu

```
RUN "PROGRAM NAME"  
PROGRAM  
VIEW REPORT  
OTHER FUNCTIONS
```

- Select OTHER FUNCTIONS.

```
MAINTENANCE  
MANUAL FUNCTIONS  
SOFTWARE OPTIONS  
HARDWARE
```

In extended programming, the “Other Functions” menu screen includes options for:

- Maintenance (see Section 7)
- Manual Functions (see Section 4)
- Software Options.
- Hardware

## 5.17 Software Options

The software option screens allow you to set up a number of different software options:

- Liquid Detector Enable
- Normal/Quick View Screens
- Measurement Interval
- Dual Sampler Mode
- Full Bottle Detection
- Display Backlighting
- Event Marks
- Pump Purge Counts
- Serial Output
- Remote Access
- Interrogator Connect Power

### 5.17.1 Liquid Detector Enable/Disable

```
USE LIQUID DETECTOR?  
YES NO
```

Under some conditions (pressurized lines, sampling foam), a more repeatable sample volume may be delivered by disabling the liquid detector. Selecting NO will turn the Liquid Detector off.

If the Liquid Detector is off:

- you must enter the SUCTION HEAD
- no RINSES or RETRIES will be available
- you will not be able to CALIBRATE SAMPLE volumes
- the RESULTS report will read a COUNT TO LIQUID of 0
- A complete purge will occur between samples when using multiple bottles-per-sample distribution.



### 5.17.2 Programming Style

The sampler has two different styles of programming screens: normal and quick view. These are both explained in Section 3.

When you are in extended programming, the default style is Quick View, which allows you to move more quickly through the screens.

If you prefer a step-by-step display for the screens, switch to the Normal setting.

### 5.17.3 Measurement Interval

MEASUREMENT INTERVAL 5 15 30 SECONDS 1 2 5 MINUTES STORAGE INTERVAL
--

If using a 700 Series module or SDI-12 Sonde parameter for enabling, the sampler will request a Measurement Interval. The Measurement Interval allows the sampler to compare the parameter to the enabling conditions at a rate faster than the Data Storage interval. If the Measurement Interval is equal to or greater than the Data Storage interval, the parameter will be checked at the rate of Data Storage interval.

Normally, there are two considerations when selecting the Measurement Interval: power consumption and duration of the enabling event. This setting for battery powered samplers will require some degree of balance between the need to conserve power yet detect the enabling event before it has passed.

### 5.17.4 Dual Sampler Mode

#### Dual Sampler Mode

DUAL SAMPLER MODE? YES NO
------------------------------

- Select YES to put the sampler in the dual sampler mode. When you no longer need dual samplers, return to this screen to turn the feature off.

Dual Sampler Mode lets you operate two samplers as a pair. The primary sampler disables the secondary one until the primary sampler completes its sampling program. The samplers then reverse roles with the second sampler becoming the primary one.

#### Setting Up Dual Samplers –

1. Turn on the dual sampler mode in both samplers.
2. Install the samplers.
3. Connect the samplers with the Dual Sampler Mode Interconnect Cable by attaching the cable to the sampler's flow-meter connectors. If your installation includes a flow meter or flow logger, use the Dual Sampler Mode to Flow Meter Cable instead.
4. Decide which sampler is to be the primary sampler; the primary sampler should be the sampler with the program you want to run first.
5. Turn the primary sampler on and run its sampling program by selecting RUN. After at least 5 seconds, turn the secondary sampler on and select RUN from its main menu.

**How Does It Work? –** The primary sampler sends a disable signal out its flow meter connector. The secondary sampler receiving the signal is held disabled until the primary sampler completes its program.

When using a flow meter or flow logger a Dual Sampler Mode to Flow Meter cable must be used. This cable is constructed so that the pacing instrument receives only the event marks. Therefore, a connected flow meter will not receive a bottle number signal, nor will it be able to control the sampler inhibit.

### Bottle Full Detect

BOTTLE FULL DETECT?  
YES NO

**Bottle Full Detection** – The sampler can detect a full bottle condition when collecting samples in a single bottle (composite sampling). When the sampler detects a full bottle, it stops the sampling routine.

A BOTTLE FULL condition will also stop a sampling routine that is set to RUN CONTINUOUSLY.

The Bottle Full Detect screen allows you to enable or disable this feature. Selecting “YES” enables the sampler to detect a full bottle and stop the sampling routine. Selecting “NO” disables this feature. The Bottle Full Detect setting is part of the sampling program. Because it is a program setting, full bottle detection can be enabled or disabled for each of the four extended programs. If the Bottle Full Detect setting is critical to your sampling program, always check this Software setting after you select a different Extended Program.

This feature relies on a post-purge after each sample. When using the Bottle Full Detect, make sure that post-sample purges greater than 100 are used.

Bottle Full Detect is always disabled in the Standard Programming mode.

### Adjusting the Display Backlighting

BACKLIGHT ALWAYS OFF  
TIMED BACKLIGHT  
CONTINUOUS BACKLIGHT

**Display Backlighting** – The display has a backlight that is adjustable so that the backlight is always off, timed or always on.

In the timed backlight mode the sampler turns the backlight off after detecting no key strokes within 60 seconds. Any keystroke (except ON-OFF) turns the backlighting on again. In this mode the backlight must be on before the sampler accepts a menu choice or number entry. If you press a key and a screen does not respond, it is because the keystroke turned the backlight on.

It is recommended that you use either BACKLIGHT ALWAYS OFF or TIMED BACKLIGHT when using a battery.

### Event Marks

EVENT MARK SENT FOR:  
EVERY SAMPLE  
COMPLETE SAMPLES

**Event Marks** – The sampler generates an event mark at each sample event, sending it through the flow meter connector to a connected instrument. The event mark may also control an external device; a connected solenoid relay, for example. When using the event mark for a data logger or to control external devices, you may need to adjust the mark by changing the factory settings.

The event mark is adjustable through the software setup screens. You can set up the sampler to generate an event mark for EVERY SAMPLE or for COMPLETE SAMPLES.

If you select COMPLETE SAMPLES, the sampler sends a three-second pulse only after it successfully collects a sample. The sampler will not send an event mark if an error occurs, such as “No Liquid Detected.”

If you select EVERY SAMPLE, the sampler will send an event mark every time a sample is initiated. The event mark signal can be a:

- 3-second pulse at the beginning of the pre-sample purge.

- 3-second pulse at the beginning of forward pumping only, marking the time the sampler deposited the sample.
- Variable duration pulse generated during the pump cycle, from the beginning of the pre-sample purge to the end of the postsample purge.
- Variable duration pulse generated only during forward pumping.

Figure 5-5 shows event mark timing diagrams.

**Bottle Number** – Concurrent with the event mark, the sampler also sends a bottle number signal. The bottle number signal is a series of pulses. The number of pulses sent represents the bottle currently accepting a sample (see Figure 5-5).

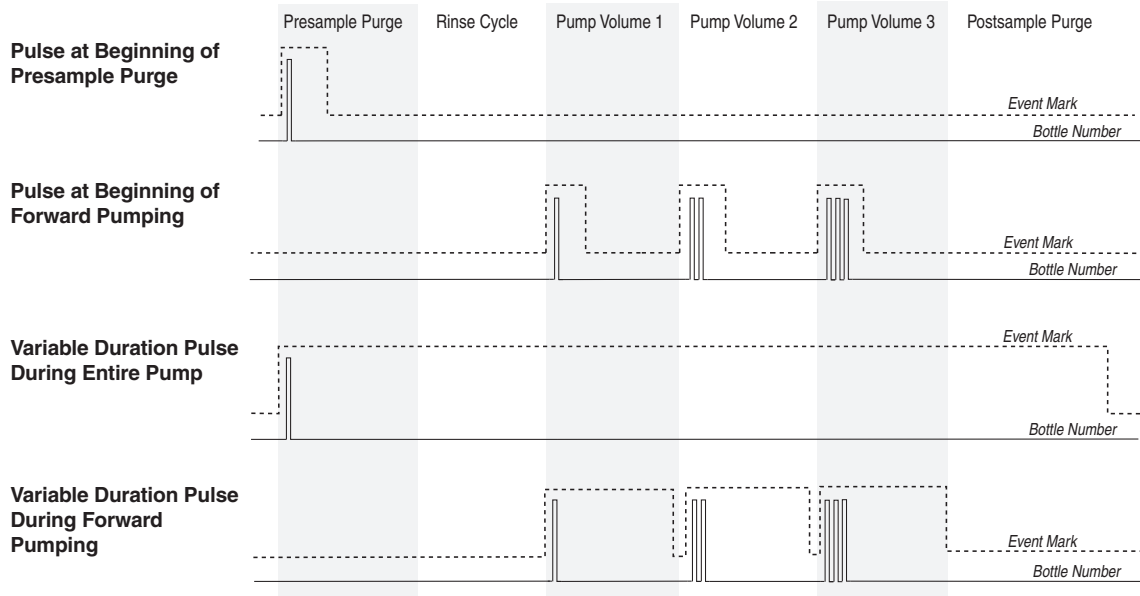

*This diagram shows the pulses sent for a bottles-per-sample distribution scheme*

*Figure 5-5 Event Mark Timing Diagram*

### 5.17.5 Pre-sample and Post-sample Purge Counts

PRE-SAMPLE PURGE:  
\_\_\_\_ COUNTS  
(10-9999)

POST-SAMPLE PURGE:  
DEPENDENT ON HEAD  
FIXED COUNT

POST-SAMPLE PURGE:  
\_\_\_\_ COUNTS  
(10-9999)

The pre-sample purge is when the pump runs in reverse clearing the strainer of any debris before taking a sample. The pre-sample purge is set at 200 pump counts. After the sample is taken a post-sample purge occurs to clear the liquid from the suction line. The duration of the post-sample purge is determined by the length of the suction line to maximize the battery life. The pre- and post-sample purge can also be manually set.

### 5.17.6 Serial Output

#### Programming the serial output

```
PERIODIC
SERIAL OUTPUT?
YES NO
```

```
PORT SETTINGS:
9600N81 4800N81
2400N81 1200N81
```

```
SERIAL OUTPUT EVERY:
15 SEC 1 MIN
5 MIN 15 MIN
```

Serial ASCII data can be output through the controller's interrogator port. The output frequency is user-selectable: every 15 seconds, every minute, every 5 minutes, every 15 minutes, or by command.

To receive serial data as a *periodic output*:

1. Select YES at screen asking if you want periodic serial output.
2. Select the appropriate baud rate setting in screen . Note that at all baud rates the data is sent with no parity, eight data bits, and one stop bit. If you have difficulty with the connection, try a slower baud rate.
3. Select the desired output interval in screen.
4. Connect to the 6712 controller's interrogator connector using a standard interrogator cable.

To receive serial data by *command*:

1. Select NO at the screen asking for periodic serial output .
2. Connect your computer to the 6712 controller's interrogator connector with a standard interrogator cable, P/N 60-2544-040 (25 pin) or 60-2544-044 (9 pin).
3. Configure your communications software for a baud rate no higher than 19,200 kb, no parity, 8 data bits, and 1 stop bit.
4. From the computer's keyboard, type "?" repeatedly until the 6712 controller determines the baud rate. Once the baud rate is known, the 6712 returns an identification banner. This banner indicates that the connection is working properly.
5. Type DATA<CR> each time the data string is desired.

The serial data is in comma-separated-value format. Only the values that the sampler is set up to measure will be output in the data string. The string is terminated with a <CR><LF>. To read the data in the string, refer to Table 5-5. This serial data can also be accessed from a remote location using the optional dial-out modem (see Section 7).

#### **Note**

The internal modem is disabled when an interrogator cable is connected to the sampler's Interrogator port. It cannot receive incoming calls, and the alarm dialout is rendered inoperative, while this cable is connected. **Disconnect the interrogator cable in order to use the 4200T modem.**

**Table 5-5 Serial Data Codes**

Identifier	Parameter	Units
B? <sup>1</sup>	Bottle number and time	days since 1-Jan 1900
CR	Current day's rain	tips (rolls over every 256 tips)
CS <sup>2</sup>	Checksum	unsigned long
DE	Description	6712 Sampler
FL	Flow	cubic meters per second
ID	Unit specific identifier	10 digit unsigned long
LE	Level	meters
MO	Model	6712
PE	Percent	percent of full scale
PH	pH	none
PR	Previous day's rain	tips (rolls over every 256 tips)
RA	Rain	tips (rolls over every 256 tips)
RTE	Refrigerator Temperature	degrees celsius
SS	Sampler enable state	logical
TE	Temperature	degrees celsius
TI	Current time	days since 1-Jan-1900
VE	Velocity	meters per second
VO	Volume	cubic meters
VSI	Velocity signal strength	percent
VSP	Velocity spectrum strength	percent
CO <sub>a</sub> <sup>3</sup>	Conductivity	milliseimens per centimeter
DO <sub>a</sub>	Dissolved oxygen	milligrams per liter
PH <sub>a</sub>	pH	none
SA <sub>a</sub>	Salinity	parts per thousand
SP <sub>a</sub>	Specific Conductance	milliseimens per centimeter
TD <sub>a</sub>	Total Dissolved Solids	grams per liter
TE <sub>a</sub>	Temperature	degrees Celsius
OR <sub>a</sub>	Oxidation reduction potential	millivolts
LE <sub>a</sub>	Level	meters
MM <sub>a</sub>	Ammonium-nitrogen	milligrams nitrogen per liter
MA <sub>a</sub>	Ammonia-nitrogen	milligrams nitrogen per liter
NI <sub>a</sub>	Nitrate-Nitrogen	milligrams nitrogen per liter
TB <sub>a</sub>	Turbidity	nephelometric turbidity units

**Table 5-5 Serial Data Codes (Continued)**

Identifier	Parameter	Units
CL <sub>a</sub>	Chloride	milligrams per liter
CP <sub>a</sub>	Chlorophyll	micrograms per liter
FL <sub>a</sub>	Flow rate	cubic meters per second
VO <sub>a</sub>	Flow volume	cubic meters
xxD <sub>a</sub> <sup>4</sup>	Other data not listed above	
<ul style="list-style-type: none"> <li>• The three most recent samples will have entries as B?. The “?” will be the first bottle number in the set. If the sample is a grab sample, it will be shown as B0.</li> <li>• An “a” in the identifier indicates an SDI-12 address.</li> <li>• “xx” matches the data label for the SDI-12 parameter.</li> <li>• The checksum does not include the checksum, carriage return, and linefeed.</li> <li>• The string is terminated with &lt;CR&gt;&lt;LF&gt;.</li> </ul>		

**5.17.7 Program Lock**

The specialized software option Program Lock (P/N 60-9003-532) may be purchased from Teledyne Isco.

Once activated, the purchased option is always available, even if the software is upgraded at a later time. **The option must be installed at the factory. Consult the factory for further details.**

To view which software options have been activated, select VIEW REPORT>SYSTEM IDs. A software options screen will list a code for each active option. The code for Program Lock is **1108**.

The Program Lock adds password security to the 6712 sampling programs. With this option activated, a user-selected password (up to five digits) must be entered before any program changes or run time modifications can be made. Run time modifications include accessing the Manual Pause menu options and shutting off the sampler. You will still be able to run the current program, view reports, and interrogate the sampler without the knowledge of the password.

If three consecutive attempts to enter the password fail, a five minute “time-out” will follow in which most keys are deactivated.

The user-selected password defaults to “6712” and may be changed in the Software options that are available in the Extended Program mode (see example at left). While the password may only be changed in the Extended Program mode, the program lock works for both Standard and Extended programs.

Should you forget your password, a key code can be obtained from Teledyne Isco’s Customer Support department for a nominal fee.

PROGRAM LOCK DISABLED

ENABLE PROGRAM LOCK?  
YES NO

CHANGE PASSWORD TO  
.....

REENTER NEW PASSWORD  
.....

From Standby

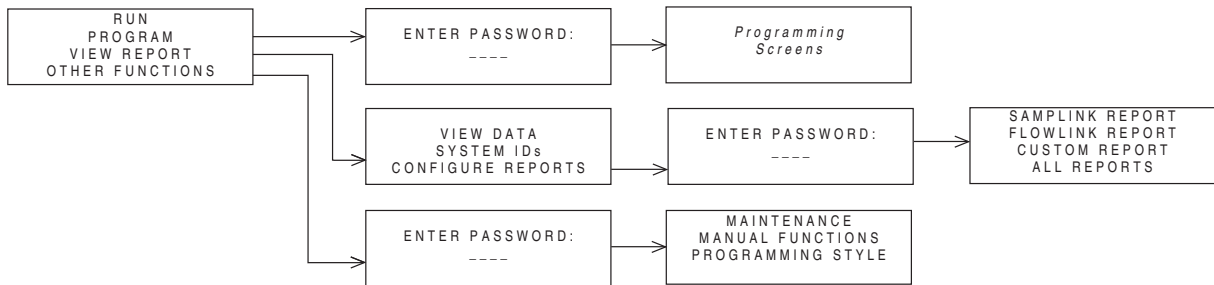

While Running a Program

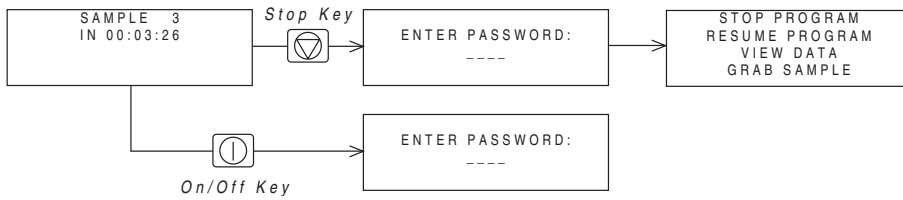

Figure 5-6 Password Protected Functions

## 5.18 Hardware Setup

RUN "PROGRAM NAME"  
PROGRAM  
VIEW REPORT  
OTHER FUNCTIONS

- Select Other Functions

MAINTENANCE  
MANUAL FUNCTIONS  
PROGRAMMING STYLE  
HARDWARE

- Select Hardware

The hardware setup screens make adjustments to the sampler's hardware-based features:

- SDI-12 Sonde Setup
- Rain Gauge Setup
- I/O Pin Programming
- Dialout Alarms
- Pager Numbers
- Text Messaging
- Refrigerator Temperature
- Analog Outputs

### 5.18.1 SDI-12 Sonde Setup

The 6712 supports SDI-12 sondes. For more information on setting up sondes, refer to Section 6.

### 5.18.2 Rain Gauge Setup

With standard programming, the sampler does not record rain gauge readings. However, with extended programming, recording the rain gauge readings and the rain enable option can be turned on or off. Enter the hardware setup and follow the screens to the left in the margin.

DO YOU HAVE A  
RAIN GAUGE CONNECTED?  
YES NO

- Select YES.

RAIN GAUGE:  
0.01 inch TIP  
0.1 mm TIP

- The rain gauges are set up to tip on either .01 inch or .1 mm. Select the desired tip.

When asked if you have a rain gauge connected, select YES to record the rain gauge readings and add RAIN as a sampler enable option. Select the appropriate tip for the rain gauge. The sampler will then create a rain memory partition and update the available sampler enable conditions.

Select NO to disable the readings and the sampler enable option. When you select NO, the sampler removes the rain memory partition, leaving the memory space available for other reading types.



### 5.18.3 I/O Pin Programming

Pins C, H, and I on the Rain Gauge Connector are user-configured as I/O1, I/O2, and I/O3 (Input/Output pins) respectively. Each pin can be either an input for sampler enabling, or an output for alarms.

**Note**

The state of the I/O lines is not defined when the sampler is OFF.

*Enable*

The enable input requires a pulse signal of 5 to 15 volts. Teledyne Isco offers optional interface modules for converting from a 4-20 mA analog or pulse duration signal.

*Alarms*

The alarm output can be set for any RUNNING PROGRAM or RUN ERROR state. In addition, the CONDITIONS output can report alarm conditions using the parameters the 6712 is configured to measure. You can set thresholds for one or two conditions and the CONDITIONS output can then trigger alarms when the measured parameters exceed the threshold.

Alarm function requires an alarm interface module, factory-installed talking modem, or external digital cellular modem (see Section 5.18.4 *Dialout Alarms*).

Teledyne Isco offers a module designed to provide one, two, or three contact closures. The alarm module can interface the sampler with many types of non-Isco devices. For more information about the alarm module, contact your Teledyne Isco sales representative.

## Example: I/O Pin Programming

Although the screens displayed may vary depending on your site setup, the programming sequence will be the same or similar to the following example.

1. Select OTHER FUNCTIONS to enable the dialout alarm.

```

  RUN "EXTENDED 1"
  PROGRAM
  VIEW REPORT
  OTHER FUNCTIONS
  
```

2. Select hardware and use the down arrow to scroll to the I/O screen.

```

  MAINTENANCE
  MANUAL FUNCTIONS
  SOFTWARE OPTIONS
  HARDWARE
  
```

```

  ↑ I/O1 = NONE
  I/O2 = NONE
  I/O3 = NONE ↓
  
```

3. Select the first pin to program.

```

  SET I/O1:
  
```

From this screen, your choices are viewed by scrolling with the arrow buttons:

```

  PGM RUNNING
  PGM ENABLED
  'A' ENABLED
  'B' ENABLED
  PROGRAM DONE
  'A' DONE
  'B' DONE
  RUN ERROR
  FLOW-THRU
  CONDITIONS
  NONE
  I/O ENABLE
  
```

*Note:* All choices listed are alarm output settings, except for I/O ENABLE. This is the input function to enable the sampler via an external device.

4. If you select CONDITIONS, the sampler will display:

```

  I/O1:
  RAIN NONE
  
```

Depending on what equipment is connected to your sampler, you may see other parameters in addition to RAIN, such as LEVEL, FLOW, VELOCITY, etc. Under CONDITIONS, you can program limits for a condition to trigger the alarm when the measured parameter exceeds its limit. You can use one or two conditions to trigger one alarm, using AND or OR operators.

5. When you select a parameter with the arrow keys and Enter, you can then program the limits for alarm triggering. For example, if you select rain, the sampler will display:

```

  "RAIN" SET POINT:
  1.00 INCHES PER
  1 HOURS, 0 MINUTES
  
```

```

  I/O IS HIGH WHEN:
  ABOVE SET POINT
  BELOW SET POINT
  
```

“I/O IS HIGH” means “Alarm is triggered.” Select ABOVE or BELOW, then select whether or not to reset rainfall history when the alarm is triggered:

```

  RESET RAIN HISTORY?
  YES NO
  
```

Continue with programming I/O2 and I/O3 in the same manner, or if additional alarms are not needed, select NONE.

### 5.18.4 Dialout Alarms

Dialout alarms require the sampler to be equipped with the factory-installed 2400 baud talking modem, or the external digital cellular CDMA or GSM modem. The dialout alarm allows the sampler to notify a contact list when an “alarm” condition exists (is true).

At the transition to the true state, any programmed I/O output can cause the sampler to warn of the alarm condition. As many as three telephone numbers can be entered. The sampler tries each telephone number in succession until the alarm is acknowledged with a callback. For each alarm condition, the sampler will attempt each telephone number entered a maximum of five times, at user specified intervals.

Alarms are set up through the I/O programming menu, shown in Section 5.18.3. “I/O1”, “I/O2”, and “I/O3” represent the three alarms.

#### Example: Dialout Alarms

If the controller is equipped with a dialout modem, it can be programmed to notify a telephone or pager contact list when an alarm condition is true.

Before proceeding the I/O conditions must be defined. Refer to section 5.18.4. These steps program a dialout alarm when the condition defined for I/O1 is true.

1. Select YES to enable the dialout alarm.

```
DIALOUT WHEN IO1
BECOMES TRUE?
YES   NO
```

The controller asks the same question for IO2 and IO3. Select NO.

```
DIALOUT WHEN IO2
BECOMES TRUE?
YES   NO
```

```
DIALOUT WHEN IO3
BECOMES TRUE?
YES   NO
```

2. Using the number entry keys, enter as many as 3 telephone numbers to the contact list.

```
DIALOUT NUMBERS:
1. 9,5555550001
2. 9,5555550002
3. P5550003
```

If the phone number requires extended characters, or if you need to designate a number as a pager, press the decimal key. The controller displays:

```
SELECT CODE
, # * PAGER
```

Use an arrow key to select a code and press Enter to insert it in the number on the DIALOUT NUMBERS screen.

3. Enter the delay time between each attempt. A delay will allow time between attempts so you can return a call to the controller to acknowledge the alarm condition.

```
__ MINUTE
DELAY BETWEEN CALLS
(0-99)
```

*Note:* Numbers may be removed from the list by advancing the cursor to the very end of the number with the right arrow key, then pressing the left arrow key to erase the number.

When the call is answered, the sampler's modem announces the alarm condition (analog talking modem) or sends a digital text message (external cellular modem), and the sampler's three-digit ID number. To acknowledge the call, press the **[★]** (star) key, and the three-digit ID number on your phone. The sampler will reply with an acknowledgment when the keyed entry is correct.

A record of alarms and acknowledgements is available in the Sampling Report. When the sampler detects the alarm condition, it records the type of alarm and the time it occurred. Acknowledgements are a separate Sampling Report entry, recording the time and telephone number that responded to the call.

As mentioned previously, as many as three telephone numbers may be entered. The modem can dial up to 25 digits. Enter numbers using the numeric keys on the sampler keypad. When entering telephone numbers longer than 17 digits, the display will scroll.

Extended characters, the Comma (,), Pound (#), and Star (\*), also may be included in the 25 digits. To enter an extended character, press the Decimal Point key on the sampler keypad. The sampler displays a screen used to select and enter the extended characters. Each comma entered will cause the modem to pause for two seconds before proceeding with the remaining digits.

Phone numbers that are no longer needed can be removed. Advance the cursor to the end of the telephone number and then press the Left Arrow key to erase the preceding character. If the cursor is not at the end of the telephone number, the Left Arrow key will only shift the cursor without erasing any characters.

Dialout telephone and pager numbers are included in the Program Settings Report.

 **Note**

Connecting either the serial output or the standard interrogator cable to the sampler disables the internal dial-out modem. The interrogator or serial output cable must be disconnected before you can use the modem.

### 5.18.5 Pager Numbers

The extended character screen contains a pager option that designates the phone number as a pager. When programmed as a pager number, an identification string will be sent seven times after the pager number is dialed, with a three second delay between strings.

An example identification string would be "828-1", meaning "Alarm condition #1 exists at sampler 828". If more than one alarm condition exists, the string would read similar to "828-1-3.

### 5.18.6 Digital Modem Text Messaging

The sampler can send alarms in the form of text messages containing the same information as that found in voice messages.

To use this option, you must have:

- a cellular phone with text messaging capabilities

- an external digital modem  
recommended: Teledyne Isco's CDMA cellular modem  
part # 68-6710-148  
or GSM cellular modem part #60-5314-563

 **Note**

If an internal voice modem is installed, the sampler will use that modem, and text messaging will be disabled.

When you enter each of the (up to three) phone numbers for the sampler to call, if text messaging is active, a request for the TAP (Telocator Alphanumeric Protocol) server number and communications parameters will be made.

As with voice messaging, the sampler will dial each telephone number up to five times per alarm condition, until the message is acknowledged.

### 5.18.7 Refrigerator Temperature

Teledyne Isco offers a temperature sensor intended for use with the 6712FR Refrigerated Sampler. The optional sensor connects to the Rain Gauge port and uses I/O3 to transmit its temperature readings to the 6712.

 **Note**

If alarms are being used, the temperature sensor is simply plugged into the panel mount on the one- or two-alarm output module. Because the temperature sensor uses I/O3, it cannot be used with a three-alarm output module.

To configure an attached temperature sensor, select "FR-TEMP" as the input for I/O3. The 6712 will display the NEW HARDWARE SETUP screen. Select DONE and the 6712 reconfigures its memory partitions to record the temperature readings.

Temperature readings are updated approximately every 2.5 seconds. The readings are stored as FR-TEMP readings at the data storage interval. You can retrieve a history of temperature readings through the 6712's reports. The temperature data also can be used as a sampler enable condition.

### 5.18.8 Analog Output

Teledyne Isco offers three analog outputs as a factory installed option. The option is installed inside the controller and includes a six-pin connector to interface with external devices.

The analog outputs can be programmed for either 0-to-20 mA or 4-to-20 mA operation. With the exception of rain, any parameter that the 6712 sampler is currently measuring can be used to control any (or all) of the analog output channels. Programming the outputs requires parameter levels at each end of the analog range and then assumes a linear relationship between those points. MANUAL CONTROL of each output is also available.

 **Note**

The internal analog output can not be installed in a controller that has the internal voice modem also installed. Contact the factory for information regarding external cellular modem options.

Flowcharts for analog output screens appear in Appendix A.

## 5.19 Memory

The 6712 Sampler contains 512 kilobytes of battery backed RAM (Random Access Memory) that stores:

- Five sampling programs
- The sampling results from the most recent program
- The rainfall data collected from rain gauges
- The data from a refrigerator temperature sensor
- The data collected from a 700 Series module
- Parameter data collected from an SDI-12 Sonde
- Calculated flow information from the current flow module

The sampling results memory stores up to approximately 1004 events (the actual number is dependent on the number of SDI-12 parameters). The program run and start time information is logged as four events. These four entries are held for the duration of the program. The remaining 1000 are for logging sample events, program events, and errors from the currently running program. If the running program exceeds 1000 events, the data will “roll over.” That is, the sampler will replace the oldest stored event with the newest event. When using an SDI-12 sonde, the sampler logs additional entries at each sample event.

Module, sonde, refrigerator temperature, and rain gauge readings are stored in memory partitions. The storage capacity depends on the reading types, the number of bytes per reading, and the data storage interval.

The sampler clears the sampling results memory when the site description changes. It is important to collect the sampling results before changing the site description – the data can not be retrieved afterwards. Keep in mind that the description may change when selecting an extended program.

The partition data is cleared when the sampler automatically creates and sizes the memory partitions. This occurs when you:

- Select a new program with a different storage interval
- Change the Data Storage Interval in the current program
- Change the programming mode
- Install a new 700 Series Module
- Change 700 Series Module mode of operation
- Add or remove a rain gauge with the Hardware Setup

- Add or remove a refrigerator temperature sensor as I/O3
- Add or remove a SDI-12 sonde parameter with the Hardware Setup
- Reinitialize the sampler

The stored data is lost as the sampler reformats its memory. As a precaution, before clearing the memory, the sampler display will show the following message:

INTERVAL CHANGED --  
DOWNLOAD DATA NOW  
OR LOSE ALL DATA!  
DONE

If you want to keep the stored data, download it before proceeding. When DONE is selected, the sampler clears the stored data and reformats the memory partitions. The sampler then displays the new capacity of the partition memory.

PARTITION MEMORY  
WILL LAST 13 DAYS

If the duration is too short, try changing the data storage interval or eliminating unnecessary reading types in the Hardware or Module Setup. For example, a sampler configured with a 730 Bubbler Module and a rain gauge storing data at a one-minute interval, creates level and rainfall partitions that hold 100 days of readings. Changing the storage interval to two minutes extends the storage capacity to 201 days.

The sampler does not have to be running a program to store readings. When the sampler is on, it stores readings at the selected data storage interval. Once the partition is filled, the readings roll over.

When the sampler is running a program, the partitions become “triggered” by the programmed start time or the first enable time, whichever is later. A triggered partition continues to log readings at the selected interval, but will not replace any readings taken after the trigger event. The sampler fills the partition and then stops recording to preserve the data. The first reading preserved in a full partition is one hour before the trigger event. A full partition can be reset by starting another program or changing storage parameters.

If you need continuous readings for analysis, be sure to collect the readings before the partition fills or rolls over to avoid gaps in the data.

## 5.20 Pressurized Lines

The sampler can obtain samples from pressurized lines, as long as the line pressure remains below 15 PSI (pounds per square inch). Pressures greater than 15 PSI may prevent the sampler from purging the suction line; moreover, extreme pressures can force liquid past the pump, even when the pump is not running.

For more consistent sample volumes from lines under constant pressure, calibrate the samples. Teledyne Isco does not recommend sampling from pressurized lines.

## 5.21 Command Driven Operation

The 6712 controller can be used as a slave to an external controller. The external controller is responsible for determining when to take a sample, how much volume to pump, and where to put the sample. The external controller directly interfaces to the sampler via an RS-232 communications port at 2,400-19,200 baud, 8 data bits, no parity, and 1 stop bit. A comma-separated-value protocol is used by the external controller to make requests, and by the sampler to report results. Use a standard computer connect cable (see Appendix E) to connect the sampler's interrogator port and the external controller.

For information on serial data codes and their meanings, refer to Table 5-5 Serial Data Codes in this section.

The 6712 Sampler will respond to three commands: Turn Sampler On, GET STATUS, and TAKE SAMPLE. All commands must include the instruction set. The checksum value is optional.

The available commands are:

1. Turn Sampler On: STS,2,CS,582<CR>

- "582" is the byte-by-byte sum of the ASCII values in the string "STS, 1,CS".
- "<CR>" is a carriage return signifying the end of the command.
- If the sampler is OFF, this command will turn it ON before returning status info.

2. Get Status: STS,1,CS,581<CR>

"STS,1" instructs the sampler to return the current status.

- "CS,581" is the optional checksum value. The byte-by-byte sum of the ASCII values in the string "STS,1,CS" is 581.
- "<CR>" is a carriage return signifying the end of the command.

3. Take Sample: BTL,2,SVO,100,CS,1039<CR>

The TAKE SAMPLE command is only valid if the sampler is WAITING TO SAMPLE.

- "BTL,2" instructs the sampler to place the sample in bottle 2.
- "SVO,100" instructs the sampler to take a 100 ml sample.



- “CS,1039” is the optional checksum value. The byte-by-byte sum of the ASCII values in the string “BTL,2,SVO,100,CS,” is 1039.
- “<CR>” is a carriage return signifying the end of the command.

## 5.22 Command Driven Sampler Responses

The 6712 Sampler’s response string is the same for each of the three commands. A sample response string is shown below:

```
MO,6712,ID,2424741493,TI,35523.50000,STS,1,STI,35523.41875,BTL,2,SVO,100,SOR,0,CS,xxxx<CR>
```

Note that the sampler’s response is a series of alphabetical and numerical pairs. The alphabetical characters are headings that describe the following numerical value or code. A complete description of each pair is listed below.

MO,6712, is the model number of the sampler.

ID,2424741493, is the sampler’s unique identification number.

TI,35523.50000, is the sampler’s current time.

STS,1, is the sampler’s current status. The possible states are:

1 = WAITING TO SAMPLE.

4 = POWER FAILED (for short time after power is restored).

5 = PUMP JAMMED (must be resolved before continuing).

6 = DISTRIBUTOR JAMMED (must be resolved before continuing).

9 = SAMPLER OFF.

12 = SAMPLE IN PROGRESS.

20 = INVALID COMMAND.

- identifier code is not supported.
- bottle requested is not in current configuration
- sample volume requested is outside its range (10 - 9990 ml)
- day (Set\_Time) must be 5 digits and more recent than 1977

21 = CHECKSUM MISMATCH.

22 = INVALID BOTTLE. (bottle requested is not in the current configuration)

23 = VOLUME OUT OF RANGE. ( the sample volume requested is outside its range (10-9990 ml)

STI,35523.41875, is the most recent sample time.

BTL,2, is the bottle receiving the most recent sample.

SVO,100, is the most recent sample’s volume.

SOR,0, is the results of attempting the most recent sample. The possible results are:

0 = SAMPLE OK.

1 = NO LIQUID FOUND.

2 = LIQUID LOST (not enough liquid to satisfy requirements.)

3 = USER STOPPED (using the Stop Key).

4 = POWER FAILED.

5 = PUMP JAMMED.

6 = DISTRIBUTOR JAMMED.

8 = PUMP LATCH OPEN.

9 = SAMPLER SHUT OFF (while sampling).

11 = NO DISTRIBUTOR.

12 = SAMPLE IN PROGRESS.

CS,xxxx is the byte-by-byte sum of the entire string "MO,...,CS,"

For commands that are not understood (INVALID COMMAND or CHECKSUM MISMATCH) or when no samples have been taken, the most recent bottle information is left off the response string.

# 6712FR Refrigerated Sampler

## Section 6 SDI-12 Sondes

In order to provide you with the flexibility to use the water parameter sensors that best meet your needs, Teledyne Isco has implemented support for SDI-12 protocol. Support of this standard allows you to use SDI-12 compatible devices in conjunction with your 6712 sampler in Extended Programming mode.

### 6.1 Teledyne Isco AQ700 Sonde

The AQ700 Multi-Parameter Sonde can be used in any natural water up to 50 degrees C and 49 feet (15 meters) depth. Its ease-of-use design includes direct USB connection to your computer, real-time data viewing, and LED indicators for operating status.

Using SDI-12 protocol, the AQ700 can connect to the following Teledyne Isco instruments:

- 6712 or Avalanche® Wastewater Sampler
- Signature® Flow Meter
- 2105 Interface Module

There are two versions of the AQ700 to choose from, depending on your monitoring requirements:

#### AQ702

- pH
- ORP (Oxidation Reduction Potential)
- Specific Conductance
- Optical DO
- Temperature
- Depth

#### AQ703

- Everything the AQ702 has, plus:
- Turbidity (w/ wiper)



Figure 6-1 Teledyne Isco AQ700 Multi-Parameter Sonde

## 6.2 SDI-12 Data Parameters

The 6712 Sampler can accept up to 16 parameters from up to ten sensors with SDI-12 addresses from 0 - 9 (refer to Table 6-1). This data can be used in different ways. Data can be logged at user selectable time intervals for later download and processing by Teledyne Isco's Flowlink® program. You can set up sampling programs that will be enabled to run only if conditions based on parameters monitored by the connected SDI-12 devices are met. The sampler can also be programmed to take samples each time certain parameter limits are exceeded.

The data parameters used by the sonde and sampler must match. Otherwise, the equipment could record the data values for one parameter as another's, such as reporting a pH value as being temperature.

Some sondes, such as the AQ700, have "plug and play" setup. Known as "Isco Ready," these sondes can tell the sampler what values they have, their order, and units of measure. Other SDI-12 compatible sondes can still be used, but require manual setup to identify proper data types for each data value reported.

This section shows you how to set up both Isco Ready and other SDI-12 sondes for use with the 6712.

### **WARNING**

**SDI-12 Sondes have not been approved for use in hazardous locations as defined by the National Electrical Code.**

### **CAUTION**

Before you install any sonde, you must take the proper safety precautions. Refer to Appendix C in the back of this manual. Additional safety considerations may be required. Check applicable guidelines, codes, and regulations of federal, state, city, and county agencies.

**Table 6-1 SDI-12 Sonde Parameters**

Parameter	Units	Range	Resolution	Bytes
Temperature	°C	↑ -40-100	0.1	2
Conductivity	mS/cm	0-100	↓ 0.01	
Specific Conductance				
Total Dissolved Solids				
Salinity	ppt	0-70	0.1	1
Dissolved Oxygen	mg/L	0-20		
pH	—	0-14		
ORP	mV	-999-999		
Level	m	0-6.5279	0.0001	2
Ammonium-Nitrogen	mgN/L	0-200	0.1	
Ammonia-Nitrogen				
Nitrate-Nitrogen				
Turbidity	NTU	0-5000	0.0001	
Chloride	mg/L	0-1000		
Chlorophyll	ug/L	0-400		
Other	—99999.0-99999.0		0.0001	4

### 6.3 Scanning For Sondes

The sampler must be in Extended Programming to work with a sonde. You can manually initiate a one-time scan for connected sondes, or the sampler can automatically scan for the presence of sondes on power-up:

- From the main menu, select **OTHER FUNCTIONS**.
- Select **HARDWARE**.
- Press ↓ to move through the hardware screens, until the following appears:

```

RUN "PROGRAM NAME"
PROGRAM
VIEW REPORT
OTHER FUNCTIONS
    
```

- Select Other Functions

```

MAINTENANCE
MANUAL FUNCTIONS
PROGRAMMING STYLE
HARDWARE
    
```

- Select Hardware

```

NO SDI-12 SONDE
AUTO SDI-12 SCAN OFF
    
```

Select "NO SDI-12 SONDE" to start a scan for sondes. If one is found, you can set it up, and the "AUTO SDI-12 SCAN" option will be switched to yes.

Select the “AUTO SDI-12 SCAN” option to manually turn on (or off) automatic scanning for sondes when the sampler is turned on.

If a sonde has already been connected and set up, the hardware screen will instead display a screen similar to the following:

```
SDI-12 DATA:
TEMP0 pH0 SD_CO0
SAL0 05DATA0 DO0
ORP0 LEVEL0 09DATA0
```

Press the arrow keys until “SDI-12 DATA” is blinking, then press ↵. You will see the screen below:

```
NO SDI-12 SONDE
SETUP KNOWN SONDES
SCAN SDI-12 SONDES
```

Select “SCAN SDI-12 SONDES” and press ↵. The system will scan to detect connected sondes. If it detects a newly connected sonde, it will indicate so, and advance to the setup screens:

```
SELECT ADDRESS OF
SONDE TO SETUP:
  _ _ DONE
```

Select the address you want to set up.

```
Company Model
Optional Information
SONDE AT ADDRESS _ _
HAS _ _ DATA VALUES
```

Wait a few seconds for the above display to disappear, or press ↵. You will then be asked if you want to store the parameter data. Refer to “SONDE SETUP - STORING PARAMETER DATA” on page 6-6.

## 6.4 Isco-Ready Sondes

If the scan finds an Isco-Ready sonde, it will automatically recognize the sonde’s data types and units. You can then use Hardware Options to set up the definitions for data storage and calibrate the sonde.

Even with an Isco-Ready sonde, the 6712 may find a parameter that is not on its list of supported parameters (Table 6-1). Such a parameter will be identified with a generic name, such as “05DATA1.” Write down the appropriate data type next to the generic name for your records. Once the data is brought into Flowlink, data sets can be manually changed so that reports show the appropriate labels.

## 6.5 Non-Isco-Ready SDI-12 Sondes

If you have connected an SDI-12 sonde that is not Isco-Ready, you will need to define the sonde's data values.

When you select the address of the sonde you want to set up, the company model and other information will be displayed along with the number of data values the sonde has.

When you advance to the next screen (see #3 below), the data types will be listed as "OTHER" because you have not defined them yet. Select one of the data types to begin defining it.

A list of possible parameters will appear (see #4 below). After you have defined all data types for your sonde, select DONE.

Parameter data storage setup is explained in the next section.

1  
 SELECT ADDRESS OF  
 SONDE TO SETUP:  
 \_\_ \_\_ **DONE**

- Select the address of the sonde you want to set up.

2  
 Company Model  
 Optional Information  
 SONDE AT ADDRESS \_\_  
 HAS \_\_ DATA VALUES

- You can wait a few seconds, or press ↵ to advance to the next screen:

3  
 DATA FROM SONDE \_\_  
 1 = **OTHER**  
 2 = OTHER  
 3 = OTHER --->

- Press an arrow key until the cursor is on the data you want to identify. Then, press ↵. A scrolling screen listing possible parameters will appear.

4  
 SONDE \_\_ , DATA 1:  
 <-- pH  
**TEMPERATURE (°C)**  
 TEMPERATURE (°F) --->

- Make your selection and press ↵.

1  
 DATA FROM SONDE \_\_  
 <-- 1 = **TEMPERATURE (°C)**  
 2 = OTHER  
 3 = OTHER --->

- Repeat the process until you have defined all the data. Press "DONE" when finished.

2  
 DATA FROM SONDE \_\_  
 <--- 4 = pH  
 5 = LEVEL  
**DONE**

- You will then be asked if you want to store the parameter data. Refer to "SONDE SETUP - STORING PARAMETER DATA" in the following paragraphs.

## 6.6 Sonde Setup - Storing Parameter Data

Whether you are using an Isco-Ready sonde or other SDI-12 compatible sonde, you will need to tell the 6712 if you want to store all of the parameter data or data from selected parameters.

Data is stored in memory partitions. A fixed amount of memory is available to store data. If you are using some parameters to simply trigger an event or enable condition, it is not necessary to store the data.

If **all** of the parameters' data will fit in memory, you will be asked if you want to store all of the parameter data. Answering "NO" will still allow you to selectively store parameter data; otherwise, all data will be stored.

To access the setup option in the Hardware menu, select Other Function from the main menu, then choose Hardware. Advance through the screens until you see one that displays SDI-12 DATA, along with the selected parameters.

Select this screen to display the following:

```
NO SDI-12 SONDE
SETUP KNOWN SONDES
SCAN SDI-12 SONDES
```

Select **SETUP KNOWN SONDES** and then select the address of the sonde you want to set up. The sonde model and number of data values will appear briefly. If all parameters' data will fit in memory, the sampler will ask if you want to store all parameter data. If you select **NO**, you will be asked to select which data you want to store, one parameter at a time. The screens will look similar to the example below:

```
SONDE 5, STORE
TEMPERATURE DATA?
YES NO
LABEL IS: TEMP5
```

Select **YES** or **NO** for each parameter until all data storage options have been defined, then select **DONE**. You will be advised that you have a new hardware setup:

```
NEW HARDWARE SETUP--
DOWNLOAD DATA NOW
OR LOSE ALL DATA!
DONE
```

If you have collected all the data, select **DONE**. A partition memory message will appear briefly. If one or more selected parameters can be calibrated, you will then advance to the calibration screen. If you do not want to calibrate or validate, select **DONE** to return to the Hardware option screens.



## 6.7 Sonde Calibration and Validation

You should calibrate your sonde in the lab, according to manufacturer's recommendations.

### Note

The AQ700 sonde's PC software program provides calibration for its sensors. Refer to the AQ700 user manual for complete instructions for calibration of each parameter.

The 6712 allows for field calibration of level, pH, Dissolved Oxygen (DO), and Oxidation Reduction Potential (ORP); however, field calibrations are stored in the sampler, **not in the sonde**. They are used to modify readings from the sonde until a new sonde is connected. When a sonde is moved to another sampler, it will retain internal calibration constants set in the lab, but will not retain any that were set in the field.

Although field calibration is limited to four parameters, you can *validate* any of the available parameters. Validation allows you to immerse the sonde in a known solution and verify the sonde's readings. The validation process does not modify any readings like calibration does; it merely alerts you to inaccurate ones.

No data will be stored, nor will enable conditions be updated, while calibration or validation is being performed.

### 6.7.1 Calibration Procedure

To access the calibration screens from the main menu, select Other Functions > Hardware. Advance to SDI-12 DATA:

NO SDI-12 SONDE  
SETUP KNOWN SONDES  
SCAN SDI-12 SONDES

Select SETUP KNOWN SONDES and DONE. The screen will list the parameters you can calibrate, similar to the example below. The sonde's address will appear after the parameter (such as pH0 and pH5).

SELECT PARAMETER  
TO CALIBRATE:  
pH5 DO5 ORP5 DONE

The parameter selected will determine the content of the calibration screens:

- Level - Enter the current measured level. The sampler will use this value to offset the level reading of the sonde.
- pH - Choose from three different pH solutions: 4.00, 7.00, and 10.00. Next, rinse the probe and place it in the pH buffer. If the reading is off by more than 0.5 pH units, you will be asked to verify the reading.
- DO - Choose between two methods: DO Standard and Saturation. Both require calibration standards, but the

saturation method also requires a temperature reading between 0.0° and 47.0° C, as well as the altitude and barometric pressure.

- ORP - Enter the value of your calibration standard.

When calibration is complete, select DONE to proceed to the validation screen. If you do not want to validate any parameters, select DONE again to return to the Hardware option screens.

### 6.7.2 Validation Procedure

The validation screen appears after you select DONE on the calibration screen. It will be similar to the example below.

```
SELECT PARAMETER
TO VALIDATE:
<-- SAL5 05DATA5 DO5
   ORP5 LEVEL5   -->
```

Select the desired parameter to validate. At the prompt, place the probe in the standard. When the reading is stable, press ↵. The reading will appear at the bottom of the screen.

Select DONE to return to the Hardware option screens.

### 6.8 Disconnecting Sondes

When you have disconnected all sondes, and have interrogated the sampler for all its data, you can remove the sonde(s) from the sampler's hardware list.

From the main menu, select Other Functions > Hardware. Advance through the screens until you see one that displays "SDI-12 DATA." Select this screen to display the following:

```
NO SDI-12 SONDE
SETUP KNOWN SONDES
SCAN SDI-12 SONDES
```

Select "NO SDI-12 SONDE." You will be advised that you have a new hardware setup:

```
NEW HARDWARE SETUP--
DOWNLOAD DATA NOW
OR LOSE ALL DATA!
DONE
```

If you have collected all the data, select "DONE." A partition memory message will be displayed briefly, and you will be returned to the Hardware options screens.

If you do not have a sonde attached, you may want to turn off automatic scanning for sondes. This will eliminate the time taken to scan for sondes whenever the sampler is turned on.

# 6712FR Refrigerated Sampler

---

## Section 7 Remote Operation

The 6712 controller can be operated remotely from external devices. External controlling devices may be a computer via RS-232 serial communications or a telephone via touch-tone commands. Remote telephone operation requires the factory-installed 2400 baud talking modem.

 **Note**

The internal modem cannot be installed in a controller with the analog output option also installed.

### 7.1 Computer Operation

The 6712 controller can be operated from a remote location using a computer. There are two different levels of computer control:

**Menu control** is used to start and stop the current sampler program (or programs if in Extended programming mode) and to access other menu commands. This level of remote operation relies on the sampler program for much of its capabilities.

**External program control** ignores the sampler's program and current state. Using external control, you can turn on the sampler, take a sample, and request sampler status data. The pump, distributor, and serial data output simply respond to the external commands.

To operate the sampler remotely on either level, you must first establish RS-232 serial communication between the computer and the 6712 controller. To do so:

1. Connect your computer to the 6712 controller's interrogator port with a standard interrogator cable, P/N 60-2544-044 (for 9-pin serial ports).
2. On your computer, open a terminal emulator program such as HyperTerminal, and configure it for:
  - baud rate of 19,200 or less
  - no parity
  - 8 data bits
  - 1 stop bit
  - VT100 terminal emulation
3. Using your communications software, connect to the sampler. Press and hold the question mark (?) on the computer keyboard until the sampler returns its banner string. A caret (>) prompt will appear on the screen when the sampler is ready to accept commands.

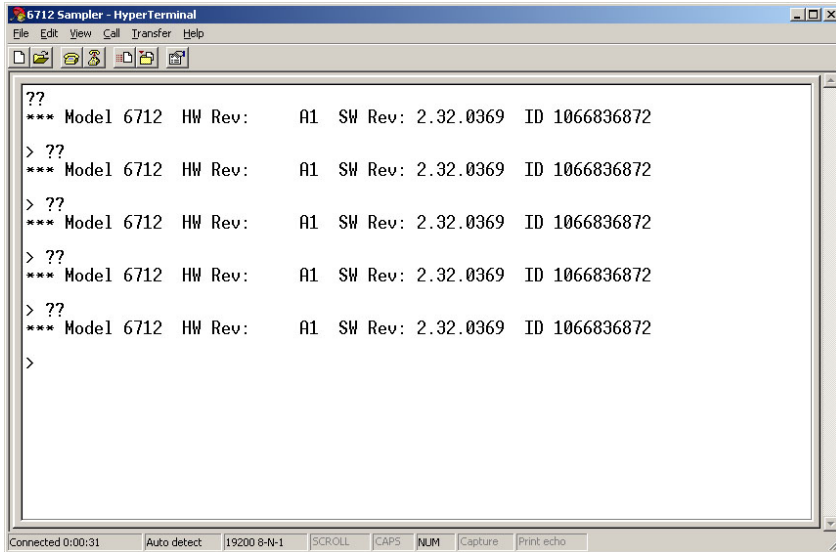

Figure 7-1 Press and hold ?? to connect to the sampler

### 7.1.1 Menu Control

Once you have remotely connected to the sampler, menu commands can be entered from your computer. These menu commands are listed in Table 7-1.

To access the menu commands, type MENU at the “>” prompt and press ENTER. The screen will return a list of the available options. Note that the current state of the controller will determine the available menu options. Then, type the desired command(s), confirming with ENTER.

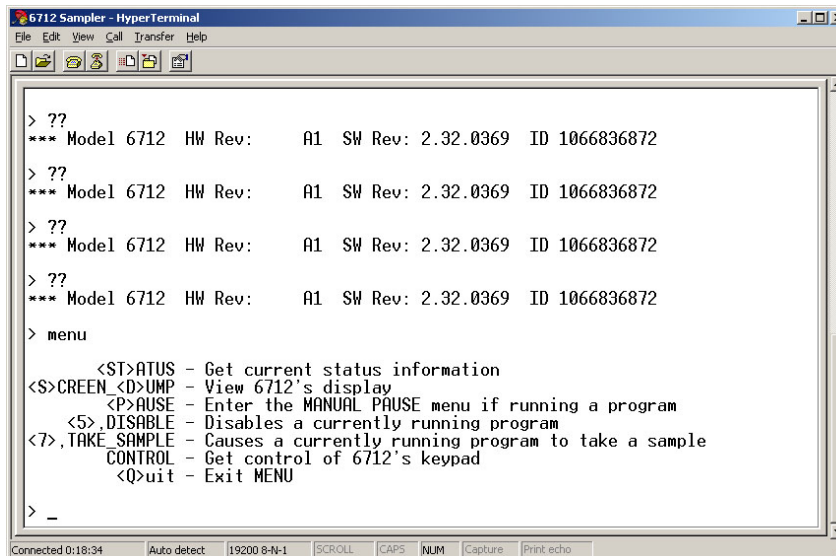

Figure 7-2 Example list of remote menu commands

**Table 7-1 6712 Remote Menu Commands**

Menu Command	Description
0 or START	This command will immediately start any program set to WAIT FOR PHONE CALL and currently waiting for the remote start command (see Section 4.6).
1 or RUN1	This command will load Program 1 as the sampler's current Extended program, reset partition if the storage interval has been changed, and run the program. RUN1 is valid when the sampler is in standby, or when it is waiting for a start command. RUN1 will also run the current program while in Standard programming.
2 or RUN2 3 or RUN3 4 or RUN4	These commands will load the selected program number as the sampler's current Extended program, reset partition data if the storage interval has changed, and run the program. They are valid when the sampler is in standby, or when it is waiting for a start command. The commands are available for Extended programming only.
5 or DISABLE	This command is similar in functionality to a pin F low signal (a signal typically used to enable or disable the sampler from a flow meter). At run time, the sampler starts with the sampler in the enabled state. DISABLE is valid while a program is running. If successful, a display of REMOTE ENABLE IS FALSE will be returned.  A Remote Disable is the highest priority disable. If the sampler is disabled with this command, no condition other than menu command 6, ENABLE, will allow the program to become enabled again.
6 or ENABLE	This command is used to re-enable a disabled sampler. ENABLE is valid while a program is running. If successful, a display of REMOTE ENABLE IS TRUE will be returned.
7 or TAKE_SAMPLE	This command causes the sampler currently running a program to take a sample. The sample will count as one of the program's samples and is placed in the current bottle (Part A's current bottle when using two-part programming). TAKE_SAMPLE is valid while the program is running, after the start time, but not while in the MANUAL PAUSE screens. If successful, a response similar to PUMPING XXML SAMPLE INTO BOTTLE ## will be returned. If not, a response similar to NO SAMPLE, PROGRAM WAITING START will be returned.
ST or STATUS	This command causes the sampler to return its status information and current parameter data.
SD or SCREEN_DUMP	This command causes the sampler to return the information currently displayed on the sampler's screen. The remote screen follows the sampler's display as the information is updated. This mode can be used to observe from a remote location while the sampler is programmed on-site.
P or PAUSE	This command causes a sampler currently running a program to enter the MANUAL PAUSE menu. While you are connected in this mode, the sampler keypad becomes disabled, and your computer's keypad will be redirected to simulate the sampler keypad. The following keys will be activated:  <Enter>, decimal point, and number keys. <Esc>, S, or s = STOP. <Backspace>, L or l, and U or u = Left/Up arrows. R or r, and D or d = Right/Down arrows.

*Sampling reports*

You can retrieve the sampling reports at any time using the same serial connection. Type "Q" to exit the menu. Then at the > prompt, type "REPORT" and press Enter. The sampler controller will send reports as configured.

### 7.1.2 External Program Control

Under external program control, the sampler operates according to received commands. An external program can be as simple as manually entered commands to collect a sample when needed, or as complex as a user-developed process control program (for SCADA or other systems) that directs sample collection according to a system's needs.

The 6712 controller will respond to four commands:

- Turn on the sampler
- Take a sample
- Send status
- Send data

Note that commands and responses are comma-separated pairs. The first set of alpha-characters is an identifier; the second set of numeric characters indicates the value. The 6712 controller will not receive and process the command unless it is followed by a carriage return.

**Turn on the sampler** – If the sampler is OFF, the sampler responds by placing itself in the ON state and returning a status string to report the new status. (See *Send Status* for a description of this string.)

The command to turn the sampler ON and return status is:

STS,2<CR>

**Take a Sample** – This directs the sampler to take a sample. The command specifies how much volume to take, and which bottle to place the sample in. The sampler responds by taking a sample and returning a status string that reports the new status.

An example of a command to take a sample is shown below:

BTL,2,SVO,100<CR>

This example instructs the sampler to place the distributor arm over bottle 2 (BTL,2) and take a 100 ml sample (SVO,100).

While most settings of the sampler program (start times, enables, distribution schemes, etc.) are ignored when responding to external commands, the sampler does rely on two program settings that “configure” the sampler. These settings are:

- Number of Bottles—is used to determine the distributor arm position and the acceptable range for the BTL values.
- Suction Line Length—Used with liquid detection to deliver correct sample volumes according to the SVO value.

**Send Status** – This command causes the sampler to return a data string that identifies the controller and lists its current status.

The command to send current status is:

STS,1<CR>

The status is received as pairs of comma-separated identifiers and values. A complete description of each pair is listed below.

MO,6712, is the model number of the sampler.

ID,2424741493, is the sampler's unique ID number.

TI,35523.50000, is the sampler's current time, shown in a date-time format based on the number of days since 00:00:00 1-Jan-1900, and the time shown as a fraction.

The possible states returned by the STS,1 command are:

- 1 = WAITING TO SAMPLE.
- 4 = POWER FAILED (for short time after power is restored).
- 5 = PUMP JAMMED (must be resolved before continuing).
- 6 = DISTRIBUTOR JAMMED (must be resolved before continuing).
- 9 = SAMPLER OFF.
- 12 = SAMPLE IN PROGRESS.
- 20 = INVALID COMMAND. Possible causes may be:
  - identifier code is not supported.
  - bottle requested is not in current configuration
  - sample volume requested is outside its range (10 - 9990 ml)
  - day (Set\_Time) must be 5 digits and more recent than 1977
- 21 = CHECKSUM MISMATCH. (see "Optional checksum" on page 7-8)
- 22 = INVALID BOTTLE. (bottle requested is not in the current configuration)
- 23 = VOLUME OUT OF RANGE. (the sample volume requested is outside its range (10-9990 ml)

STI,35523.41875, is the most recent sample time.

BTL,2, is the bottle that received the most recent sample.

SVO,100, is the most recent sample's volume.

SOR,0, is the results of attempting the most recent sample.

The possible results are:

- 0 = SAMPLE OK
- 1 = NO LIQUID FOUND
- 2 = LIQUID LOST (not enough liquid)
- 3 = USER STOPPED (using the Stop Key)
- 4 = POWER FAILED
- 5 = PUMP JAMMED

- 6 = DISTRIBUTOR JAMMED
- 8 = PUMP LATCH OPEN
- 9 = SAMPLER SHUT OFF (while sampling)
- 11 = NO DISTRIBUTOR
- 12 = SAMPLE IN PROGRESS

CS,xxxx is the byte-by-byte sum of the entire string "MO,...,CS," (see "Optional checksum" on page 77-8)

**Note**

For commands that are not understood (INVALID COMMAND or CHECKSUM MISMATCH) or when no samples have been taken, the most recent bottle information is left off the response string.

**Send Data** - This command causes the sampler to return the Send Status appended with data from any module, rain gauge, or SDI-12 device. Refer to Table 7-2 to interpret the returned string.

**Note**

This returns the same data as the programmable software option Serial Output, as described in Section 5.17.6 of this manual.

The command to send data is:

DATA<CR>

**Table 7-2 Serial Data Codes**

Identifier	Parameter	Units
B? <sup>1</sup>	Bottle number and time	days since 1-Jan-1900
CR	Current day's rain	tips <sup>2</sup>
CS <sup>3</sup>	Checksum	unsigned long
DE	Description	6712 Sampler
FL	Flow	cubic meters per second
ID	Unit specific identifier	10 digit unsigned long
LE	Level	meters
MO	Model	6712
PE	Percent	percent of full scale
PH	pH	none
PR	Previous day's rain	tips <sup>2</sup>
RA	Rain	tips <sup>2</sup>
RTE	Refrigerator Temperature	degrees celsius
SS	Sampler enable state	logical
TE	Temperature	degrees celsius



**Table 7-2 Serial Data Codes (Continued)**

Identifier	Parameter	Units
TI	Current time	days since 1-Jan-1900
VE	Velocity	meters per second
VO	Volume	cubic meters
VSI	Velocity signal strength	percent
VSP	Velocity spectrum strength	percent
CO_ <sup>4</sup>	Conductivity	milliseimens per centimeter
DO_ <sup>4</sup>	Dissolved oxygen	milligrams per liter
PH_ <sup>4</sup>	pH	none
SA_ <sup>4</sup>	Salinity	parts per thousand
SP_ <sup>4</sup>	Specific Conductance	milliseimens per centimeter
TD_ <sup>4</sup>	Total Dissolved Solids	grams per liter
TE_ <sup>4</sup>	Temperature	degrees Celsius
OR_ <sup>4</sup>	Oxidation reduction potential	millivolts
LE_ <sup>4</sup>	Level	meters
MM_ <sup>4</sup>	Ammonium-nitrogen	milligrams nitrogen per liter
MA_ <sup>4</sup>	Ammonia-nitrogen	milligrams nitrogen per liter
NI_ <sup>4</sup>	Nitrate-Nitrogen	milligrams nitrogen per liter
TB_ <sup>4</sup>	Turbidity	nephelometric turbidity units
CL_ <sup>4</sup>	Chloride	milligrams per liter
CP_ <sup>4</sup>	Chlorophyll	micrograms per liter
FL_ <sup>4</sup>	Flow rate	cubic meters per second
VO_ <sup>4</sup>	Flow volume	cubic meters
xxD_ <sup>4,5</sup>	Other data not listed above	

<sup>1</sup> The three most recent samples will have entries as B?. The “?” will be the first bottle number in the set. If the sample is a grab sample, it will be shown as B0.

<sup>2</sup> Rainfall tips roll over every 256 counts.

<sup>3</sup> The checksum does not include the checksum, carriage return, and linefeed. The string is terminated with <CR><LF>.

<sup>4</sup> A “\_” in the identifier indicates an SDI-12 address.

<sup>5</sup> “xx” matches the data label for the SDI-12 parameter.

*Optional checksum*

Optionally, commands to the sampler can be validated using a checksum. Checksum validation can avoid problems caused by faulty program control or communication lines. When using the checksum, add the CS identifier and a comma at the end of the command, and the checksum value of the string up to the last comma. For example, the command with checksum validation to turn the sampler on would appear as:

STS,2,CS,582<CR>

The numeric value of each character is its ASCII equivalent expressed in decimal format. The checksum of “582” was calculated as shown below.

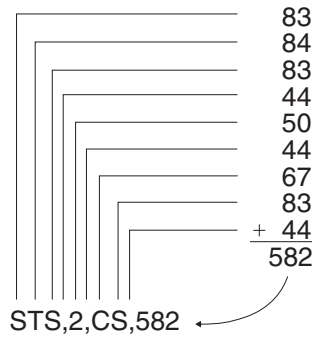

**7.1.3 Remote Control of Sampler Keypad**

To control the sampler keypad remotely, type CONTROL at the “>” prompt and press ENTER. The sampler display appears on your computer monitor as you step through the programming screens. While in this mode, the computer keys will be redirected to simulate the sampler’s keypad, and the sampler keypad itself will be disabled to avoid any conflict. The active keys and their corresponding functions are given in Table 7-3.

**Table 7-3 Remote Control of Sampler Keypad**

Computer	Sampler
<Esc>, S, s	STOP
L, l, U, u, <Backspace>	Left / Up
R, r, D, d	Right / Down
O, o	ON
<Enter>, arrows, decimal, numbers	Same as sampler
NOTE: You will not be able to turn the sampler off remotely.	

## 7.2 Telephone Commands

6712 controllers equipped with an internal voice modem can be operated using telephone commands. This factory-installed option includes a 12 ft (3.6 m) modem cable.

After connecting to the sampler from a touch-tone telephone, command numbers may be entered from the telephone's keypad, followed by the  (pound) button. The commands are listed in Table 7-4.

To use telephone commands:

1. Dial the sampler's telephone number. When the sampler connects, it answers with "Teledyne Isco Sampler Site [number]." If the sampler does not receive a touch-tone command in five seconds, it assumes that a computer modem has called and initiates the modem connect sequence. If this occurs you must hang up and try again.
2. Enter the command. For example, to run program 1, press  .
3. If the command is valid for its current state of operation, the sampler responds with "[command number], please acknowledge." If the command is not valid the sampler responds with the command number followed by three quick beeps. Enter a valid command.
4. Acknowledge the valid command by pressing the number. For the example, press .
5. If the number is incorrect, the sampler responds with your entry followed by three quick beeps. You must re-enter the command (step 2).
6. After the command is confirmed, the sampler replies with "[command number] acknowledge" and executes the command.

To enter additional commands, repeat steps 2 through 5. The sampler will hang up after ten seconds of quiet time.

**Table 7-4 6712 Remote Phone Commands**

Phone Command	Name	Description
<input type="button" value="0"/> <input type="button" value="#"/>	Start	This command will immediately start any program set to WAIT FOR PHONE CALL and currently waiting for the remote start command (see Section 4.6).
<input type="button" value="1"/> <input type="button" value="#"/>	Load and Run Program 1	This command will load Program 1 as the sampler's current Extended program, reset partition if the storage interval has been changed, and run the program. RUN1 is valid when the sampler is in standby, or when it is waiting for a start command. RUN1 will also run the current program while in Standard programming.
<input type="button" value="2"/> <input type="button" value="#"/> <input type="button" value="3"/> <input type="button" value="#"/> <input type="button" value="4"/> <input type="button" value="#"/>	Load and Run Program 2, 3, or 4	These commands will load the selected program number as the sampler's current Extended program, reset partition data if the storage interval has changed, and run the program. They are valid when the sampler is in standby, or when it is waiting for a start command. The commands are available for Extended programming only.

**Table 7-4 6712 Remote Phone Commands (Continued)**

Phone Command	Name	Description
5 #	Disable	<p>This command is similar in functionality to a pin F low signal (a signal typically used to enable or disable the sampler from a flow meter). At run time, the sampler starts with the phone enable in the enabled state. PHONE DISABLE is valid while a program is running. If successful, a reply of REMOTE ENABLE IS FALSE will be returned.</p> <p>A Remote Disable is the highest priority disable. If the sample is disabled with this command, no condition other than command 6#, ENABLE, will allow the program to become enabled again.</p>
6 #	Enable	<p>This command is used to re-enable a phone-disabled sampler. PHONE ENABLE is valid while a program is running. If successful, a reply of REMOTE ENABLE IS TRUE will be returned.</p>
7 #	Grab Sample	<p>This command causes the sampler currently running a program to take a sample. The sample will count as one of the program's samples and is placed in the current bottle (Part A's current bottle when using two-part programming). TAKE_SAMPLE is valid while the program is running, after the start time, but not while in the MANUAL PAUSE screens. If successful, a response similar to PUMPING XXML SAMPLE INTO BOTTLE ## will be returned. If not, a response similar to NO SAMPLE, PROGRAM WAITING START will be returned.</p>

# 6712FR Refrigerated Sampler

---

## *Section 8 Maintenance*

This section describes how to maintain and troubleshoot your 6712FR sampler. If you think your unit requires repair, or if you have questions concerning its operation or maintenance, contact Teledyne Isco's Technical Service Department:

Phone: (800) 228-4373

(402) 464-0231

FAX: (402) 465-3022

E-mail: [IscoService@teledyne.com](mailto:IscoService@teledyne.com)

### **8.1 Maintenance Checklist**

- Clean the condenser coil annually.
- Clean the refrigerator's air filter every 3 months.
- Clean the refrigerator interior and exterior periodically.
- Inspect the pump tube for wear. Replace it if necessary.
- Clean the pump tubing housing.
- Change the suction line if necessary.
- Clean the bottles, suction line, strainer and pump tube.
- Check the humidity indicator.
- Check the controller's internal battery status and replace the battery every five years.
- If the keypad label has bubbles under it, the air inside the controller has expanded. To release this pressure, unscrew the flow meter cable or connector cap on the back of the controller. Push down on the label to force the air out, then re-tighten the cable connector or cap.

### **8.2 Cleaning Guidelines**

#### **8.2.1 Refrigerator**

The refrigerator's exterior may be periodically cleaned with soapy water using a sponge or nonmetallic brush to keep it free of corrosive solutions, grease, oil, etc. After cleaning, it should be wiped dry. Automotive wax may be applied to the interior and exterior surfaces to make them easier to clean and more resistant to corrosion. Do not direct a hose spray toward the underside or into the front grill of the refrigerator. The vacuum formed plastic refrigerator interior may also be cleaned with soap and water as necessary.

Because the refrigerator uses a forced-air system, dust and debris will collect on the condenser coil and surrounding areas. If the refrigerator is not cleaned periodically, damage due to overheated components may result.

### 8.2.2 Controller

When necessary, clean the controller with warm soapy water. To prevent moisture damage, always cap the connectors at the back of the controller tightly. Keep the controller power cable connected, or replace the protective cap (shipped with the sampler) over the power source connector.

Make sure the two pump drain holes (located on the bottom right-hand side of the pump, beneath the pump band) are open and free of debris or buildup.

### 8.2.3 Cleaning or Replacing Wetted Parts

For general cleaning, you can wash the strainer and sample bottles with a brush and soapy water, then rinse with clean water. You can clean the liquid path through the wetted parts by placing the strainer in a cleaning solution and pumping it through the delivery system. Next, place the strainer in clean water and pump it through the delivery system to rinse it. If these items are severely contaminated, replace them.

For application-specific requirements, consult with your laboratory to establish cleaning or replacement protocols.

 <b>Note</b>
---

For critical sampling applications, consider replacing the suction line, pump tube, and discharge tube. Replacement eliminates the possibility of any cross contamination from previous sampling sites.

### 8.2.4 Air Filter

The air filter prevents dust, lint, and other debris from circulating around the cooling system. Clean the filter about every 3 months; more frequently under severe operating conditions.

To remove the filter:

1. Disconnect power from the refrigerator.
2. Remove the screws securing the refrigerator's grille. (See Appendix D Replacement Parts.)
3. Remove the grille and filter.
4. Steam clean the filter or wash it in hot, soapy water. After washing, treat the filter with a standard filter coat.

### 8.2.5 Condenser

Clean the condenser and surrounding areas annually; more frequently under severe operating conditions.

1. Disconnect power from the refrigerator.
2. Remove refrigerator's back panel. (See Appendix D, Replacement Parts).
3. Vacuum the fan, compressor, and surrounding areas.
4. Check the fan for freedom of movement. If the fan and fan motor do not rotate freely, replace the motor. (You cannot oil the sealed fan motor bearings.)
5. Remove the front grille and filter. Vacuum the condenser coil and surrounding areas.
6. Clean the filter before replacing it.

7. Replace the back panel and front grille.

### 8.3 Maintenance Screens

When you select OTHER FUNCTIONS from the main menu, and then select Maintenance, the following screen will be displayed:

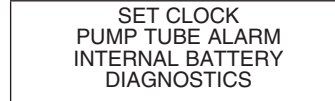

Using these options, you can set the sampler's time and date, set the number of pump counts for the pump tube warning, reset the battery warning for the internal battery, and run a set of diagnostic tests for troubleshooting purposes.

#### 8.3.1 Set Clock

##### Entering Times and Dates

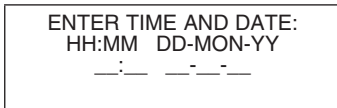

- Move from one field to another by pressing the arrow keys.
- Change a setting in a field by typing a number. Press ↵ to accept the new setting.

Teledyne Isco ships samplers from the factory with the clocks set to the correct Central Standard Time. Reset the clock when installing the sampler in a different time zone, for daylight savings time, or when needed.

When setting the clock and calendar, use a 24-hour clock for times and the day-month-year format for dates. The illustration at the left shows blanks for each position that accepts an entry. The positions are called fields. When this screen appears on your sampler, the fields will contain the sampler's current settings for the time and date.

- To move from one field to another without changing the setting, press the arrow keys. Use this technique when you want to change only one or two settings.
- Change the setting by typing a new number. Press ↵ to accept the new setting.

For example, to enter 2:00 p.m. (2:00 p.m is 14:00 on a 24-hour clock), type 14. Press ↵. Next, type 0 (zero) for the minutes, and press ↵. To enter a date, such as January 22, 2001, type: 22 ↵ 01 ↵ 01 ↵.

**Table 8-1 Setting the Clock and Calendar**



Select OTHER FUNCTIONS.

**Table 8-1 Setting the Clock and Calendar (Contin-**

2	MAINTENANCE MANUAL FUNCTIONS PROGRAMMING STYLE	Select MAINTENANCE.
3	SET CLOCK PUMP TUBE ALARM INTERNAL BATTERY DIAGNOSTICS	Select SET CLOCK.
4	ENTER TIME AND DATE: HH:MM DD-MON-YY 14:00 22-JAN-01	Enter the time and date.
5	SET CLOCK PUMP TUBE ALARM INTERNAL BATTERY DIAGNOSTICS	Press STOP to return to the main menu.

### 8.3.2 Pump Tube Alarm

The sampler tracks the pump counts in both the forward and reverse cycles with a resettable counter. When the counter reaches the default count of 1,000,000 or the count you have entered, the sampler displays a message, “WARNING! REPLACE PUMP TUBE.” The message appears each time you turn the sampler on or run a program until you reset the counter.

After replacing the pump tube (see page 8-7), reset the count to zero so the sampler can begin tallying the pump counts for the new tube. Replacing the pump tube does not reset the counter.

## WARNING

**Pump may actuate without warning. To avoid injury, sampler must be off when pump housing cover is removed for inspection or tubing replacement.**

Experience may suggest a significantly different pump tube life. You can change the alarm count to represent the pump tube life for your application. The example below shows how to set the alarm count and reset the pump counts.

**Table 8-2 Resetting the Pump Counter**

1	RUN PROGRAM VIEW REPORT OTHER FUNCTIONS	Select OTHER FUNCTIONS.
---	--	-------------------------



**Table 8-2 Resetting the Pump Counter (Continued)**

2	<p>MAINTENANCE MANUAL FUNCTIONS PROGRAMMING STYLE HARDWARE</p>	Select MAINTENANCE.
3	<p>SET CLOCK PUMP TUBE ALARM INTERNAL BATTERY DIAGNOSTICS</p>	Select PUMP TUBE ALARM.
4	<p>1024000 PUMP COUNTS, WARNING AT 1000000</p>	The sampler displays this screen briefly to give you the current pump-count information. The first line shows you the pump counts tallied since the counter was last reset. The second line shows the current alarm setting.
5	<p>1024000 PUMP COUNTS, RESET PUMP COUNTER? YES NO</p>	To reset the counter to zero, select YES. Always reset the counter after replacing a pump tube. Select NO when merely checking the current count.
6	<p>WARNING AT 1000000 PUMP COUNTS (1 - 99)00000)</p>	If necessary, change the pump-count alarm setting by typing the first two digits of the new setting. The sampler accepts entries between 1 and 99. For example, to increase the count to 1,500,000, enter 15.
7	<p>SET CLOCK PUMP TUBE ALARM INTERNAL BATTERY DIAGNOSTICS</p>	Press STOP to return to the main menu.

**8.3.3 Internal Battery Warning**

The internal lithium battery preserves the sampler's memory when power is removed. For an explanation of how to replace the lithium battery, go to Section 8.7

**Table 8-3 Checking and Replacing the Internal Battery**

1	<p>RUN PROGRAM VIEW REPORT OTHER FUNCTIONS</p>	Select OTHER FUNCTIONS.
2	<p>MAINTENANCE MANUAL FUNCTIONS PROGRAMMING STYLE HARDWARE</p>	Select MAINTENANCE.
3	<p>SET CLOCK PUMP TUBE ALARM INTERNAL BATTERY DIAGNOSTICS</p>	Select INTERNAL BATTERY.
4	<p>WARNING! REPLACE INTERNAL BATTERY BEFORE 17-OCT-97</p>	The sampler displays this screen briefly to show you the expiration date.
5	<p>DID YOU REPLACE THE INTERNAL BATTERY? YES NO</p>	After replacing the battery, select YES. Select NO only if checking the expiration date. Resetting the alarm directs the sampler to calculate a new expiration date, five years in the future. If you reset the alarm without replacing the battery, the sampler will not be able to alert you to the battery's impending expiration.

**Table 8-3 Checking and Replacing the Internal Battery (Continued)**

6	SET CLOCK PUMP TUBE ALARM INTERNAL BATTERY DIAGNOSTICS	Press STOP to return to the main menu.
---	---	--

**8.3.4 Diagnostics**

The sampler has several self-diagnostic tests that check the memory (both the RAM and ROM), pump, and the distributor arm position. It also contains screens that let you reset the sampler's program settings and memory to factory settings.

You do not need to run the diagnostic tests on a routine basis. The diagnostic tests are a troubleshooting tool; Teledyne Isco's Customer Service department staff may ask you to run these tests when they work with you in diagnosing problems with your sampler.

Access the diagnostic screens by selecting Other Functions from the main menu, then Maintenance, and Diagnostics. The unit will automatically test the memory and display; you can choose whether it tests the pump and distributor, and whether it reinitializes the unit to its original factory settings.

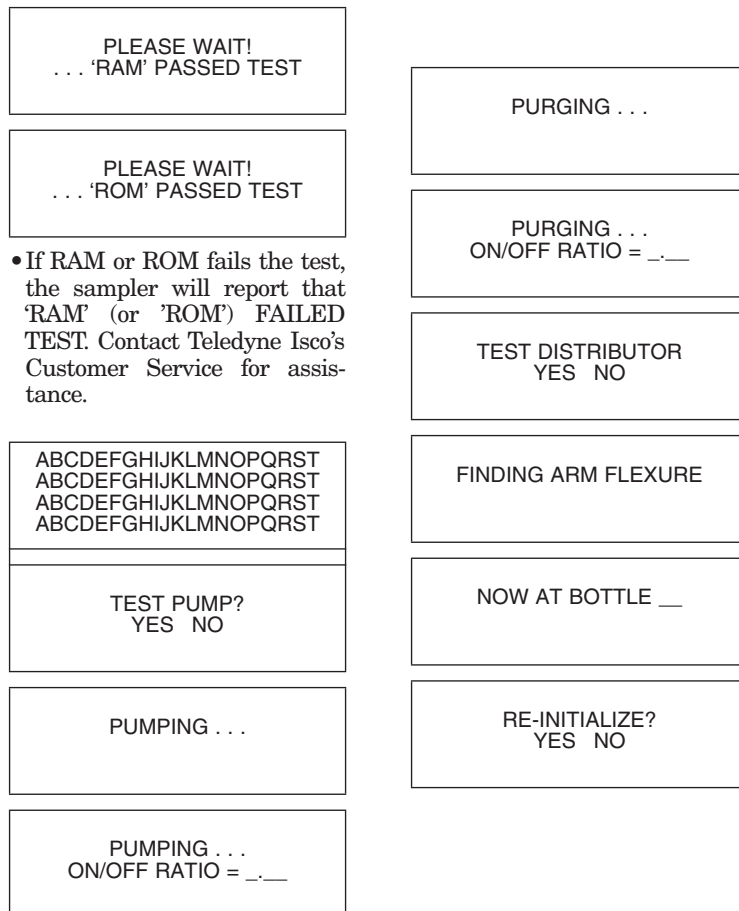

**Memory Test** – Screens 1 and 2 at left show you the diagnostic tests for the unit’s memory. If either screen shows you a message saying that the memory failed the test, contact Teledyne Isco’s Customer Service.

**Display Test** – Screen 3 shows you the display test. You should see the test pattern illustrated in the screen. If the pattern does not match the illustration, the display or its circuitry require repair.

**Pump Test** – Screen 4 lets you start the pump test by selecting YES. As the sampler runs the test, it first runs the pump forward for a short period. Next, it displays an ON/OFF ratio number. After displaying the forward pumping ratio, the sampler reverses the pump to obtain a purge ratio. The acceptable range is between 0.80 and 1.25. If either ratio is outside the acceptable range, the pump requires repair. You do not need to pump liquid while running the test, and you can run the test with or without a tube in the pump.

<b>CAUTION</b>
----------------

Tests indicate that the pump produces sound levels in excess of 85db at one meter. Prolonged exposure to this sound level could result in hearing loss and requires the use of protective ear plugs.

**Distributor Test** – The distributor test is provided for factory personnel to verify the distributor’s position as it rotates through the 24 positions. (screens 9 through 11). The distributor arm flexes slightly when it contacts the stop, and the sampler measures this flexure. The sampler uses this measurement to position the arm accurately over each bottle.

**Reinitialize Controller** – The sampler allows you to reset all the program settings to the settings shipped with the sampler (screen 12). Reinitializing also clears the memory that stores the sampler’s event log and module data. **Use this option cautiously.**

## 8.4 Replacing the Pump Tube

Replace the pump tube only with Teledyne Isco’s 6712 pump tubing. **Other pump tubes will not work.** The 6712 pump tubing is easily recognized by the blue alignment collars.

Improper pump tubes include those made for Teledyne Isco’s other samplers (3700, GLS, etc.) and tubing from non-Teledyne Isco vendors. Also note that the discharge tube is not the same as the pump tube. You could experience several problems if you install the wrong pump tubing:

- The sampler will not pump the liquid.
- Pump jams
- Inaccurate sample volumes
- Faulty liquid detection

Inspect the pump tube periodically. Replace the tube when it cracks or appears worn. Inspect the tube frequently when the sample liquid contains a high percentage of suspended or abrasive solids.

 **Note**

The importance of regular tubing replacement cannot be overstated. The key is to replace the tube before failure, not after. When a pump tube ruptures, grit and other abrasive debris can be driven into the pump shaft seal. Over time, this abrasive material will degrade the pump seal, jeopardizing the NEMA 4x 6 rating of the controller.

Failure to maintain the pump tube may result in permanent damage to the sampler. Check the condition of the pump tube regularly and if the tube shows signs of fatigue or wear, replace it immediately. A properly maintained sampler will provide the years of reliable service that is expected of an Isco Sampler.

**8.4.1 Checklist For  
Replacing Pump Tube**

1. Disconnect power from the sampler.
2. Loosen the liquid detector's cover by unscrewing the black knob on top of the detector. Unlatch the pump band. (The band is the rounded metal band that holds the tube in the pump.)
3. Pull the tube away from the bulkhead fitting. Pull it from the pump and detector.
4. Clean the pump rollers and the inside of the pump band.
5. Thread the new tubing through the pump so that the tube follows its natural curve around the pump rollers. You may need to move the pump rollers to make the installation easier.
6. The blue collars on the tube help align the tube in the detector and pump. Align the tube by placing the collars in the grooves inside the liquid detector.
7. Close the detector's cover and tighten the black knob. Close the pump strap and latch it.
8. Reset the pump-tube counter. (See example in table 8-2.)
9. Take a "dry" grab sample to test the tube installation.

**WARNING**

**The pump's safety lock prevents the sampler from running the pump when the pump band is open. DO NOT tamper with the safety mechanism. The pump is extremely powerful. The pump rollers can injure you severely if the sampler activates the pump while you are working on it or inside it. Disconnect power from the sampler before replacing the pump tube.**

**Note**

**To extend the pump tube life:**

- Always use Isco pump tubes.
- Install the tube properly, aligning the blue collars correctly in the liquid detector's grooves.
- Follow the natural curve of the tube when wrapping the tube around the pump rollers.
- Minimize the line rinses and sampling retries in the sampling programs
- Use the shortest possible suction line.

**Conditions that shorten tube life:**

- Improper installation.
- Abrasive materials suspended in sample liquid.
- Frequent line rinses.
- Long purge cycles, such as those used with long suction lines.

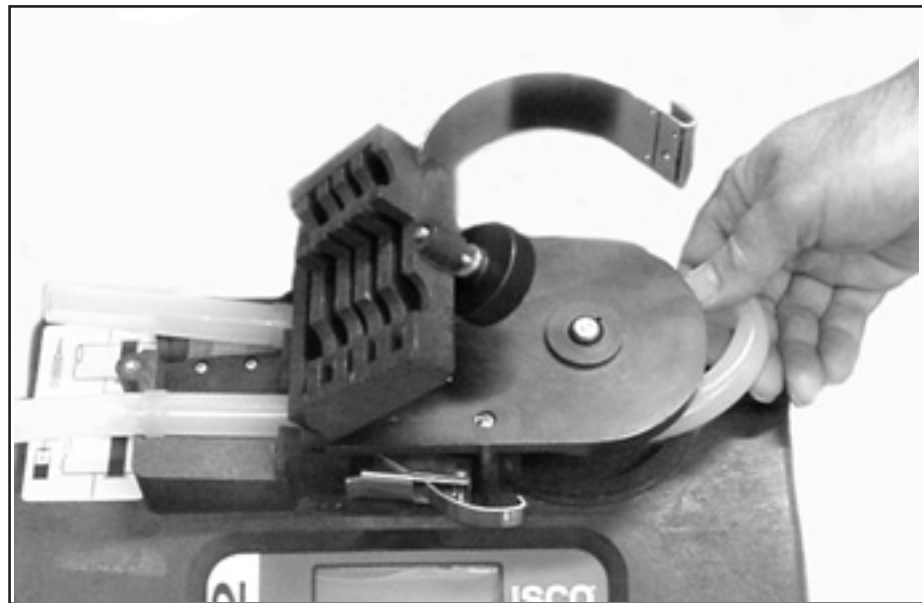

*Figure 8-1 Removing and Replacing the Pump Tube*

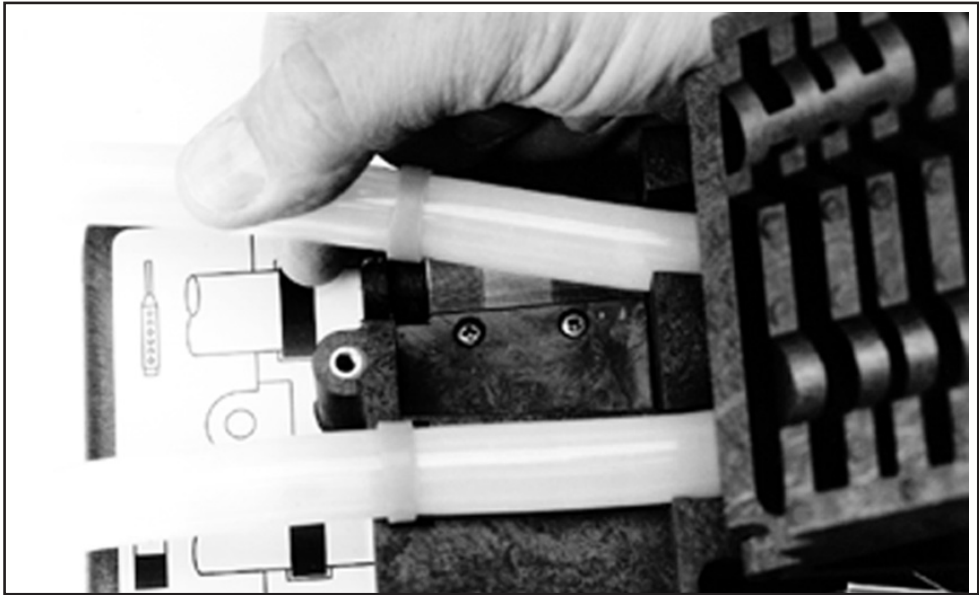

Figure 8-2 *Placing the Pump Tube in the Liquid Detector*

## 8.5 Opening the Controller Case

You will need to open the controller case to gain access to:

- The desiccant bag that dries the controller's interior
- The battery that provides backup power to the controller

### CAUTION

The circuit boards can be damaged from a discharge of static electricity. Always use an antistatic mat when opening the controller to protect the circuit boards.

#### To open the case:

1. Pull the discharge tube and pump tube away from the bulkhead fitting.
2. Remove the distributor arm by unscrewing the nut that attaches the arm to the distributor shaft. **DO NOT ROTATE THE DISTRIBUTOR ARM MANUALLY; THIS WILL SEVERELY DAMAGE THE DISTRIBUTOR DRIVE GEARS.**
3. Remove the controller from the refrigerator.
4. Open the case by removing the 11 screws that attach the case bottom to the case top.

#### Note

The case top and bottom fit together with a sealed tongue-and-groove joint. Any damage — nicks or cuts — to the tongue, groove, or sealing gasket prevent the case from sealing completely when you close it. Use extreme care when opening the case to avoid damaging the joining surfaces.

Refer to Figure 8-3 for the location of the desiccant box. To gain access to the main circuit board and battery, remove the two distributor connectors and the EMI shield.

## 8.6 Replacing the Desiccant

A humidity indicator, labeled "INTERNAL CASE HUMIDITY," is located to the right of the keypad. It indicates the amount of moisture present inside the control box. The paper indicator is **blue** when the control box is dry.

The control box is a completely sealed unit. You do not need to open the control box during normal operation. The 6712 Samplers use a desiccant bag inside the controller case to prevent moisture damage to its electronic components. Thus, the humidity indicator should remain blue under normal conditions. If moisture does accumulate, the numbered areas on the indicator will turn light **pink** or **white**, starting with the area numbered "20." This indicates that the relative humidity inside the control box exceeds 20%. As more moisture accumulates, the areas numbered "30" and "40" will turn light pink or white, indicating relative humidities of 30% and 40% respectively.

If the 30% area of the humidity indicator turns light pink or white, open the control unit, inspect it for leaks, and replace the desiccant bag.



**CAUTION**

Do not attempt to reactivate the used desiccant. Reactivation may cause desiccant to leak out of the bag, causing mechanical damage inside the controller.

Follow the instructions in Opening the Controller Case in Section 8.5 to open the controller. Remove the bag from the cardboard box (part #69-9003-518) at the front of the case and replace it with a fresh bag of desiccant (part #099-0002-00).

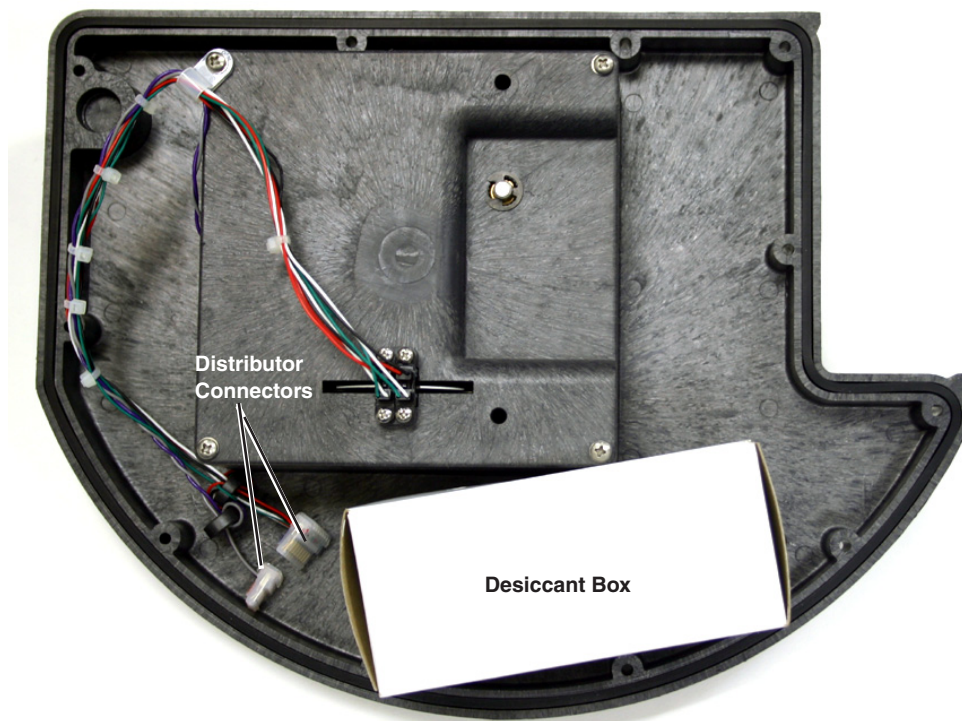

Figure 8-3 Opening the Controller



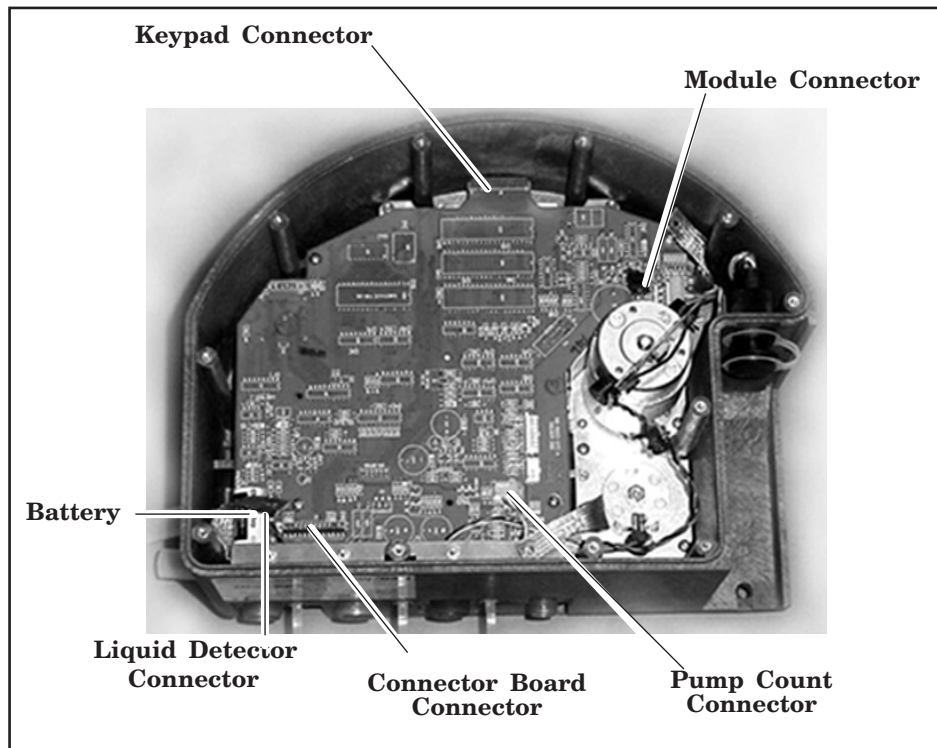

Figure 8-4 Main Circuit Board Connections

## 8.7 Replacing the Internal Battery

A lithium battery housed inside the controller maintains power to the sampler's memory when the controller is disconnected from a power source. If it discharges completely, the sampler will lose all program settings and all data stored in memory when the external power source is disconnected.

### Battery Status Display

WARNING!  
REPLACE INTERNAL  
BATTERY BEFORE  
17-OCT-06

DID YOU REPLACE THE  
INTERNAL BATTERY?  
YES NO

The battery requires replacement every five years. The sampler keeps track of the time that has passed since the battery was installed. To view this information, select INTERNAL BATTERY from the Maintenance screen (see example at left). After 5 seconds, the sampler asks if you have replaced the internal battery (see example at left).

Select YES to reset the countdown to 59 months from the current date.

While replacing the battery, it is likely that the stored readings will be lost and your program will revert to the default program. Before proceeding, retrieve the stored data and record your program settings.

### Note

Teledyne Isco recommends you replace the battery every five years, as soon as the battery warning appears. To ensure that the replacement meets Teledyne Isco's specifications, use only Isco replacement batteries. (See *Appendix D, Replacement Parts*.)

**To replace the internal battery:**

1. Open the controller case. Separate the case bottom and top by removing the two distributor connectors.
2. Lift the desiccant box from the case.
3. Remove the EMI shield and grounding straps by loosening the five  $\frac{1}{4}$ -inch stop nuts.
4. Disconnect the module, liquid detector, and pump count connectors from the main circuit board.
5. Remove the three screws and the  $\frac{1}{4}$ -inch stud attaching the main circuit board to the case.
6. Detach the main circuit board from the keypad connector by pulling gently upward on the edges of the board next to the connector. Pull the main board up until the keypad connector is almost even with the edge of the case. Next, detach the main circuit board from the connector board.
7. De-solder the existing battery (cylindrical or coin style), using care to prevent damage to the circuit board.
  - a. Insert the new battery and solder it in place

 **Note**

Poor soldering techniques can easily damage a printed circuit board. The battery should be replaced by a skilled technician.

**WARNING**

**Danger of explosion if lithium battery is incorrectly replaced. Replace with the same type, ensuring correct polarity. Do not dispose of used lithium battery in fire.**

8. Reconnect the main circuit board to the connector board before reconnecting it to the keypad. Replace the  $\frac{1}{4}$ -inch stud and the three screws, and reconnect the module, liquid detector, and pump count connectors.
9. Replace the EMI shield and grounding straps. Reconnect the two distributor connectors.
10. Ensure that all connections and hardware are secure. Replace the desiccant and close the case.
11. Reset the battery alarm.

## 8.8 Error Messages

If the sampler detects an error that prevents it from taking a sample or continuing the program, it displays an error message.

OPERATION ERROR:  
PUMP JAMMED

There are messages for the following conditions:

- PUMP JAMMED
- DISTRIBUTOR JAMMED
- PROBABLE OVERFLOW
- POWER FAILED
- LOW BATTERY
- USER STOPPED
- NO DISTRIBUTOR ARM
- NO LIQUID DETECTED
- NO MORE LIQUID
- PUMP LATCH OPEN
- SAMPLER SHUT OFF
- BOTTLE FULL
- SAMPLE IN PROGRESS

### Error Messages

ERRORS HAVE OCCURRED  
DURING PROGRAM

FATAL ERROR  
NO DISTRIBUTOR ARM

Since the sampler may encounter more than one error during a program, it does not display the messages continuously. Instead, it records each error and the time it occurred in the Sampling Results and Combined Results report. It alerts you to the recorded errors by displaying the message, "ERRORS HAVE OCCURRED DURING PROGRAM."

If the sampler detects a low battery condition, it stops the running program and displays the "LOW BATTERY" error message. A low battery condition exists when five consecutive sample events have resulted in a POWER FAILED error message.

**Fatal Error** – The Fatal Error message will only show up if you are using a multiple bottle configuration and the distributor system fails. Failing the test can indicate any of the following conditions:

- The distributor arm is not attached to the sampler.
- The distributor-arm stop inside the center section is missing or broken.
- The distributor drive mechanism inside the controller is malfunctioning.

## 8.9 Pump Tube Warning

WARNING: REPLACE  
PUMP TUBE

Occasionally, the sampler displays a warning message to alert you to a potential problem. The warning, REPLACE PUMP TUBE, reminds you to check the condition of the pump tube. Instructions regarding the pump tube can be found elsewhere in this section.

## 8.10 Servicing the Refrigerator

### 8.10.1 Electrical System

Before servicing the refrigerator, disconnect it from power. This precaution will protect you from the possibility of electric shock when working with the refrigerator.

Access the electrical and refrigeration components by removing the nine screws on the back of the refrigerator (See Appendix D, Replacement Parts).

### WARNING

**Removing the front or back panel exposes electrical and mechanical hazards. Disconnect the power before performing any service activities. Troubleshooting and repair activities should be performed by a qualified refrigeration technician.**

The temperature control box assembly, which houses the thermostat logic circuit board, the transformer, and the solid state relay, is located on the left-hand side of the refrigerator base as shown in Figure 8-5. Access to these components can be gained by removing the four screws securing the lid of the temperature control box. See Figure 8-6.

You can remove the temperature control box from the refrigerator by removing the screws from its mounting plate and disconnecting the wires from the backside of the box. See Figures 8-7 and 8-8.

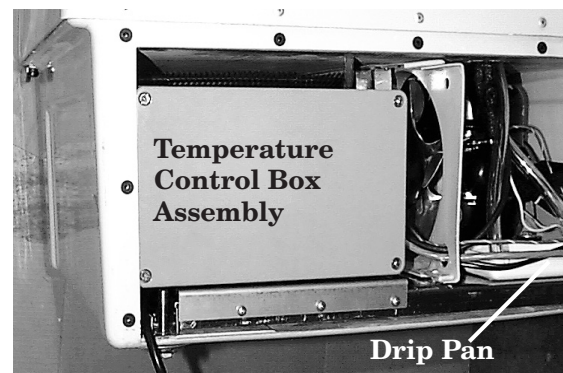

Figure 8-5 Rear View of the 6712FR

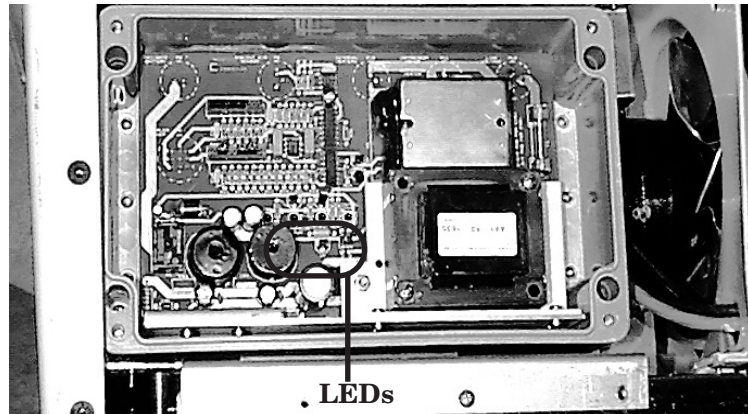

Figure 8-6 Thermostat Logic Circuit Board



Figure 8-7 Control Box Wiring

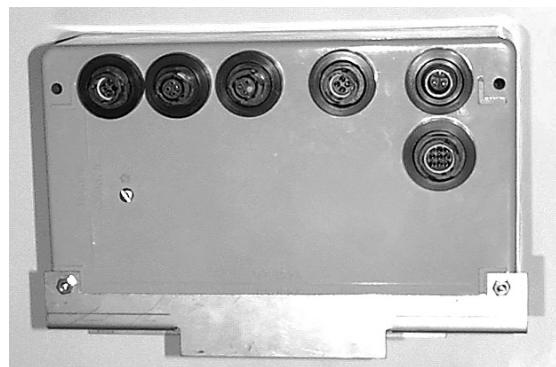

Figure 8-8 Control Box Connections

The ambient air sensor samples the air temperature outside the refrigerator. It is located in the temperature assembly located on the right of the refrigerator grille. If the ambient temperature is cold, three heaters will be turned on by the circuitry.

Two of the heaters are located on the sides of the evaporator plate inside the refrigerator and one heater is located on the compressor.

The fuse, F2, is included on the supply side of the heaters to prevent an electrical hazard in the event of a fault in either heater. Refer to Appendix D Replacement Parts List for replacement fuse part numbers.

The heaters prevent the sample from freezing when the outside air temperature falls below freezing. The compressor will cycle approximately the same amount of times at cold temperatures as at room temperatures.

The ambient air temperature signal comes from the sensor into the circuit board. The signal is then sent to an oscillator. Depending on the temperature, the voltage will vary. This varies the duty cycle of the oscillator, which in turn, varies the duty cycle of the heaters. This circuitry is linear; at 65°F the heaters will begin to come on and at -35°F the heaters will be on continuously. When the heaters are on, the internal heat LED indicator will be lit.

The internal temperature sensor is a thermistor that samples the internal air temperature of the refrigerator. It is mounted at the top of the refrigerator's interior. The internal temperature signal comes from the sensor, through the plug in the thermostat/wiring housing assembly, and into the board. The setting on the temperature control knob comes from the potentiometer, through the plug in the thermostat/wiring housing assembly and into the board. If the interior of the refrigerator is warmer than the temperature control potentiometer setting, the internal temperature LED indicator will be lit. The temperature control potentiometer is located in the thermostat/wiring housing assembly.

The evaporator temperature sensor is mounted on the front of the evaporator plate. The signal from the sensor comes through the connector in the thermostat/wiring housing assembly and into the circuit board. The evaporator temperature LED indicator will be lit if the evaporator temperature is warm (and all the frost has been melted).

The operation of the compressor and the compressor run LED indicator is determined by the temperature control potentiometer setting, the internal refrigerator temperature, and the evaporator temperature.

**It is not recommended that the user attempt any calibration adjustments.**

Below is the operation of a compressor cycle assuming that the compressor is already running.



As the compressor runs, the temperature of the evaporator will fall below 32°F (0°C) and the evaporator temperature indicator, located on the circuit board, will go out. The internal temperature and the compressor run indicators will both be lit. The compressor will continue running until the internal air temperature of the refrigerator reaches the temperature set on the temperature control knob. Once this temperature is reached the internal temperature indicator will go off, the compressor run indicator will go off, and the compressor will shut off. After the compressor shuts off, the refrigerator melts the frost that accumulated on the evaporator while the compressor was running. Once the evaporator temperature has warmed to the calibrated temperature (approximately 2°C) the evaporator temperature LED indicator will turn on.

When the refrigerator's internal temperature gets warmer than the temperature setting, the internal temperature indicator will light. When both the evaporator temperature and the internal temperature indicators are lit, a signal is sent to the solid state relay. This activates the refrigerator's compressor and turns on the compressor run indicator. The compressor will continue to run until the internal temperature indicator goes out.

If a problem with the circuitry is suspected, remember that the compressor shuts off when the internal temperature sensor reaches the setting on the temperature control knob. But, to turn the compressor on, both the internal temperature sensor and the evaporator temperature sensor must be warm. The compressor/fan solid state relay may be replaced but **do not attempt to replace any other components**. Otherwise, the calibration of the circuitry will be disturbed. It is suggested that the entire board be replaced or the board be returned to the factory for repair.

### 8.11.2 Refrigeration System

The refrigeration system is shown schematically in Figure 8-9. The charge capacity of the system is 4.5 ±0.5 oz of R-134a refrigerant.

<b>CAUTION</b>
----------------

All refrigeration repair work must be performed by a qualified refrigeration technician.

Always purge the system with nitrogen. NEVER USE AIR to purge the system.

Always recover the refrigerant.

When recharging, do not leave a line tap in the refrigeration system because of possible corrosion or leakage problems.

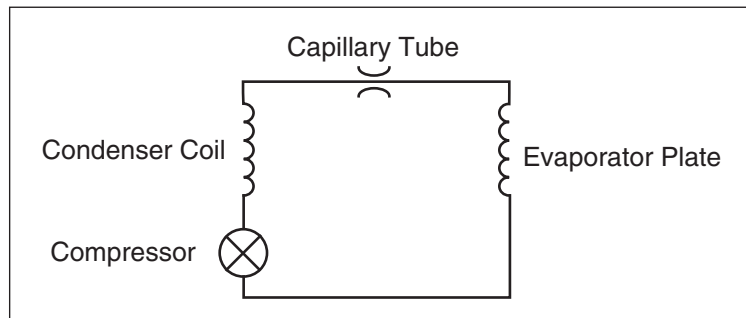

Figure 8-9 Refrigeration System Schematic

Equipped with external overtemperature and overload protection, the compressor may fail to start immediately when power is momentarily interrupted or when the thermostat setting is changed. The overload relay normally trips repeatedly until the refrigerant pressure equalizes. This does not indicate a malfunction.



# 6712FR Refrigerated Sampler

## Appendix A Menu Flowcharts

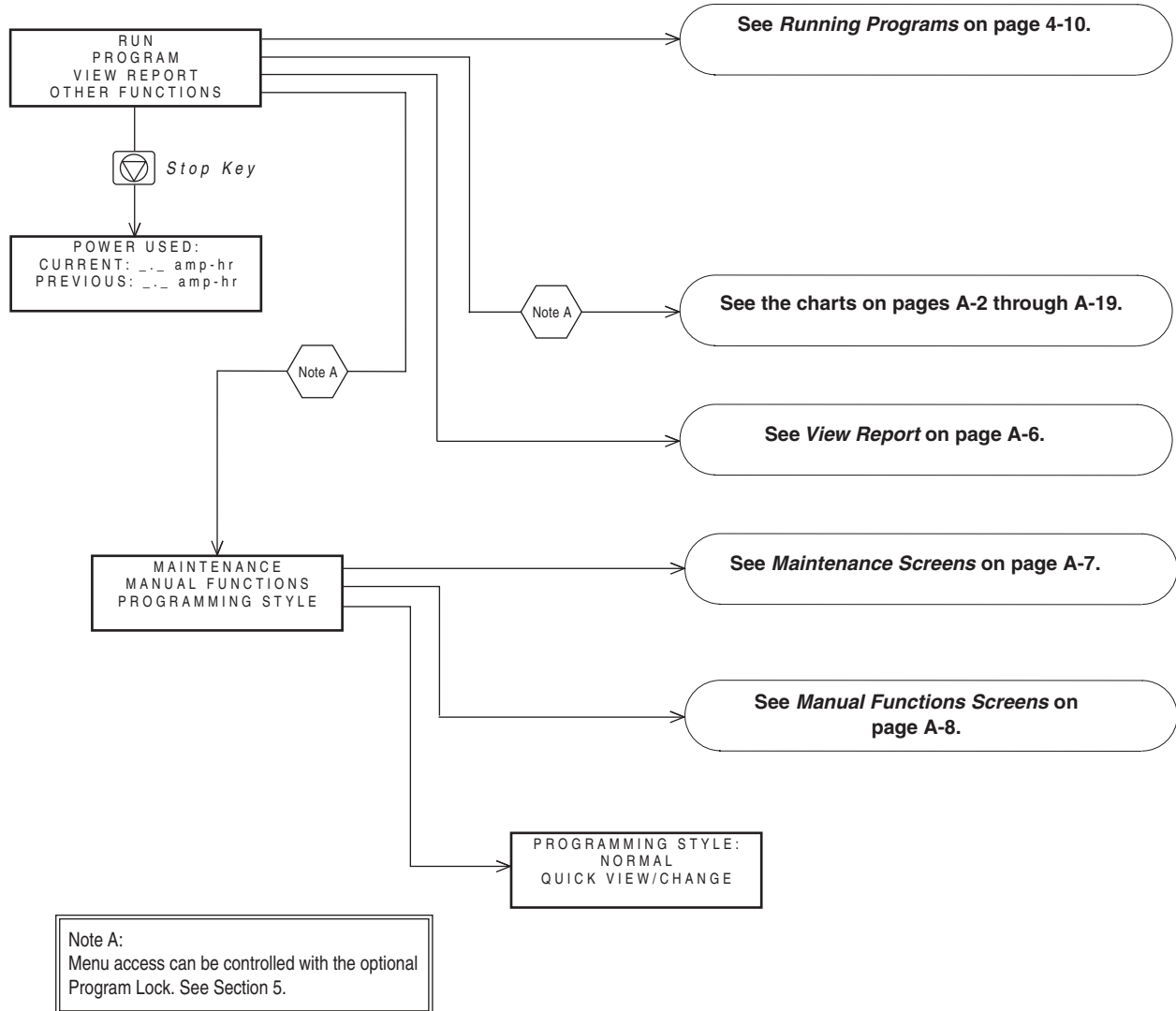

Figure A-1 6712 Menu Tree for Standard Programming

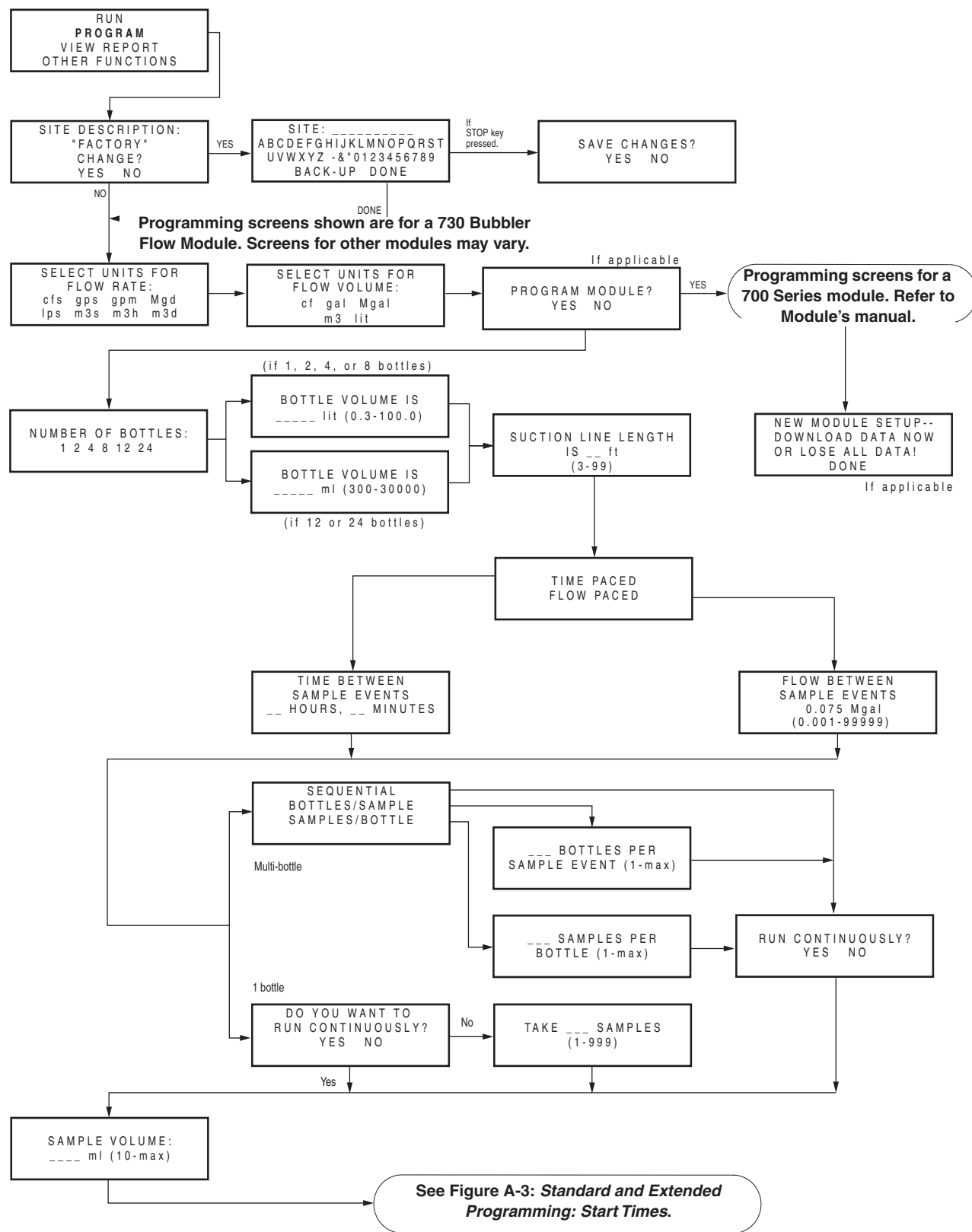
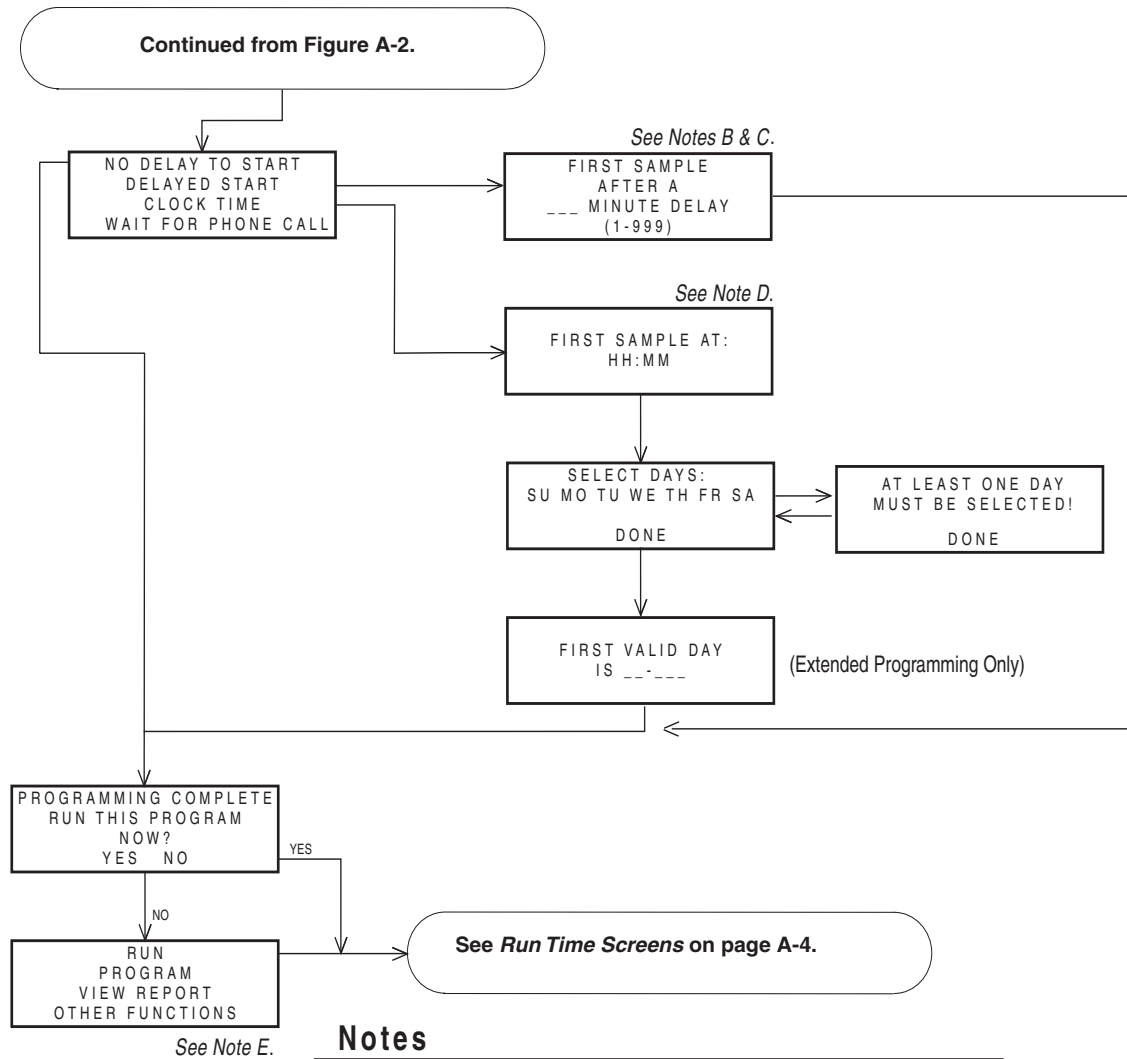

Figure A-2 Standard Programming: Programming Screens



**Notes**

B. Appears for standard flow-paced programs.	START FLOW COUNT AFTER A --- MINUTE DELAY (1-999)
C. Appears for extended programs.	START "EXTENDED 1" AFTER A --- MINUTE DELAY (1-999)
D. Appears for standard flow-paced programs.	START FLOW COUNT AT HH:MM
E. Main menu for extended programming.	RUN "EXTENDED 1" PROGRAM VIEW REPORT OTHER FUNCTIONS

Figure A-3 Standard and Extended Programming: Start Times

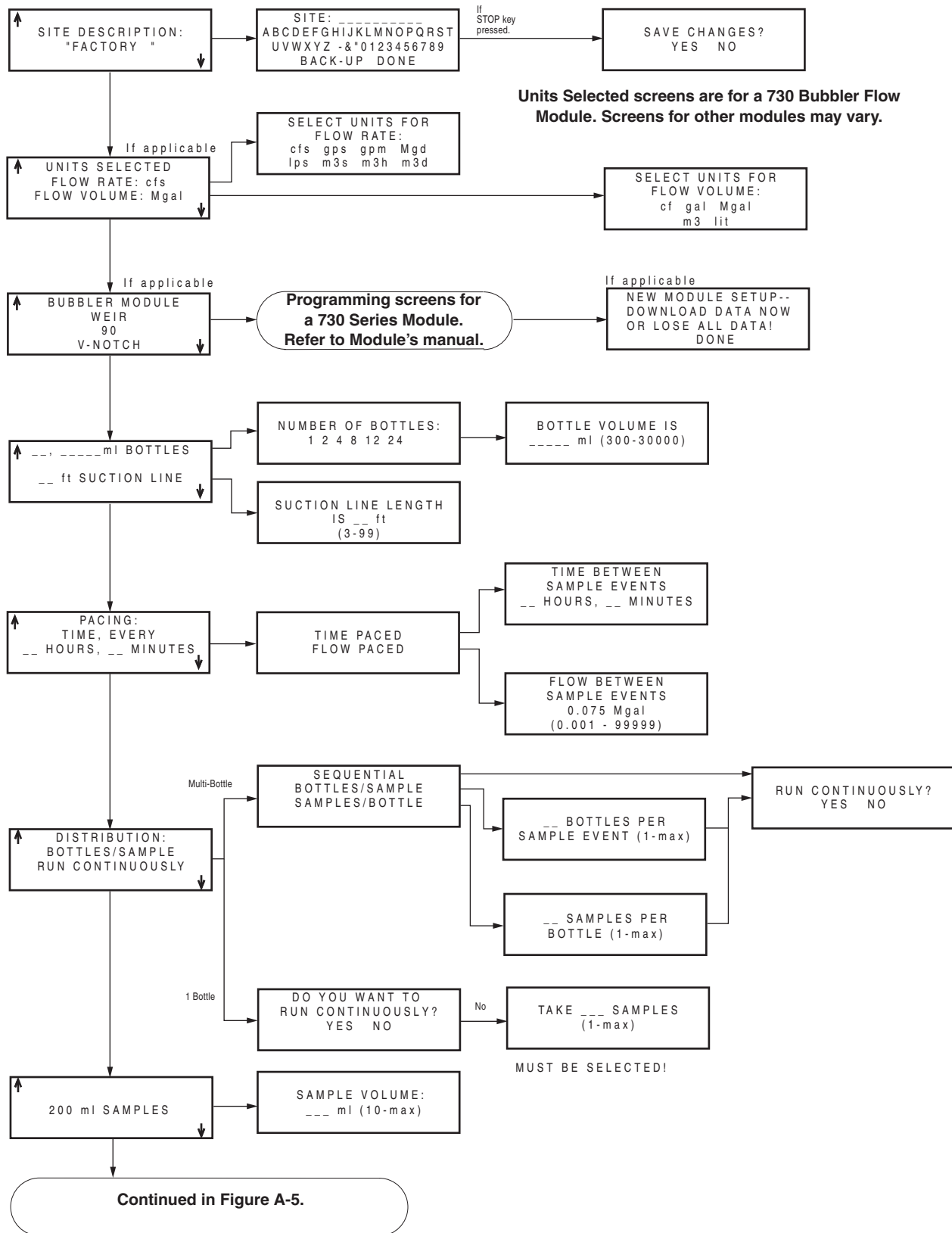

Figure A-4 Standard Programming: Quick View; Programming Screens

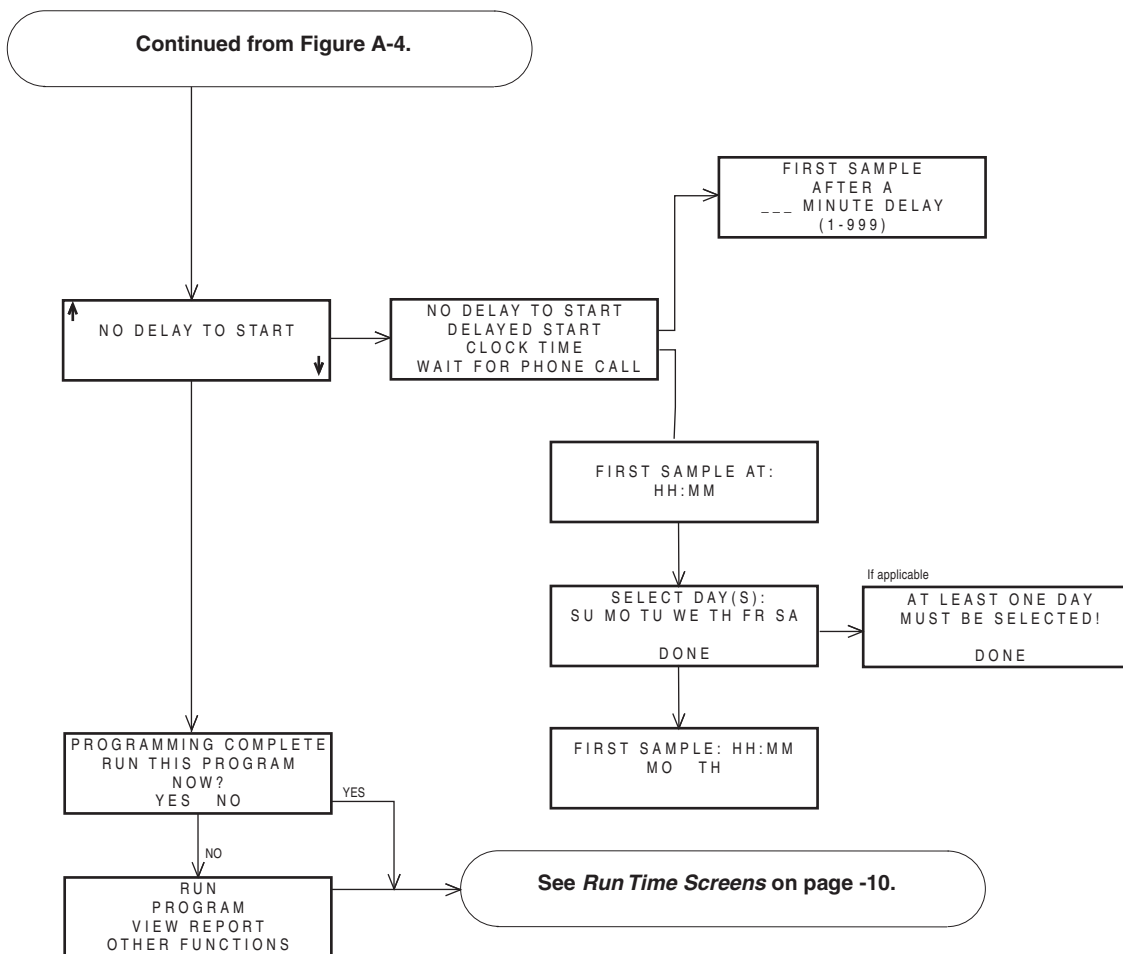

Figure A-5 Standard Programming: Quick View; Start Times

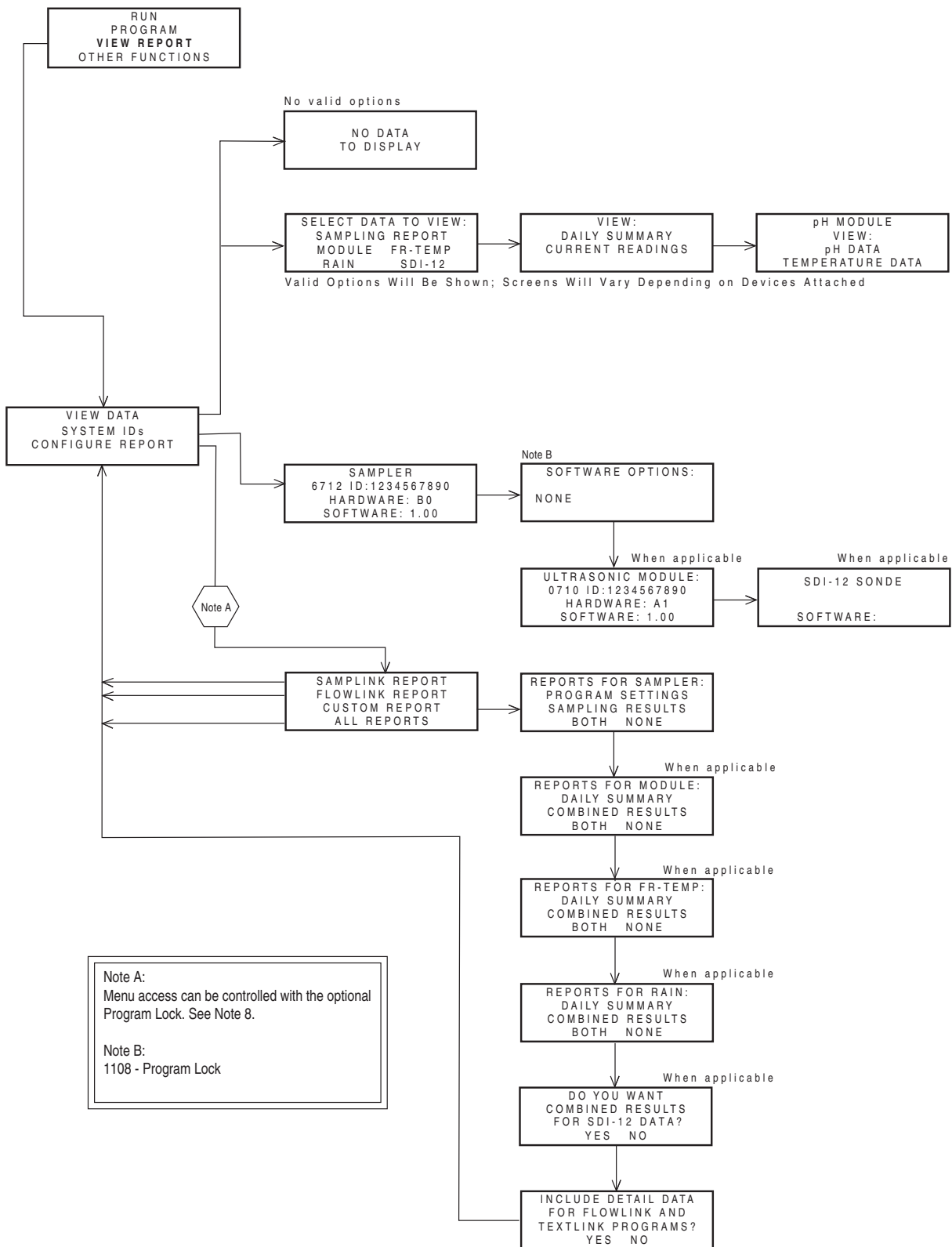
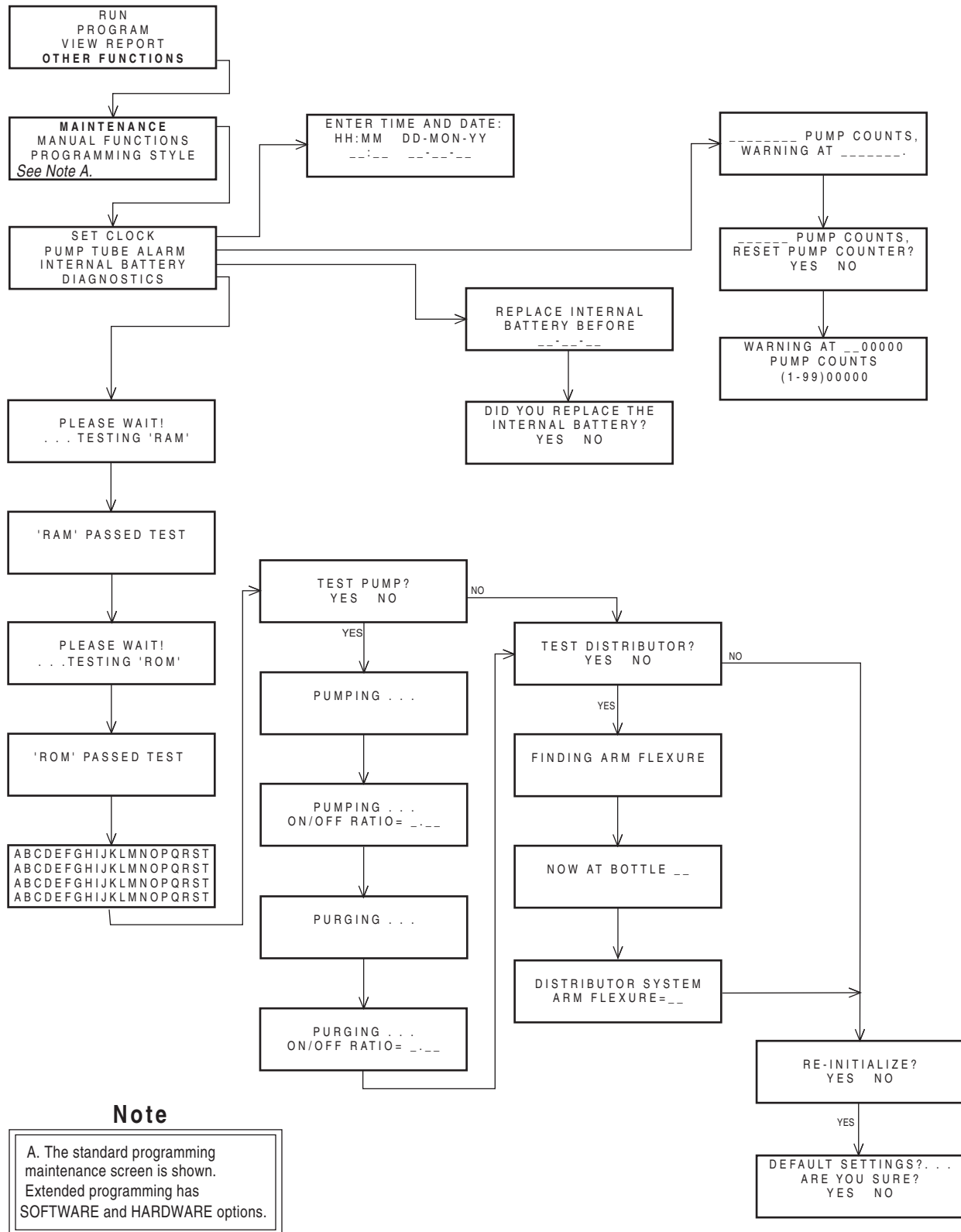

Figure A-6 View Report



**Note**  
A. The standard programming maintenance screen is shown. Extended programming has SOFTWARE and HARDWARE options.

Figure A-7 Maintenance Screens

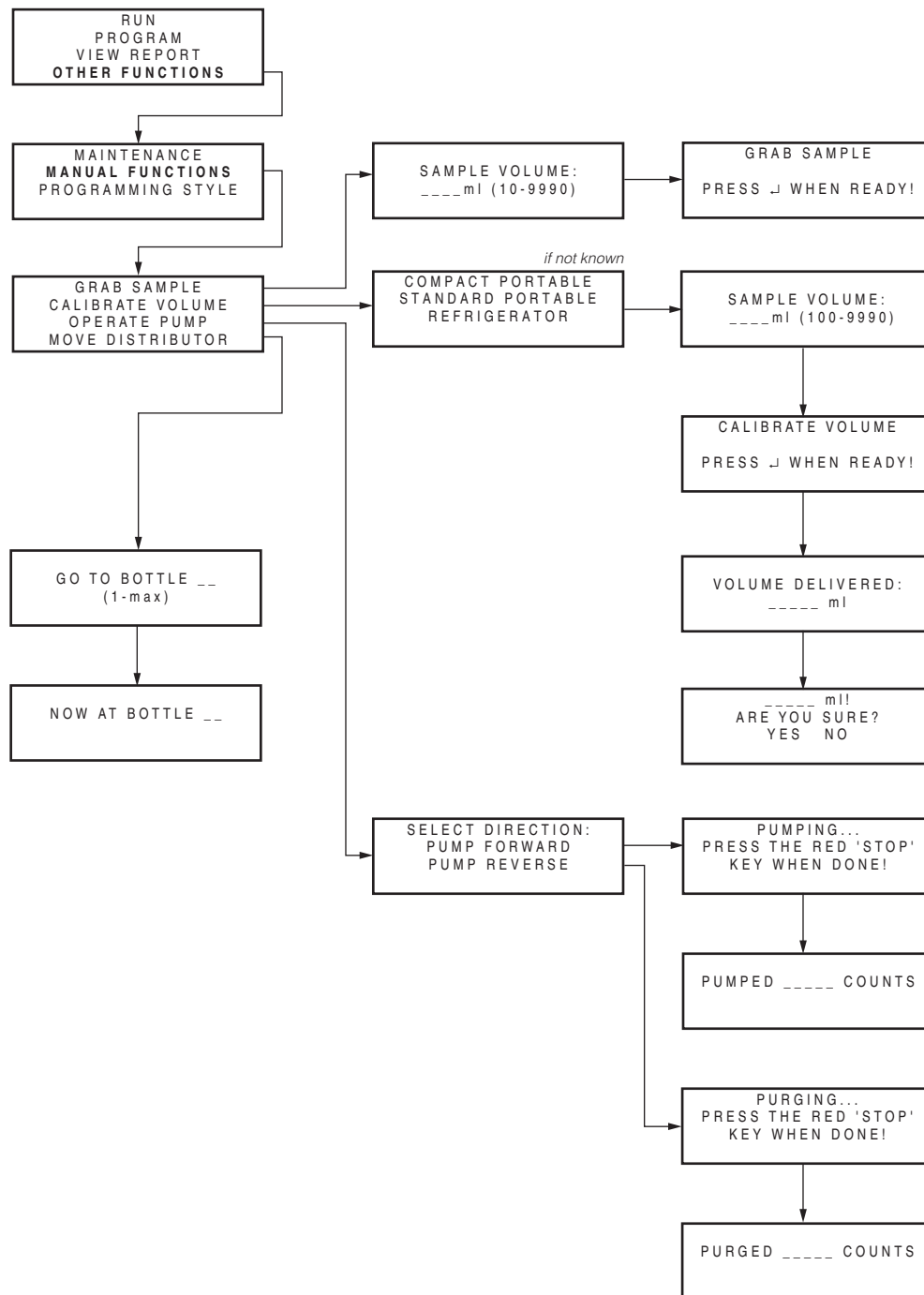

Figure A-8 Manual Functions Screens



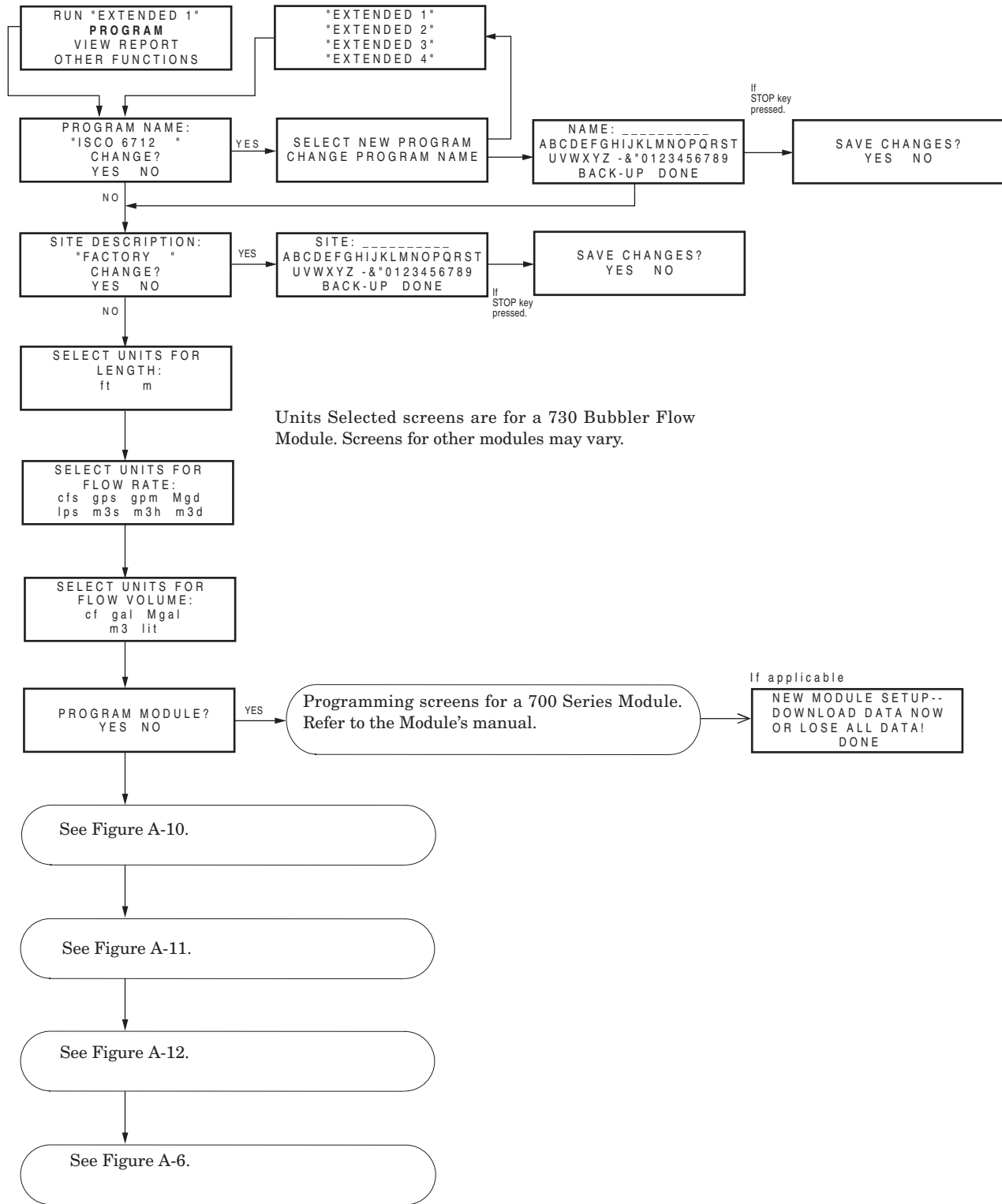

Figure A-9 Extended Programming: Programming Screens

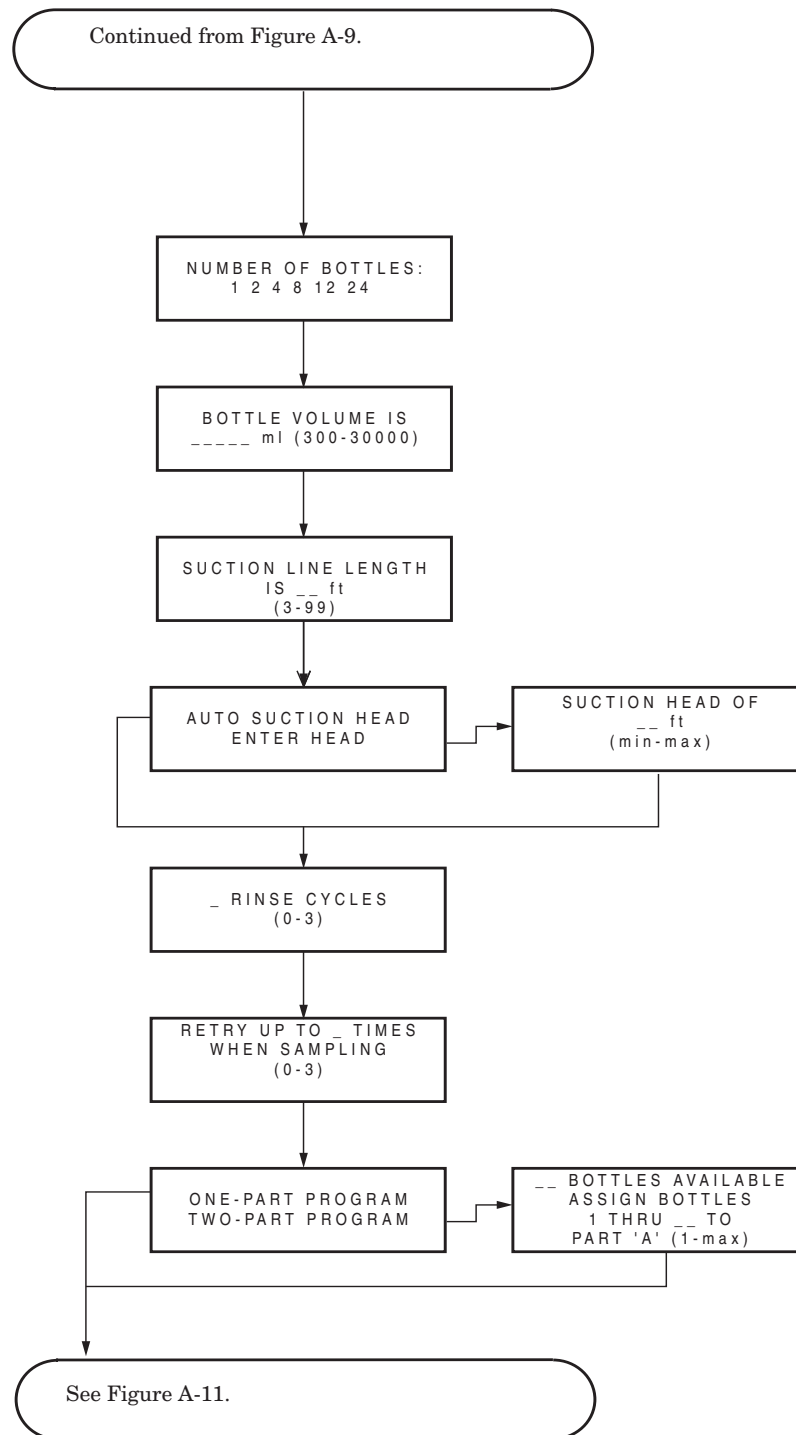

Figure A-10 Extended Programming: Equipment Setup

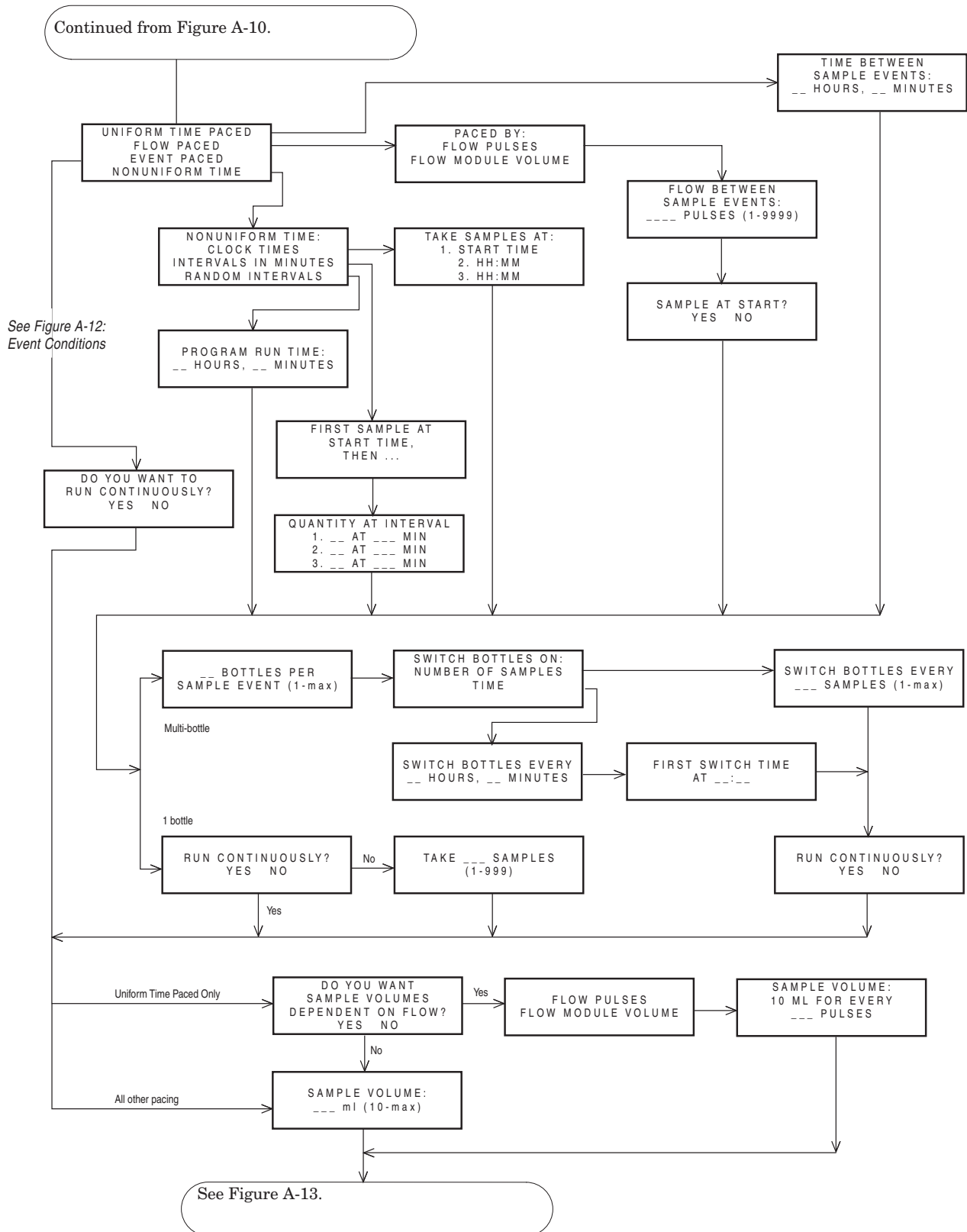

Figure A-11 Extended Programming: Pacing and Distribution

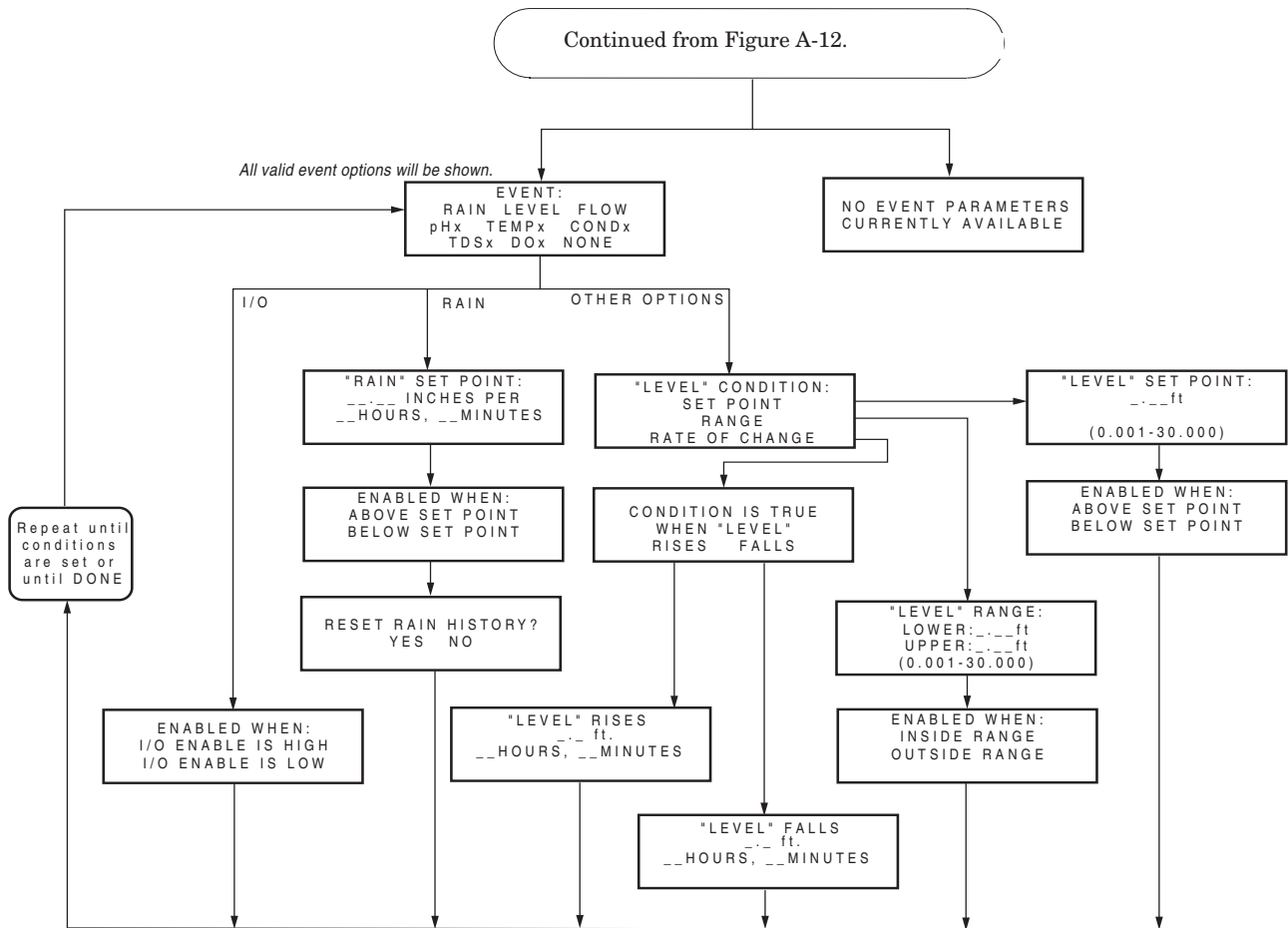

Figure A-12 Extended Programming: Event Conditions

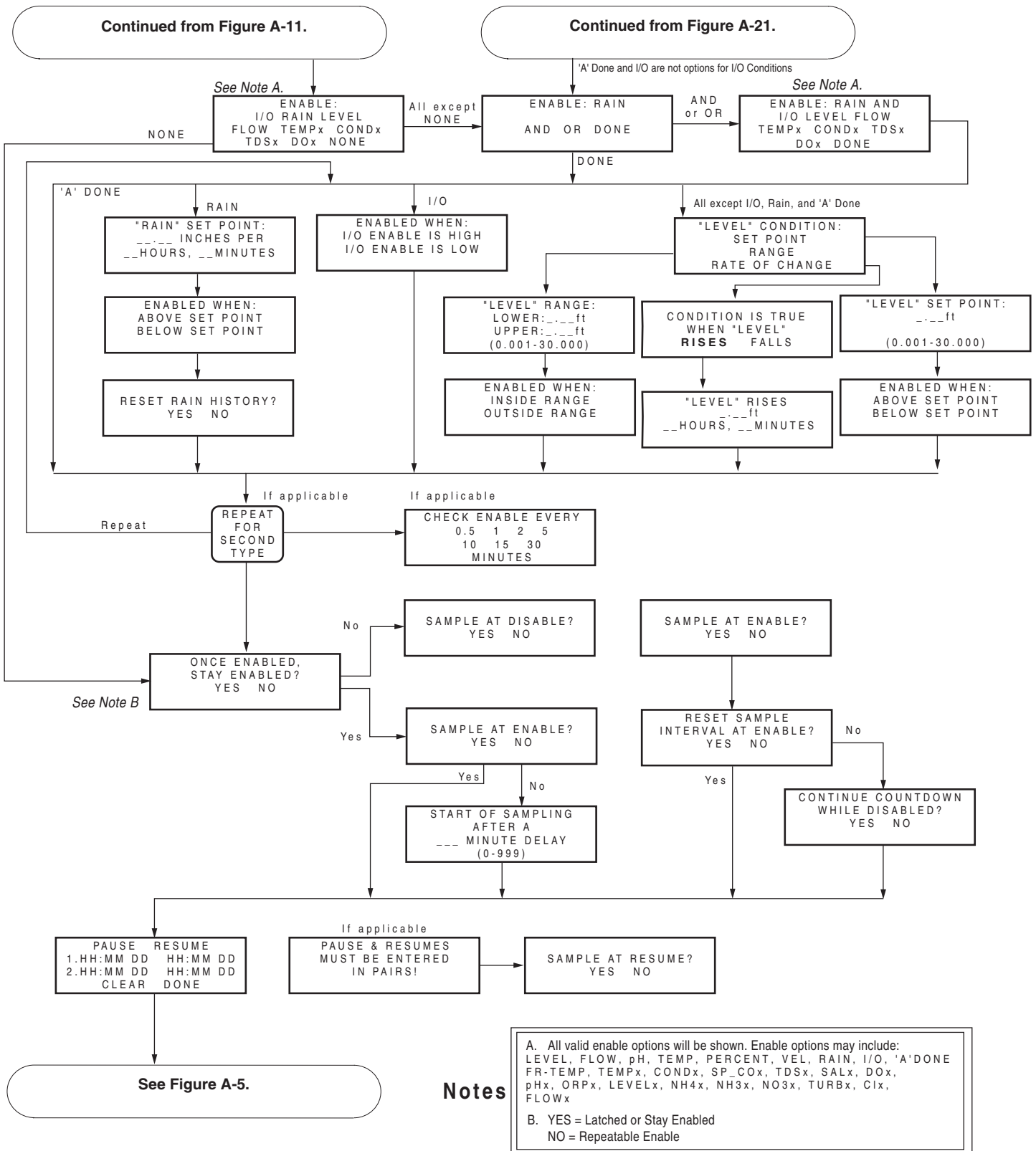

Figure A-13 Extended Programming: Programmed Sampler Enable

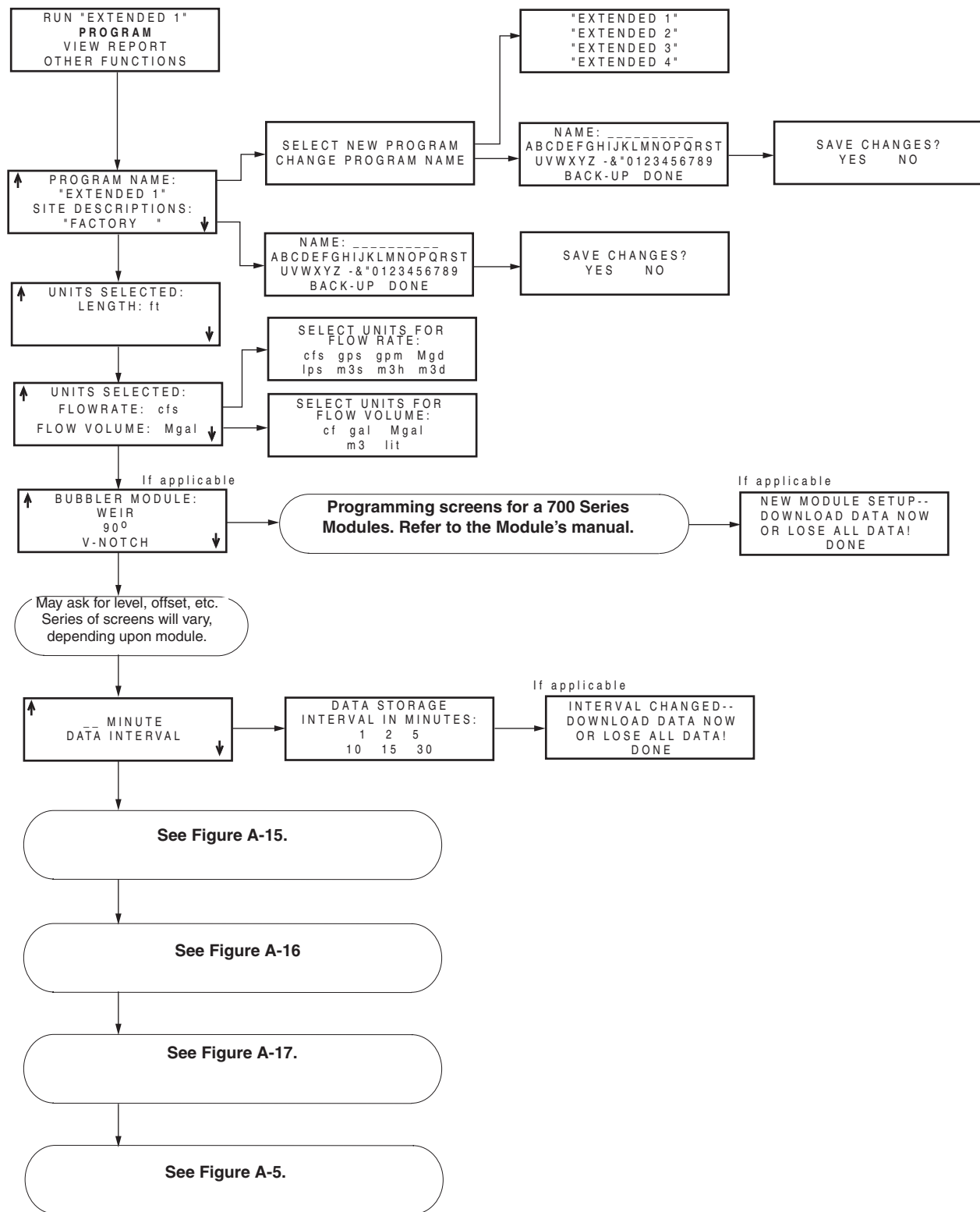

Figure A-14 Extended Programming: Quick View; Programming Screens

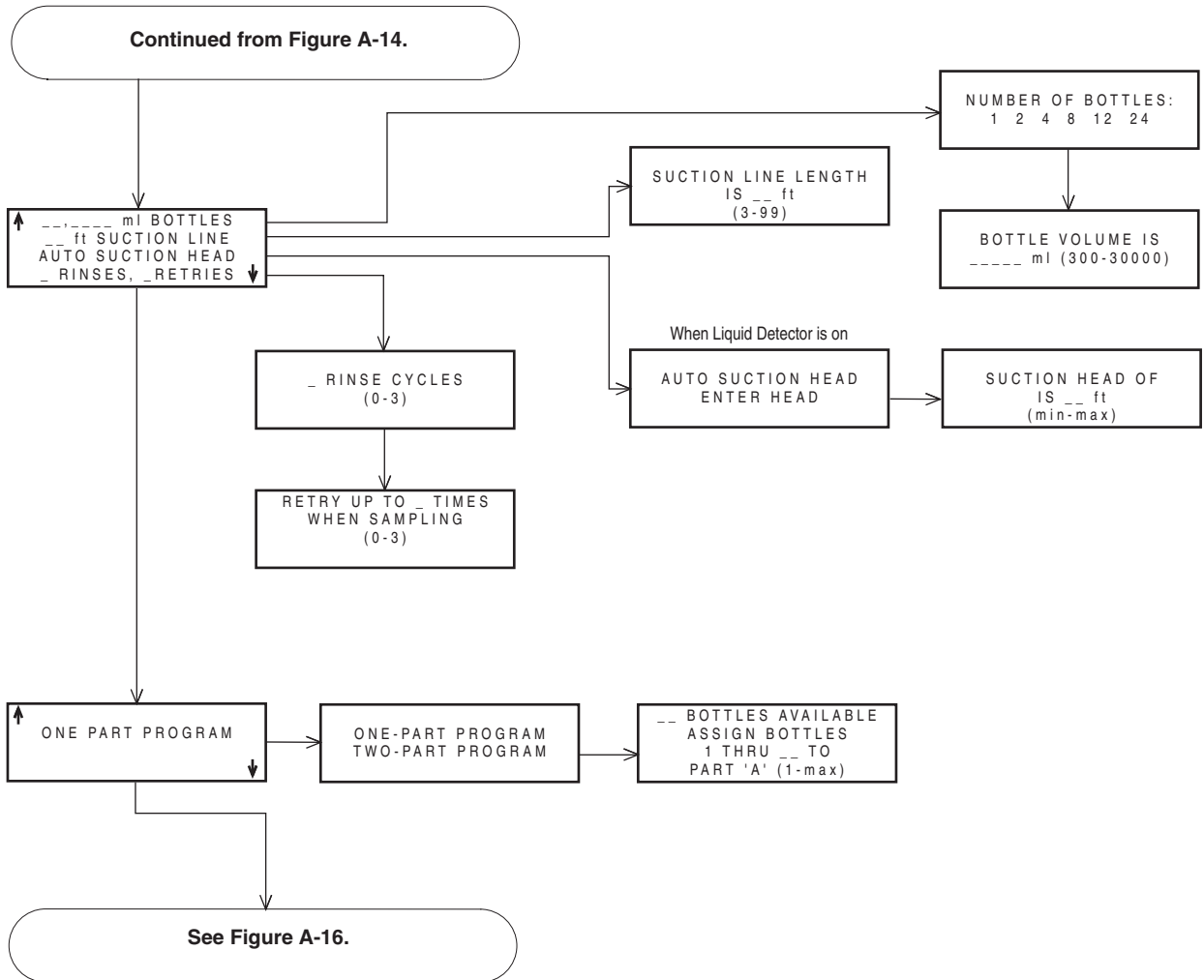

Figure A-15 Extended Programming: Quick View; Equipment Set-Up

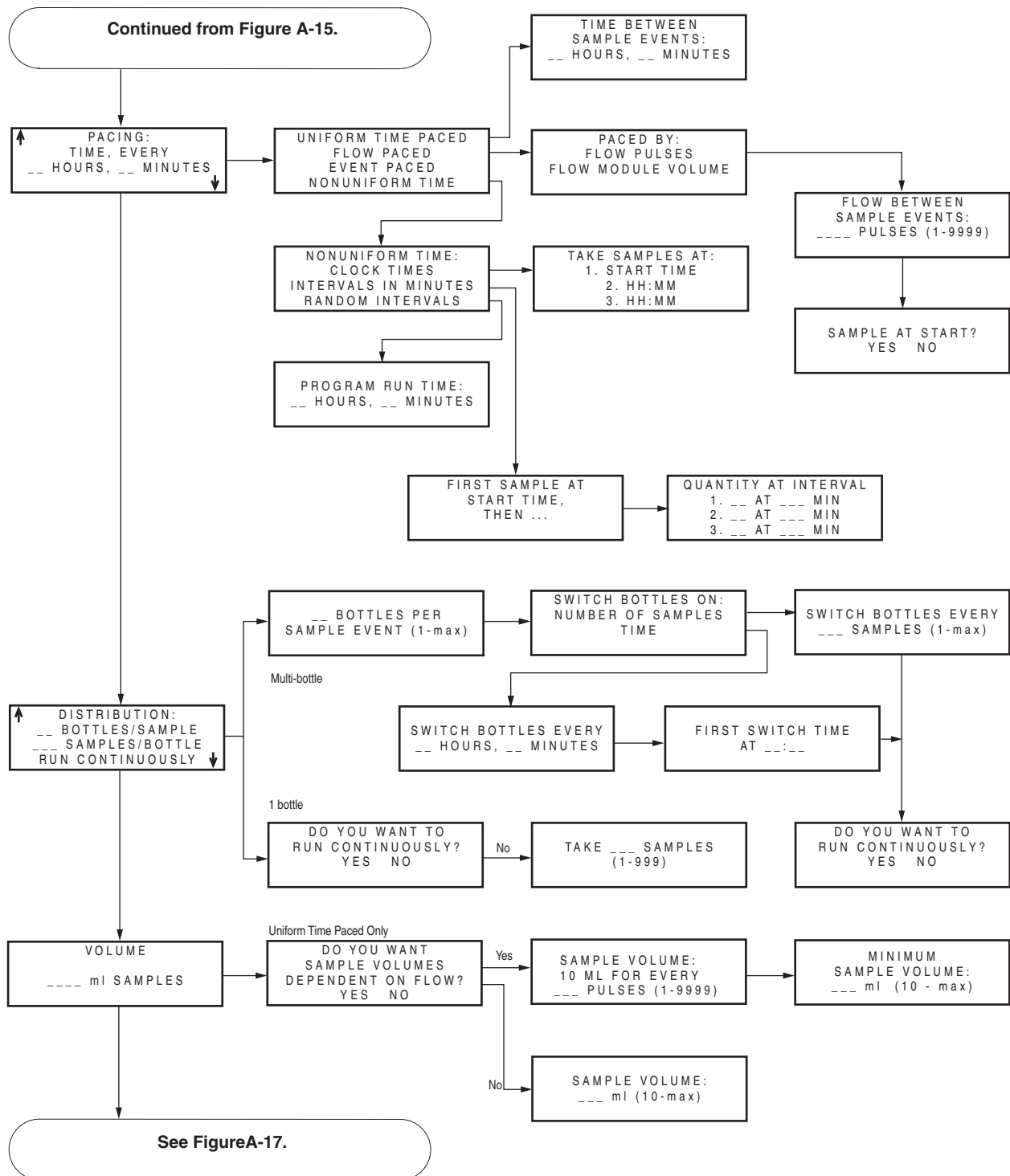

Figure A-16 Extended Programming: Quick View; Pacing and Distribution



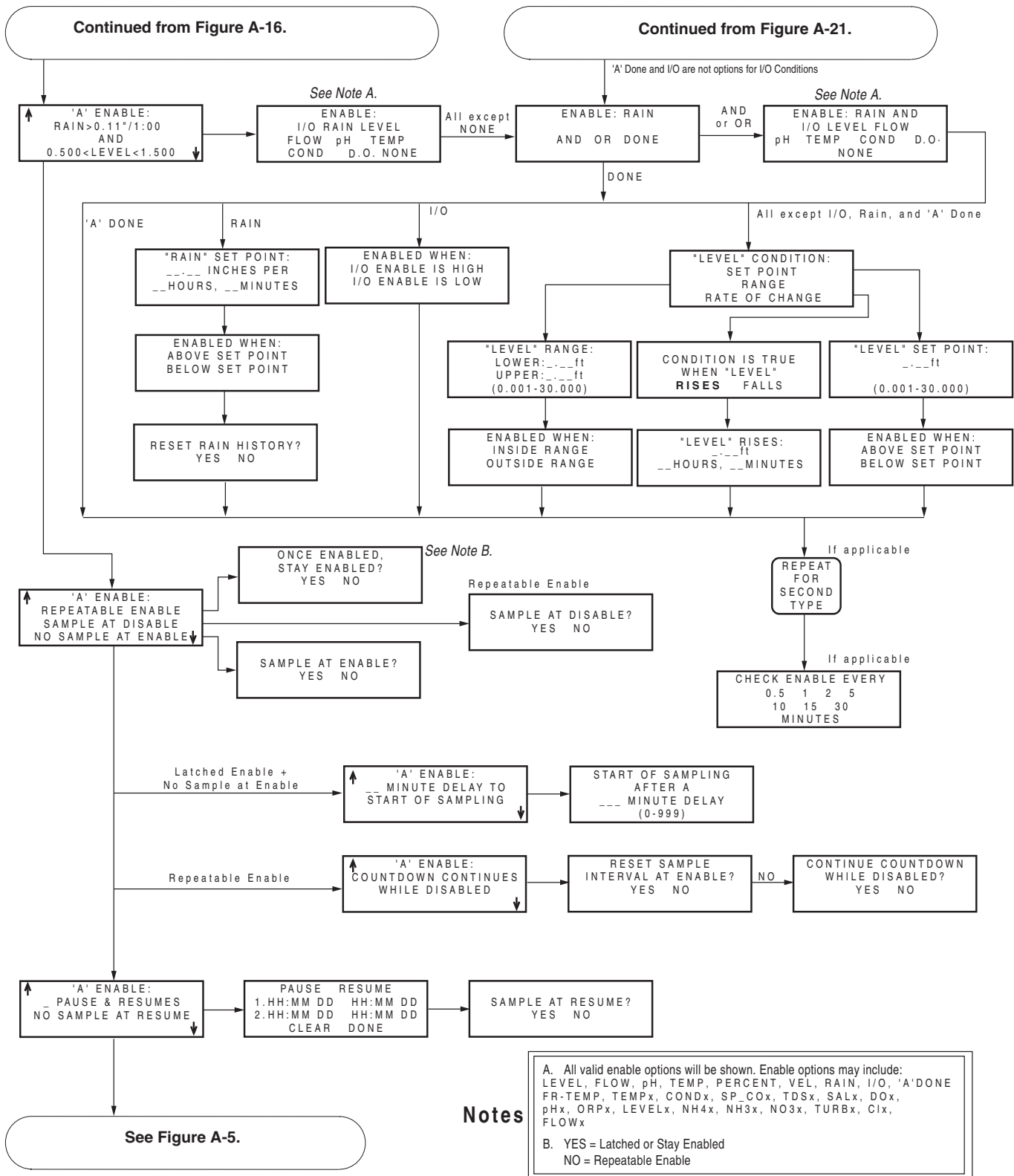

Figure A-17 Extended Programming: Quick View; Programmed Sampler Enable

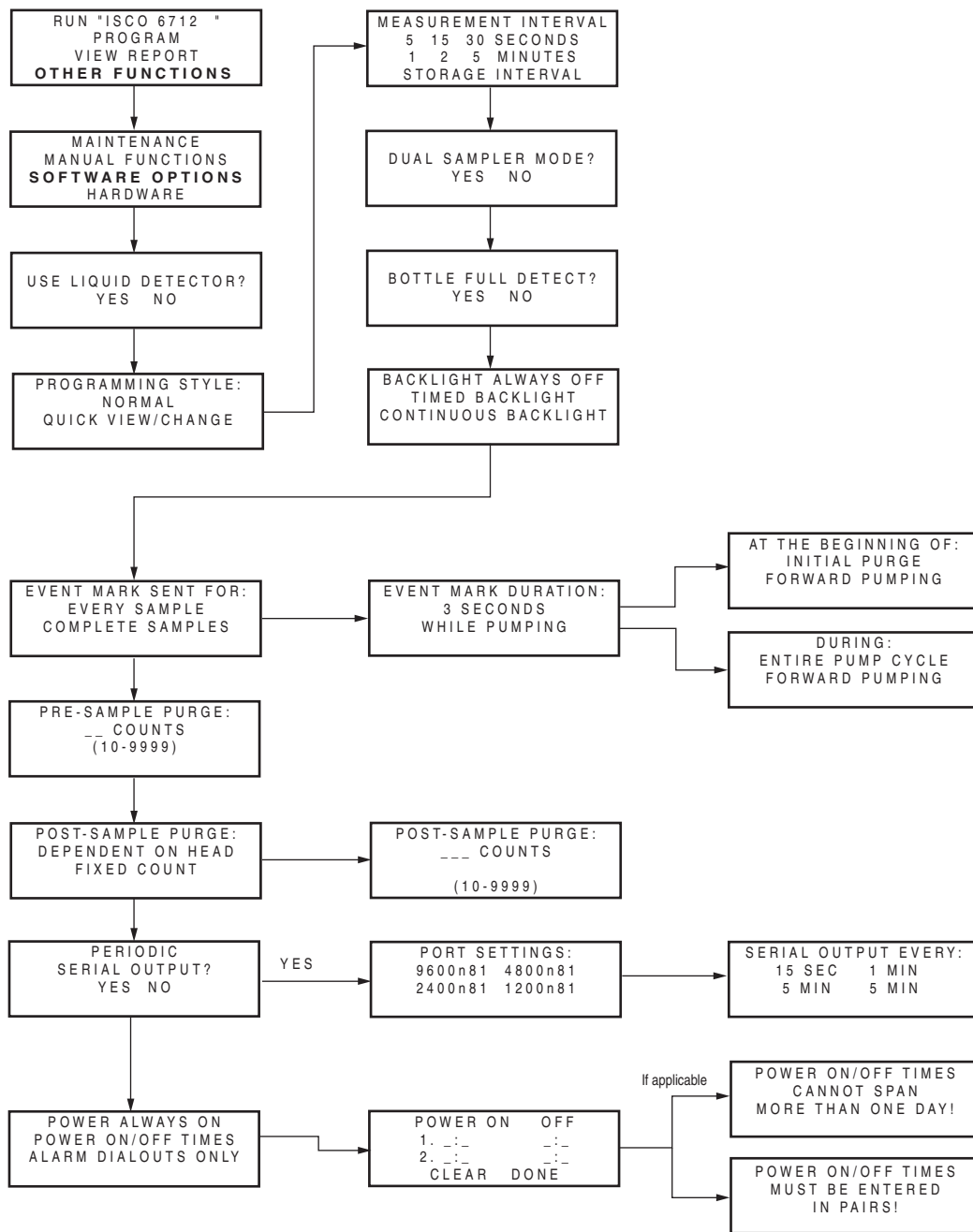

Figure A-18 Extended Programming: Normal View; Software Options

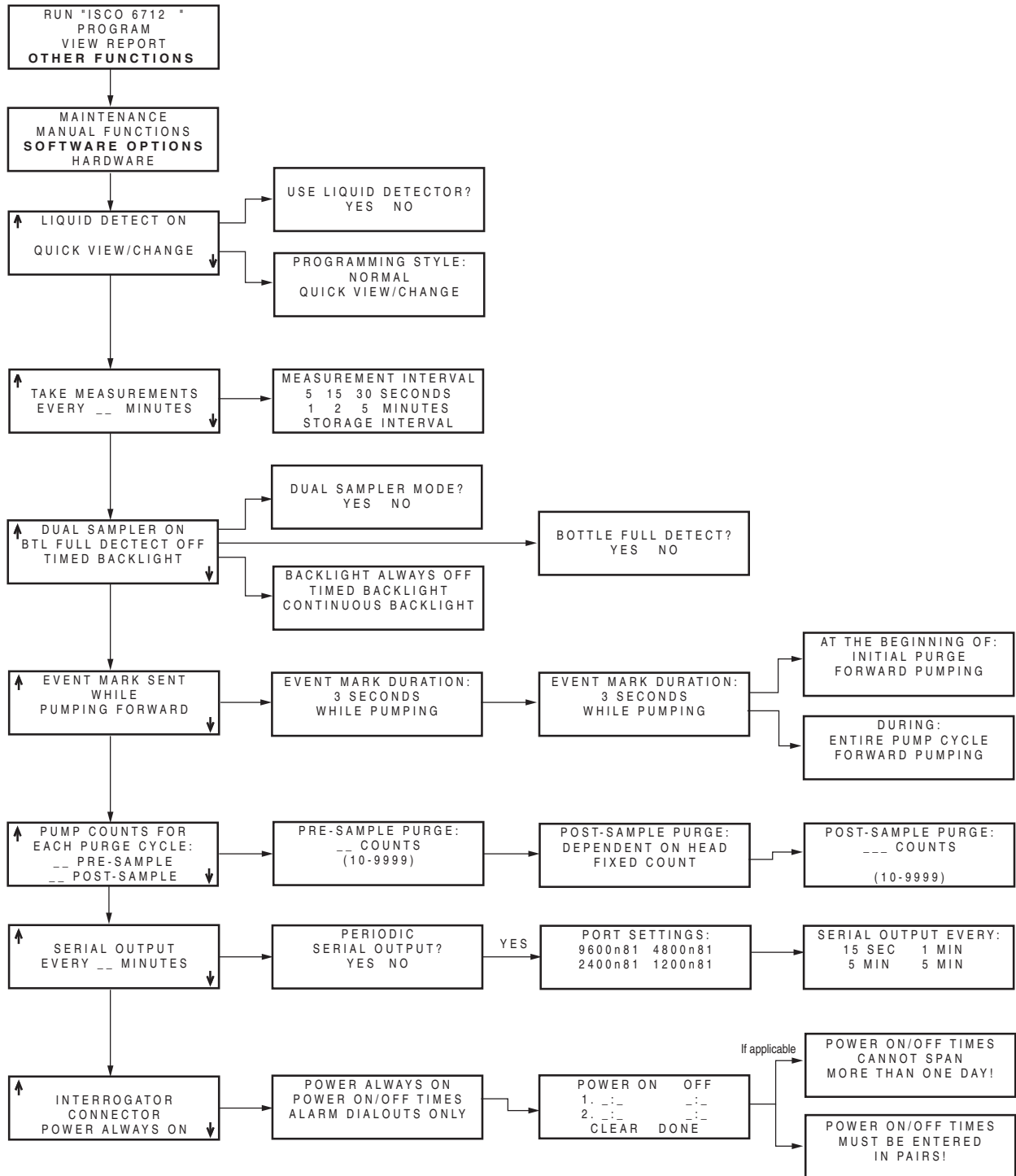

Figure A-19 Extended Programming: Quick View; Software Options

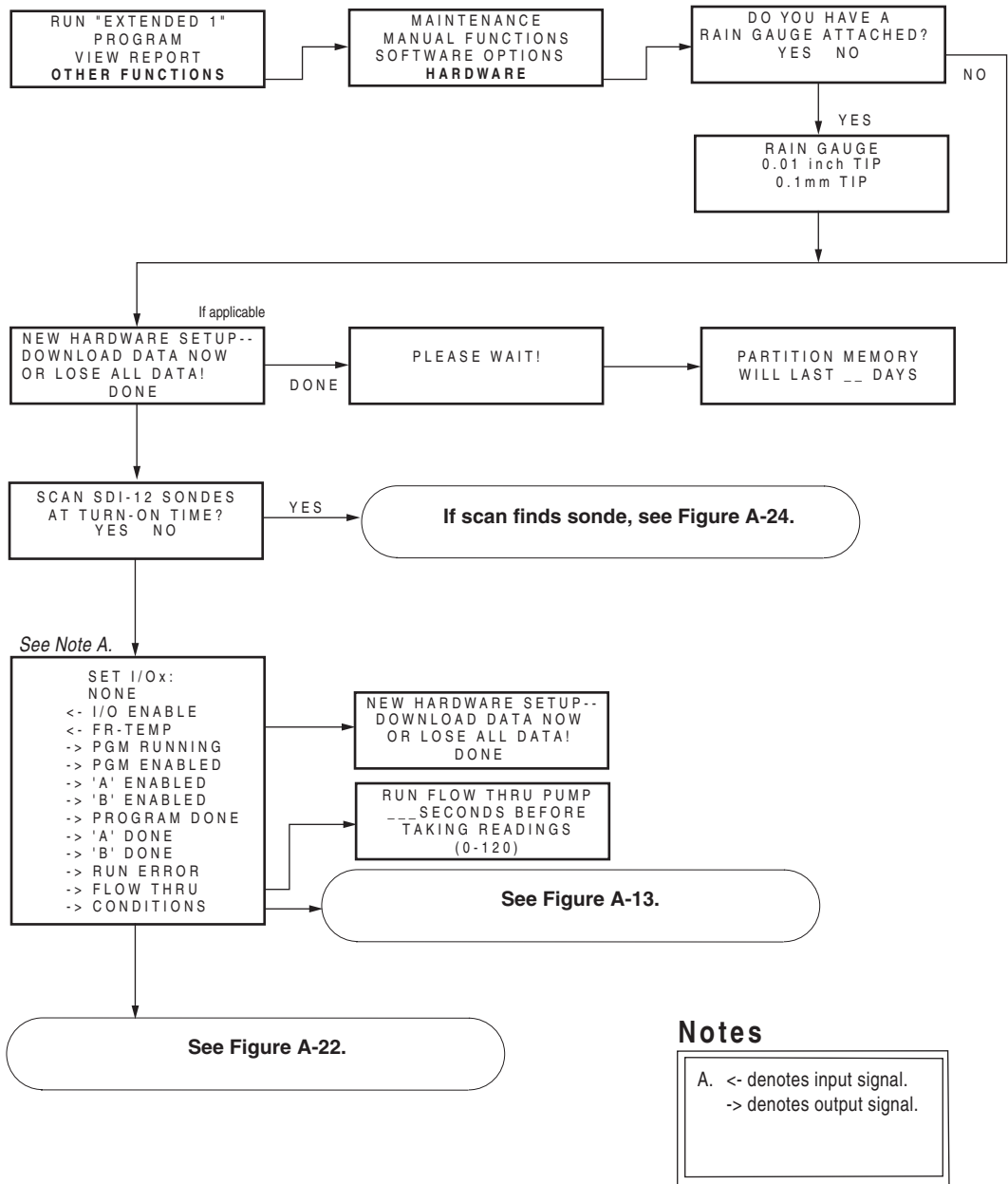

Figure A-20 Extended Programming: Normal View; Hardware

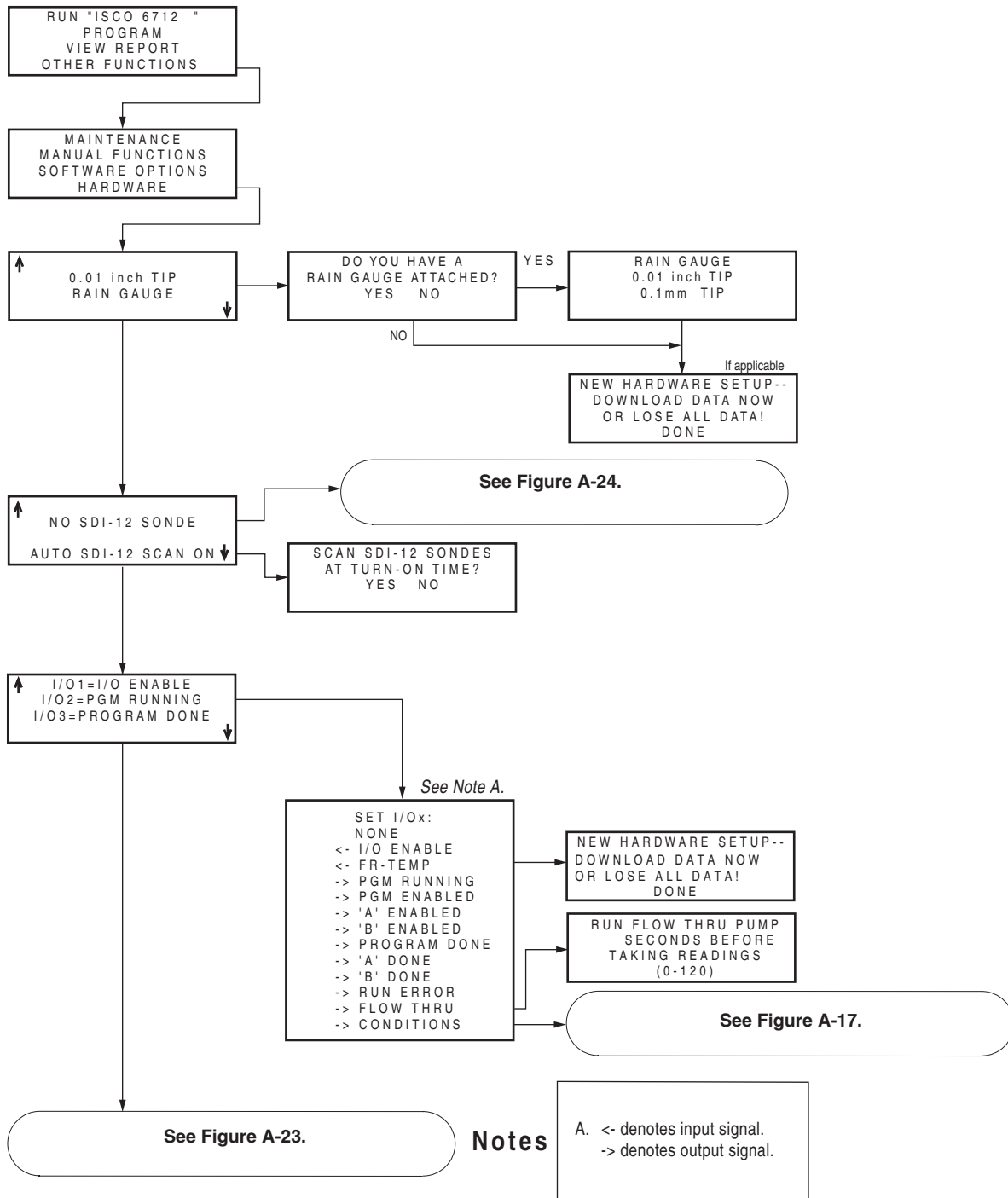

Figure A-21 Extended Programming: Quick View; Hardware

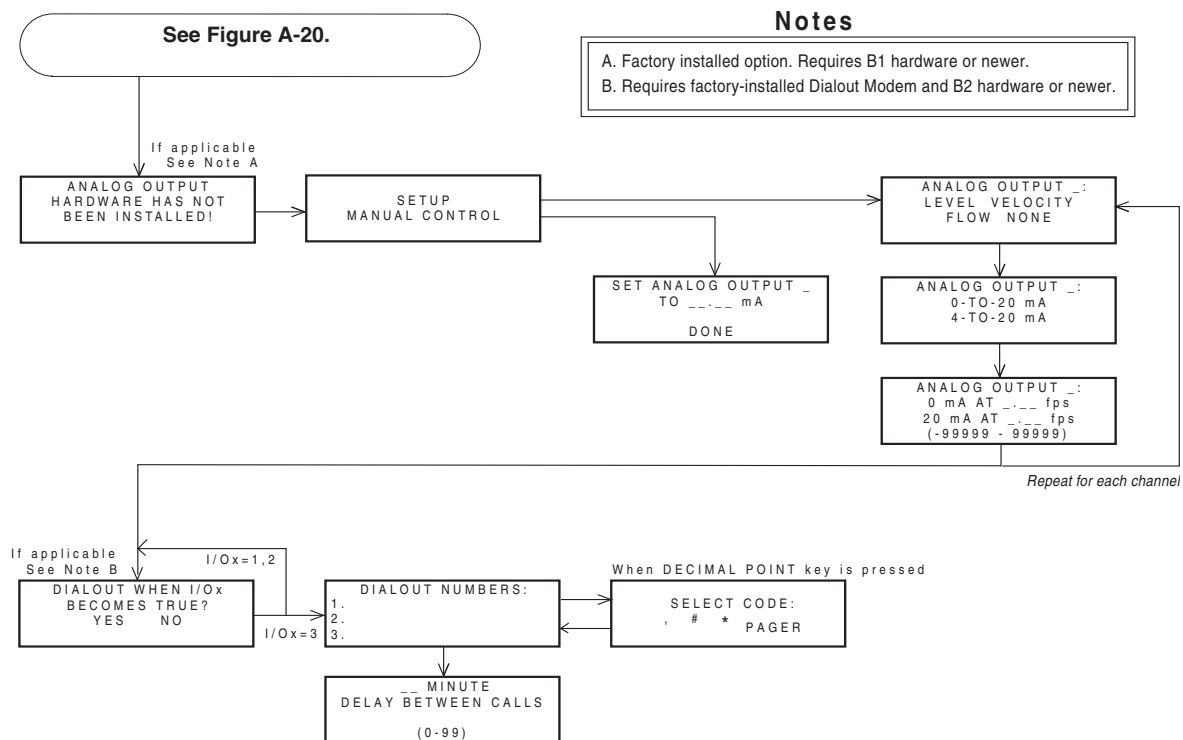

Figure A-22 Analog and Dialout Screens

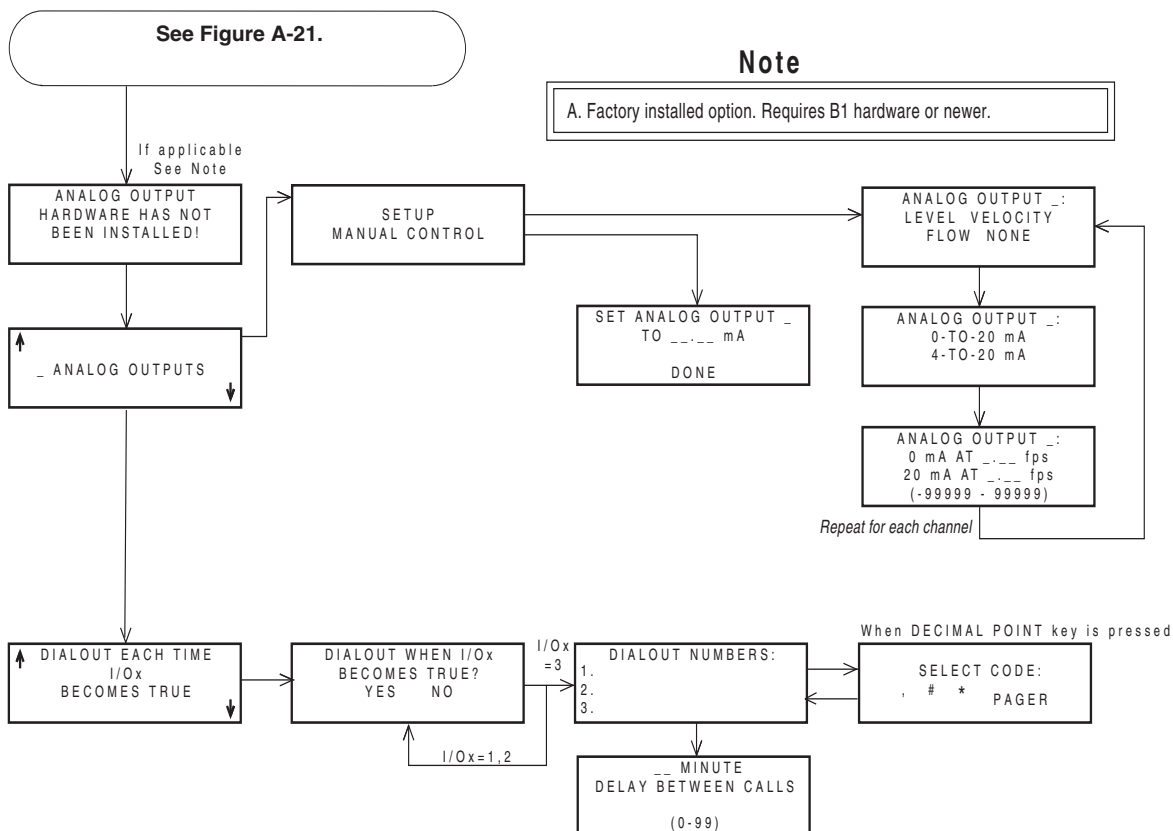

Figure A-23 Analog Output and Dialout Quick View Screens

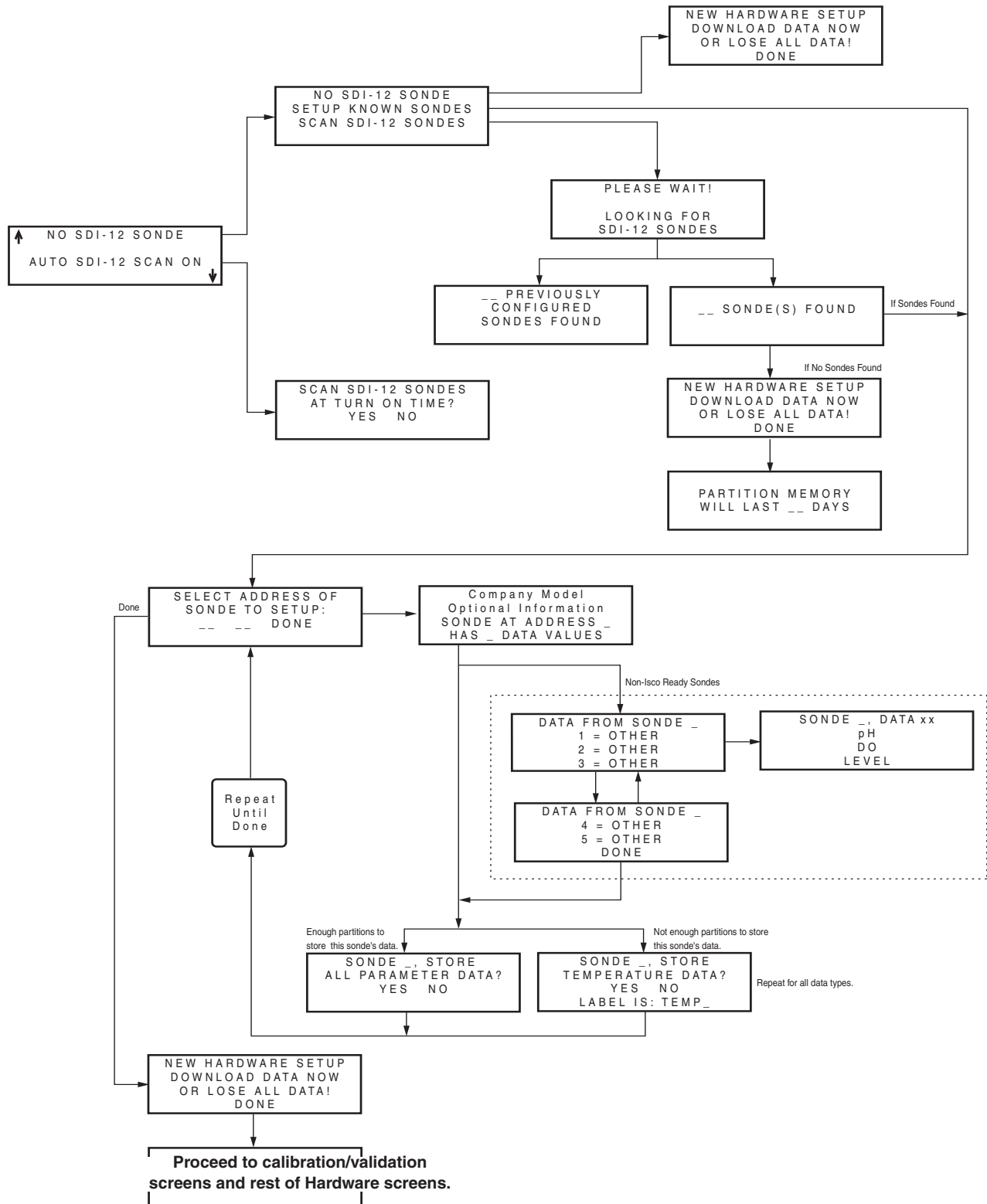

Figure A-24 SDI-12 Sonde Screens





# 6712FR Refrigerated Sampler

---

## *Appendix B Material Safety Data Sheets*

This appendix provides Material Safety Data sheets for the internal desiccant used in the 6712 sampler.

Specific questions regarding the use and handling of these products should be directed to the manufacturer listed in the MSDS.

101 Christine Drive  
Belen, New Mexico 87002  
Phone: (505) 864-6691  
Fax: (505) 861-2355



ISO 9002

---

MATERIAL SAFETY DATA SHEET -- September 28, 1998  
SORB-IT®  
Packaged Desiccant

---

**SECTION I -- PRODUCT IDENTIFICATION**

<b>Trade Name and Synonyms:</b>	Silica Gel, Synthetic Amorphous Silica, Silicon, Dioxide
<b>Chemical Family:</b>	Synthetic Amorphous Silica
<b>Formula:</b>	SiO <sub>2</sub> .x H <sub>2</sub> O

**SECTION II -- HAZARDOUS INGREDIENTS**

Components in the Solid Mixture

COMPONENT	CAS No	%	ACGIH/TLV (PPM)	OSHA-(PEL)
Amorphous Silica	63231-67-4	>99	PEL - 20 (RESPIRABLE), TLV - 5	LIMIT - NONE, HAZARD - IRRITANT "

Synthetic amorphous silica is not to be confused with crystalline silica such as quartz, cristobalite or tridymite or with diatomaceous earth or other naturally occurring forms of amorphous silica that frequently contain crystalline forms.

This product is in granular form and packed in bags for use as a desiccant. Therefore, no exposure to the product is anticipated under normal use of this product. Avoid inhaling desiccant dust.

**SECTION III -- PHYSICAL DATA**

<b>Appearance and Odor:</b>	White granules; odorless.
<b>Melting Point:</b>	>1600 Deg C; >2900 Deg F
<b>Solubility in Water:</b>	Insoluble.
<b>Bulk Density:</b>	>40 lbs./cu. ft.
<b>Percent Volatile by Weight @ 1750 Deg F:</b>	<10%.

101 Christine Drive  
Belen, New Mexico 87002  
Phone: (505) 864-6691  
Fax: (505) 861-2355

**SÜD-CHEMIE**  
Performance Packaging



ISO 9002

---

MATERIAL SAFETY DATA SHEET -- September 28, 1998  
SORB-IT®  
Packaged Desiccant

---

#### SECTION IV -- FIRE EXPLOSION DATA

**Fire and Explosion Hazard** - Negligible fire and explosion hazard when exposed to heat or flame by reaction with incompatible substances.

**Flash Point** - Nonflammable.

**Firefighting Media** - Dry chemical, water spray, or foam. For larger fires, use water spray fog or foam.

**Firefighting** - Nonflammable solids, liquids, or gases: Cool containers that are exposed to flames with water from the side until well after fire is out. For massive fire in enclosed area, use unmanned hose holder or monitor nozzles; if this is impossible, withdraw from area and let fire burn. Withdraw immediately in case of rising sound from venting safety device or any discoloration of the tank due to fire.

#### SECTION V -- HEALTH HAZARD DATA

Health hazards may arise from inhalation, ingestion, and/or contact with the skin and/or eyes. Ingestion may result in damage to throat and esophagus and/or gastrointestinal disorders. Inhalation may cause burning to the upper respiratory tract and/or temporary or permanent lung damage. Prolonged or repeated contact with the skin, in absence of proper hygiene, may cause dryness, irritation, and/or dermatitis. Contact with eye tissue may result in irritation, burns, or conjunctivitis.

**First Aid (Inhalation)** - Remove to fresh air immediately. If breathing has stopped, give artificial respiration. Keep affected person warm and at rest. Get medical attention immediately.

**First Aid (Ingestion)** - If large amounts have been ingested, give emetics to cause vomiting. Stomach siphon may be applied as well. Milk and fatty acids should be avoided. Get medical attention immediately.

**First Aid (Eyes)** - Wash eyes immediately and carefully for 30 minutes with running water.

101 Christine Drive  
Belen, New Mexico 87002  
Phone: (505) 864-6691  
Fax: (505) 861-2355



---

MATERIAL SAFETY DATA SHEET -- September 28, 1998  
SORB-IT®  
Packaged Desiccant

---

**NOTE TO PHYSICIAN:** This product is a desiccant and generates heat as it adsorbs water. The used product can contain material of hazardous nature. Identify that material and treat accordingly.

#### SECTION VI -- REACTIVITY DATA

**Reactivity** - Silica gel is stable under normal temperatures and pressures in sealed containers. Moisture can cause a rise in temperature which may result in a burn.

#### SECTION VII -- SPILL OR LEAK PROCEDURES

Notify safety personnel of spills or leaks. Clean-up personnel need protection against inhalation of dusts or fumes. Eye protection is required. Vacuuming and/or wet methods of cleanup are preferred. Place in appropriate containers for disposal, keeping airborne particulates at a minimum.

#### SECTION VIII -- SPECIAL PROTECTION INFORMATION

**Respiratory Protection** - Provide a NIOSH/MSHA jointly approved respirator in the absence of proper environmental control. Contact your safety equipment supplier for proper mask type.

**Ventilation** - Provide general and/or local exhaust ventilation to keep exposures below the TLV. Ventilation used must be designed to prevent spots of dust accumulation or recycling of dusts.

**Protective Clothing** - Wear protective clothing, including long sleeves and gloves, to prevent repeated or prolonged skin contact.

**Eye Protection** - Chemical splash goggles designed in compliance with OSHA regulations are recommended. Consult your safety equipment supplier.

101 Christine Drive  
Belen, New Mexico 87002  
Phone: (505) 864-6691  
Fax: (505) 861-2355



---

MATERIAL SAFETY DATA SHEET -- September 28, 1998  
SORB-IT®  
Packaged Desiccant

---

**SECTION IX -- SPECIAL PRECAUTIONS**

Avoid breathing dust and prolonged contact with skin. Silica gel dust causes eye irritation and breathing dust may be harmful.

\* No Information Available

HMIS (Hazardous Materials Identification System) for this product is as follows:

Health Hazard	0
Flammability	0
Reactivity	0
Personal Protection	HMIS assigns choice of personal protective equipment to the customer, as the raw material supplier is unfamiliar with the condition of use.

---

The information contained herein is based upon data considered true and accurate. However, United Desiccants makes no warranties expressed or implied, as to the accuracy or adequacy of the information contained herein or the results to be obtained from the use thereof. This information is offered solely for the user's consideration, investigation and verification. Since the use and conditions of use of this information and the material described herein are not within the control of United Desiccants, United Desiccants assumes no responsibility for injury to the user or third persons. The material described herein is sold only pursuant to United Desiccants' Terms and Conditions of Sale, including those limiting warranties and remedies contained therein. It is the responsibility of the user to determine whether any use of the data and information is in accordance with applicable federal, state or local laws and regulations.

# Material Safety Data Sheet

Indicating Silica Gel

Identity (Trade Name as Used on Label)

Manufacturer : MULTISORB TECHNOLOGIES, INC. (formerly Multiform Desiccants, Inc.)	MSDS Number* : M75
Address: 325 Harlem Road Buffalo, NY 14224	CAS Number* :
Phone Number (For Information): 716/824-8900	Date Prepared: July 6, 2000
Emergency Phone Number: 716/824-8900	Prepared By* : G.E. McKedy

## Section 1 - Material Identification and Information

Components - Chemical Name & Common Names (Hazardous Components 1% or greater; Carcinogens 0.1% or greater)	%*	OSHA PEL	ACGIH TLV	OTHER LIMITS RECOMMENDED
Silica Gel SiO <sub>2</sub>	98.0	6mg/m <sup>3</sup> (total dust)	10mg/m <sup>3</sup> (total dust)	
Cobalt Chloride	>2.0	0.05mg/m <sup>3</sup> (TWA cobalt metal dust & fume)	.05mg/m <sup>3</sup> (Cobalt, TWA)	
Non-Hazardous Ingredients				
<b>TOTAL</b>	<b>100</b>			

## Section 2 - Physical/Chemical Characteristics

Boiling Point	N/A	Specific Gravity (H <sub>2</sub> O = 1)	2.1
Vapor Pressure (mm Hg and Temperature)	N/A	Melting Point	N/A
Vapor Density (Air =1)	N/A	Evaporation Rate (_____ =1)	N/A
Solubility in Water	Insoluble, but will adsorb moisture.	Water Reactive	Not reactive, but will adsorb moisture.
Appearance and Odor	Purple crystals, no odor.		

## Section 3 - Fire and Explosion Hazard Data

Flash Point and Methods Used	N/A	Auto-Ignition Temperature	N/A	Flammability Limits in Air % by Volume	N/A	LEL	UEL
Extinguisher Media	Dry chemical, carbon dioxide and foam can be used.						
Special Fire Fighting Procedures	Water will generate heat due to the silica gel which will adsorb water and liberate heat.						
Unusual Fire and Explosion Hazards	When exposed to water, the silica gel can get hot enough to reach the boiling point of water. Flooding with water will reduce the temperature to safe limits.						

## Section 4 - Reactivity Hazard Data

<b>STABILITY</b> <input type="checkbox"/> Stable <input type="checkbox"/> Unstable	Conditions To Avoid	Moisture and high humidity environments.
Incompatibility (Materials to Avoid)	Water.	
Hazardous Decomposition Products	Carbon dioxide, carbon monoxide, water	
<b>HAZARDOUS POLYMERIZATION</b> <input type="checkbox"/> May Occur	Conditions To Avoid	None.

\*Optional

Indicating Silica Gel

**Section 5 - Health Hazard Data**

<b>PRIMARY ROUTES OF ENTRY</b>	<input type="checkbox"/> Inhalation	<input type="checkbox"/> Ingestion	<b>CARCINOGEN LISTED IN</b>	<input type="checkbox"/> NTP	<input type="checkbox"/> OSHA
	<input type="checkbox"/> Skin Absorption	<input type="checkbox"/> Not Hazardous		<input type="checkbox"/> IARC Monograph	<input type="checkbox"/> Not Listed
<b>HEALTH HAZARDS</b>	Acute May cause eye, skin and mucous membrane irritation.				
	Chronic Prolonged inhalation may cause lung damage.				
Signs and Symptoms of Exposure	Drying and irritation.				
Medical Conditions Generally Aggravated by Exposure	Asthma.				
<b>EMERGENCY FIRST AID PROCEDURES</b> - Seek medical assistance for further treatment, observation and support if necessary.					
Eye Contact	Flush with water for at least 15 minutes.				
Skin Contact	Wash affected area with soap and water.				
Inhalation	Remove affected person to fresh air.				
Ingestion	Drink at least 2 glasses of water.				

**Section 6 - Control and Protective Measures**

Respiratory Protection (Specify Type)	Use NIOSH approved dust mask or respirator.				
Protective Gloves	Light cotton gloves.		Eye Protection	Safety glasses.	
<b>VENTILATION TO BE USED</b>	<input type="checkbox"/> Local Exhaust	<input type="checkbox"/> Mechanical (General)	<input type="checkbox"/> Special		
	<input type="checkbox"/> Other (Specify)				
Other Protective Clothing and Equipment	None.				
Hygienic Work Practices	Avoid raising dust. Avoid contact with skin, eyes and clothing.				

**Section 7 - Precautions for Safe Handling and Use/Leak Procedures**

Steps to be Taken if Material Is Spilled Or Released	Sweep or vacuum up and place the spilled material in a waste disposal container. Avoid raising dust.				
Waste Disposal Methods	Dispose in an approved landfill according to federal, state and local regulations.				
Precautions to be Taken In Handling and Storage	Cover promptly to avoid blowing dust. Wash after handling.				
Other Precautions and/or Special Hazards	Keep in sealed containers away from moisture. The silica gel will readily adsorb moisture.				

\*Optional

Indicating Silica Gel





# 6712FR Refrigerated Sampler

## Appendix C General Safety Procedures

In field installations of Isco wastewater samplers and associated equipment, the safety of the personnel involved should be the foremost consideration. The following sections provide safety procedures for working in and around manholes and sewers. The first section offers general safety advice. The second section deals with the special problem of hazardous gases found in sewers.

### WARNING

**The 6712FR has not been approved for use in hazardous locations as defined by the National Electrical Code.**

### CAUTION

Before any sampler is installed, the proper safety precautions must be taken. The following discussions of safety procedures are only general guidelines. Each situation in which you install a flow meter varies. You must take into account the individual circumstances you are in. Additional safety considerations, other than those discussed here, may be required.

## C.1 Practical Safety Precautions

The following procedures are those used by Black & Veatch, a respected consulting firm, and are published here by permission. Field personnel must keep safety uppermost in their minds at all times. When working above ground, rules of common sense and safety prevail. However, when entering manholes, strict safety procedures must be observed. Failure to do so could jeopardize not only your own life, but also the lives of other crew members.

### C.1.1 Hazards

There are many hazards connected with entering manholes. Some of the most common hazards are:

**Adverse Atmosphere** – The manhole may contain flammable or poisonous gases or the atmosphere may be deficient in oxygen. Forced ventilation may be necessary.

**Deteriorated Rungs** – Manhole steps may be corroded and not strong enough to support a man. It may be difficult to inspect the rungs because of poor lighting.

**Traffic** – Whenever manholes are located in the traveled way, barricades and warning devices are essential to direct traffic away from an open manhole.

**Falling Objects** – Items placed near the manhole opening may fall and injure a worker in the manhole.

**Sharp Edges** – Sharp edges of items in or near a manhole may cause cuts or bruises.

**Lifting Injuries** – Unless proper tools are used to remove manhole covers, back injuries or injuries to hands or feet may result.

### C.1.2 Planning

Advance planning should include arrangements for test equipment, tools, ventilating equipment, protective clothing, traffic warning devices, ladders, safety harness, and adequate number of personnel. Hasty actions may result in serious injuries. Time spent in the manhole should be kept to a minimum.

### C.1.3 Adverse Atmospheres

[Refer to Table C-1, Hazardous Gases, at the end of this appendix.] Before workers enter a manhole, tests should be made for explosive atmosphere, presence of hydrogen sulfide, and oxygen deficiency. Combustible or toxic vapors may be heavier than air, so the tests on the atmosphere must be run at least  $\frac{3}{4}$  of the way down the manhole.

Whenever adverse atmosphere is encountered, forced ventilation must be used to create safe conditions. After the ventilating equipment has been operated for a few minutes, the atmosphere in the manhole should be retested before anyone enters the manhole.

When explosive conditions are encountered, the ventilating blower should be placed upwind to prevent igniting any gas that is emerging from the opening. When a gasoline engine blower is used, it must be located so that exhaust fumes cannot enter the manhole.

If testing equipment is not available, the manhole should be assumed to contain an unsafe atmosphere and forced ventilation must be provided. It should never be assumed that a manhole is safe just because there is no odor or the manhole has been entered previously.

### C.1.4 Entering Manholes

Since the top of the manhole is usually flush with the surrounding surface, there may not be anything for the person who is entering the manhole to grab on to steady himself. Persons who are entering manholes should not be permitted to carry anything in their hands as they enter the manhole, to ensure that their hands will be free to hold on or grab if they slip. A good method for entering a manhole is to sit on the surface facing the manhole steps or ladder, with the feet in the hole and the arms straddling the opening for support. As the body slides forward and downward, the feet can engage a rung, and the back can rest against the opposite side of the opening. If there is any doubt about the soundness of the manhole steps, a portable ladder should be used.

A person should never enter a manhole unless he is wearing personal safety equipment, including a safety harness and a hard hat. Two persons should be stationed at the surface continuously while anyone is working inside a manhole, to lift him out if he is

overcome or injured. One man cannot lift an unconscious man out of a manhole. The persons stationed at the surface should also function as guards to keep people and vehicles away from the manhole opening. To avoid a serious injury, a person should not be lifted out of a manhole by his arm unless it is a dire emergency.

When more than one person must enter a manhole, the first person should reach the bottom and step off the ladder before the next one starts down. When two men climb at the same time, the upper one can cause the lower one to fall by slipping or stepping on his fingers.

**C.1.5 Traffic Protection**

In addition to traffic cones, markers, warning signs, and barricades, a vehicle or a heavy piece of equipment should be placed between the working area and oncoming traffic. Flashing warning signals should be used to alert drivers and pedestrians. Orange safety vests should be worn by personnel stationed at the surface when the manhole is located in a vehicular traffic area.

**C.1.6 Falling Objects**

All loose items should be kept away from the manhole opening. This applies to hand tools as well as stones, gravel and other objects.

**C.1.7 Removing the Covers**

Manhole covers should be removed with a properly designed hook. Use of a pick ax, screwdriver, or small pry bar may result in injury. A suitable tool can be made from  $\frac{3}{4}$ -inch round or hex stock. Two inches of one end should be bent at a right angle and the other end should be formed into a D-handle wide enough to accommodate both hands. Even with this tool, care must be exercised to prevent the cover from being dropped on the toes. The 2-inch projection should be inserted into one of the holes in the cover, the handle grasped with both hands, and the cover lifted by straightening the legs which have been slightly bent at the knees.

**C.1.8 Other Precautions**

Other precautions which should be taken when entering a manhole are:

- Wear a hard hat.
- Wear coveralls or removable outer garment that can be readily removed when the work is completed.
- Wear boots or nonsparking safety shoes.
- Wear rubberized or waterproof gloves.
- Wear a safety harness with a stout rope attached.
- Do not smoke.
- Avoid touching yourself above the collar until you have cleaned your hands.

### C.1.9 Emergencies

Every member of the crew should be instructed on procedures to be followed in cases of an emergency. It is the duty of each crew chief to have a list of emergency phone numbers, including the nearest hospital and ambulance service, police precinct, fire station, and rescue or general emergency number.

### C.1.10 Field Equipment

The following equipment will be available for use:

Blowers	Gloves	Traffic cones
Breathing apparatus	Hard Hats	Coveralls
Harnesses	First aid kits	Manhole irons
Emergency flashers	Pick axes	Flashlights
Rain slickers	Mirrors	Ropes
Gas detectors	Safety vests	Gas masks
Waders		

## C.2 Lethal Atmospheres in Sewers

The following is an article written by Dr. Richard D. Pomeroy, and published in the October 1980 issue of *Deeds & Data* of the WPCF. Dr. Pomeroy is particularly well known for his studies, over a period of nearly 50 years, in the field of the control of hydrogen sulfide and other odors in sewers and treatment plants. He has personally worked in a great many functioning sewers. In the earlier years he did so, he admits, with little knowledge of the grave hazards to which he exposed himself.

It is gratifying that the subject of hazards to people working in sewers is receiving much more attention than in past years, and good safety procedures are prescribed in various publications on this subject. It is essential that people know and use correct procedures.

It is less important to know just what the hazardous components of sewer atmospheres are, as safety precautions should in general be broadly applicable, but there should be a reasonable understanding of this subject. It is disturbing to see statements in print that do not reflect true conditions.

One of the most common errors is the assumption that people have died from a lack of oxygen. The human body is able to function very well with substantially reduced oxygen concentrations. No one worries about going to Santa Fe, New Mexico, (elev. 2,100 meters), where the partial pressure of oxygen is equal to 16.2% (a normal atmosphere is about 21%) oxygen. When first going there, a person may experience a little 'shortness of breath' following exercise. People in good health are not afraid to drive over the high passes in the Rocky Mountains. At Loveland Pass, oxygen pressure is 13.2% of a normal atmosphere. At the top of Mt. Whitney, oxygen is equal to 12.2%. Many hikers go there, and to higher peaks as well. After adequate acclimation, they may climb to the top of Mt. Everest, where oxygen is equal to only 6.7%.

The lowest oxygen concentrations that I have observed in a sewer atmosphere was 13 percent. It was in a sealed chamber, near sea level, upstream from an inverted siphon on a metropolitan trunk. A man would be foolish to enter the chamber. Without ventilation, he might die, but not from lack of oxygen.

It seems unlikely that anyone has ever died in a sewer from suffocation, that is, a lack of oxygen. Deaths have often been attributed to 'asphyxiation.' This is a word which, according to the dictionary, is used to mean death from an atmosphere that does not support life. The word has sometimes been misinterpreted as meaning suffocation, which is only one kind of asphyxiation.

In nearly all cases of death in sewers, the real killer is hydrogen sulfide. It is important that this fact be recognized. Many cities diligently test for explosive gases, which is very important, and they may measure the oxygen concentration which usually is unimportant, but they rarely measure  $H_2S$ . Death has occurred where it is unlikely that there was any measurable reduction in the oxygen concentration. Waste water containing 2 mg per liter of dissolved sulfide, and at a pH of 7.0, can produce, in a chamber with high turbulence, a concentration of 300 PPM  $H_2S$ , in the air. This is considered to be a lethal concentration. Many people have died from  $H_2S$ , not only in sewers and industries, but also from swamps and from hot springs. In one resort area, at least five persons died from  $H_2S$  poisoning before the people were ready to admit that  $H_2S$  is not a therapeutic agent. Hardly a year passes in the U.S. without a sewer fatality from  $H_2S$  as well as deaths elsewhere in the world.

The presence of  $H_2S$  in a sewer atmosphere is easily determined. A bellows-and-ampoule type of tester is very satisfactory for the purpose, even though it is only crudely quantitative. When using a tester of this type, do not bring the air to the ampoule by way of a tube, as this may change the  $H_2S$  concentration. Hang the ampoule in the air to be tested, with a suction tube to the bulb or bellows.

Lead acetate paper is very useful as a qualitative indicator. It cannot be used to estimate the amount of sulfide, but it will quickly turn black in an atmosphere containing only a tenth of a lethal concentration.

Electrodes or other similar electrical indicating devices for  $H_2S$  in air have been marketed. Some of them are known to be unreliable, and we know of none that have proved dependable. Do not use one unless you check it at frequent intervals against air containing known  $H_2S$  concentrations. A supposed safety device that is unreliable is worse than none at all.

Remember that the nose fails, too, when it comes to sensing dangerous concentrations of  $H_2S$ .

Various other toxic gases have been mentioned in some publications. It is unlikely that any person has been asphyxiated in a sewer by any of those other gases, except possibly chlorine. The vapor of gasoline and other hydrocarbons is sometimes present in

amounts that could cause discomfort and illness, but under that condition, the explosion hazard would be far more serious. The explosimeter tests, as well as the sense of smell, would warn of the danger. Pipelines in chemical plants might contain any number of harmful vapors. They, too, are sensed by smell and explosimeter tests if they get into the public sewer. Such occurrences are rare.

The attempt to instill a sense of urgency about real hazards is diluted if a man is told to give attention to a long list of things that in fact are irrelevant.

Be very careful to avoid high H<sub>2</sub>S concentrations, flammable atmospheres, and hazards of physical injuries. Remember that much H<sub>2</sub>S may be released by the stirring up of sludge in the bottom of a structure. Obey your senses in respect to irritating gases, such as chlorine (unconsciousness comes suddenly from breathing too much). Be cautious about strange odors. Do not determine percent oxygen in the air. There is a danger that the result will influence a man's thinking about the seriousness of the real hazards. Most important, use ample ventilation, and do not enter a potentially hazardous structure except in a good safety harness with two men at the top who can lift you out."

### C.3 Hazardous Gases

The following table contains information on the properties of hazardous gases.

**Table C-1 Hazardous Gases**

Gas	Chemical Formula	Common Properties	Specific Gravity or Vapor Density Air =1	Physiological Effect	Max Safe 60 Min. Exposure ppm	Max. Safe 8 Hour Exposure ppm	Explosive Range (% by vol. in air) Limits lower/upper	Likely Location of Highest Concentration	Most Common Sources	Simplest and Cheapest Safe Method of Testing
Ammonia	NH <sub>3</sub>	Irritant and poisonous. Colorless with characteristic odor.	0.60	Causes throat and eye irritation at 0.05%, coughing at 0.17%. Short exposure at 0.5% to 1% fatal.	300 to 500	85	16 25	Near top. Concentrates in closed upper spaces	Sewers, chemical feed rooms.	Detectable odor at low concentrations
Benzene	C <sub>6</sub> H <sub>6</sub>	Irritant, colorless anesthetic	2.77	Slight symptoms after several hours exposure at 0.16% to 0.32%. 2% rapidly fatal.	3,000 to 5,000	25	1.3 7.1	At bottom.	Industrial wastes, varnish, solvents.	Combustible gas indicator
Carbon Bisulfide	CS <sub>2</sub>	Nearly odorless when pure, colorless, anesthetic. Poisonous.	2.64	Very poisonous, irritating, vomiting, convulsions, psychic disturbance.	—	15	1.3 44.0	At bottom	An insecticide	Combustible gas indicator

**Table C-1 Hazardous Gases (Continued)**

Gas	Chemical Formula	Common Properties	Specific Gravity or Vapor Density Air =1	Physiological Effect	Max Safe 60 Min. Exposure ppm	Max. Safe 8 Hour Exposure ppm	Explosive Range (% by vol. in air) Limits lower/upper	Likely Location of Highest Concentration	Most Common Sources	Simplest and Cheapest Safe Method of Testing
Carbon Dioxide	CO <sub>2</sub>	Asphyxiant. Colorless, odorless. When breathed in large quantities, may cause acid taste. Non-flammable. Not generally present in dangerous amounts unless an oxygen deficiency exists.	1.53	Cannot be endured at 10% more than a few minutes, even if subject is at rest and oxygen content is normal. Acts on respiratory nerves.	40,000 to 60,000	5,000	— —	At bottom; when heated may stratify at points above bottom.	Products of combustion, sewer gas, sludge. Also issues from carbonaceous strata.	Oxygen deficiency indicator
Carbon Monoxide	CO	Chemical asphyxiant. Colorless, odorless, tasteless. Flammable. Poisonous.	0.97	Combines with hemoglobin of blood. Unconsciousness in 30 min. at 0.2% to 0.25%. Fatal in 4 hours at 0.1%. Headache in few hours at 0.02%.	400	50	12.5 74.0	Near top, especially if present with illuminating gas.	Manufactured gas, flue gas, products of combustion, motor exhausts. Fires of almost any kind.	CO ampoules.
Carbon Tetra-Chloride	CCl <sub>4</sub>	Heavy, ethereal odor.	5.3	Intestinal upset, loss of consciousness, possible renal damage, respiratory failure.	1,000 to 1,500	100	— —	At bottom.	Industrial wastes, solvent, cleaning	Detectable odor at low concentrations.
Chlorine	Cl <sub>2</sub>	Irritant. Yellow-green color. Choking odor detectable in very low concentrations. Non-flammable.	2.49	Irritates respiratory tract. Kills most animals in a very short time at 0.1%.	4	1	— —	At bottom.	Chlorine cylinder and feed line leaks.	Detectable odor at low concentrations.
Formaldehyde	CH <sub>2</sub> O	Colorless, pungent suffocating odor.	1.07	Irritating to the nose.	—	10	7.0 73.0	Near bottom.	Incomplete combustion of organics. Common air pollutant, fungicide.	Detectable odor.
Gasoline	C <sub>5</sub> H <sub>12</sub> to C <sub>9</sub> H <sub>20</sub>	Volatile solvent. Colorless. Odor noticeable at 0.03%. Flammable.	3.0 to 4.0	Anesthetic effects when inhaled. Rapidly fatal at 2.4%. Dangerous for short exposure at 1.1 to 2.2%.	4,000 to 7,000	1,000	1.3 6.0	At bottom.	Service stations, garages, storage tanks, houses.	1. Combustible gas indicator. 2. Oxygen deficiency indicator.**
Hydrogen	H <sub>2</sub>	Simple asphyxiant. Colorless, odorless, tasteless. Flammable	0.07	Acts mechanically to deprive tissues of oxygen. Does not support life.	—	—	4.0 74.0	At top.	Manufactured gas, sludge digestion tank gas, electrolysis of water. Rarely from rock strata.	Combustible gas indicator.
Hydrogen Cyanide	HCN	Faint odor of bitter almonds. Colorless gas	0.93	Slight symptoms appear upon exposure to 0.002% to 0.004%. 0.3% rapidly fatal.	—	10	6.0 40.0	Near top.	Insecticide and rodenticide.	Detector tube



**Table C-1 Hazardous Gases (Continued)**

Gas	Chemical Formula	Common Properties	Specific Gravity or Vapor Density Air = 1	Physiological Effect	Max Safe 60 Min. Exposure ppm	Max. Safe 8 Hour Exposure ppm	Explosive Range (% by vol. in air) Limits lower/upper	Likely Location of Highest Concentration	Most Common Sources	Simplest and Cheapest Safe Method of Testing
Gas	Chemical Formula	Common Properties	Specific Gravity or Vapor Density Air = 1	Physiological Effect*	Max Safe 60 Min. Exposure ppm	Max. Safe 8 Hour Exposure ppm	Explosive Range (% by vol. in air.) Limits lower/upper	Likely Location of Highest Concentration	Most Common Sources	Simplest and Cheapest Safe Method of Testing
Hydrogen Sulfide	H <sub>2</sub> S	Irritant and poisonous volatile compound. Rotten egg odor in small concentrations. Exposure for 2 to 15 min. at 0.01% impairs sense of smell. Odor not evident at high concentrations. Colorless. Flammable.	1.19	Impairs sense of smell, rapidly as concentration increases. Death in few minutes at 0.2%. Exposure to 0.07 to 0.1% rapidly causes acute poisoning. Paralyzes respiratory center.	200 to 300	20	4.3 to 45.0	Near bottom, but may be above bottom if air is heated and highly humid.	Coal gas, petroleum, sewer gas. Fumes from blasting under some conditions. Sludge gas.	1. H <sub>2</sub> S Ampoule. 2. 5% by weight lead acetate solution.
Methane	CH <sub>4</sub>	Simple asphyxiant. Colorless, odorless, tasteless, flammable.	0.55	Acts mechanically to deprive tissues of oxygen. Does not support life.	Probably no limit, provided oxygen percent-age is sufficient for life.	—	5.0 15.0	At top, increasing to certain depth.	Natural gas, sludge gas, manufactured gas, sewer gas. Strata of sedimentary origin. In swamps or marshes.	1. Combustible gas indicator 2. Oxygen deficiency indicator.
Nitrogen	N <sub>2</sub>	Simple asphyxiant. Colorless, tasteless. Non-flammable. Principal constituent of air. (about 79%).	0.97	Physiologically inert.	—	—	— —	Near top, but may be found near bottom.	Sewer gas, sludge gas. Also issues from some rock strata.	Oxygen deficiency indicator.
Nitrogen Oxides	NO	Colorless	1.04	60 to 150 ppm cause irritation and coughing. Asphyxiant. 100 ppm dangerous. 200 ppm fatal.	50	10	— —	Near bottom.	Industrial wastes. Common air pollutant.	NO <sub>2</sub> detector tube.
	N <sub>2</sub> O	Colorless, sweet odor.	1.53							
	NO <sub>2</sub>	Reddish-brown. Irritating odor. Deadly poison	1.58							
Oxygen	O <sub>2</sub>	Colorless, odorless, tasteless. Supports combustion.	1.11	Normal air contains 20.8% of O <sub>2</sub> . Man can tolerate down to 12%. Minimum safe 8 hour exposure, 14 to 16%. Below 10%, dangerous to life. Below 5 to 7% probably fatal.	—	—	— —	Variable at different levels.	Oxygen depletion from poor ventilation and absorption, or chemical consumption of oxygen.	Oxygen deficiency indicator.
Ozone	O <sub>3</sub>	Irritant and poisonous. Strong electrical odor. Strong oxidizer. Colorless. At 1 ppm, strong sulfur-like odor.	1.66	Max. naturally occurring level is 0.04 ppm. 0.05 ppm causes irritation of eyes and nose. 1 to 10 ppm causes headache, nausea; can cause coma. Symptoms similar to radiation damage.	0.08	0.04	— —	Near bottom.	Where ozone is used for disinfection.	Detectable odor at 0.015 ppm.



**Table C-1 Hazardous Gases (Continued)**

Gas	Chemical Formula	Common Properties	Specific Gravity or Vapor Density Air =1	Physiological Effect	Max Safe 60 Min. Exposure ppm	Max. Safe 8 Hour Exposure ppm	Explosive Range (% by vol. in air) Limits lower/upper	Likely Location of Highest Concentration	Most Common Sources	Simplest and Cheapest Safe Method of Testing
Sludge Gas	—***	Mostly a simple asphyxiant. May be practically odorless, tasteless.	Variable	Will not support life.	No data. Would vary widely with composition.		5.3 19.3	Near top of structure.	From digestion of sludge.	See components.
Sulfur Dioxide	SO <sub>2</sub>	Colorless, pungent odor. Suffocating, corrosive, poisonous, non-flammable.	2.26	Inflammation of the eyes. 400 to 500 ppm immediately fatal.	50 to 100	10	— —	At bottom, can combine with water to form sulfurous acid.	Industrial waste, combustion, common air pollutant.	Detectable taste and odor at low concentration.
Toluene	C <sub>5</sub> H <sub>12</sub> to C <sub>9</sub> H <sub>20</sub>	Colorless, benzene-like odor.	3.14	At 200-500 ppm, headache, nausea, bad taste, lassitude.	200	100	1.27 7.0	At bottom.	Solvent.	Combustible gas indicator.
Turpentine	C <sub>10</sub> H <sub>16</sub>	Colorless, Characteristic odor.	4.84	Eye irritation. Headache, dizziness, nausea, irritation of the kidneys.	—	100		At bottom.	Solvent, used in paint.	1. Detectable odor at low concentrations. 2. Combustible gas indicator.
Xylene	C <sub>8</sub> H <sub>10</sub>	Colorless, flammable	3.66	Narcotic in high concentrations. less toxic than benzene.	—	100	1.1 7.0	At bottom.	Solvent	Combustible gas indicator.

\* Percentages shown represent volume of gas in air.

\*\* For concentration over 0.3%.

\*\*\*Mostly methane and carbon dioxide with small amounts of hydrogen, nitrogen, hydrogen sulfide, and oxygen; occasionally traces of carbon monoxide.



# 6712FR Refrigerated Sampler

---

## *Appendix D Replacement Parts List*

### **D.1 Replacement Parts Diagrams and Listings**

Replacement parts are called out in illustrations in this section. Reference the call-outs in the accompanying tables to determine the part number for the item.

Replacement parts can be purchased by contacting Teledyne Isco's Customer Service Department.

#### **Teledyne Isco**

Customer Service Department  
P.O. Box 82531  
Lincoln, NE 68501 USA

Phone: (800) 228-4373  
(402) 464-0231  
FAX:(402) 465-3022

E-mail: [IscoInfo@teledyne.com](mailto:IscoInfo@teledyne.com)

6712FR Refrigerated Sampler  
Appendix D Replacement Parts List

MODEL 6712FR  
REFRIGERATOR ASSEMBLY

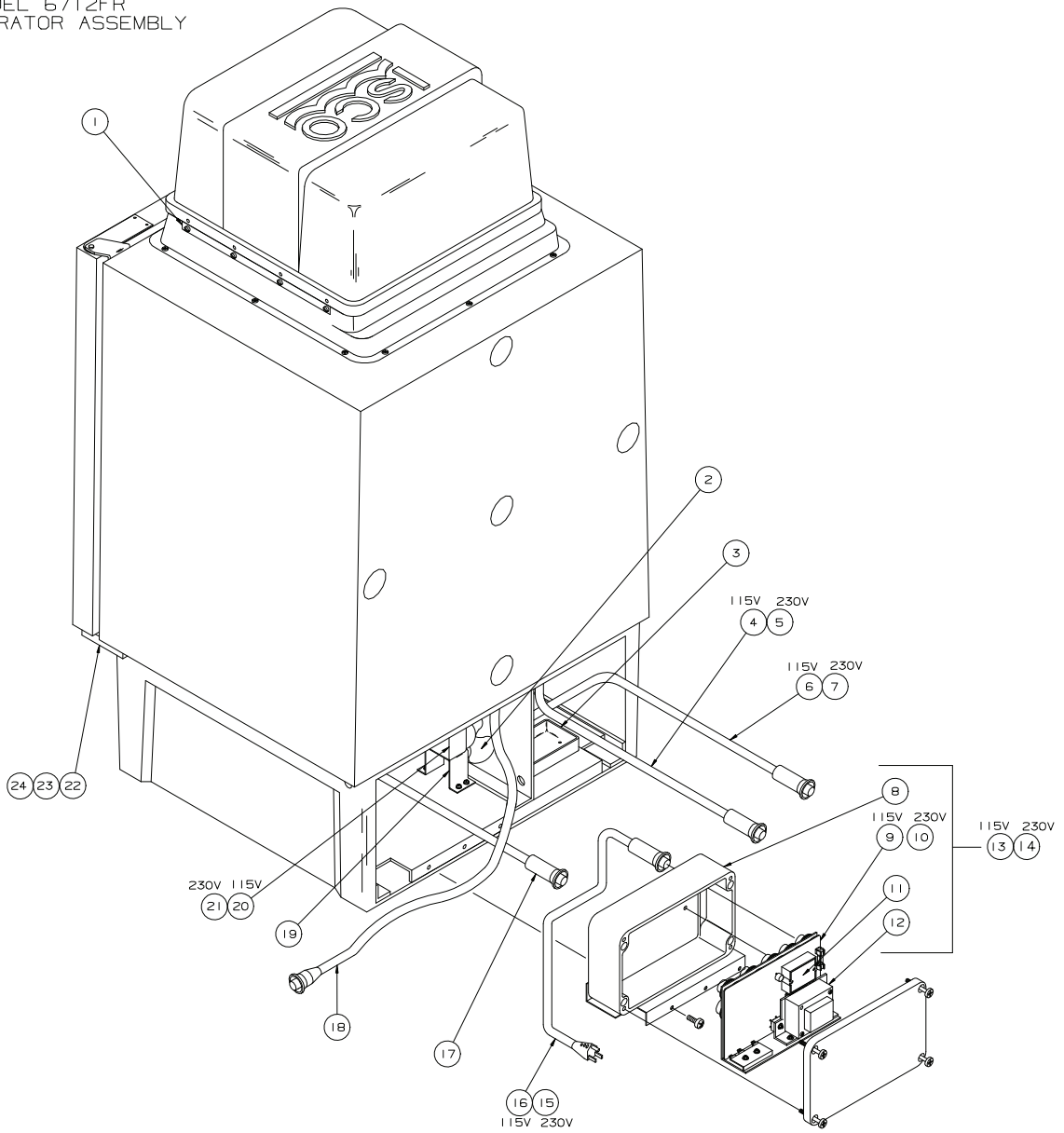

DWG 60-9002-056 REV E

*6712FR Refrigerated Sampler  
Appendix D Replacement Parts List*

ITEM	INVENTORY NO.	DESCRIPTION
1	60-2723-085	COVER HINGE
2	209-0195-03	FAN BLADE
3	60-2723-068	DRIP PAN
4	60-9004-260	EVAPORATOR HEATER ASSY. 115 VAC
5	60-9004-204	EVAPORATOR HEATER ASSY. 230 VAC
6	60-9004-256	CRANKCASE HEATER ASSY. 115 VAC
7	60-9004-228	CRANKCASE HEATER ASSY. 230 VAC
8	60-9003-479	TEMPERATURE CONTROL BOX
9	60-9004-257	PCB ASSY, 115 VAC
10	60-9004-217	PCB ASSY, 230 VAC
11	366-0001-00	SOLID STATE RELAY
12	442-4899-03	TRANSFORMER
13	60-9004-208	TEMPERATURE CONTROL BOX ASSY 115 VAC
14	60-9004-225	TEMPERATURE CONTROL BOX ASSY 230 VAC
15	60-9004-230	LINE CORD ASSY 230 VAC
16	60-9004-242	LINE CORD ASSY 115 VAC
17	60-9004-241	AMBIENT AIR TEMP. SENSOR
18	60-9004-224	SAMPLER POWER WIRING ASSY
19	<b>60-2723-001</b>	FAN MOUNT
20	<b>304-2300-21</b>	MOTOR FAN 115 VAC
21	304-2300-19	MOTOR FAN 230VAC
22	60-2724-066	DOOR HING ASSY BOTTOM
23	231-0149-12	SCREW 1/4-20 X 3/4
24	60-2723-007	HINGE BUSHING
*25	432-0000-00	HEATER FLEX (CRANKCASE) 115 VAC
*+26	<b>432-0000-01</b>	<b>HEATER FLEX (CRANKCASE) 230 VAC.</b>
*27	099-0002-00	DESICCANT (BAG 8 oz)
*28	60-9003-498	REFRIGERATOR BACK COVER
*29	239-0906-32	WELL-NUT FASTNER (FOR AIR TEMP SENSOR)
*30	60-9004-226	AIR TEMP. SENSOR WIRING ASSY
*31	60-9004-240	EVAP. TEMP. SENSOR
*32	<b>60-2723-002</b>	FAN SHROUD MOUNT
*33	210-0003-01	COMPRESSOR 600 BTU/hr 115VAC
*++34	<b>210-0001-10</b>	<b>COMPRESSOR 920 BTU/HR 230 VAC.</b>
*35	210-0003-02	OVERLOAD FOR COMPRESSOR 115 VAC
*+36	<b>210-0001-08</b>	<b>OVERLOAD FOR COMPRESSOR 230VAC.</b>
*37	210-0003-03	RELAY FOR COMPRESSOR 115 VAC
*++38	<b>210-0001-07</b>	<b>RELAY FOR COMPRESSOR 230VAC.</b>
*+39	61-2724-059	CONDENSING COIL 120VAC/230VAC. 230VAC SERIALS PRIOR TO 216M
*++40	60-9004-010	CONDENSING COIL 230VAC.
*++41	210-0002-08	OVERLOAD FOR COMPRESSOR 230VAC.
*++42	60-9004-033	CAPACITOR AND RELAY ASSEMBLY 230VAC.

NOTE: \* ITEM IS NOT SHOWN IN ILLUSTRATION.  
 + ITEM IS FOR SERIAL NUMBERS PRIOR TO 216M.  
 ++ ITEM IS FOR SERIAL NUMBERS 216M OR LATER.

6712FR Refrigerated Sampler  
 Appendix D Replacement Parts List

MODEL 6712FR  
 REFRIGERATOR ASSEMBLY

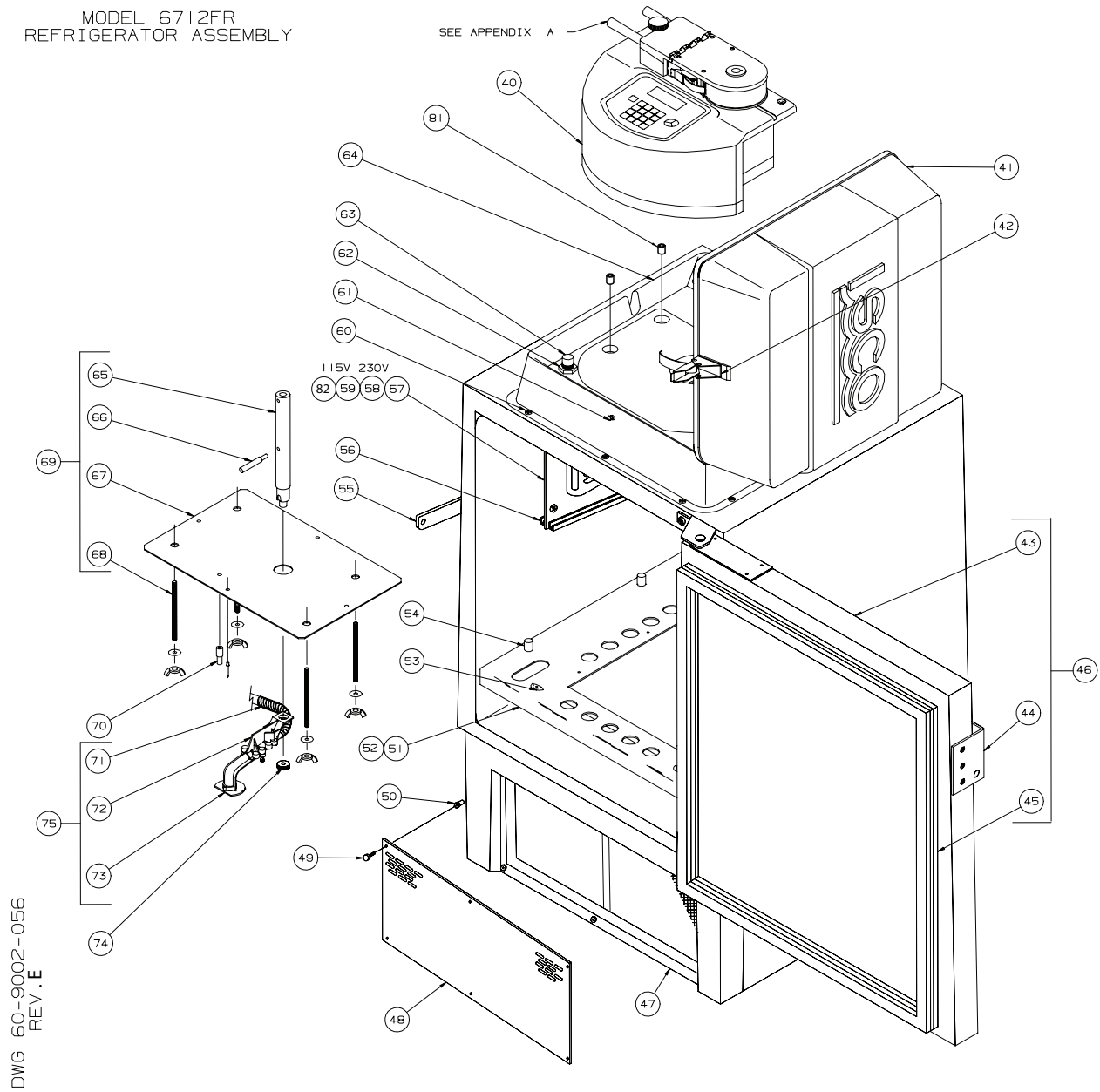

*6712FR Refrigerated Sampler  
Appendix D Replacement Parts List*

ITEM	INVENTORY NO.	DESCRIPTION
40	60-9004-330	MODEL 6712 CONTROLLER
41	60-9004-100	TOP COVER ASSY REFRIG (INCLUDES 1 & 42)
42	109-0800-00	OVER CENTER DRAW LATCH-SOUTHCO
43	60-2723-127	REFRIGERATOR DOOR OUT
44	61-2723-042	DOOR HANDLE POWDER COATED
45	60-2723-005	GASKET REFRIGERATOR DOOR
46	60-2724-062	REFRIGERATOR DOOR ASSY (INCLUDES ITEMS 43, 44 & 45)
47	60-9003-182	FILTER REFRIG
48	60-2723-032	REFRIGERATOR GRILLE
49	60-2724-021	THUMBSCREW ASSY
50	239-0908-32	WELL-NUT FASTENER #8-32 THD
51	61-9003-310	SUPPORT COMP BTL CLR ANDZD
52	61-9003-309	RACK/BTL MTG PLATE CLR ANDZD
53	60-2723-041	WIRE RACK STOP
54	60-2724-065	ADJ POST REPLACEMENT KIT
55	61-2723-043	DOOR LATCH PWDR COATED
56	60-9003-487	DRIP RAIL (LEFT)
57	60-2723-035	EVAPORATOR PLATE MOD.
<b>*+58</b>	<b>60-9004-222</b>	<b>EVAPORATOR PLATE, COP. TUBING, &amp; HTR. ASSY 230VAC.</b>
59	60-9004-259	EVAPORATOR PLATE, COP. TUBING, & HTR. ASSY 115 VAC
60	231-0186-12	SCR M SST TRH P10-24 X 3/4
61	60-2723-054	KEEPER TOP COVER LATCH
62	232-1197-02	NUT HEX JAM 5/8-18
63	60-9003-110	BULKHEAD FITTING
64	60-9003-017	CONTROLLER ADAPTOR FR
65	60-9003-273	DIST SHAFT EXTENSION FR 24 BTL
66	60-9003-301	STOP ARM
67	60-9004-121	DIST STOP PLATE ASSY
68	60-9003-300	ROD THD SST 8-32 X 5.00
69	60-9004-155	CONFIG KIT FR 12/24 BTL (INCLUDES ITEMS 65, 66, 68, & 81)
70	60-9003-209	DISTRIBUTOR STOP
71	60-9003-317	SPR CPRCN .045 WIRE
72	60-9004-019	DIST ARM ASSY TOP
73	60-9004-020	DIST ARM ASSY BOTTOM
74	60-2923-007	DISTRIBUTOR ARM NUT
75	60-9004-050	DISTRIBUTOR ARM ASSY (INCLUDES ITEMS 71, 72, & 73)
*76	60-9003-489	DRIP RAIL (RIGHT)
*77	60-2723-034	DRIP TRAY
*78	180-0012-01	KNOB PKG-100B-1/4
*79	380-9510-70	POT 10K 2W 3/4 TURN
*80	60-9004-292	(OPTIONAL) SAMPLE TEMPERATURE SENSOR
81	60-9003-614	SPACER, .25 ID SIZE 17, .25 LONG
<b>*++82</b>	<b>60-9004-022</b>	<b>EVAPORATOR PLATE, COP. TUBING, &amp; HTR. ASSY 230VAC.</b>

NOTE: \* ITEM IS NOT SHOWN IN ILLUSTRATION.  
 + ITEM IS FOR SERIAL NUMBERS PRIOR TO 216M.  
 ++ ITEM IS FOR SERIAL NUMBERS 216M OR LATER.

6712FR Refrigerated Sampler  
 Appendix D Replacement Parts List

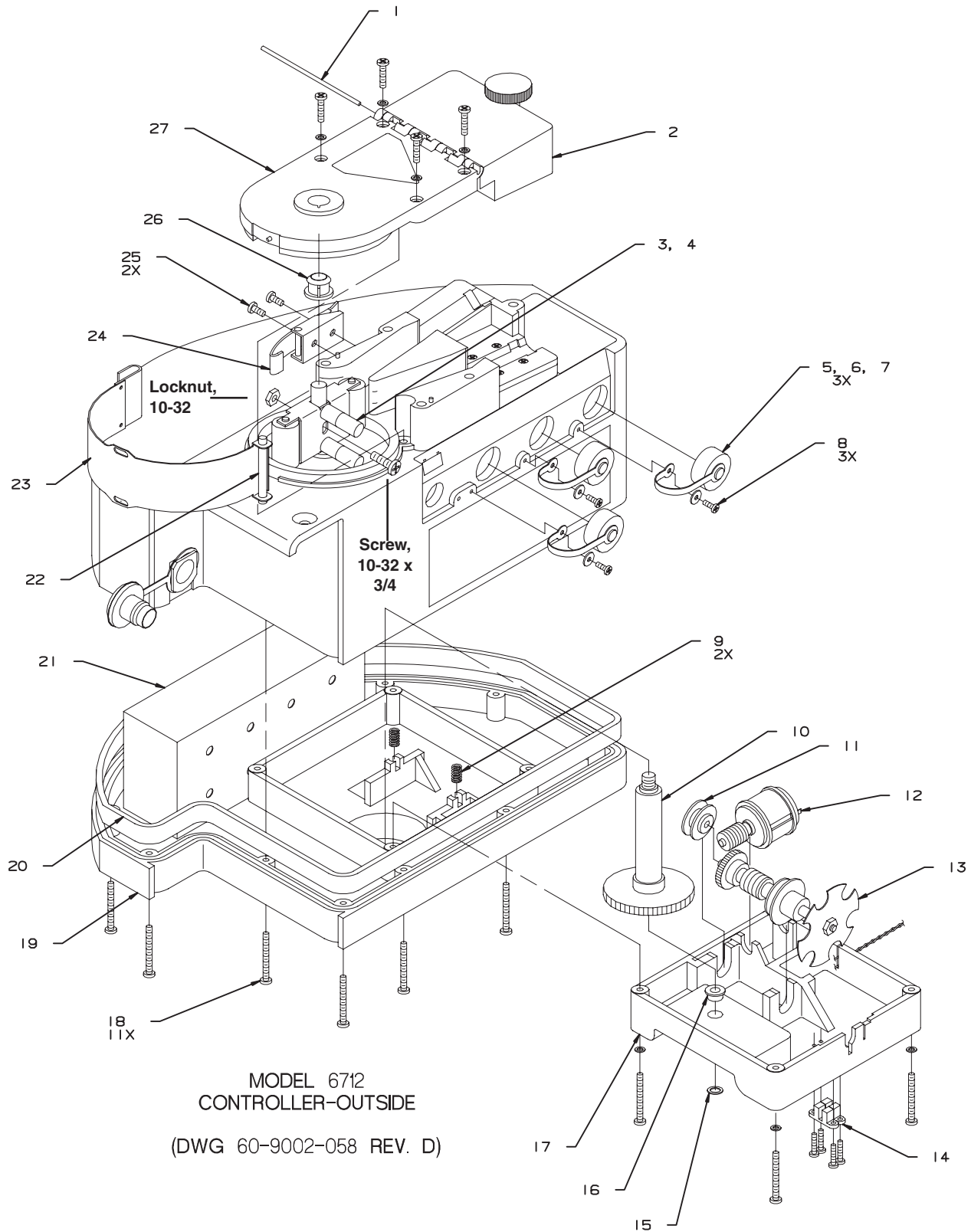



*6712FR Refrigerated Sampler*  
*Appendix D Replacement Parts List*

---

ITEM	INVENTORY NO.	DESCRIPTION
1	609003035	PIN HNG .09X3.635
2	609004013	LID ASSY LIQ DET
3	609004009	PMP PADDLE ASSY
4	232916101	NUT S 10-32
5	603113024	CAP CONN PTCTR MDM
6	603113032	GSKT CONN CAP MDM
7	609003291	STRAP CONN CAP
8	231310106	SCR SLFTPG #4X3/8
9	203012203	SPR CPRSN .042WIRE
10	609004016	SFT ASSY DISTR
11	609003040	BSHG .184 ID
12	609004014	DISTR MOT ASSY
13	609004015	SFT ASSY WORM
14	609004114	OPT SNSR ASSY
15	209000900	RTNG RING EXT.21ID
16	201312300	BRG CYL.250ID.380D
17	609003007	PL TOP DISTR (ENV)
18	231014436	SCR PNH 6-32X1 1/8
19	609004011	CONT BOX S/A BOT
20	609003054	GSKT CONT BOX
21	699003518	BOX 2.88X2.33X5.13
22	609003052	PIN HNG .18X2.000
23	609004300	PMP HSG BND ASSY
24	109080300	LCH DRAW SST
25	231311206	SCR SLFTPG #6X3/8
26	603703278	BSHG PMP (ENV)
27	609004295	PMP COV ASSY
*28	202999100	SEAL .625IDX1.000D

NOTE: \* ITEM IS NOT SHOWN IN ILLUSTRATION

**✓ Note**

Older units have a cylindrical, soldered lithium battery. Newer units have a coin-style, snap-in lithium battery. For replacement instructions, refer to *Replacing the Internal Battery*, on page 8-13.

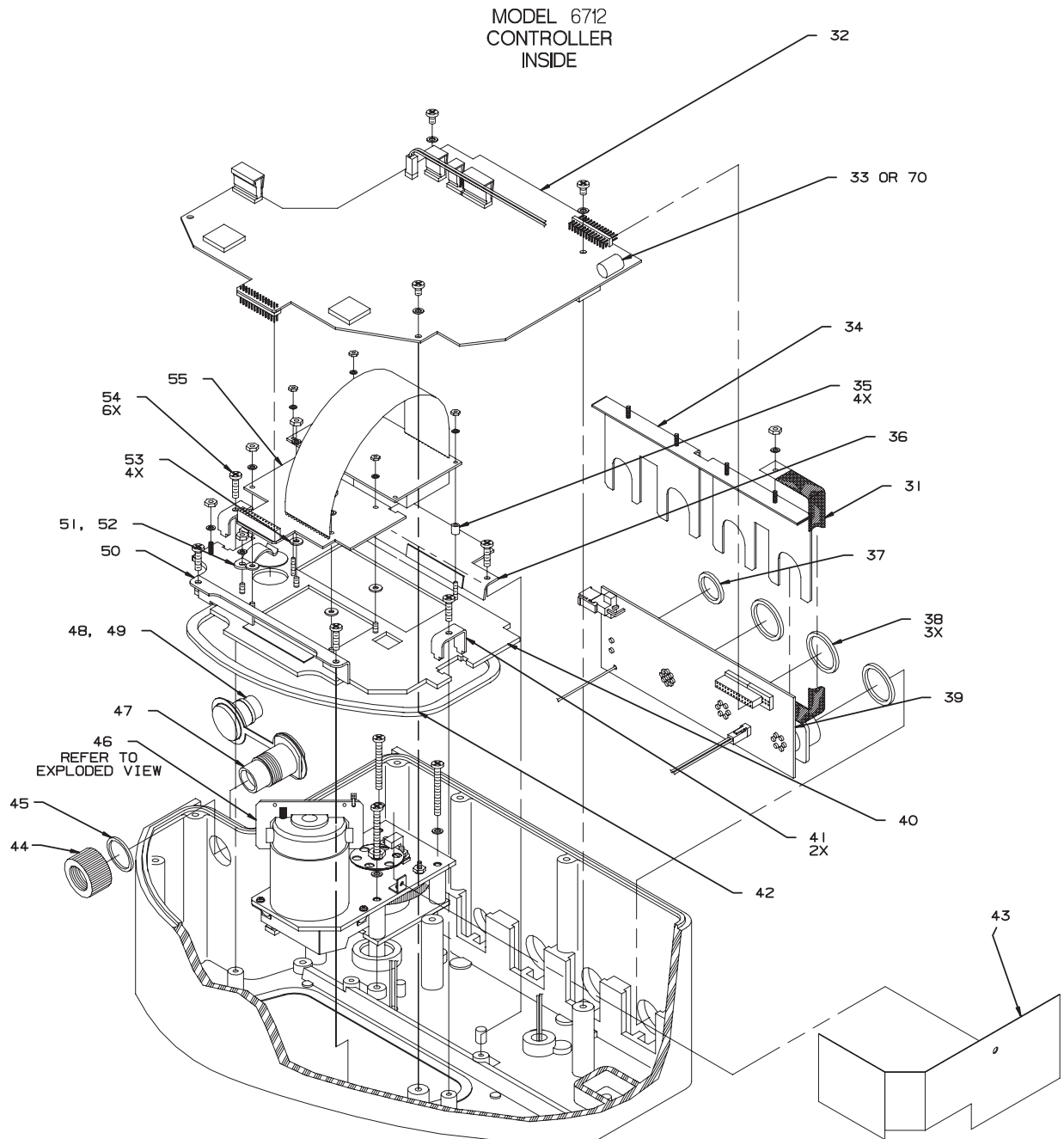

*6712FR Refrigerated Sampler*  
*Appendix D Replacement Parts List*

---

ITEM	INVENTORY NO.	DESCRIPTION
31	609003407	STRAP INTCON 3.5"
32	609004324	CBA CPU YSI CE
33	340500000	BAT 2/3A LITHIUM (CYLINDER STYLE)
34	609004201	RTNG CLIP ASSY CE
35	609003077	SPCR .188 X 0.25 L
36	609003132	HLDN CONT PNL TOP
37	202400114	O RING .612ID .103
38	202400118	O-RING .862ID .103
39	609004346	CBA 6712 CONN 2001
40	609004328	CONT PNL ASSY CE
41	609003029	HLDN CONT PNL
42	609003066	GSKT CONT PNL
43	699003554	SHLD MN PCB
44	609003020	NUT CONN
45	202100018	O-RING .739ID .070
46	609004301	PMP GR CS ASSY CE (INCLUDES ITEMS 58 THRU 69)
47	609004206	CONN ASSY 8 PIN CE
48	609003074	STRAP P
49	609003075	P FL MDL CONN
50	609003133	HLDN CONT PNL BOT
51	209902138	CLIP TNSN .375 DIA
52	490001300	HMD INDCTR CARD
53	233040405	WSHR FL .125 NYL
54	231514920	SCR SLFTP66-19X5/8
55	609004006	DSPL KYPD ASSY
57	232910100	NUT S 4-40
70	340503000	BATTERY .3AH COIN (DISK STYLE)

NOTE: \* ITEM IS NOT SHOWN IN ILLUSTRATION

6712FR Refrigerated Sampler  
 Appendix D Replacement Parts List

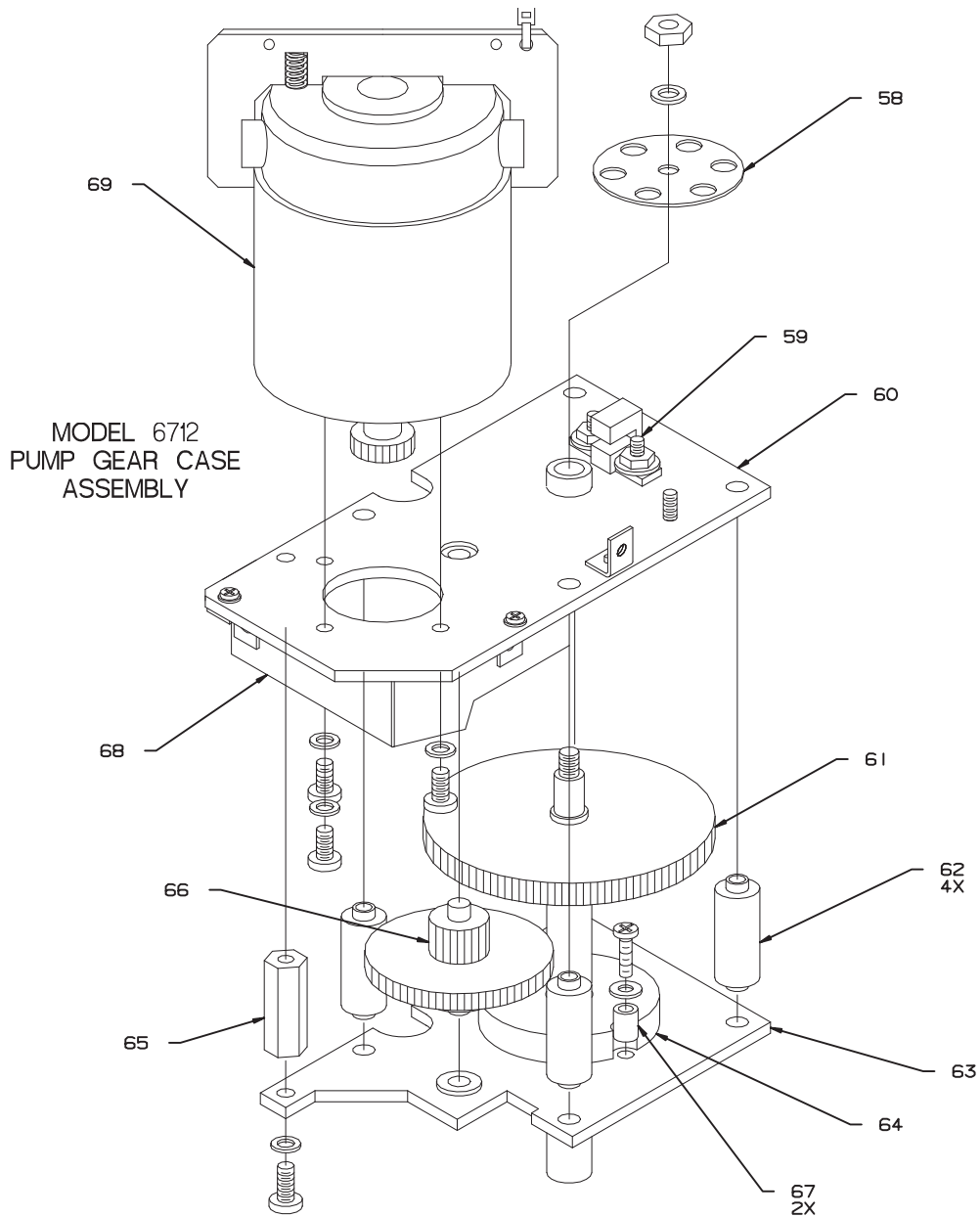

ITEM	INVENTORY NO.	DESCRIPTION
58	609003112	DISK OPT
59	609004203	WGR ASSY PMP SNSR
60	609004296	MOT MTG PL ASSY CE
61	609004304	PMP SFT ASSY
62	602703129	STDF DISTR GR CS
63	609004298	MTG PL ASSY PMP
64	609004305	SPCR 1.38 X 0.31 L
65	237263210	STDF 6-32 X 1.00 L
66	609004303	GR ASSY
67	237012000	SPACER, .140 ID X .313 OD X .312 LONG
68	699003555	SHLD DSPL
69	609004046	MOT ASSY

# 6712FR Refrigerated Sampler

## Appendix E Accessories List

### E.1 Order Information

Prices available on request. Additional items appear in *Appendix D, Replacement Parts*. Many other items are available. To order any item, contact your sales representative or the factory. Note that the part name listed on your order acknowledgment and invoice may be different than the item name listed here. When examining these documents, use the part number for reference.

Teledyne Isco  
P.O. Box 82531  
Lincoln, NE 68501  
Telephone Within U.S.A.  
Toll free: (800) 228-4373  
Outside U.S.A:(402) 464-0231  
Fax: (402) 465-3022

### E.2 Samplers

6712FR Refrigerated Sampler 115V. . . . .	68-6710-072
<i>(Includes controller, distributor arm, instruction manual and pocket guide.)</i>	
6712FR Refrigerated Sampler 230V. . . . .	68-6710-073
<i>(Includes controller, distributor arm, instruction manual and pocket guide.)</i>	
6712FR Refrigerated Sampler 115V with Temperature Logger. . . . .	68-6710-144
<i>(Includes controller, distributor arm, instruction manual and pocket guide.)</i>	
6712FR Refrigerated Sampler 230V with Temperature Logger. . . . .	68-6710-145
<i>(Includes controller, distributor arm, instruction manual and pocket guide.)</i>	
6712 Sampler Controller. . . . .	68-6710-074
<i>(Includes 2 Pump Tubes.)</i>	
6712 Samplers Pocket Guide . . . . .	60-9003-589
6712FR Refrigerated Sampler Instruction Manual . . . . .	60-9003-590

### E.3 Bottle Kits

24-Bottle Kit (350-milliliter glass bottles) . . . . .	68-6700-033
<i>(Includes bottles; bottle rack; configuration kit; and two discharge tubes).</i>	
24-Bottle Kit (1,000-milliliter polypropylene bottles) . . . . .	68-6700-032
<i>(Includes bottles; bottle rack; configuration kit; and two discharge tubes).</i>	
8-Bottle Kit (2.0-liter polyethylene bottles) . . . . .	68-6700-034
<i>(Includes bottles; bottle rack; configuration kit; and two discharge tubes).</i>	
2-Bottle Kit (7.5-liter polyethylene bottle) . . . . .	68-6700-036
<i>(Includes bottles, configuration kit and two discharge tubes).</i>	

2-Bottle Kit (9.4-liter glass bottles) . . . . .	68-6700-037
<i>(Includes bottles; configuration kit and two discharge tubes).</i>	
1-Bottle Kit (9.4-liter polyethylene bottle) . . . . .	68-6700-038
<i>(Includes bottle; configuration kit; one unlined lid; 2 lids and two discharge tubes).</i>	
1-Bottle Kit (9.4-liter glass bottle) . . . . .	68-6700-039
<i>(Includes bottle; configuration kit; 2 lids and two discharge tubes).</i>	
1-Bottle Kit (15.0-liter polyethylene bottle) . . . . .	68-6700-040
<i>(Includes bottle; configuration kit; 2 lids and two discharge tubes).</i>	
1-Bottle Kit (18.5-liter glass bottle) . . . . .	68-6700-042
<i>(Includes bottle; configuration kit; 2 lids and two discharge tubes).</i>	
1-Bottle Kit (20.5-liter polyethylene bottle) . . . . .	68-6700-041
<i>(Includes bottle; configuration kit; 2 lids and two discharge tubes).</i>	

**E.4 Bottle Racks,  
 Retaining Rings,  
 Discharge Tubes,  
 Distributor Arm**

Bottle Rack for 24-Bottle Kit (350-milliliter Glass Bottles and 8-Bottle Kits) . . . . .	60-2744-008
Bottle Rack for 24-Bottle Kit (1,000-milliliter Polypropylene Bottles). . . . .	60-2744-007
Retaining Ring for 24-Bottle Kit (350-milliliter Glass Bottles) . . . . .	60-2724-020
Retaining Ring for 24-Bottle Kit (1,000-milliliter Polypropylene Bottles). . . . .	60-3703-058
8-Bottle Adaptor for 8-Bottle Rack . . . . .	60-2743-024
Bottle Locating Base for 6700FR 2-Bottle Kits. . . . .	60-2723-102
Discharge Tube for 8-Bottle, 12-Bottle, and 24-Bottle Kits . . . . .	60-9003-279
Discharge Tube for 2-Bottle Kits . . . . .	60-9003-283
Discharge Tube for 1-Bottle Kit (9.4-liter Polyethylene Bottle and 9400-milliliter Glass Bottle). . . . .	60-9003-262
Discharge Tube for 1-Bottle Kit (15.0-liter Polyethylene Bottle) . . . . .	60-9003-264
Discharge Tube for 1-Bottle Kit (18.5-liter Glass Bottle and 20.5-liter Polyethylene Bottle). . . . .	60-9003-266
Bulk Discharge Tube (10 foot Length) . . . . .	60-6700-046
Bulk Discharge Tube (50 foot Length) . . . . .	60-6700-047
Distributor Arm (includes nut). . . . .	60-9004-050

**E.5 Bulk Sets of Bottles  
 with Lids**

Set of 24, 350-milliliter Glass Bottles with PTFE Lined Lids . . . . .	68-2100-001
Set of 100, 350-milliliter Glass Bottles with PTFE Lined Lids . . . . .	68-3700-048
Set of 24, 1,000-milliliter Polypropylene Bottles with Polyethylene Foam Lined lids). . . . .	68-2100-007
Set of 100, 1,000-milliliter Polypropylene Bottles with Polyethylene Foam Lined lids . . . . .	68-3700-046
Set of 500, 1,000-milliliter Polypropylene Bottles with Polyethylene Foam Lined lids . . . . .	68-3700-047
Set of 12, 2.5-liter Polyethylene Bottles with Lined Lids . . . . .	68-6700-059
Set of 100, 2.5-liter Polyethylene Bottles with Lined Lids . . . . .	68-6700-060
Set of 8, 1.8-liter Glass Bottles with PTFE Lined Lids . . . . .	68-2740-027
Set of 100, 1.8-liter Glass Bottles with PTFE Lined Lids . . . . .	68-3720-030
Set of 8, 2.0-liter Polyethylene Bottle with Unlined Lids . . . . .	68-2740-026
Set of 100, 2.0-liter Polyethylene Bottle with Unlined Lids . . . . .	68-3720-028
7.5-liter Polyethylene Bottle . . . . .	299-0013-07
9.4-liter (2½-gallon) Glass Bottle with Two PTFE Lined Lids. . . . .	68-2930-006
9.4-liter (2½-gallon) Polyethylene Bottle with Two Unlined Lid . . . . .	68-2740-009

15.0-liter (4-gallon) Polyethylene Bottle with Two Unlined Lids . . . . .	68-2930-004
18.5-liter (5 gallon) Glass Bottle with Two PTFE lined Lids . . . . .	68-6700-057
20.5-liter (5 <sup>1</sup> / <sub>2</sub> -gallon) Polyethylene Bottle with Two Unlined Lids . . . . .	68-2930-005

### E.6 Pump Tubes, Suction Line, Strainers

Pump Tube (Qty 5) . . . . .	60-6700-062
Pump Tube (Qty 10) . . . . .	60-6700-044
Pump Tube (Qty 25) . . . . .	60-6700-045
<sup>3</sup> / <sub>8</sub> -inch Standard Weighted Polypropylene Strainer with 10 foot Suction Line . . . . .	60-9004-378
<sup>3</sup> / <sub>8</sub> -inch Standard Weighted Polypropylene Strainer with 25 foot Suction Line . . . . .	60-9004-379
PTFE Suction Line (10 foot length) . . . . .	60-1683-146
PTFE Suction Line (25 foot length) . . . . .	60-2703-114
Bulk Vinyl Suction Line (100 foot length) . . . . .	68-1680-058
Bulk Vinyl Suction Line (500 foot length) . . . . .	68-1680-059
<sup>3</sup> / <sub>8</sub> -inch Vinyl Suction Line Accessory Kit (includes tube coupling, clamp, and instructions). . . . .	68-3700-007
<sup>3</sup> / <sub>8</sub> -inch Standard Weighted Polypropylene Strainer . . . . .	60-9004-367
CPVC Weighted Plastic-Coated Strainer . . . . .	60-3704-066
<sup>3</sup> / <sub>8</sub> -inch Stainless Steel Low Flow Strainer Only . . . . .	69-2903-138
<sup>3</sup> / <sub>8</sub> -inch Suction Line Tubing Coupler . . . . .	69-4703-106

### E.7 Data Collection Devices and Cables

581 Rapid Transfer Device (RTD). . . . .	60-9004-027
Power Cable 581 Rapid Transfer Device (RTD). . . . .	60-9004-077
Flowlink ® 5.1 for Windows Software – New License . . . . .	call factory
Flowlink ® 5.1 for Windows Software – Upgrade . . . . .	call factory
Computer Connect Cable (25-pin) . . . . .	60-2544-040
Computer Connect Cable (9-pin) . . . . .	60-2544-044
Connector to Attach Non-Isco Flow Meter to Customer Supplied Cable . . . . .	68-1680-060
Serial Output Connect Cable (for use with the periodic serial output feature). . . . .	60-9004-263
External 12-volt DC Power Cable . . . . .	60-1394-023
Flow Meter-to-Two Samplers Cable . . . . .	60-3004-018
Dual Sampler Mode Interconnect Cable . . . . .	60-3704-065
Dual Sampler Mode-to-Flow Meter Cable . . . . .	60-3704-080
Non-Isco Flow Meter-to-Sampler Cable . . . . .	60-1394-077
Sampler to Flow Meter /1640 Liquid Level Actuator “Y” Cable . . . . .	60-3004-019
Sampler to Flow Meter Cable . . . . .	60-3004-107
2100 Series Sampler Interface Cable . . . . .	60-2004-260
Solar Panel “Y” Cable . . . . .	60-3004-098
Solar Panel/Interrogator. Extension Cable . . . . .	60-2544-028
Solar Panel Cable (25 foot length) . . . . .	60-3004-097
Rain Gauge/Refrigerator Temperature Sensor “Y” cable . . . . .	60-9004-294
4200T Modem . . . . .	factory installed

Contact your sales representative or Teledyne Isco Customer Service.

 **Note**

The modem is disabled when an interrogator cable is connected to the sampler's interrogator port. It cannot receive incoming calls, and the alarm dialout will be rendered inoperative, while this cable is connected. **Disconnect the interrogator cable in order to use the 4200T modem.**

CDMA Digital Cellular Modem with Serial-Over-IP capability . . . . . 68-6710-148  
GSM Digital Cellular Modem . . . . . 60-5314-563  
*(Requires sampler software 2.34 and the purchase of a SIM card from your preferred provider.)*

### E.8 12-Volt Power Sources

913 High Capacity Power Pack (115-volt) . . . . . 60-1684-088  
914 Battery-Backed Power Pack (115-volt) . . . . . 60-3004-130  
921 Nickel-Cadmium Battery . . . . . 60-1684-040  
923 High Capacity Power Pack (240-volt) . . . . . 60-1684-093  
924 Battery-Backed Power Pack (240-volt) . . . . . 60-3004-160  
947 Lead-Acid Battery . . . . . 60-3004-106  
Manual Body - Power Products Guide . . . . . 60-9003-092

### E.9 Modules, Rain Gauges, & Interfacing Instruments

*(Note: Additional accessories for modules and interfacing instruments appear in the accessories list at the back of the manual for each module or instrument.)*

701 pH Module with Double Junction pH Sensor with Temperature Sensor . . . . . 68-6700-052  
720 Submerged Probe Module, 10 ft range . . . . . 68-6700-068  
730 Bubbler Flow Module . . . . . 68-6700-050  
780 Analog Interface Module . . . . . 60-9004-040  
675 Rain Gauge . . . . . 60-3284-013  
1640 Liquid Level Actuator . . . . . 60-1644-000  
4-20 mA Sampler Input Interface . . . . . 60-3704-075  
Refrigerator Temperature Sensor with 5 ft (1.55 m) cable . . . . . 68-6700-136  
Internal 3-channel 4-20 mA programmable output  
for 6700 Series sampler. Includes multi-analog output cable, 10 ft. . . . . 60-9004-266

### E.10 SDI-12 Data Acquisition Connect Cables

*Note: Y-connect cables can be combined with other Y-connect cables or SDI-12 adapter cables if multiple SDI-12 devices are to be connected.*

Rain Gauge Y-Connect Cable . . . . . 60-9004-294  
*(This cable allows connection of 2 of the following: rain gauge, SDI-12 adapter cable, SDI-12 Y-connect cable, I/O adapter, temperature sensor.)*  
YSI SDI-12 Adapter Cable . . . . . 60-9004-337  
YSI SDI-12 Y-Connect Cable . . . . . 60-9004-338  
*(This cable allows connection of a YSI SDI-12 sonde and an Isco Rain Gauge.)*  
Hydrolab Quanta SDI-12 Adapter Cable . . . . . 60-9004-339  
Hydrolab Quanta SDI-12 Y-Connect Cable . . . . . 60-9004-340



*(This cable allows connection of a Hydrolab Quanta SDI-12 sonde and an Isco Rain Gauge.)*

SDI-12 Adapter Cable (6 foot length, no connector) .....60-9004-341

*(This is for use with a customer supplied connector to an SDI-12 device.)*

SDI-12 Y-Connect Cable (6 foot length, no connector).....60-9004-342

*(This is for use with a customer supplied connector to an SDI-12 device and an Isco Rain Gauge.)*



# 6712FR Refrigerated Sampler

---

## Index

### A

---

#### Accessories

- bottle racks E-2
  - bulk bottles E-2
  - bulk discharge tubing E-3
  - cables E-3
  - data collection accessories E-3
  - power sources and battery chargers E-4
  - pump tube E-3
  - refrigerator temperature sensor E-4
  - retaining rings E-2
  - strainers E-3
  - suction line E-3
- acknowledge dialout alarm 5-40  
alarm acknowledgement 5-40  
alarms 5-39
- Alkaline battery
- battery warning 8-13
  - opening controller case 8-11
  - replacing 8-13
- Analog output 5-41  
analog output 5-41

### B

---

- Backlighting 5-30
- Bottle kits
- installing 2-4
- Bottle Number Signal 5-31
- Bottles-per-sample distribution 4-6, 5-16

### C

---

- Cables
- Master/Slave-to-Flow-Meter Cable 5-29
- Calendar 3-5
- setting clock and calendar 3-6, 8-3
- Calibration
- during a manual pause 4-13
  - sample volumes 4-14
- Cleaning protocols 8-3
- Clock
- setting clock and calendar 3-6, 8-3
- Clock start-time menu 3-6
- Combined results report
- see Sampling reports
- Compatible Isco products 1-6
- Computer control 7-1
- checksum validation 7-8
  - external program control 7-4
  - menu control 7-2
  - remote keypad 7-8
  - sampling reports 7-3
- Configuring reports 4-19
- Construction
- compact and standard sampler 1-9
- Continuous sampling 2-13, 4-6, 5-17
- Controller

- mounting on refrigerator 2-1
- Count Switched Distribution
- Sampler Enable 5-22

### D

---

- Data collection accessories
- accessories list E-3
- Desiccant
- opening controller case 8-11
- Diagnostic tests
- distributor test 8-7
- Diagnostics 8-6
- Dialout alarms 4-18, 5-39
- dialout alarms 5-39
- Display Backlighting 5-30
- Distribution 4-6, 5-16
- bottles-per-sample distribution 4-6, 5-16
  - continuous sampling 4-6, 5-17
  - count-switched distribution 5-16
  - event pacing 5-12
  - multiple-bottle compositing 5-16
  - random-interval pacing 5-15
  - Samples per bottle 4-6, 5-16
  - sequential distribution 4-6, 5-16
  - time-switched distribution 5-16
- Dual sampler mode 5-29

### E

---

- Enable
- see Sampler enable
- Error messages 8-15
- Event marks 5-30
- 3-second pulse 5-31
  - master/slave sampling 5-29
  - timing diagram 5-31
  - variable-duration pulse 5-31
- Event pacing 5-12
- Extended programming
- extended programming features 1-8-??
  - one-part and two-part programs 5-1
  - showing extended screens 3-3, 4-1, 5-1

### F

---

- First valid day 4-8
- Flow pacing 4-5
- Flow proportional sample volumes 5-19

### G

---

- Grab samples 4-13, 4-14

### H

---

- hardware
- analog output 5-41
  - cellular modems 5-40
  - dialout alarms 5-39

- I/O pin programming 5-37
- pager numbers 5-40
- rain gauge 5-36
- refrigerator temperature 5-41
- sonde 5-36
- Hardware set-up
  - master/slave sampling 5-29
- hardware setup 5-36

## I

---

- I/O pin programming 5-37
- Installing
  - locating base for 2-bottle kit 2-6
  - suction line 2-10, 2-11
- Interrupting
  - interrupting a running program 4-12
  - manual paused operation 4-12

## L

---

- Line rinses 5-12
- Liquid detector enable/disable 5-28
- Locating base
  - 2-bottle kit 2-6

## M

---

- Maintenance
  - alkaline battery 8-13
  - checklist 8-7
  - cleaning
    - guidelines 8-1
    - protocols for bottles and tubing 8-3
  - maintenance programming screens 8-3
    - diagnostics 8-6
    - pump counts for pump tube warning 8-7
    - pump tube alarm 8-7
    - reinitializing 8-7
  - opening controller case 8-11
  - pump tube 8-7
  - servicing the refrigerator
    - electrical system 8-16
    - refrigeration system 8-19
- Manual functions 4-14
  - calibrate volume 4-14
  - grab samples 4-14
  - moving distributor 4-17
  - running pump manually 4-17
- Manual paused operation 4-12-??
- Master/slave sampling 5-29
  - event marks 5-29
  - sampler enable 5-29
- Master/Slave-to-Flow-Meter Cable 5-29
- Materials
  - used in sampler construction 1-9
- Memory 1-6, 5-42
  - capacity 1-5, 5-43
  - creating partitions 5-42
  - data-storage interval 5-42
  - partition sizes 5-42
  - roll-over 5-43
  - sampling results 5-42
  - stored data will be lost! 5-1
  - triggered 5-43
- Menu screens 3-3
- Modem 7-9
- modems 1-2
  - CDMA serial-over-IP 1-3
  - CSD 1-3

- GSM 1-2
- landline 1-2
- software compatibility 1-3
- Module summary report
  - see Sampling reports
- Modules
  - 700 Series Modules 1-2
  - displayed readings 4-11
- Multiple-bottle compositing 5-16

## N

---

- Nonuniform time pacing 5-15

## O

---

- One-part programs 5-1
- Operating
  - running sampling programs 4-10, 5-27
- Other Functions
  - see Hardware setup 4-14, 5-28
  - see Maintenance 4-14, 5-28
  - see Manual functions 4-14, 5-28
  - see Programming Style 4-14, 5-28

## P

---

- Pacing 4-5, 5-12
  - event pacing 5-12
  - flow pacing 4-5
  - nonuniform clock-time pacing 5-15
  - nonuniform time pacing 5-15
  - random-interval pacing 5-15
  - time pacing 4-5, 5-12
- Partitions
  - creating 5-42
- Pause and resume 5-27
- Periodic serial output 5-39
- Power sources
  - accessories list E-4
- Presample purge
  - event marks 5-31
- Program name menu
  - how to use 3-7
- Program settings report
  - see Sampling reports
- Program storage
  - see Stored programs
- Program Style 3-4
- Programming
  - changing program name 3-8
  - changing site description 3-8
  - clock and calendar 3-5
  - extended programming features 1-8-??
  - menu screens 3-3
  - program name menu 3-7
  - running programs 4-10, 5-27
  - site description menu 3-7
  - text entry 3-7
- Pump
  - running pump manually 4-17
- pump
  - wetted parts 8-2
- Pump Counts
  - pump tube warning 8-7
- Pump counts
  - purging a nonstandard suction line 5-31
- Pump tube
  - accessories list E-3
  - replacing 8-7
  - warning 8-4

---

## Q

Quick View Screens 3-4  
see Program Style

---

## R

rain gauge setup 5-36  
Random-interval pacing 5-15  
refrigerator temperature 5-41  
Refrigerator temperature sensor 5-41, E-4  
Reinitialize controller  
    effects on stored programs 8-7  
Remote access  
    computer commands 7-1  
    telephone commands 7-9  
Replacing internal alkaline battery 8-13  
Resume 5-27  
Retries 5-12  
Rinses 5-12  
RS-232 communications 7-1  
Running programs 4-10, 5-27

---

## S

Sample volume  
    calibrating 4-14  
    flow proportional 5-19  
    measuring 2-10  
    variable volume sampling 5-19  
Sampler enable 4-9, 5-22  
    "dry period" option 5-26  
    master/slave sampling 5-29  
    repeatable enable 5-25  
    sample at enable or disable 5-25  
    start delay 5-26  
    start times 4-8  
    stay enabled 5-25  
Samples per bottle 4-6, 5-16  
Sampling cycle 2-9  
Sampling programs  
    running programs 4-10, 5-27  
Sampling reports  
    Collecting reports 4-18, 5-28  
    configuring 4-19  
    sampling results report 4-20  
    Viewing 4-18  
Sampling results report  
    see Sampling reports  
Sampling retries 5-12  
SDI-12 parameters 6-2  
Sequential distribution 4-6, 5-16  
Serial output 5-39, 7-6  
Servicing 2-13  
    service schedule 2-13  
Site description menu  
    how to use 3-7  
software compatibility 1-3  
sonde setup 5-36  
sondes 6-1  
    AQ700 6-1  
    calibration 6-7  
    data storage 6-6  
    disconnect 6-8  
    Isco ready 6-4  
    non-Isco ready 6-5  
    parameters 6-2  
    scan 6-3  
Start times  
    clock start-time menu 3-6

    event pacing 5-12  
    first valid day 4-8, 5-27  
    sampler enable 4-8  
Stored data 5-1  
Stored programs 5-2  
    effects of reinitializing controller to factory  
        settings 8-7  
    selecting a program 5-2  
Stormwater monitoring  
    Two-part programs 5-2  
Strainers  
    accessories list E-3  
    selecting 2-8  
Suction head  
    auto suction head 5-12  
    automatic determination 5-12  
    manual (ENTER HEAD) settings 5-12  
    variations in pump counts for fluctuating heads  
        4-20  
Suction line  
    accessories list E-3  
    attaching to pump tube 2-7  
    installing and routing 2-10  
    measuring and cutting 2-7  
System IDs 4-18

---

## T

Technical specifications  
    refrigerator ??-1-16  
Telephone commands 7-9  
telephone communication 1-2  
Text entry  
    numbers 3-3  
    program names 3-7  
    site descriptions 3-7  
text messaging 5-40  
Time pacing 4-5, 5-12  
Times and dates  
    entering times and dates 3-5  
Time-switched distribution 5-16  
    pause and resume 5-27  
Tube coupling  
    attaching suction line 2-7  
Two-part programs 5-1  
    storm-water monitoring 5-2

---

## V

Variable volume sampling 5-19  
Variable-duration pulse 5-31  
    event marks 5-31  
Voice modem 7-9

---

## W

Warning  
    warning messages 8-15  
wetted parts 8-2

---

## Y

YSI 600  
    about the sonde 1-2  
    displayed readings 4-11



产品中有毒有害物质或元素的名称及含量

Name and amount of Hazardous Substances or Elements in the product

部件名称 Component Name	有毒有害物质或元素 Hazardous Substances or Elements					
	铅 (Pb)	汞 (Hg)	镉 (Cd)	六价铬 (Cr(VI))	多溴联苯 (PBB)	多溴二联苯 (PBDE)
线路板 Circuit Boards	X	O	O	O	O	O
显示 Display	X	O	O	O	O	O
接线 Wiring	O	O	O	O	X	O
内部电缆 Internal Cables	O	O	O	O	X	O
压缩机 Compressor	O	O	O	O	X	O
绝缘, 绝热 Insulation	O	O	O	O	X	O
主电源线 Line Cord	O	O	O	O	X	O
电源 Power Supply	X	O	O	O	X	O
直流电机 DC Motor	X	O	O	O	X	O
小键盘 Keypad	O	O	O	O	X	O
接头 Connectors	O	O	X	O	O	O

产品中有毒有害物质或元素的名称及含量：Name and amount of Hazardous Substances or Elements in the product

O: 表示该有毒有害物质在该部件所有均质材料中的含量均在ST/ 标准规定的限量要求以下。

O: Represent the concentration of the hazardous substance in this component's any homogeneous pieces is lower than the ST/ standard limitation.

X: 表示该有毒有害物质至少在该部件的某一均质材料中的含量超出ST/ 标准规定的限量要求。

(企业可在此处，根据实际情况对上表中打“X”的技术原因进行进一步说明。)

X: Represent the concentration of the hazardous substance in this component's at least one homogeneous piece is higher than the ST/ standard limitation.

(Manufacturer may give technical reasons to the "X"marks)

环保使用期由经验确定。

The Environmentally Friendly Use Period (EFUP) was determined through experience.

生产日期被编码在系列号码中。前三位数字为生产年(207 代表 2007 年)。随后的一个字母代表月份：

A 为一月，B 为二月，等等。

The date of Manufacture is in code within the serial number. The first three numbers are the year of manufacture (207 is year 2007) followed by a letter for the month. "A" is January, "B" is February and so on.





# DECLARATION OF CONFORMITY

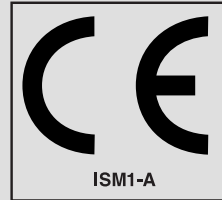

Application of Council Directive: 89/336/EEC – The EMC Directive  
73/23/EEC – The Low Voltage Directive  
Manufacturer's Name: Teledyne Isco, Inc.  
Manufacturer's Address: 4700 Superior, Lincoln, Nebraska 68504 USA  
Mailing Address: P.O. Box 82531, Lincoln, NE 68501  
Equipment Type/Environment: Laboratory Equipment for Light Industrial/Commercial Environments  
Trade Name/Model No: 4200T Modem  
Year of Issue: 2001  
Standards to which Conformity is Declared: EN 55024-1998 EMC Requirements for Information Technology Equipment  
EN 60950 Safety Requirements for Information Technology Equipment  
FCC Part 68

Standard	Description	Severity Applied	Performance Criteria
EN61000-4-2	Electrostatic Discharge	Level 2 - 4kV contact discharge Level 3 - 8kV air discharge	B B
EN61000-4-3	Radiated RF Immunity	80 MHz to 1000MHz 80% AM at 1kHz Level 1 - 10V/m	A
EN61000-4-4	Electrical Fast Transient	Level 2 - 2kV on ac lines	B
EN61000-4-5	Surge on AC Lines	1kV common mode, 1kV differential mode	B
EN61000-4-6	Conducted RF on AC lines	150 kHz to 80 MHz, 3V rms, 80% modulated	B
EN61000-4-11	Voltage Dips/Short Interruptions	0.5 cycle, each polarity/100%	B
EN 55022	RF Emissions	Group 1, Class A, Information Technology Equipment	
EN61000-3-2, 3-3	Harmonic, Flicker		

We, the undersigned, hereby declare that the design of the equipment specified above conforms to the above Directive(s) and Standards as of July 5, 2001.

William Foster  
USA Representative



William Foster  
Director of Engineering  
Teledyne Isco, Inc.  
4700 Superior Street  
Lincoln, Nebraska 68504

Phone: (402) 464-0231  
Fax: (402) 464-4543

60-3212-049  
Rev. A



# DECLARATION OF CONFORMITY

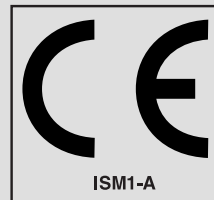

Application of Council Directive: 89/336/EEC – The EMC Directive  
73/23/EEC – The Low Voltage Directive

Manufacturer's Name: Teledyne Isco, Inc.

Manufacturer's Address: 4700 Superior, Lincoln, Nebraska 68504 USA  
Mailing Address: P.O. Box 82531, Lincoln, NE 68501

Equipment Type/Environment: Laboratory Equipment for Light Industrial/Commercial Environments

Trade Name/Model No: 6712FR Refrigerated Sampler

Year of Issue: 2001

Standards to which Conformity is Declared: EN 61010-1 Safety Requirements for Electrical Equipment for Measurement, Control, and Laboratory Use  
EN 61326:1998 EMC Requirements for Electrical Equipment for Measurement, Control, and Laboratory Use  
EN60529 Degrees of Protection Provided by the Enclosure IP-26

Standard	Description	Severity Applied	Performance Criteria
EN61000-4-2	Electrostatic Discharge	Level 2 - 4kV contact discharge Level 3 - 8kV air discharge	A
EN61000-4-3	Radiated RF Immunity	80 MHz to 1000MHz 80% AM at 1kHz Level 1 - 10V/m	A
EN61000-4-4	Electrical Fast Transient	Level 2 – 2kV on AC lines	A
EN61000-4-5	Surge on I/O Lines	2kV common mode, 1KV differential mode	A
EN61000-4-6	Conducted RF on AC lines	150 kHz to 80 MHz, 3V rms, 80% modulated	A
EN61000-4-11	Voltage Dips/Short Interruptions	0.5 cycle, each polarity/100%	A
CISPR11/ EN 55011	RF Emissions	Group 1, Class A Industrial, Scientific, and Medical Equipment	
EN61000-3-2, 3-3	Harmonic, Flicker		

We, the undersigned, hereby declare that the design of the equipment specified above conforms to the above Directive(s) and Standards as of March 6, 2001

William Foster  
USA Representative



William Foster  
Director of Engineering  
Teledyne Isco, Inc.  
4700 Superior Street  
Lincoln, Nebraska 68504

Phone: (402) 464-0231  
Fax: (402) 464-4543

60-9002-072  
Rev B



## Teledyne Isco One Year Limited Factory Service Warranty\*

This warranty exclusively covers Teledyne Isco instruments, providing a one-year limited warranty covering parts and labor.

Any instrument that fails during the warranty period due to faulty parts or workmanship will be repaired at the factory at no charge to the customer. Teledyne Isco's exclusive liability is limited to repair or replacement of defective instruments. Teledyne Isco is not liable for consequential damages.

Teledyne Isco will pay surface transportation charges both ways within the 48 contiguous United States if the instrument proves to be defective within 30 days of shipment. Throughout the remainder of the warranty period, the customer will pay to return the instrument to Teledyne Isco and Teledyne Isco will pay surface transportation to return the repaired instrument to the customer. Teledyne Isco will not pay air freight or customer's packing and crating charges. This warranty does not cover loss, damage, or defects resulting from transportation between the customer's facility and the repair facility.

The warranty for any instrument is the one in effect on date of shipment. The warranty period begins on the shipping date, unless Teledyne Isco agrees in writing to a different date.

Excluded from this warranty are normal wear; expendable items such as desiccant, pH sensors, charts, ribbon, lamps, tubing, and glassware; fittings and wetted parts of valves; check valves, pistons, piston seals, wash seals, cylinders, pulse damper diaphragms, inlet lines and filter elements; and damage due to corrosion, misuse, accident, or lack of proper **installation or** maintenance. This warranty does not cover products not sold under the Teledyne Isco trademark or for which any other warranty is specifically stated.

No item may be returned for warranty service without a return authorization number (RMA) issued by Teledyne Isco.

**This warranty is expressly in lieu of all other warranties and obligations and Teledyne Isco specifically disclaims any warranty of merchantability or fitness for a particular purpose.**

The warrantor is Teledyne Isco, 4700 Superior, Lincoln, NE 68504, U.S.A.

**\*This warranty applies to the USA and countries where Teledyne Isco does not have an authorized dealer. Customers in countries outside the USA, where Teledyne Isco has an authorized dealer, should contact their Teledyne Isco dealer for warranty service.**

Problems can often be diagnosed and corrected without returning the instrument to the factory. Before returning any instrument for repair, please contact the Teledyne Isco Service Department for instructions and to obtain a return material authorization number (RMA).

Instruments needing factory repair should be packed carefully and shipped to the attention of the service department. Small, non-fragile items can be sent by insured parcel post. **PLEASE WRITE THE RMA NUMBER ON THE OUTSIDE OF THE SHIPPING CONTAINER** and enclose a note explaining the problem.

**Shipping Address:** Teledyne Isco - Attention Repair Service  
4700 Superior Street  
Lincoln, NE 68504 USA

**Mailing Address:** Teledyne Isco  
PO Box 82531  
Lincoln, NE 68501 USA

**Phone:** Repair service: (800) 775-2965 (lab instruments)  
(866) 298-6174 (samplers & flow meters)  
Sales & General Information: (800) 228-4373 (USA & Canada)

**Fax:** (402) 465-3001

**Email:** IscoService@teledyne.com



March 2, 2016 P/N 60-1002-040 Rev J

 **TELEDYNE ISCO**  
Everywhereyoulook™

