

# Capacitance Transmitters

SITRANS LC300

Operating Instructions · 04/2010

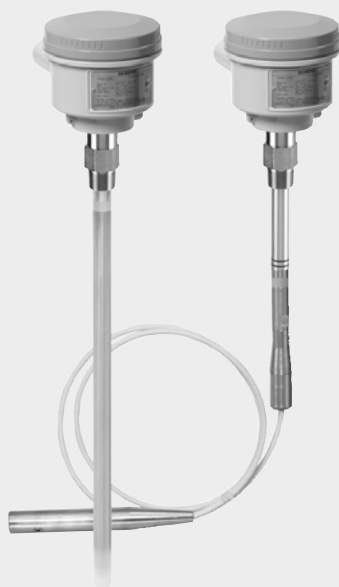

SITRANS

**SIEMENS**

**Safety Guidelines:** Warning notices must be observed to ensure personal safety as well as that of others, and to protect the product and the connected equipment. These warning notices are accompanied by a clarification of the level of caution to be observed.

**Qualified Personnel:** This device/system may only be set up and operated in conjunction with this manual. Qualified personnel are only authorized to install and operate this equipment in accordance with established safety practices and standards.

**Unit Repair and Excluded Liability:**

- The user is responsible for all changes and repairs made to the device by the user or the user's agent.
- All new components are to be provided by Siemens Milltronics Process Instruments Inc.
- Restrict repair to faulty components only.
- Do not reuse faulty components.

**Warning:** Cardboard shipping package provides limited humidity and moisture protection. This product can only function properly and safely if it is correctly transported, stored, installed, set up, operated, and maintained.

**This product is intended for use in industrial areas. Operation of this equipment in a residential area may cause interference to several frequency based communications.**

**Note:** Always use product in accordance with specifications.

**Copyright Siemens Milltronics Process Instruments Inc. 2010. All Rights Reserved**

This document is available in bound version and in electronic version. We encourage users to purchase authorized bound manuals, or to view electronic versions as designed and authored by Siemens Milltronics Process Instruments Inc. Siemens Milltronics Process Instruments Inc. will not be responsible for the contents of partial or whole reproductions of either bound or electronic versions.

**Disclaimer of Liability**

While we have verified the contents of this manual for agreement with the instrumentation described, variations remain possible. Thus we cannot guarantee full agreement. The contents of this manual are regularly reviewed and corrections are included in subsequent editions. Please check the website shown below for the latest manual revisions. We welcome all suggestions for improvement.

Technical data subject to change.

MILLTRONICS® is a registered trademark of Siemens Milltronics Process Instruments Inc.

**Contact SMPI Technical Publications at the following address:**

Technical Publications  
Siemens Milltronics Process Instruments Inc.  
1954 Technology Drive, P.O. Box 4225  
Peterborough, Ontario, Canada, K9J 7B1  
Email: [techpubs.smpi@siemens.com](mailto:techpubs.smpi@siemens.com)

**European Authorized Representative**

Siemens AG  
Industry Sector  
76181 Karlsruhe  
Deutschland

- For a selection of Siemens Milltronics level measurement manuals, go to: **[www.siemens.com/level](http://www.siemens.com/level)**. Choose **Support**, and then **Manuals / Operating Instructions**.
- For a selection of Siemens Milltronics weighing manuals, go to: **[www.siemens.com/weighing](http://www.siemens.com/weighing)**. Choose **Support**, and then **Manuals / Operating Instructions**.

# Table of Contents

---

Safety notes	
The manual .....	1
Technical support .....	2
<b>SITRANS LC300 .....</b>	<b>4</b>
Applications .....	5
Features .....	5
<b>Technical Specifications .....</b>	<b>6</b>
<b>Dimensions .....</b>	<b>10</b>
Threaded rod version with PFA probe .....	11
Threaded rod version with PFA probe and stilling well .....	12
Cable version, non-insulated, threaded .....	13
Cable version, insulated, threaded .....	14
Welded flange .....	15
Welded flange, threaded, with stilling well .....	16
Cable version, non-insulated, welded flange .....	17
Cable version, insulated, welded flange .....	18
Cable tensile strength .....	19
Shortening the cable .....	19
<b>Installation .....</b>	<b>20</b>
Location .....	20
Pressure Equipment Directive, PED, 97/23/EC .....	20
<b>Mounting .....</b>	<b>21</b>
Multiple units and wall restriction .....	21
Process cautions .....	22
<b>Wiring .....</b>	<b>23</b>
Signal amplifier/power supply .....	23
Connecting the SITRANS LC300 .....	24
Product nameplates .....	24
Wiring setups for hazardous area installations .....	24
Instructions specific to hazardous area installations .....	26
<b>Operation .....</b>	<b>27</b>
Start up .....	27
Menu position 0 .....	28
Menu position 1 .....	28
Menu position 2 .....	28
Menu position 3 .....	29
Menu position 4 .....	30
Menu position 5 .....	31
Recommissioning .....	31
Maintenance .....	32
Unit repair and excluded liability .....	32

**Appendix A: Technical References .....33**

## Safety notes

Special attention must be paid to warnings and notes highlighted from the rest of the text by grey boxes.



**WARNING:** relates to a caution symbol on the product, and means that failure to observe the necessary precautions can result in death, serious injury, and/or considerable material damage.







**WARNING<sup>1</sup>:** means that failure to observe the necessary precautions can result in death, serious injury, and/or considerable material damage.

**CAUTION:** means that failure to observe the necessary precautions can result in considerable material damage.

**Note:** means important information about the product or that part of the operating manual.

## Safety marking symbols

In manual	On Product	Description
		Caution: refer to accompanying documents (manual) for details.
		Earth (ground) Terminal
		Protective Earth Terminal

## The manual

**Note:** Please follow the installation and operating procedures for a quick, trouble-free installation and to ensure the maximum accuracy and reliability of your SITRANS LC300. This manual applies to the SITRANS LC300 model only.

This manual will help you set up your SITRANS LC300 for optimum performance.

Sections in this manual are designated as follows:

- *SITRANS LC300 - an introduction to SITRANS LC300 and to the manual*
- *Technical Specifications*
- *Installation*
- *Wiring*
- *Operation*
- *Appendix A: Technical References*

<sup>1</sup> This symbol is used when there is no corresponding caution symbol on the product.

We always welcome suggestions and comments about manual content, design, and accessibility. Please direct your comments to [techpubs.smpi@siemens.com](mailto:techpubs.smpi@siemens.com).

For other Siemens Milltronics level measurement manuals, go to: [www.siemens.com/level](http://www.siemens.com/level) and look under **Level Measurement**.

## Application examples

The application examples used in this manual illustrate typical installations using SITRANS LC300; other configurations may also apply.

In all examples, substitute your own application details. If the examples do not apply to your application, check the applicable parameter reference for the available options.

## Technical support

Support is available 24 hours a day.

To find your local Siemens Automation Office address, phone number and fax number go to:

[www.siemens.com/automation/partner](http://www.siemens.com/automation/partner)

- Click on the tab **Contacts by Product** then find your product group (**+Process Automation > +Process Instrumentation > Level Measuring Instruments**).
- Select the team **Technical Support**. Click on **Next**.
- Click on the appropriate continent, then select the country followed by the city. Click on **Next**.

For on-line technical support go to:

[www.siemens.com/automation/support-request](http://www.siemens.com/automation/support-request)

- Enter the device name or order number, then click on **Search**, and select the appropriate product type. Click on **Next**.
- You will be prompted to enter a keyword describing your issue. Then either browse the relevant documentation, or click on **Next** to email a detailed description of your issue to Siemens Technical Support staff.

**Siemens A&D Technical Support Center:** phone +49 180 50 50 222

fax +49 180 50 50 223

# Abbreviations and identifications

Short form	Long Form	Description	Units
CE / FM / CSA	Conformité Européene / Factory Mutual / Canadian Standards Association	safety approval	
DCS	Distributed Control System	control room apparatus	
Ex	Explosion Proof		
Exd	Flame Proof		
ESD	Electrostatic Discharge		
LRV	Lower Range Value	value for 0 % (in pF)	4 mA
PED	Pressure Equipment Directive	safety approval	
pF	pico Farads	$10^{-12}$	Farad
PV	Primary Variable	measured value	
Stilling Well	Grounded metal tube with openings		
URV	Upper Range Value	value for 100% (in pF)	20 mA

# SITRANS LC300

**Notes:**

- SITRANS LC300 is to be used only in the manner outlined in this instruction manual, otherwise protection provided by the equipment may be impaired.
- This product is intended for use in industrial areas. Operation of this equipment in a residential area may cause interference to several frequency based communications.

SITRANS LC300 is a cost-effective instrument for level measurement in applications such as the processing of food and beverages, pharmaceuticals, detergents and pet food. It performs in liquids, bulk solids and slurries, including viscous (conductive or non-conductive) materials, even in challenging environments involving vapour and dust.

LC300 is a 2-wire instrument combining a sophisticated, yet easy-to-adjust, microprocessor transmitter with field-proven probes.

The electronic component contains the measurement module (driver) and the microprocessor module. This set of parts forms a calibrated pair that measures process capacitance in pico Farads (pF) which is proportional to the level of material in the tank. An optional safety barrier can be included in the electronic compartment for Hazardous Area applications.

The probe comprises a measurement section and an active shield section that is a fixed length. The probe is the primary system sensor, and it indicates the electrical capacitance value of the measurement section relative to the environment (tank wall, stilling well, or conductive material). This part of the probe connects to the electronic transmitter.

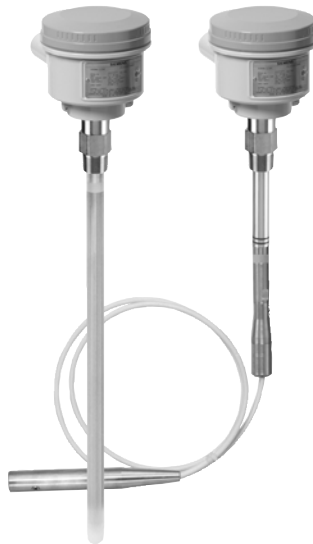



# Applications

- Mining and cement
- Power
- Food and beverage
- Water
- Chemical
- Oil and gas

# Features

- Threaded and flanged process connections: see “Process connections” on page 7
- Corrosion resistant construction, PFA, PEEK<sup>TM 1</sup>, and 316L stainless steel wetted parts
- 5 m (16.4 ft) maximum insertion length for rod versions and 25 m (82 ft) maximum insertion length for cable versions
- Rugged shear and abrasion resistant probe
- Fully adjustable range: level, damping, diagnostics, etc.
- Field adjustable insertion length for cable probes without PFA insulation
- Probe input ESD protected
- Field proven and patented Active-Shield technology and variable frequency oscillator

---

<sup>1</sup> PEEK is a registered trademark of Victrex plc.

# Technical Specifications

**Note:** Siemens makes every attempt to ensure the accuracy of these specifications, but reserves the right to change them at any time.

## Power

- Supply voltage 12-30 V DC any polarity, 2-wire current loop circuit, max. resistance value 550  $\Omega$  @ 24 V DC
- Measurement signal 4 – 20 mA or 20 – 4 mA according to NAMUR NE 43

## Environmental

- location indoor/outdoor
- altitude 2000 m max.
- ambient temperature general purpose applications:  
– 40 to +85 °C (– 40 to +185 °F)  
hazardous locations: refer to applicable certificate
- relative humidity suitable for outdoors (Type 4/NEMA 4/IP65 enclosure, IP68 optional)
- installation category I
- pollution degree 4

## Performance

- measurement range 1.66 pF to 3300 pF
- minimum span 3.3 pF
- accuracy < 0.5% of actual measurement value
- non-linearity and reproducibility < 0.4% full scale and actual measurement value
- temperature stability max. temperature drift of 0.25% of actual capacitance value
- safety
  - current signalling according to NAMUR NE 43, signal 3.8 to 20.5, fault  $\leq 3.6$  or  $\geq 21$  mA (22 mA)
  - probe input ESD protected
  - inputs/outputs fully galvanically isolated
  - polarity-insensitive current loop
- diagnostics<sup>1</sup>
  - primary variable (PV) out of measurement limits
  - failure in measurement circuit
  - memory check sum
  - system watch dog

<sup>1</sup> See Fault Values on page 30 for detailed descriptions of Diagnostic messages.

## Outputs

### Current loop

- continuous signal 4 to 20 mA / 20 to 4 mA

## User interface

### Display

- local LCD 4–digit (each digit can be 0 to 9 or limited alpha characters)

### Rotary switch

- menu position 0 Actual measurement value (in pF)
- menu position 1 Lower Range Value (LRV) 0% of scale value and adjustment
- menu position 2 Upper Range Value (URV) 100% of scale value and adjustment
- menu position 3 Actual mA signal and system fault setting according to NAMUR NE 43
- menu position 4 Diagnostic information/Software revision/reset
- menu position 5 Damping

## Electrodes

### Process connections<sup>1</sup>

- threaded rod mounting  $\frac{3}{4}$ " $\frac{1}{4}$ ",  $1\frac{1}{2}$ " NPT [(Taper), ANSI/ASME B1.20.1]  
R  $\frac{3}{4}$ " $\frac{1}{4}$ ",  $1\frac{1}{2}$ " [(BSPT), EN 10226; PT (JIS-T), JIS B 0203]  
G  $\frac{3}{4}$ " $\frac{1}{4}$ ",  $1\frac{1}{2}$ " [(BSPP), EN ISO 228-1; PF (JIS-P), JIS B 0202]
- threaded cable mounting  $1\frac{1}{2}$ " NPT [(Taper), ANSI/ASME B1.20.1]  
R  $1\frac{1}{2}$ " [(BSPT), EN 10226; PT (JIS-T), JIS B 0203]  
G  $1\frac{1}{2}$ " [(BSPP), EN ISO 228-1; PF (JIS-P), JIS B 0202]
- flange mounting 1 to 4" NPS [ASME B16.5]  
DN 25 to 100 [EN 1092-1]

<sup>1</sup>. Others available on request

	Diameter	Length	Active Shield <sup>a</sup>	Tensile (max)
rod probe	19 mm (0.75")	min. 300 mm (12") - max. 5000 mm (197")	120 mm for threaded process connections, 100 mm for flanged process connections	horizontal tensile load 30 Nm
cable probe	9 mm (0.35"), with PFA jacket 6 mm (0.24"), without PFA jacket	min. 1000 mm (39") - max. 25000 mm (984")	125 mm for threaded process connections, 105 mm for flanged process connections	1900kg (4188 lbs)

<sup>a</sup>Others available on request, "Dimensions" on page 10.

## Wetted Parts

- AISI 316L/PEEK<sup>TM</sup>/PFA<sup>1</sup>, FKM or FFKM o-ring

## Enclosure

- construction                      aluminium, epoxy coated
- ingress protection              Type 4/NEMA 4/IP65/IP68 optional
- cable inlet                         2 X M20 X 1.5 or 2 X ½" NPT

**Note:** The use of approved watertight conduit hubs/glands is required for Type 4/NEMA 4, Type 6/NEMA 6, IP68 (outdoor applications).

## Weight

- Depends on configuration.

<sup>1</sup>. For a chemical resistance list for PFA/PEEK, contact your local distributor.

## Process

### Note:

- Please see "SITRANS LC300 Pressure versus temperature curves" on page 34
- Not recommended for direct steam contact

- Pressure range<sup>1</sup> -1 to 35 bar g (-14.6 to 511 psi g)
- Temperature range -40 to 200 °C (-40 to 392 °F)

Hazardous Locations: Refer to applicable certificate

- Min. relative dielectric constant ( $\epsilon_r$ )1.5

## Approvals<sup>2</sup>

- General CSAus/c, FM, CE, C-TICK
- Hazardous

Dust Ignition Proof With Intrinsically Safe Probe:

(Europe) ATEX II 1/2 D T100 °C

(US/Canada) FM/CSA:

Class II, Div. 1, Groups E,FG

Class III T4

Flameproof With Intrinsically Safe Probe:

(Europe) ATEX II 1/2 G EEx d [ia] IIC T6...T1

ATEX II 1/2 D T100°C

(Brazil) BR-Ex d [ia] IIC T6...T1

Explosion Proof With Intrinsically Safe Probe:

(US/Canada) Class I, Div. 1, Groups A,B,C,D

Class II, Div. 1, Groups E,FG

Class III T4

- Marine Bureau Veritas Type Approval  
ABS Type Approval
- Overfill Protection AIB-Vincotte
- Other Pattern Approval (China)

<sup>1</sup>. See "SITRANS LC300 Pressure versus temperature curves" on page 34.

<sup>2</sup>. Please verify against device nameplate.

# Dimensions

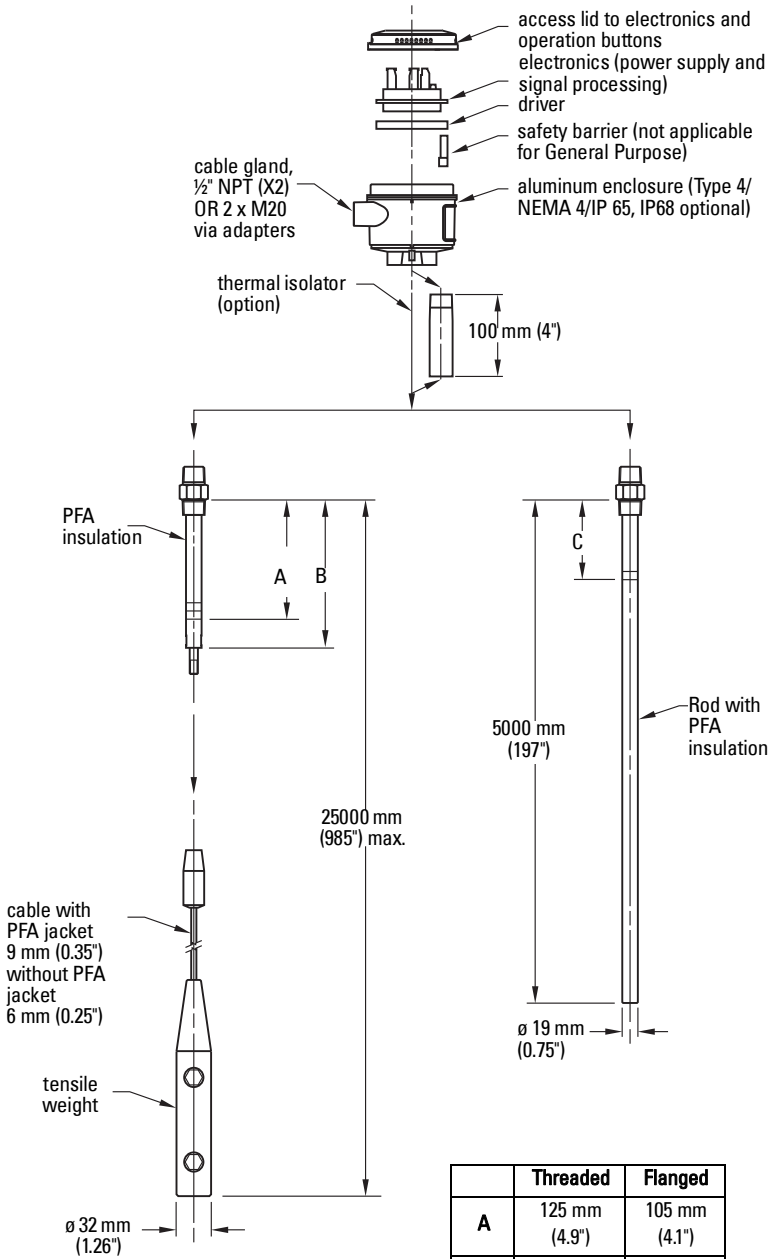

# Threaded rod version with PFA probe

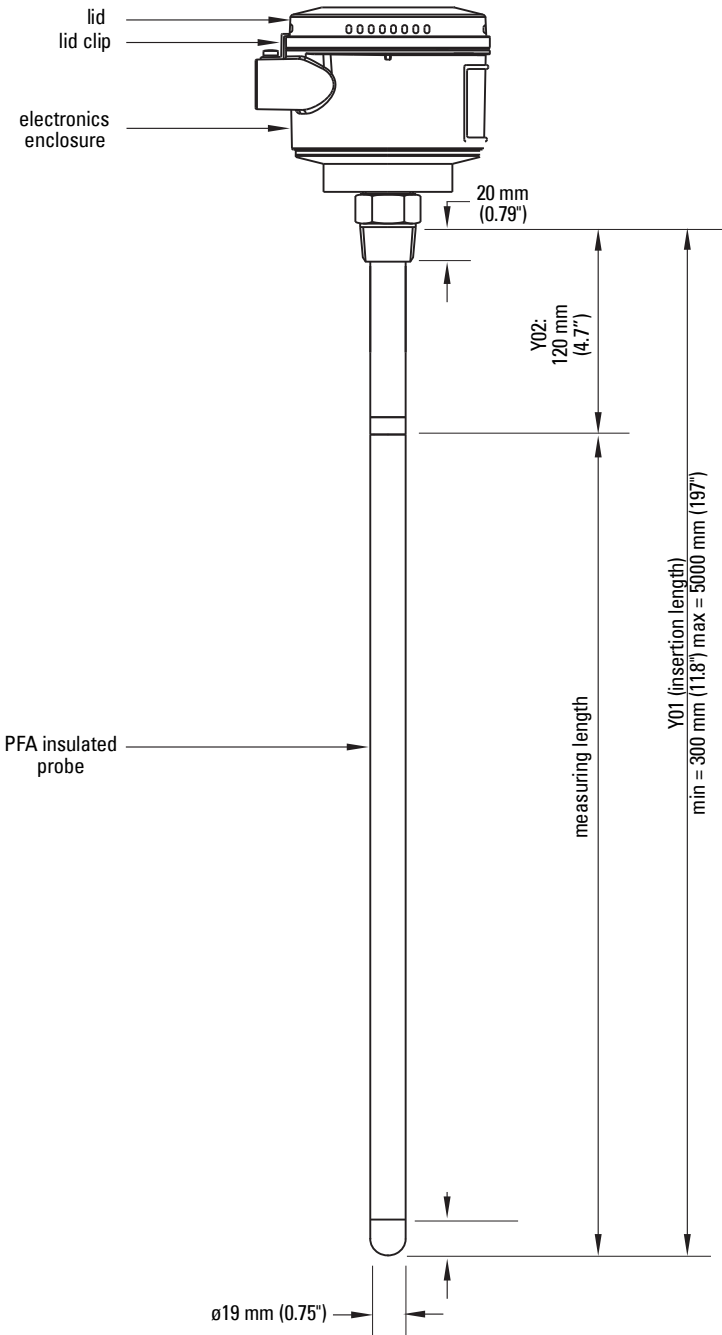

Dimensions

# Threaded rod version with PFA probe and stilling well

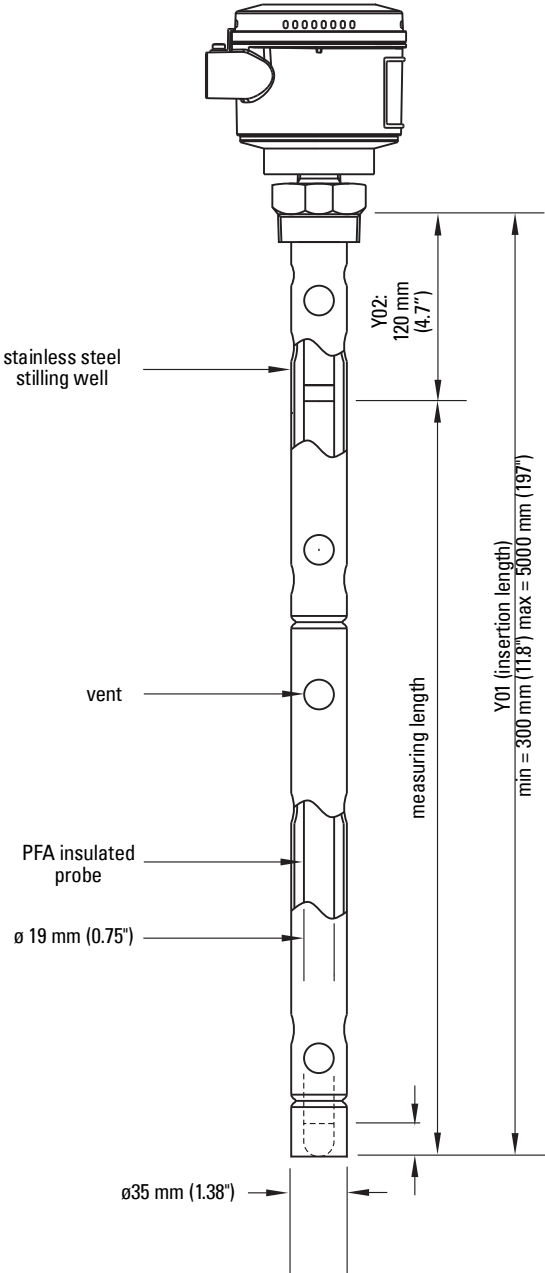

Dimensions



# Cable version, non-insulated, threaded

**Note:** For non-conductive applications only. Non-insulated cable can be shortened on site. Weight is included in measuring length.

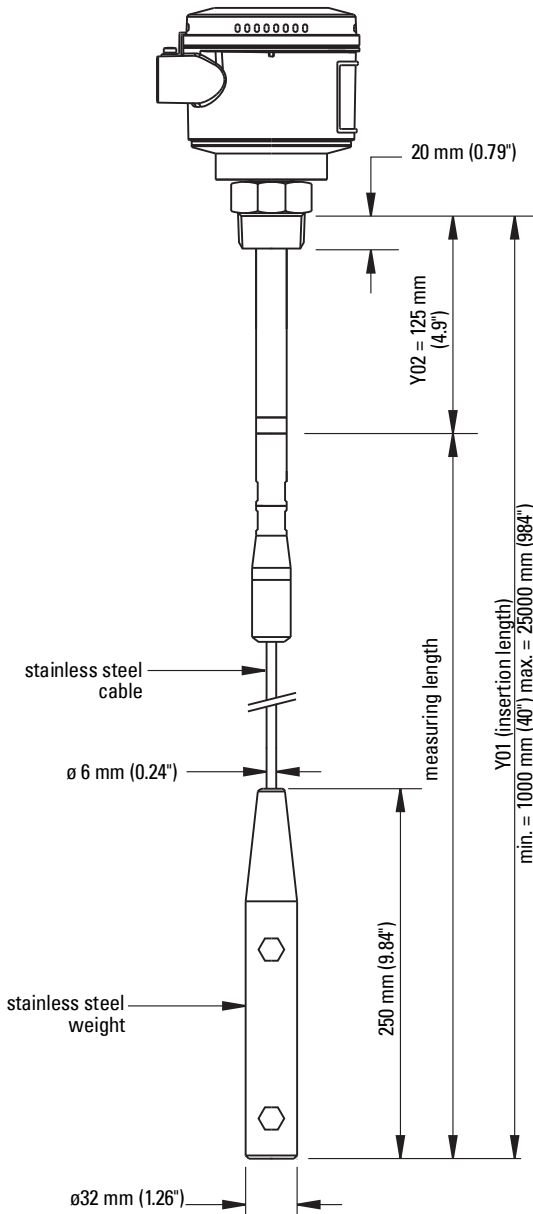

Dimensions

# Cable version, insulated, threaded

**Note:** For liquids and solids applications. Insulated cable cannot be shortened. Weight is **not** included in measuring length.

Dimensions

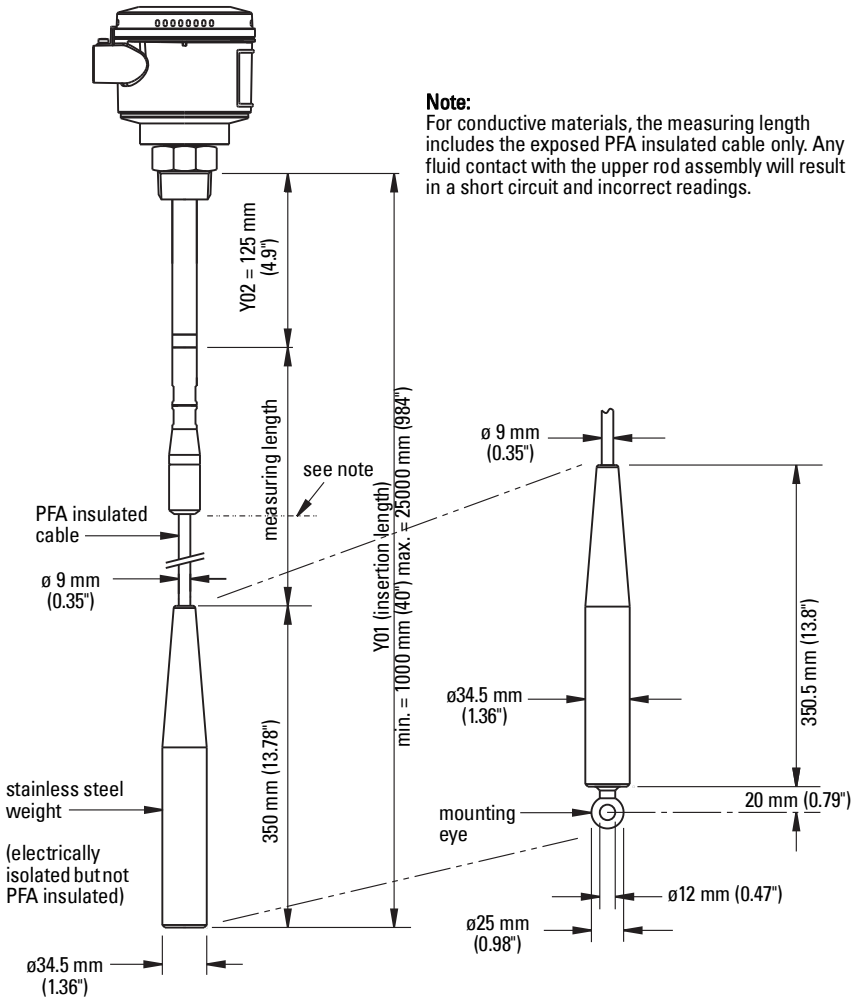

**Note:**

For conductive materials, the measuring length includes the exposed PFA insulated cable only. Any fluid contact with the upper rod assembly will result in a short circuit and incorrect readings.

# Welded flange

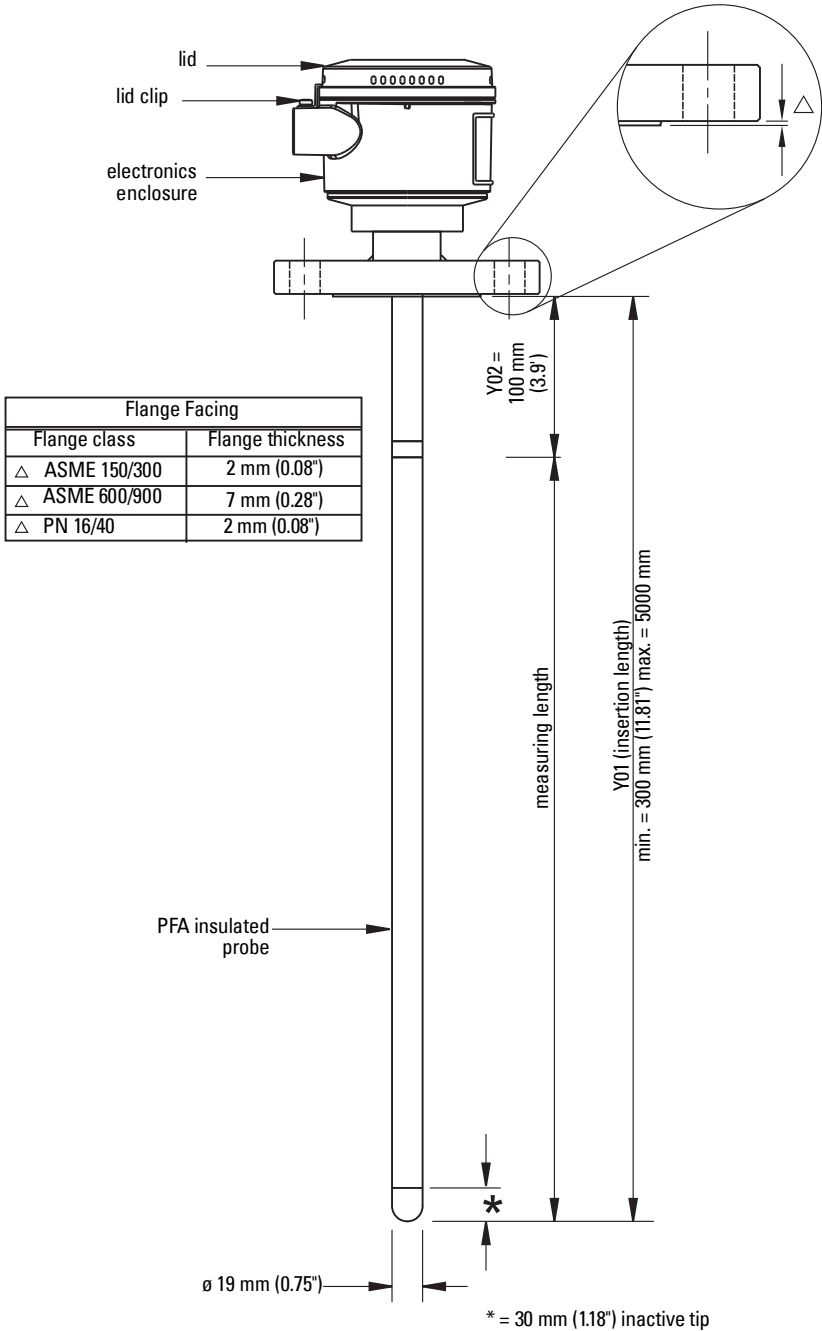

Dimensions

# Welded flange, threaded, with stilling well

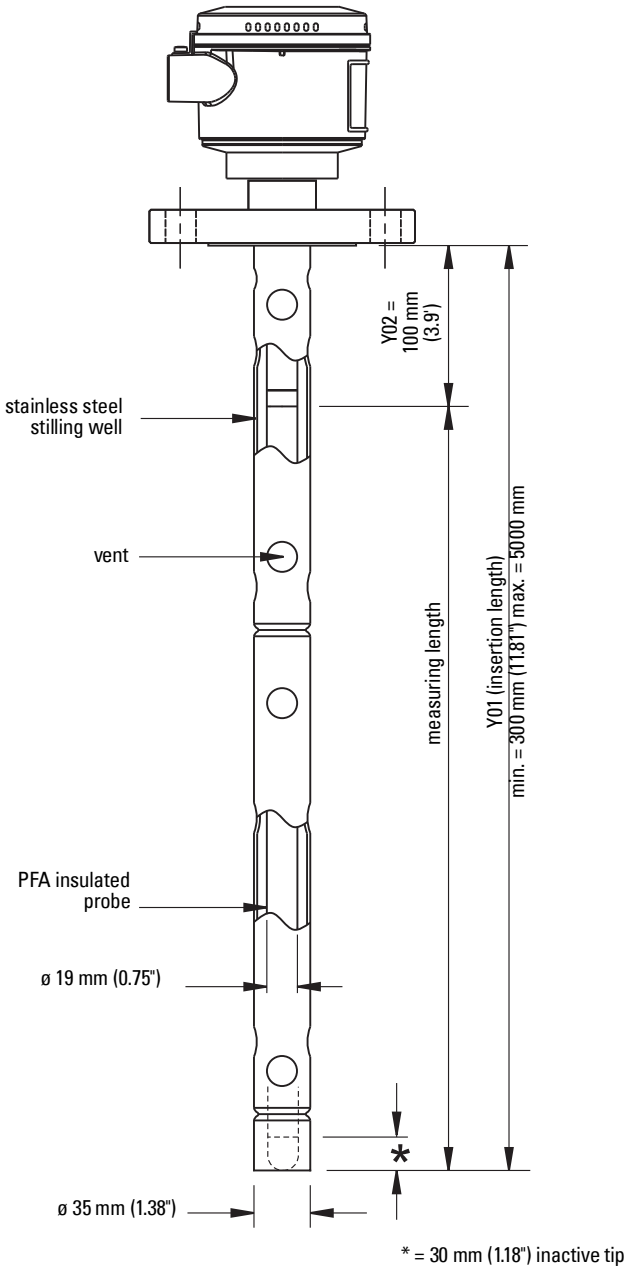

# Cable version, non-insulated, welded flange

**Note:** For non-conductive applications only. Non-insulated cable can be shortened on site. Weight is included in measuring length.

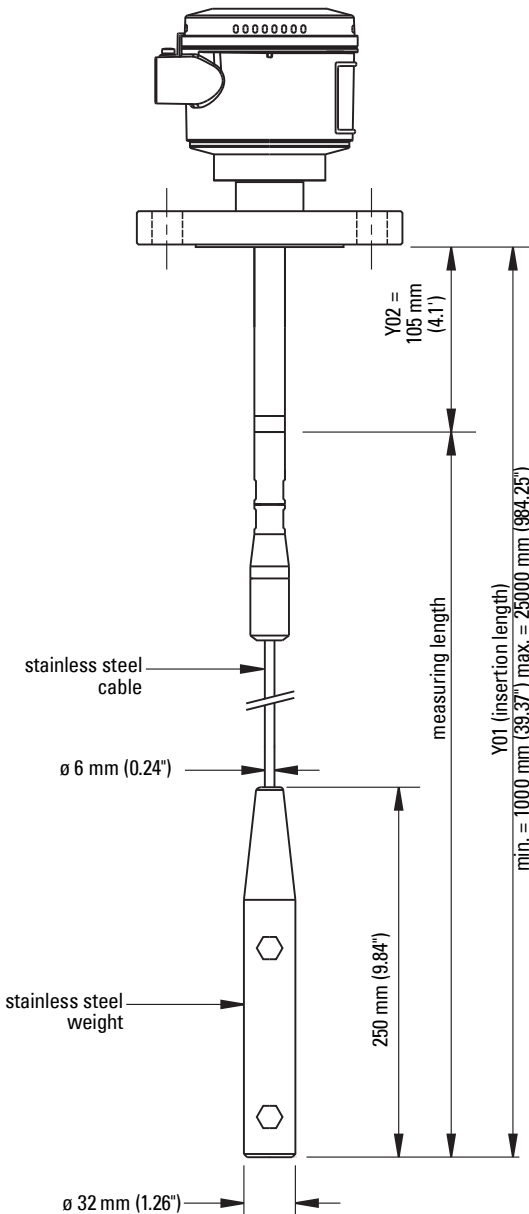

# Cable version, insulated, welded flange

**Note:** For liquids and solids applications. Insulated cable cannot be shortened. Weight is **not** included in measuring length.

Dimensions

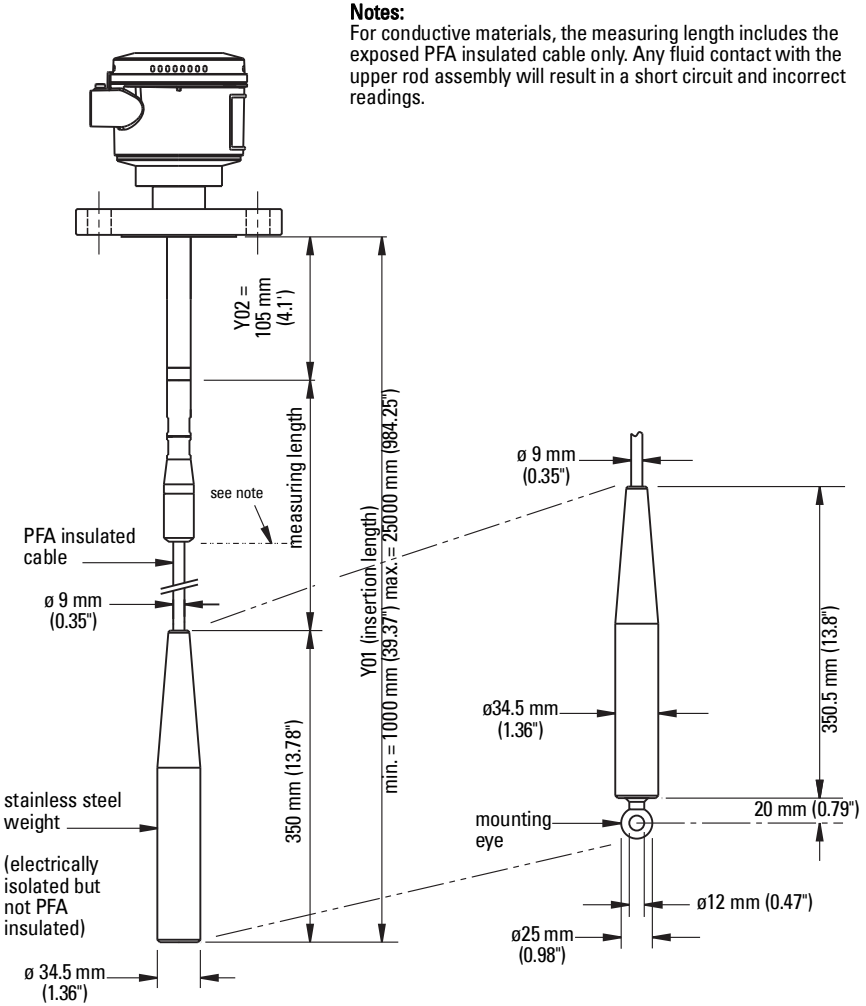

# Cable tensile strength

**CAUTION: Do not exceed the tensile strength of the cable at 1900 kg/4188 lbs.**

Always confirm that the load carrying capability of the silo/tank roof is sufficient to withstand the actual force on the cable conditions, especially where the force will be, or could be, as great as 1900 kg/4188 lbs. A cable probe with a PFA jacket reduces the amount of possible product build-up on the probe as well as the tensile force on the cable.

## Shortening the cable

### Methods

- An angle grinder (preferably with a disc suitable for stainless steel) or
- Wire cutters [suitable for piano cable  $\varnothing$  6 to 9 mm ( $\varnothing$  0.24 to 0.35")].

### Procedure

1. Loosen the three set screws and pull weight from the cable.
2. Grind/cut the cable to the required length, and then remove rough edges from the cable.
3. Ensure that cable strands are properly seated in the lay of the cable (i.e. no wire strands sticking outside the normal cable profile). Make sure **ALL** strands are properly seated before continuing the assembly.
4. Push the weight onto the cable while simultaneously **rotating it counter-clockwise** around the cable. Make sure that no cable strands are pushed out of their position in the cable and that the cable is fully inserted.
5. Re-fasten the weight by tightening the three set screws.

# Installation

## Location



### WARNINGS:

- Never attempt to loosen, remove or disassemble process connection or instrument housing while vessel contents under pressure.
- Installation shall be performed only by qualified personnel and in accordance with local governing regulations.
- This device is to be used only in the manner outlined in this manual. Otherwise, protection provided by the device may be impaired.
- Materials of construction are chosen based on their chemical compatibility (or inertness) for general purposes. For exposure to specific environments, check with chemical compatibility charts before installing.
- Improper installation may result in loss of process pressure.
- Handle the device using the enclosure, not the antenna or the device tag, to avoid damage.

### Notes:

- Refer to the device nameplate for approval information.
- SITRANS LC300 units are pressure tested, meeting or exceeding the requirements of the ASME Boiler and Pressure Vessel Code and the European Pressure Equipment Directive.
- The serial numbers stamped in each process connection body provides a unique identification number indicating date of manufacture.
- Example: MMDDYY - XXX (where MM = month, DD = day, YY = year, and XXX = sequential unit produced)
- Further markings (space permitting) indicate flange configuration, size, pressure class, material, and material heat code.
- This product is susceptible to electrostatic shock. Follow proper grounding procedures.

## Pressure Equipment Directive, PED, 97/23/EC

Siemens Level Transmitters with flanged, threaded, or sanitary clamp type process mounts have no pressure-bearing housing of their own, and therefore do not come under the Pressure Equipment Directive as pressure nor safety accessories (see EU Commission Guideline 1/8 and 1/20).

SITRANS LC300 as supplied in the standard probe lengths is normally mounted on the vessel top or through the tank wall at the detection level (if used as Point Level switch).

The cable version is designed for top mounting. The cable suspends vertically so that it reaches into the process with the end of the cable being the start of the measurement (dependant on probe option).



# Mounting



## WARNINGS:

- Never attempt to loosen, remove or disassemble process connection or instrument housing while vessel contents under pressure.
- The user is responsible for the selection of bolting and gasket materials which will fall within the limits of the flange and its intended use, and which are suitable for the service conditions.
- The use of PTFE tape or other appropriate sealant may be used to aid in sealing the threads for use in pressure applications.

## Notes:

- Before inserting the instrument into its mounting connection, check to ensure the threads are matching to avoid damaging them.
- Simply screw the instrument into the process connection and tighten.

## Multiple units and wall restriction

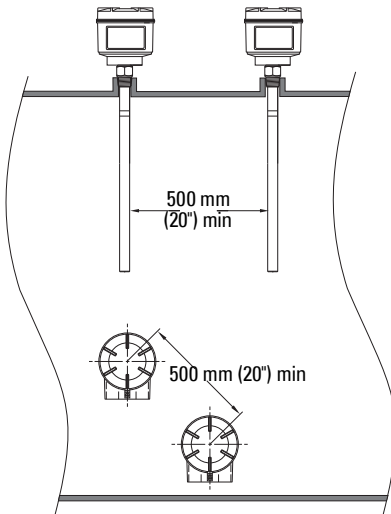

Horizontally mounted units are configured as point level switches. Mount diagonally if vertical space is restricted.

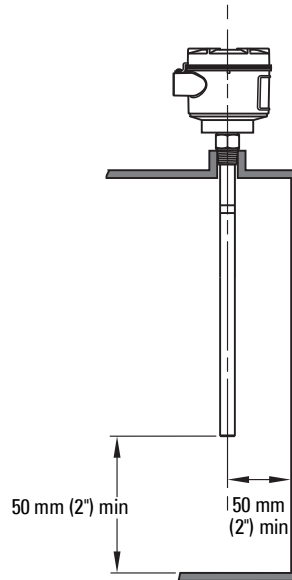

## Note:

- These drawings are not to scale.

# Process cautions

**Caution:** Keep unit out of path of falling material.

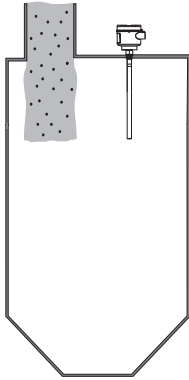

**Caution:** Consider material surface configuration when installing unit.

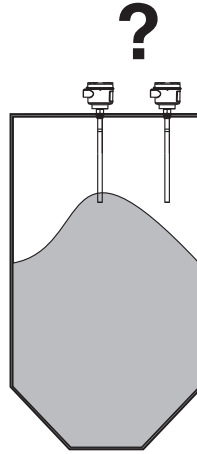

**Caution:** Tensile load must not exceed probe or vessel rating.

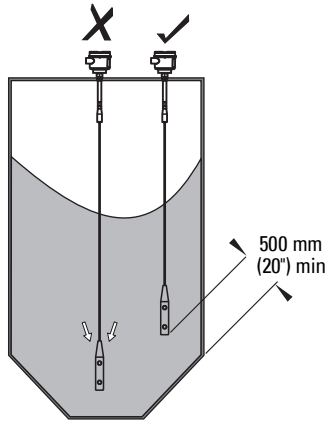

**Note:** Buildup of material or condensation in active shield area does not affect operation.

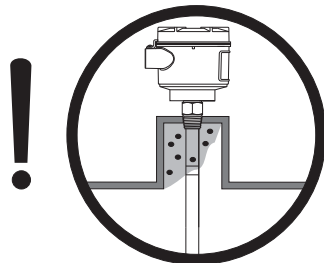
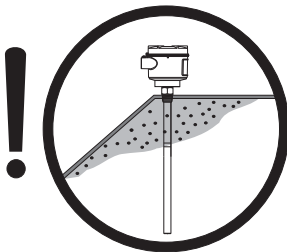

# Wiring



## WARNINGS:

- Check the device nameplate and process device tag to verify the approval rating.
- Use appropriate conduit seals to maintain IP or NEMA rating.
- Read *Instructions specific to hazardous area installations* on page 26

## Signal amplifier/power supply

SITRANS LC300 uses a switched power supply circuit that makes the most efficient use of the available power present on the terminals. If the signal current is low (4 mA), the terminal voltage will increase due to a voltage drop of other components in the loop, and if the signal current is high (20 mA), the terminal voltage will decrease.

Loosen the lid clip and remove the enclosure cover to access connectors and electronics.

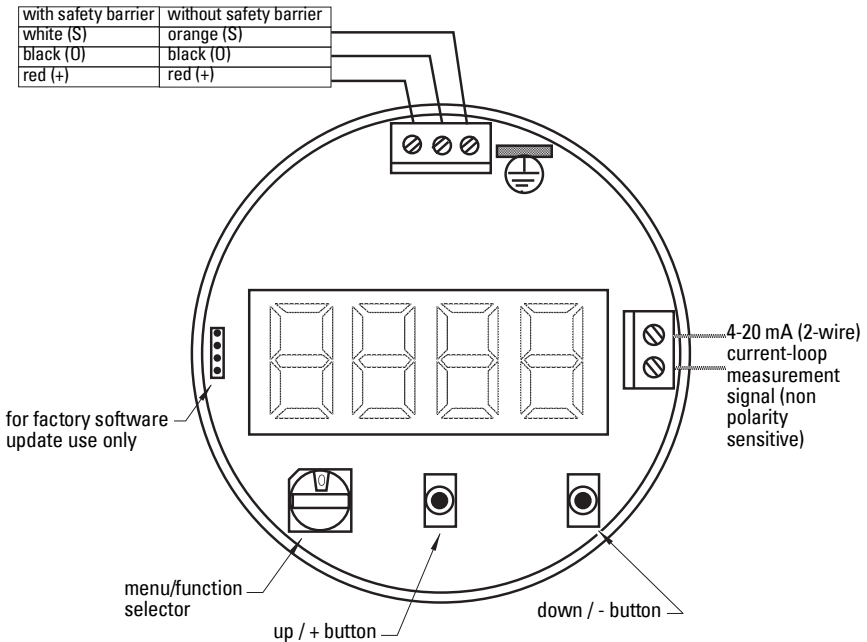

# Connecting the SITRANS LC300

1. Loosen the retaining lid clip and remove the enclosure cover.
2. Loosen the cable gland and thread the cable through it.
3. Connect the power/signal conductor wires to the current-loop terminal blocks (any polarity). The loop voltage must be between 12 and 30 V DC.
4. Ground the enclosure by connecting the housing and the process connection with either the stilling well and/or the tank wall, using the ground lug near the bottom of the housing.
5. Check that all connections are secure.
6. Replace enclosure cover and tighten retaining lid clip.



**! WARNING:** The sensor terminal block connects the electronics to the measurement module, providing the supply voltage and receiving the frequency signal from the measurement. The user should not alter these connections.

## Product nameplates

**Note:** Information in boxes 1 through 6 based on customer order.

**SIEMENS**



SITRANS LC300  
7MLxxxx-xxxxx-xxxx [BOX 1]  
Serial No.: GYZ / S1034567  
Input: 12 – 30 V ===,  
Amb. Temp.: – 40 °C to 85 °C  
Enc.: [BOX 1]  
Cable Entry: [BOX 2]  
Output: 3.6 – 22.0 mA

 KEMA 00ATEX2040 X  
 [BOX 2] 

Use Suitably Rated Cable If Ambient Temp. > 70 °C  
Do Not Open When An Explosive Dust Atmosphere Is Present  
Siemens Milltronics Process Instruments Inc.

**SIEMENS**



SITRANS LC300  
7MLxxxx-xxxxx-xxxx [BOX 1]  
Serial No.: GYZ / S1034567  
Input: 12 – 30 V ===,  
Enc.: [BOX 1]  
Cable Entry: [BOX 2]  
Output: 3.6 – 22.0 mA

 KEMA 00ATEX2040 X  
 [BOX 2] 

Use Suitably Rated Cable If Ambient Temp. > 70 °C  
Refer To Applicable Certificate For Temp. Rating  
Do Not Open When An Explosive Atmosphere Is Present  
Siemens Milltronics Process Instruments Inc.

**SIEMENS**



SITRANS LC300  
7MLxxxx-xxxxx-xxxx [BOX 1]  
Serial No.: GYZ / S1034567  
Input: 12 – 30 V ===,  
Amb. Temp.: – 40 °C to 85 °C  
Enc.: [BOX 1]  
Cable Entry: [BOX 2]  
Output: 3.6 – 22.0 mA

   
Class II, Div 1, Gr. E, F, G  
Class III 14

Do Not Open When An Explosive Dust Atmosphere Is Present  
Siemens Milltronics Process Instruments Inc.

**SIEMENS**

SITRANS LC300  
7MLxxxx-xxxxx-xxxx [BOX 1]  
Serial No.: GYZ / S1034567  
Input: 12 – 30 V ===,  
Amb. Temp.: – 40 °C to 85 °C  
Enc.: [BOX 1]  
Cable Entry: [BOX 2]  
Output: 3.6 – 22.0 mA

   
Class I, Div 1, Gr. A, B, C, D  
Class II, Div 1, Gr. E, F, G  
Class III 14  
Seal Conduit < 18 inches

Use Suitably Rated Cable If Ambient Temp. > 70 °C  
Do Not Open When An Explosive Atmosphere Is Present  
Siemens Milltronics Process Instruments Inc.

## Wiring setups for hazardous area installations

**! WARNINGS:**

- Turn off power before servicing any device.
- Please check the ambient and operating temperatures under *Environmental* on page 6, and *Process* on page 9 for the specific configuration you are about to use or install.
- In potentially explosive atmospheres:
  - open the enclosure only when SITRANS LC300 is not energized.

**Note:** The transmitter is in operation when the power supply is switched on.

# Flameproof / explosion proof configuration in hazardous areas

## ATEX

Maximum permissible ambient temperature range in potentially explosive atmospheres:

For category II 1 G:

–20 °C to maximum +60 °C (–4 °F to maximum +140 °F)

For category II 2 G:

–40 °C to maximum +85 °C (–40 °F to maximum +185 °F): T1

–40 °C to maximum +85 °C (–40 °F to maximum +185 °F): T2

–40 °C to maximum +85 °C (–40 °F to maximum +185 °F): T3

–40 °C to maximum +85 °C (–40 °F to maximum +185 °F): T4

–40 °C to maximum +85 °C (–40 °F to maximum +185 °F): T5

–40 °C to maximum +70 °C (–40 °F to maximum +158 °F): T6

- Maximum permissible process temperature range in potentially explosive atmospheres:

For category II 1 G:

–20 °C to maximum +60 °C (–4 °F to maximum +140 °F)

For category II 2 G:

–40 °C to maximum +400 °C (–40 °F to maximum +752 °F): T1

–40 °C to maximum +300 °C (–40 °F to maximum +572 °F): T2

–40 °C to maximum +200 °C (–40 °F to maximum +392 °F): T3

–40 °C to maximum +135 °C (–40 °F to maximum +275 °F): T4

–40 °C to maximum +100 °C (–40 °F to maximum +212 °F): T5

–40 °C to maximum +80 °C (–40 °F to maximum +176 °F): T6

## CSA/FM

- Maximum permissible ambient temperature range in potentially explosive atmospheres:

–40 °C to maximum +85 °C (–40 °F to maximum +185 °F): T4

- Maximum permissible process temperature range in potentially explosive atmospheres:

–40 °C to maximum +200 °C (–40 °F to maximum + 392 °F)

–40 °C to maximum +400 °C (–40 °F to maximum +752 °F):

high temperature version

# Instructions specific to hazardous area installations

## (Reference European ATEX Directive 94/9/EC, Annex II, 1/0/6)

The following instructions apply to equipment covered by certificate number KEMA 00ATEX2040X:

1. For use and assembly, refer to the main instructions.
2. The equipment is certified for use as Category 1/2G, 1/2D. Refer to appropriate certificate.
3. Refer to appropriate certificate for application in specific hazardous environment.
4. Refer to appropriate certificate for ambient temperature range.
5. The equipment has not been assessed as a safety related device (as referred to by Directive 94/9/EC Annex II, clause 1.5).
6. Installation and inspection of this equipment shall be carried out by suitably trained personnel in accordance with the applicable code of practice (EN 60079-14 and EN 60079-17 in Europe).
7. Repair of this equipment shall be carried out by suitably trained personnel in accordance with the applicable code of practice (e.g. EN 60079-19 within Europe).
8. Components to be incorporated into or used as replacements in the equipment shall be fitted by suitably trained personnel in accordance with the manufacturer's documentation.
9. The certificate numbers have an 'X' suffix, which indicates that special conditions for safe use apply. Those installing or inspecting this equipment must have access to the certificates.
10. If the equipment is likely to come into contact with aggressive substances, then it is the responsibility of the user to take suitable precautions that prevent it from being adversely affected, thus ensuring that the type of protection is not compromised.

Aggressive substances: e.g. acidic liquids or gases that may attack metals, or solvents that may affect polymeric materials.

Suitable precautions: e.g. establishing from the material's data sheet that it is resistant to specific chemicals.

**Note:** Please see [www.siemens.com/level](http://www.siemens.com/level) for the latest approval certificates.

# Operation

## Start up

SITRANS LC300 user interface comprises the liquid crystal display (LCD), the 6-position rotary switch, and two push-buttons. Select a menu using the rotary switch; select and/or alter a readout or value using the push-buttons.

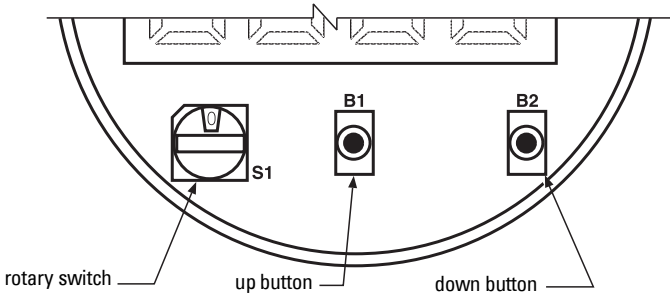

The rotary switch can be set from 0 to 5. Each position represents a menu. The position wraps from 5 to 0.

The LCD (liquid crystal) displays settings altered by the rotary switch and the push-buttons.

## Menu functions

Rotary switch position	0	1	2	3	4	5
Display	Read PV (pF)	Read LRV (pF) (0% level)	Read URV (pF) (100% level)	Read mA loop-current	Diagnostics	Damping
Up button		Increase LRV	Increase URV	Set fault protection setting to 22 mA	Product version	Increase damping
Down button		Decrease LRV	Decrease URV	Set fault protection setting to 3.6 mA		Decrease damping
Both buttons		Set LRV from PV	Set URV from PV	Disable fault protection	Reset/Acknowledge Fault	Set damping to <b>1.00</b>

When you turn the rotary switch, the LCD shows the new menu selection for about 1 second followed by the data for that selection. When you alter a read-out or value, a colon (:) is displayed when the debounce delay timer has expired and the new value has been accepted.

Menu positions 0 (primary variable in pF) and 3 (corresponding loop-current values in mA) are the recommended positions during normal operation.

## Menu position 0

<b>Display</b>	<ul style="list-style-type: none"> <li>• LCD displays the PV (Primary Variable) in pF.</li> <li>• In case of a system fault, the display alternates between PV value and <b>Fit</b>. View the fault details in menu <b>4</b>.</li> <li>• Pressing either or both push-buttons in menu 0 has no effect.</li> </ul>
----------------	---

## Menu position 1

<b>Display</b>	<ul style="list-style-type: none"> <li>• LCD displays the LRV (Lower Range Value) in pF, occurring when the range is at 0% and the loop-current is set to 4 mA.</li> </ul>
<b>Up button</b>	<ul style="list-style-type: none"> <li>• Pressing the Up button for less than 1 second adjusts the LRV in the current step size (initially 0.01 pF).</li> <li>• Holding the Up or Down buttons for more than 1 second increases the step size to 0.1 pF. If you continue to hold the button, the step size increases to 10, 100, and 1000 (displayed as 1E3). When no button is pressed for 4 seconds, the step size decreases to the next smallest value. At each step size, press the buttons for less than 1 second to adjust the value.</li> </ul>
<b>Down button</b>	<ul style="list-style-type: none"> <li>• Pressing the Down button for less than 1 second decreases the LRV in the current step size (initially 0.01 pF).</li> <li>• When held for more than 1 second, the Down Button will increase the step size by 0.1, 10, 100, and 1000. When no button is pressed for 4 seconds, the step size decreases to the next smallest value.</li> </ul>
<b>Both buttons</b>	<ul style="list-style-type: none"> <li>• Pressing both buttons for more than 1 second sets the LRV to the current PV value.</li> </ul>

## Menu position 2

<b>Display</b>	<ul style="list-style-type: none"> <li>• LCD displays the URV (Upper Range Value) in pF, occurring when the range is at 100% and the loop-current is set to 20 mA.</li> </ul>
<b>Up button</b>	<ul style="list-style-type: none"> <li>• Pressing the Up button for less than 1 second adjusts the URV in the current step size (initially 0.01 pF).</li> <li>• Holding the Up or Down buttons for more than 1 second increases the step size to 0.1 pF. If you continue to hold the button, the step size increases to 10, 100, and 1000 (displayed as 1E3). When no button is pressed for 4 seconds, the step size decreases to the next smallest value. At each step size, press the buttons for less than 1 second to adjust the value.</li> </ul>



<b>Down button</b>	<ul style="list-style-type: none"> <li>Pressing the Down button for less than 1 second decreases the URV in the current step size (initially 0.01 pF).</li> <li>When held for more than 1 second, the Down Button will increase the step size by 0.1, 10, 100, and 1000. When no button is pressed for 4 seconds, the step size decreases to the next smallest value.</li> </ul>
<b>Both buttons</b>	<ul style="list-style-type: none"> <li>Pressing both buttons for more than 1 second sets the URV to the current PV value.</li> </ul>

## Menu position 3

Position 3 displays the Analog signal as it is set for the loop current. The Up and Down buttons set the system fault protection settings (according to NAMUR NE 43). System fault protection is used by control equipment to determine whether or not the LC300 is presenting a reliable signal.

When a system fault occurs:

Position 3 fault protection setting	Menu 3 LCD display	Current signal to D.C.S	Menu 0 reading
C:Hi	22 mA	22 mA	pF reading
C:Lo	3.6 mA	3.6 mA	alternating with FLT
C:An	mA value at time of fault	none	pF reading

<b>Display</b>	<ul style="list-style-type: none"> <li>LCD shows the Analog Signal as it is set for the loop-current in mA. Normal primary variables would give mA values between 3.8 mA (lower saturation point) and 20.5 mA (upper saturation point).</li> <li>When the reading goes above the URV or below the LRV but still within the measurement range of the unit, it will remain at 20.5 or 3.8 respectively until the level returns between URV and LRV.</li> </ul>
<b>Up button</b>	<ul style="list-style-type: none"> <li>Pressing the Up button for less than 1 second shows the system fault protection setting.</li> <li>Holding the Up button for longer than 1 second will change the fault protection setting to <b>C:Hi</b>.<sup>a</sup></li> </ul>
<b>Down button</b>	<ul style="list-style-type: none"> <li>Pressing the Down button for less than 1 second shows the system fault protection setting.</li> <li>Holding the Down button for longer than 1 second will change the fault protection setting to <b>C:Lo</b>.</li> </ul>
<b>Both buttons</b>	<ul style="list-style-type: none"> <li>Pressing both buttons for more than 1 second disables the system fault protection and the LCD will read <b>C:An</b>.</li> </ul>

<sup>a</sup>. System errors that would trigger a fault are a checksum error, an absence of measurement signal, or a primary variable beyond 1.66 pF (low) or 3300 pF (high).

## Menu position 4

<b>Display</b>	<ul style="list-style-type: none"> <li>LCD shows diagnostic information. A correctly operating device shows 0.00 on the LCD. See chart below for explanation of system fault values.</li> </ul>
<b>Up button</b>	<ul style="list-style-type: none"> <li>LCD shows revision information. Please note this information when calling Siemens Milltronics representatives for assistance.</li> </ul>
<b>Both buttons</b>	<ul style="list-style-type: none"> <li>Holding both buttons for more than 1 second will try to reset the error status. The LCD reads 0.00 when the status has been successfully reset. Monitor the LC300 more closely after a diagnostic error has occurred.</li> </ul>

### Fault values

<b>128</b>	The device is in calibration mode. The measurement values and the loop-current setting may no longer be trusted.
<b>64</b>	A checksum error has occurred in the program and/or data memory. The measurement values and the loop-current setting may no longer be trusted.
<b>32</b>	LC300 system watchdog has been activated. This fault can be combined with fault 64, resulting in fault 96. The measurement values and the loop-current setting may no longer be trusted.
<b>8</b>	An arithmetic error has occurred, perhaps caused by an incorrect value setting. This event type error will rarely affect the operation of the LC300.
<b>4</b>	An error occurred while trying to store settings in the local non-volatile memory. The LC300 may not operate correctly.
<b>2</b>	The primary variable has exceeded the device limits (1.66 pF and 3300 pF). Check that the probe is correctly connected to the measurement module.
<b>1</b>	The measurement circuit no longer emits signal. Check the wiring to/from the measurement module or barrier circuit.

**Note:** It is possible for more than one fault to occur at the same time. The display will read the combined result of both fault values. For example: If fault value 1 and fault value 2 occur together, the display will read fault value 3. If the display reads fault value 10, it means fault value 8 and fault value 2 have occurred together.

# Menu position 5

<b>Display</b>	<ul style="list-style-type: none"> <li>LCD shows the damping value. The damping value alters the speed at which the primary variable will track the signal from the probe.</li> </ul>
<b>Up button</b>	<ul style="list-style-type: none"> <li>Pressing Up button for less than 1 second increases the damping value in 0.01 steps. Damping can be set to any value from 1.0 to 1000.0</li> <li>Holding the Up or Down buttons for more than 1 second increases the step size to 0.1. If you continue to hold the button, the step size increases to 10, 100, and 1000 (displayed as 1E3). When no button is pressed for 4 seconds, the step size decreases to the next smallest value. At each step size, press the buttons for less than 1 second to adjust the value.</li> </ul>
<b>Down button</b>	<ul style="list-style-type: none"> <li>Pressing Down button for less than 1 second decreases the damping value in 0.01 steps. Damping can be set to any value from 1.0 to 1000.0</li> <li>When held for more than 1 second, the Down Button will increase the step size by 0.1, 10, 100, and 1000. When no button is pressed for 4 seconds, the step size decreases to the next smallest value. At each step size, press the buttons for less than 1 second to adjust the value.</li> </ul>
<b>Both buttons</b>	<ul style="list-style-type: none"> <li>Holding both buttons for more than 1 second sets the damping value back to 1.0 (default).</li> </ul>

## Recommissioning

LC300 should be recommissioned whenever the transmitter or probes are replaced.

LC300 LRV will be programmed as factory default. The LRV can be re-adjusted in menu 1.

<b>Setting URV</b>	
<b>If probe is fully covered in application:</b>	
Set URV by pressing both buttons for more than 1 second in menu 2 when probe is fully covered.	
<b>If probe is rarely or never fully covered, set the LC300 to your application based on the following example:</b>	
<b>LRV (0%)</b>	Menu 1 reads <b>12.5 pF</b>
Actual level is at 45% of the measurement length of probe:	
<b>PV (45%)</b>	Menu 0 reads <b>37 pF</b>
The correct setting for URV:	
<b>URV =</b>	$\frac{[(PV - LRV) * 100 / \text{actual level in \%}] + LRV}{[(37 - 12.5) * 100 / 45] + 12.5}$ <p style="margin-left: 20px;"><b>= 66.94 pF</b></p>
When calculating the URV, best results are achieved when using the highest possible actual level.	

# Maintenance

LC300 requires no regular maintenance or cleaning.

**Note:** Build-up of material on the active shield area has little or no effect on the performance of the LC300.

## Unit repair and excluded liability

All changes and repairs must be done by qualified personnel, and applicable safety regulations must be followed. Please note the following:

- The user is responsible for all changes and repairs made to the device.
- All new components must be provided by Siemens Milltronics Process Instruments Inc.
- Restrict repair to faulty components only.
- Do not re-use faulty components.

# Appendix A: Technical References

---



## **WARNINGS:**

- Never attempt to loosen, remove or disassemble process connection or instrument housing while vessel contents under pressure.
- Installation shall be performed only by qualified personnel and in accordance with local governing regulations.
- This device is to be used only in the manner outlined in this manual. Otherwise, protection provided by the device may be impaired.
- Materials of construction are chosen based on their chemical compatibility (or inertness) for general purposes. For exposure to specific environments, check with chemical compatibility charts before installing.
- Improper installation may result in loss of process pressure.
- Handle the device using the enclosure, not the antenna or the device tag, to avoid damage.

## **Notes:**

- Refer to the device nameplate for approval information.
- SITRANS LC300 units are pressure tested, meeting or exceeding the requirements of the ASME Boiler and Pressure Vessel Code and the European Pressure Equipment Directive.
- The serial numbers stamped in each process connection body provides a unique identification number indicating date of manufacture.
- Example: MMDDYY - XXX (where MM = month, DD = day, YY = year, and XXX = sequential unit produced)
- Further markings (space permitting) indicate flange configuration, size, pressure class, material, and material heat code.
- This product is susceptible to electrostatic shock. Follow proper grounding procedures.

# SITRANS LC300 Pressure versus temperature curves

## LC300 Standard, extended rod, and cable versions, threaded



### WARNINGS:

- For pressure applications, use PTFE tape or other appropriate thread sealing compound and tighten the process connection beyond hand-tight.
- The use of PTFE tape or other appropriate sealant may be used to aid in sealing the threads for use in pressure applications.

### Notes:

- Before inserting the instrument into its mounting connection, check to ensure the threads are matching to avoid damaging them.
- Simply screw the instrument into the process connection and tighten.

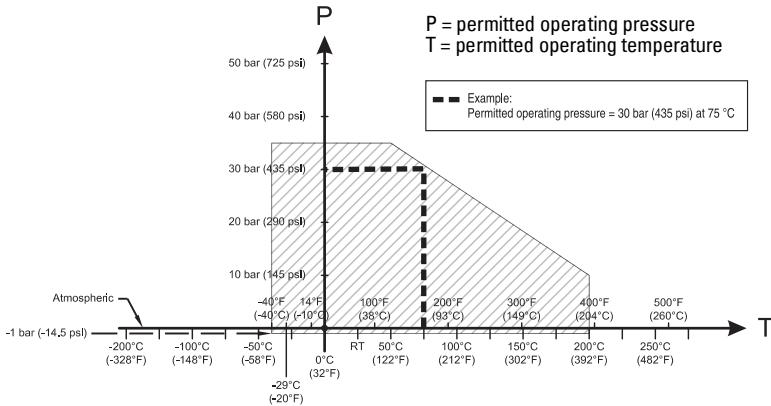

# LC300 Standard, extended rod, and cable versions, ASME flanged

## ! WARNINGS:

- The user is responsible for the selection of bolting and gasket materials which will fall within the limits of the flange and its intended use, and which are suitable for the service conditions.

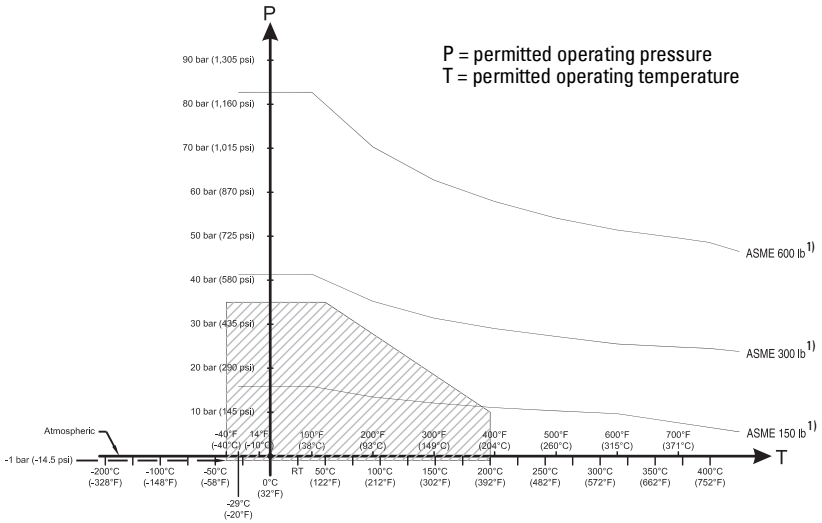

1) The curve denotes the minimum allowable flange class for the shaded area below.

# LC300 Standard, extended rod, and cable versions, EN flanged

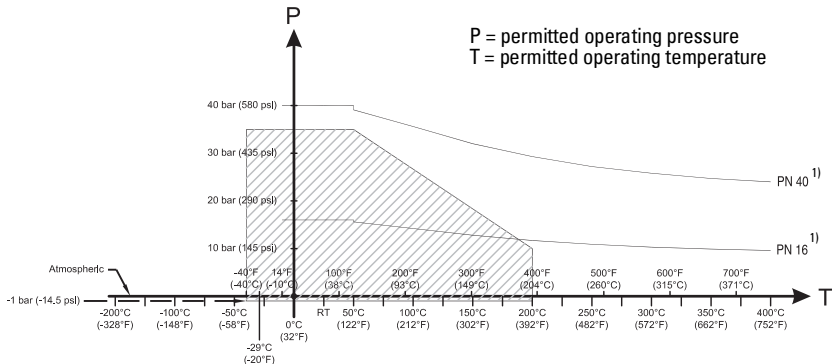

1) The curve denotes the minimum allowable flange class for the shaded area below.

A: Technical Reference

# Index

---

## A

- abbreviations
  - list 3
- accuracy 6
- analog signal 29
- appendix
  - application notes 33
- applications 5
- approvals 9

## B

- build-up 32

## C

- cable
  - shortening 19
  - tensile strength 19
- configuration 10
- connections 24

## D

- damping value 31
- diagnostics 30
  - fault values 30
- dimensions 10
  - cable 13, 14, 15, 16, 17, 18
  - standard 11, 12
- display 7

## F

- fault values 30
- features 5

## I

- identifications
  - list 3
- installation
  - location 20
- interconnection
  - signal amplifier 23
- introduction to SITRANS LC 300 4

## L

- lower range value 28
- LRV 28

## M

- maintenance 32
- menu
  - position 0 28
  - position 1 28
  - position 2 28
  - position 3 29

position 4 30

position 5 31

- mounting 21
  - multiple units 21, 22

## O

- operation 27

## P

- position 0 28
- position 1 28
- position 2 28
- position 3 29
- position 4 30
- position 5 31
- power supply 6
- primary variable 28
- probes 8
- process cautions 22
- process connection 7

## R

- recommissioning 31

## S

- signal amplifier 23
- SITRANS LC 300
  - applications 5
  - configuration 10
  - features 5
- start up 27
- system fault protection 29

## T

- transmitter 6

## U

- upper range value 28
- URV 28



## For more information

[www.siemens.com/level](http://www.siemens.com/level)

[www.siemens.com/continuous-weighing](http://www.siemens.com/continuous-weighing)

Siemens Milltronics Process Instruments Inc.  
Industry Automation (IA)  
1954 Technology Drive  
P.O. Box 4225  
Peterborough, ON  
Canada K9J 7B1

email: [techpubs.smpi@siemens.com](mailto:techpubs.smpi@siemens.com)

[www.siemens.com/processautomation](http://www.siemens.com/processautomation)

Subject to change without prior notice  
Rev. 2.0

© Siemens Milltronics Process Instruments Inc. 2010



Printed in Canada