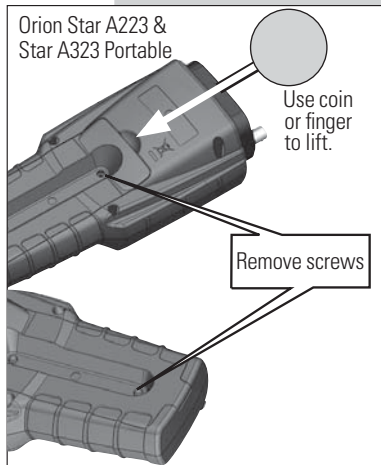

Instruction Sheet

Preparation**Power Source**

1. Power adapter (sold separately)
 - a. Select the appropriate wall socket plug plate.
 - b. Slide off the clear plastic cover from the plug plate.
 - c. Slide the plug plate into the groove on the back of the power adapter.
 - d. Connect the power adapter to the meter and power outlet.
2. Batteries (included with meter)
 - a. Select four AA alkaline batteries.
 - b. Confirm that the meter is powered off.
 - c. Remove the battery compartment cover – loosen the screws holding the battery cover, release the top portion of the battery cover from the meter (use a coin or your finger) and release the bottom portion of the battery cover.
 - d. Orientate the batteries as shown in the battery compartment housing and insert batteries.
 - e. Replace the battery compartment cover and screws.

**Electrodes and Other Connections**

1. Prepare the RDO optical dissolved oxygen probe or polarographic dissolved oxygen probe and any other applicable electrodes according to the directions in the probe user guide.
2. Connect the appropriate items as labeled on the meter and as shown in the figure below:

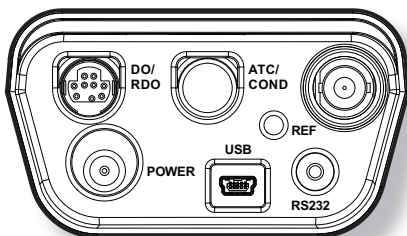

For additional information on meter setup and operation, refer to the reference guide. The reference guide is on the included CD and available at www.thermoscientific.com/water.

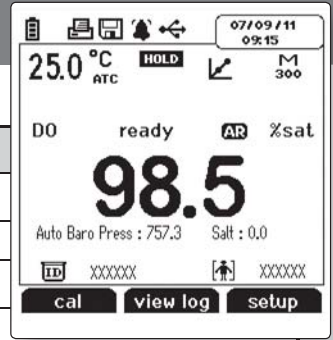

Display Information

Display Icon	Description
	Shown when the meter is running on AC power.
	Shown when the meter has batteries installed.
	Indicates data is being sent to a computer or printer.
	Indicates data is being sent to the data log.
	Shown when an alarm is set and the alarm value is reached.
	Indicates the meter is set to be interfaced with a printer or computer via the RS232 port.
	Indicates the meter is set to be interfaced with a printer or computer via the USB port.
	Displays the time and date entered in the setup menu.
	Displays the current temperature based on the temperature probe reading or entered temperature value. Shows the origin of the temperature as MAN (entered temperature) or ATC (temperature probe).
	Shown when is pressed and the displayed measurement is frozen.
	Indicates a calibration was successfully completed.
	Indicates a method is in use and the number of the method being used.
	Indicates the type of measurement as DO (polarographic probe) or RDO (RDO optical probe).
	Specifies the stability of the electrode as stabilizing or ready .
	Shown when the meter is in AUTO-READ mode. The AR icon will blink while the reading is stabilizing and stop blinking when the reading is stable and the measurement is locked on the display.
	Displays the measurement value based on the last saved calibration and current electrode reading. Units are shown to the right of the value.
	Shows the barometric pressure measured by the meter (Auto) or entered by operator (Man.) and used to correct dissolved oxygen measurements.
	Displays the salinity correction factor used to correct dissolved oxygen measurements.
	Shows the operator assigned sample ID number. <i>Star A323 meter only.</i>
	Shows the operator assigned user ID number. <i>Star A323 meter only.</i>
	Displays the action that will be performed when f1 is pressed.
	Displays the action that will be performed when f2 is pressed.
	Displays the action that will be performed when f3 is pressed.

Keypad Display Information



Press the f1, f2 and f3 function keys to perform the action shown above each key on the display.



Press to turn the meter on.

When the meter is on, press and quickly release to turn the display backlight on or off or hold down to turn the meter off.



In the measurement mode, press to take a measurement.

In the setup, calibration and other menus, press to escape the current menu and return to the measurement mode.



In the measurement mode, press to enter the setup menu.

In the setup, calibration and other menus, press to scroll up through a list of options.



In the continuous measurement mode, press to freeze the displayed measurement and press again to unfreeze the measurement.

In the setup, calibration and other menus, press to scroll left through a list of options.



In the measurement mode, press to change the displayed measurement mode. Options are %sat (DO as percent saturation), mg/L (DO as milligrams per liter) and °C (probe membrane temperature).









In the setup, calibration and other menus, press to scroll right through a list of options.



In the measurement mode, press to log or print a measurement.

In the setup, calibration and other menus, press to scroll down through a list of options.

Keypad



1. Press  to power the meter on. When the meter is on, press and quickly release  to turn the backlight on or off or press and hold  for about three seconds to power the meter off.
2. Press  to exit any meter function and return to the measurement mode.
3. The **f1**, **f2**, and **f3** function keys perform a variety of meter operations. The menu-specific operation is shown above each key. For example, press **f1** in the measurement mode to start a calibration.
4. The , ,  or  keys are used as navigation keys (up, right, down, left) when selecting from a fixed list or grid of meter options. In the measurement mode, these keys are used to access the setup menu, change the measurement mode, manually log or print a measurement and hold (freeze) a displayed measurement.

RDO/DO Calibration

Polarographic DO probes only - A polarographic DO probe must be polarized. The probe is continuously polarized when it is connected to the meter. If the probe is not connected to the meter: connect the probe to the meter, connect the meter to a power source and wait 30 to 60 minutes for polarization.



The Orion Star A223 and Star A323 RDO/DO meters can perform a calibration using water-saturated air (*Air*), air-saturated water (*Water*), Winkler titration (*Manual*) or zero point calibration (*Set Zero*). See the reference guide for detailed instructions for each calibration.

Air Calibration



1. In the measurement mode, press **f1 (cal)**.
2. Press  or  to highlight *Air* and press **f3 (select)**.
3. Rinse the RDO optical DO probe or polarographic DO probe with distilled water, blot dry with a lint-free tissue and place into the prepared calibration sleeve or BOD bottle. Allow the probe and water-saturated air to reach equilibrium.
4. When the probe and water-saturated air are ready, press **f3 (start)**.
5. Wait for the dissolved oxygen reading on the meter to stabilize and stop flashing. Once the reading is stable, the meter will display *Accepting Auto % Sat. Calibration* and **100.0 %** if using an RDO optical DO probe or **102.3 %** if using a polarographic DO probe.
6. Press **f3 (cal done)** to export the data to the calibration log or press **f2 (print)** to export the data to the calibration log and a printer or computer. The meter will proceed to the measurement mode.



Set Zero Calibration

A zero point calibration is performed in an oxygen-free solution. A zero point calibration is not generally required unless measurements will be taken below 10% saturation or 1 mg/L. Perform an air or water calibration before performing a zero point calibration.

1. In the measurement mode, press **f1 (cal)**.
2. Press  or  to highlight *Set Zero* and press **f3 (select)**.
3. Rinse the RDO optical DO probe or polarographic DO probe and any other electrodes in use with distilled water, blot dry with a lint-free tissue and place into the prepared zero oxygen standard. Allow the probe and standard to reach equilibrium.
4. When the probe and zero oxygen standard are ready, press **f3 (start)**.
5. Wait for the dissolved oxygen reading on the meter to stabilize and stop flashing. Once the reading is stable, the meter will display *Accepting Auto % Sat. Calibration* and **0.00**.
6. Press **f3 (cal done)** to export the data to the calibration log or press **f2 (print)** to export the data to the calibration log and a printer or computer. The meter will proceed to the measurement mode.















Measurement

Press  while taking a measurement in the continuous measurement mode to freeze the display and press  a second time to unfreeze the display and continue the measurement. Press  while taking a measurement to manually export the measurement to the data log, if the data log is enabled in the setup menu.

1. Rinse the RDO optical dissolved oxygen probe or polarographic dissolved oxygen probe and any other electrodes in use with distilled water, blot dry with a lint-free tissue and place into the sample.
2. Start the measurement and wait for it to stabilize.
 - a. If the meter is in **AUTO-READ** mode (default setting), press  to start the measurement. When the **AR** icon stops flashing, record the dissolved oxygen and temperature of the sample. Press  again to start a new measurement.
 - b. If the meter is in continuous mode, the meter will immediately start taking a measurement and update the display whenever the measurement changes. Wait for the display to show **ready** and record the dissolved oxygen and temperature of the sample.
 - c. *Star A323 meter only* – If the meter is in timed mode, the meter will log measurements at the preselected time interval, regardless of the measurement stability. The meter will update the display whenever the measurement changes, so the dissolved oxygen and temperature of the sample can be recorded when the display shows **ready**.
3. Remove the probe from the sample, rinse with distilled water, blot dry and place into the next sample.
4. Repeat steps 2 and 3 for all samples.
5. When all samples have been measured, store the probe according to its user guide.

Setup Menu

Navigating the Setup Menu













1. In the measurement mode, press  to enter the main setup menu.
2. Press , ,  or  to scroll through the main setup menu options. Press **f3 (select)** to select a main setup menu option.
3. Press  or  to scroll through setup submenu options. Press **f3 (select)** to select a setup submenu option.
4. Perform the appropriate actions to set the desired parameter in the setup submenus.
 - a. To select a value from a list of options, press  or  to highlight the desired value and press **f3 (select)** to set the value.
 - b. To enter a numeric value, use the numeric entry screen.
 - i. Select the value to be entered by pressing **f3 (select)** or **f3 (edit)**. The numeric entry screen will popup on the display.
 - ii. Press , ,  or  to highlight a number, decimal place or negative sign; press **f3 (enter)** to select the highlighted item and repeat until the desired value is shown on the top of the numeric entry screen.
 - iii. Press **f2 (done)** to save the value and exit the numeric entry screen.
5. Press **f1 (back)** and then  to return to the measurement mode at any time.

Setup Menu Overview













DO Channel	Settings	Log View	Diagnostics
<p>Method</p> <hr/> <p>Mode & Settings</p> <ul style="list-style-type: none"> • Measure Mode • Measure Unit • Resolution • Read Type • Baro Press • Salinity Correct • Stability • Averaging • Alarm Settings • Sample ID <small>*Star A323 meter only</small> <hr/> <p>Temperature</p> <hr/> <ul style="list-style-type: none"> • Manual Temp Value • Temperature Unit • Temperature Calibration 	<ul style="list-style-type: none"> • Export Data • Data Log • Date / Time • Language • Key Press Beep • Alarm Beep • Contrast • Auto Shut Off • User ID <small>*Star A323 meter only</small> 	<ul style="list-style-type: none"> • Data Log • Calibration Log 	<ul style="list-style-type: none"> • Meter Self Test • Factory Reset • About Meter

DO Probe Type Selection



















The Orion Star A223 and Star A323 RDO/DO meters accept and automatically recognize Orion RDO optical dissolved oxygen probes and Orion polarographic dissolved oxygen probes. If a different probe is used or the probe type needs to be verified, perform the following steps.

1. In the measurement mode, press .
2. Press , ,  or  to highlight **DO Channel** and press **f3 (select)**.
3. Press  or  to highlight **Mode and Settings** and press **f3 (select)**.
4. Press  or  to highlight **Measure Mode** and press **f3 (select)**.
5. Press  or  to highlight **DO** (polarographic probe) or **RDO** (RDO optical probe) and press **f3 (select)**.
6. Press  to return to the measurement mode.













Read Type Selection

1. In the measurement mode, press .
2. Press , ,  or  to highlight **DO Channel** and press **f3 (select)**.
3. Press  or  to highlight **Mode and Settings** and press **f3 (select)**.
4. Press  or  to highlight **Read Type** and press **f3 (select)**.
5. Press  or  to highlight **Auto**, **Continuous** or **Timed** (*Star A323 meter only*) and press **f3 (select)**.
 - a. *Star A323 meter only* – If **Timed** is selected and the time interval needs to be changed – highlight **Timed**; press  to highlight hours (HH), minutes (MM) or seconds (SS); press **f3 (edit)** to access the numeric entry screen; use the numeric entry screen to change the values and press **f1 (back)** when the time interval is correct.
6. Press  to return to the measurement mode.

Viewing the Calibration Log

1. In the measurement mode, press .
2. Press , , , or  to highlight **View Log** and press **f3 (select)**.
3. Press , , or  to highlight **Calibration Log** and press **f2 (accept)**.
4. Press , , or  to highlight **DO Channel** and press **f2 (select)**.
5. Press , , or  to highlight **DO** or **RDO** as the calibration type and press **f2 (select)**.
6. The meter will display a list of calibrations for the selected channel and calibration type. The list shows the sequential number of the calibration and the date and time it was saved (**07/01/2011 12:45**).
7. To view the calibration data, press , , or  to highlight a specific calibration and press **f2 (select)**. Press **f2 (print)** to print the calibration or press **f1 (back)** to return to the list of calibrations.
8. Press  to return to the measurement mode.

Viewing the Data Log

1. In the measurement mode, press .
2. Press , , , or  to highlight **View Log** and press **f3 (select)**.
3. Press , , or  to highlight **Data Log** and press **(accept)**.
4. The meter will display a list of the data points. The list shows the sequential number of the data point and the date and time the data point was saved (**07/01/2011 12:45**).
5. To view the measurement information for an individual data point, press , , or  to highlight the data point and press **f2 (select)**. Press **f2 (print)** to print the data point or press **f1 (back)** to return to the list of data points.
6. Press  to return to the measurement mode.