



Installation and Operation Guide



Manual #69-4303-070 of Assembly #60-4304-036
Copyright © 2012. All rights reserved, Teledyne Isco
Revision J, February 2018

Foreword

This instruction manual is designed to help you gain a thorough understanding of the operation of the equipment. Teledyne Isco recommends that you read this manual completely before placing the equipment in service.

Although Teledyne Isco designs reliability into all equipment, there is always the possibility of a malfunction. This manual may help in diagnosing and repairing the malfunction.

If a problem persists, call or e-mail Teledyne Isco technical support for assistance. Simple difficulties can often be diagnosed over the phone. For faster service, please have your serial number ready.

If it is necessary to return the equipment to the factory for service, please follow the shipping instructions provided by technical support, including the use of the **Return Material Authorization (RMA)** specified. **Be sure to include a note describing the malfunction.** This will aid in the prompt repair and return of the equipment.

Teledyne Isco welcomes suggestions that would improve the information presented in this manual or enhance the operation of the equipment itself.

Teledyne Isco is continually improving its products and reserves the right to change product specifications, replacement parts, schematics, and instructions without notice.

Contact Information

Customer Service

Phone: (800) 228-4373 (USA, Canada, Mexico)
(402) 464-0231 (Outside North America)
Fax: (402) 465-3022
Email: IscoCSR@teledyne.com

Technical Support

Phone: Toll Free (800) 775-2965 (Syringe Pumps and Liquid Chromatography)
Email: IscoService@teledyne.com
Return equipment to: 4700 Superior Street, Lincoln, NE 68504-1398

Other Correspondence

Mail to: P.O. Box 82531, Lincoln, NE 68501-2531
Email: IscoInfo@teledyne.com

General Warnings

Before installing, operating, or maintaining this equipment, it is imperative that all hazards and preventive measures are fully understood. While specific hazards may vary according to location and application, take heed of the following general warnings:

WARNING

Avoid hazardous practices! If you use this instrument in any way not specified in this manual, the protection provided by the instrument may be impaired.

AVERTISSEMENT

Éviter les usages périlleux! Si vous utilisez cet instrument d'une manière autre que celles qui sont spécifiées dans ce manuel, la protection fournie de l'instrument peut être affaiblie; cela augmentera votre risque de blessure.

Hazard Severity Levels

This manual applies *Hazard Severity Levels* to the safety alerts, These three levels are described in the sample alerts below.

CAUTION

Cautions identify a potential hazard, which if not avoided, may result in minor or moderate injury. This category can also warn you of unsafe practices, or conditions that may cause property damage.

WARNING









Warnings identify a potentially hazardous condition, which if not avoided, could result in death or serious injury.

DANGER

DANGER – limited to the most extreme situations to identify an imminent hazard, which if not avoided, will result in death or serious injury.

Hazard Symbols

The equipment and this manual use symbols used to warn of hazards. The symbols are explained below.

Hazard Symbols	
Warnings and Cautions	
	The exclamation point within the triangle is a warning sign alerting you of important instructions in the instrument's technical reference manual.
	The lightning flash and arrowhead within the triangle is a warning sign alerting you of "dangerous voltage" inside the product.
Symboles de sécurité	
	Ce symbole signale l'existence d'instructions importantes relatives au produit dans ce manuel.
	Ce symbole signale la présence d'un danger d'électocution.
Warnungen und Vorsichtshinweise	
	Das Ausrufezeichen in Dreieck ist ein Warnzeichen, das Sie darauf aufmerksam macht, daß wichtige Anleitungen zu diesem Handbuch gehören.
	Der gepfeilte Blitz im Dreieck ist ein Warnzeichen, das Sei vor "gefährlichen Spannungen" im Inneren des Produkts warnt.
Advertencias y Precauciones	
	Esta señal le advierte sobre la importancia de las instrucciones del manual que acompañan a este producto.
	Esta señal alerta sobre la presencia de alto voltaje en el interior del producto.

Signature™ Flow Meter

Table of Contents

Section 1 Introduction

1.1 Quick Start	1-2
1.2 Data Integrity	1-3
1.3 Security	1-3
1.4 Compatible Equipment	1-3
1.5 Identifying Signature Components	1-5
1.6 Controls and Indicators	1-6
1.6.1 Keypad	1-6
1.6.2 Display and LED	1-7
1.6.3 Backlight and Screen	1-7
1.6.4 Display Contrast	1-7
1.7 Technical Specifications	1-7

Section 2 Setup and Programming

2.1 User Interface	2-1
2.1.1 Keypad Functions	2-1
2.1.2 Connecting to the Signature with Flowlink	2-2
2.2 The Home Screen	2-7
2.3 Shortcuts	2-7
2.3.1 Adjust Level	2-7
2.3.2 Adjust Velocity	2-7
2.3.3 Purge	2-7
2.3.4 Histogram	2-7
2.3.5 Real-Time Measurement	2-8
2.3.6 Report View	2-8
2.4 Programming	2-8
2.4.1 Off-Screen Content	2-8
2.4.2 Character Grid	2-8
2.4.3 Pull Down Menus	2-9
2.5 Program Steps (Menu Trees)	2-10
2.6 Hardware Setup	2-11
2.6.1 Smart Sensor Setup (TIENet)	2-12
2.6.2 SDI-12 Setup	2-14
2.6.3 Modbus Input Setup	2-14
2.6.4 Modbus Output Setup	2-18
2.6.5 Modem Setup	2-18
2.7 Configure Options	2-20
2.7.1 Site Setup	2-21
2.7.2 Measurement Setup	2-21
2.7.3 Adjust	2-25
2.7.4 Equation/Trigger Setup	2-25
2.7.5 Data Storage/Push Setup	2-27
2.7.6 Sampler Setup	2-27
2.7.7 Inputs/Outputs/Alarms Setup	2-27
2.7.8 Reset Totalizers	2-30

2.7.9 Reports/History Setup	2-30
2.8 Administration	2-30
2.8.1 Language Options	2-31
2.8.2 Set New Passcode	2-31
2.8.3 Update Firmware	2-31
2.8.4 Sensor Diagnostics	2-31
2.8.5 Display Signature Information	2-32
2.8.6 Display License Information	2-32
2.8.7 Gather Fault Data	2-32
2.8.8 Restore to Factory Defaults	2-32
2.8.9 Home	2-32
2.9 USB Options	2-32
2.9.1 Retrieve Text Reports	2-33
2.9.2 Retrieve Data	2-34
2.9.3 Update Firmware	2-34
2.9.4 Save Current Program	2-34
2.9.5 Load Existing Program	2-34
2.9.6 Save Signature Information	2-34
2.9.7 Gather Fault Data	2-34
2.9.8 None of the above	2-34
2.10 Signature Data in Flowlink	2-35
2.10.1 Event Viewer	2-35
2.11 Verifying Exported Reports	2-36

Section 3 Standard Installation

3.1 Introduction	3-1
3.2 Connecting External Devices	3-1
3.3 Case Bottom Cable Entries	3-4
3.3.1 Cable Fittings	3-5
3.3.2 Connecting TIENet Devices	3-7
3.4 Power	3-11
3.4.1 Hard Wiring	3-11
3.4.2 Line Cord	3-11
3.4.3 Power Connections	3-11
3.5 Mounting the Signature	3-12
3.6 Outdoor Recommendations	3-13
3.7 Setting the Level	3-14
3.8 TIENet Sensor Installation in a Hazardous Location	3-14

Section 4 Portable Installation

4.1 Introduction	4-1
4.2 Portable Stand	4-1
4.2.1 Adjust Signature to Upward Position	4-2
4.3 Power	4-4
4.3.1 Power Connections	4-4
4.3.2 Outdoor Recommendations	4-4
4.3.3 Battery Installation	4-5
4.4 Battery Life Expectancy	4-6
4.4.1 Major Standard Equipment Settings Effecting Battery Life	4-6
4.4.2 Major Optional Equipment Settings Effecting battery Life	4-7
4.4.3 Additional Considerations for Battery Life	4-8
4.4.4 Calculating Average Current Draw	4-10
4.4.5 Battery Life Calculations	4-11
4.4.6 Low Battery Cut Off and Battery Care	4-12
4.5 Connect to External Devices	4-13
4.5.1 Connecting Devices to the TIENet Receptacle	4-13

Section 5 Equipment Options

5.1 AC Power Cord Kit /AC Wiring (Applies to Permanent Installation Only)	5-2
5.2 Battery Backup (Applies to Permanent Installation Only)	5-4
5.3 Power Loss Alarm	5-7
5.4 Mechanical Totalizer	5-8
5.5 External Desiccator	5-11
5.6 TIENet® Devices	5-12
5.6.1 Ultrasonic Level Sensor	5-12
5.6.2 Bubbler Level Sensor	5-13
5.6.3 Laser Doppler Velocity Sensor	5-13
5.6.4 Continuous Wave Doppler Velocity Sensor	5-13
5.6.5 Sampler Interface	5-14
5.6.6 pH and Temperature Device	5-15
5.6.7 TIENet Expansion Box	5-15
5.6.8 Contact Output Card (TIENet 304)	5-16
5.6.9 Analog Input Card (TIENet 307)	5-21
5.6.10 Analog Output Card (TIENet 308)	5-25
5.7 Isco Flowlink Software	5-29
5.8 Ethernet Modem	5-29
5.8.1 Ethernet Modem Configuration	5-32
5.8.2 Network Firewall Settings	5-33
5.9 Cellular Modems	5-34
5.9.1 CDMA Modem	5-34
5.9.2 GSM Modem	5-35
5.9.3 LTE Modem	5-35
5.9.4 SIM Card	5-35
5.9.5 Installing the Cellular Modem	5-36
5.9.6 Cellular Modem Configuration	5-39

Section 6 Maintenance and Servicing

6.1 Maintenance	6-1
6.2 Cleaning	6-2
6.3 Firmware Updates	6-2
6.4 Accessing the Interior	6-4
6.5 Desiccant	6-5
6.5.1 Internal Desiccator	6-5
6.5.2 External Desiccator	6-6
6.6 Troubleshooting	6-8
6.6.1 Signature Flow Meter	6-8
6.6.2 TIENet 300 Connector Case	6-11
6.6.3 TIENet 301 pH/Temp	6-11
6.6.4 TEINet 304 Contact Output Card	6-12
6.6.5 TIENet 307 Analog Input Card	6-13
6.6.6 TIENet 306 Sampler Interface	6-14
6.6.7 TIENet 308 Analog Output	6-14
6.6.8 TIENet 310 USLS	6-15
6.6.9 Installation Procedure	6-17
6.7 Front Cover Replacement	6-20
6.8 System Reset	6-20
6.9 Service and Repair	6-21

Appendix A Replacement Parts

A.1 How to Order	A-1
----------------------------	-----

A.2 Signature Flow Meter A-2

Appendix B Options and Accessories

B.1 Ordering Information B-1
B.2 Signature Flow Meter Accessories B-1
B.3 Power Accessories B-2
B.4 TIENet Accessories B-3
 B.4.1 Internal to Signature B-3
 B.4.2 Sensor and Cabling B-3
 B.4.3 301 pH/Temperature Device with Signature Connection Ending in Unterminated Leads B-3
 B.4.4 301 pH/Temperature Device with Signature Connection Ending in TIENet Plug B-3
 B.4.5 306 Sampler Interface Cable with Signature Connection Ending in Unterminated Leads B-4
 B.4.6 306 Sampler Interface Cable with Signature Connection Ending in TIENet Plug B-4
 B.4.7 310 Ex Ultrasonic Level Sensor with Signature Connection Ending in Unterminated Leads B-4
 B.4.8 310 Ex Ultrasonic Level Sensor with Signature Connection Ending in TIENet Plug B-4
 B.4.9 350 Area Velocity Sensor with Signature Connection Ending in Unterminated Leads B-4
 B.4.10 350 Area Velocity sensor with Signature Connection Ending in TIENet Plug B-5
B.5 Modems B-5
B.6 Manuals B-5
B.7 Sensor Mounting Rings B-5
 B.7.1 Spring Rings B-5
 B.7.2 Scissor Rings B-5

Appendix C Modbus Output Protocol

C.1 Introduction C-1
C.2 Operation C-1
C.3 Configurations C-2
C.4 Glossary of Terms C-3
C.5 Signature ASCII or RTU Address C-4
C.6 Register Definitions C-4
 C.6.1 Modbus Registers C-4

Appendix D Material Safety Data Sheets

List of Figures

1-1 Signature Flow Meter 1-1
1-2 Multiple options can be used in any combination 1-4
1-3 Front and exterior component identification 1-5
1-4 Home screen and basic keypad functions 1-6
1-5 Specification drawing: Signature Flow Meter, 1 of 2 1-10
1-6 Specification drawing: Signature Flow Meter, 2 of 2 1-11
1-7 1-13
2-1 Flowlink Connect screen 2-3
2-2 Site Info tab 2-4
2-3 Devices tab 2-5

2-4	Program tab: Accessing the browser	2-6
2-5	Home screen (normal operating mode)	2-7
2-6	Character grid	2-9
2-7	Menu Tree: Top menu	2-10
2-8	Menu Tree: Hardware Setup	2-11
2-9	Measurement parameters for each TIENet device	2-13
2-10	Modbus Input Setup	2-16
2-11	Editing Modbus device parameters	2-17
2-12	Modbus Output Setup	2-18
2-13	Menu Tree: Configure	2-20
2-14	Menu Tree: Flow rate input setup	2-23
2-15	Menu Tree: Volume Input Setup (total flow)	2-24
2-16	Menu for Rainfall Input Setup	2-24
2-17	Example of defining conditions & building equations.	2-26
2-18	Local alarm setup	2-28
2-19	SMS and Server alarm setup (modem required)	2-29
2-20	Menu Tree: Administration	2-30
2-21	Menu Tree: USB Options	2-33
2-22	Event Viewer in Flowlink	2-35
2-23	Report file verifier	2-36
3-1	Open door and front panel to access interior	3-2
3-2	Connector case, connectors, and fuses	3-3
3-3	Connector Case cable entries for power and external devices	3-4
3-4	Strain relief $\frac{3}{4}$ NPT Cord-grip fitting for TIENet devices	3-5
3-5	Cord-grip fittings installed	3-5
3-6	Diameter-seal plugs for unused ports	3-6
3-7	TIENet Device terminal strips	3-7
3-8	Installing TIENet cable with a cord-grip fitting	3-8
3-9	TIENet Device terminal connections	3-8
3-10	Attach wired terminal strip to connector case socket	3-9
3-11	Insert the cable reference tubing into the case board reference port	3-9
3-12	Position and secure the cable	3-10
3-13	Location of power supply	3-12
3-14	Signature Flow Meter mounted on wall	3-12
3-15	Weather shield - recommended for outdoor installations (Drawing & Photo courtesy of TRACOM, Inc.)	3-13
3-16	Level adjustment	3-14
3-17	Hazardous Location Installation Control Drawing-ATEX	3-15
4-1	Signature on portable stand side facing (left) and upward facing (right)	4-1
4-2	Pull out the handle latch pins on each side of the stand	4-2
4-3	One of the eight screws loosened.	4-2
4-4	Signature tilted up in preparation of removal	4-3
4-5	Signature in upward facing position	4-3
4-6	Connector E diagram	4-4
4-7	Notch in stand for the power cable	4-5
4-8	946 lead-acid battery installed under the Signature Portable	4-5
4-9	Battery hold down and thumb screw	4-6
4-10	Example of defining conditions and building equations	4-7
4-11	Measuring flow meter current	4-10
4-12	Connector case, connectors, and fuses for Signature Portable Flow Meter	4-13
4-13	How to connect a TIENet receptacle to the Signature Portable	4-14
4-14	Removing the plug	4-15
4-15	Connecting a rain gauge to the Signature receptacle (L) and then to the Signature connector board (R)	4-16
5-1	AC Line cord with a cord-grip fitting	5-2
5-2	Power supply mounting screw	5-2
5-3	Power supply removal/replacement	5-3
5-4	Power supply terminal strip: AC Input and DC Output	5-3
5-5	Battery backup kit contents	5-5

5-6	Attach extension cable to the connector case	5-6
5-7	Installing the battery backup mounting plate	5-6
5-8	Backup battery, installed	5-7
5-9	Remove totalizer window cover	5-9
5-10	Optional non-resettable totalizer installation	5-10
5-11	External desiccator, installed	5-11
5-12	Remove red caps before installing external desiccant cartridge	5-12
5-13	Removing the external desiccant cartridge	5-12
5-14	Tubing configuration for optimal drying power (Exterior desiccator required)	5-14
5-15	TIENet Expansion Box	5-16
5-16	304 contact output card front and back view	5-17
5-17	View of two cards installed	5-18
5-18	304 contact output device configuration	5-19
5-19	304 contact output setup	5-20
5-20	307 analog input channel identification and terminal connections	5-21
5-21	Direction of switch in active and passive modes	5-22
5-22	307 analog input device configuration	5-23
5-23	307 analog input setup	5-24
5-24	DO NOT connect to the ground connection	5-26
5-25	308 analog output channel identification and terminal connections	5-26
5-26	308 analog output device configuration	5-27
5-27	308 analog output setup	5-28
5-28	Ethernet modem kit contents	5-30
5-29	Ethernet modem installation	5-31
5-30	Ethernet modem setup: Communication settings (default settings shown)	5-32
5-31	Locating the NODE ID (MAC address) on the ethernet modem	5-33
5-32	LTE antenna-	5-34
5-33	CDMA Cellular modem	5-34
5-34	GSM Cellular modem-	5-35
5-35	Types of SIM cards	5-36
5-36	FCC ID label on modem and location of label on the bottom of Signature case	5-36
5-37	Cellular modem kit contents	5-37
5-38	Cellular modem installation	5-38
5-39	Cellular modem setup: Communication settings	5-39
6-1	Locating firmware updates	6-2
6-2	USB Micro adaptor cable (flash drive not included)	6-3
6-3	Open door and front panel to access interior	6-4
6-4	Removing the internal desiccant bag	6-5
6-5	External desiccator, installed	6-6
6-6	Desiccant indicating saturation	6-6
6-7	Removing the external desiccant cartridge	6-7
6-8	Opening the desiccant cartridge chambers	6-7
6-9	330 Bubbler assembly installation	6-17
6-10	Remove extra tubing and fitting (if applicable)	6-18
6-11	Routing and connections of 330 bubbler tubing	6-19
6-12	Front cover (door) replacement	6-20
C-1	Configuration example	C-2

List of Tables

1-1	Signature Flow Meter Technical Specifications	1-7
2-1	Modbus Setup Worksheet	2-15
4-1	Battery Life Expectancy (default measurement rate of 15 minutes)	4-8
4-2	Battery Life Expectancy (measurement rate of 5 minutes, all other parameters use default)	4-8

4-3	Default Method for Portable Signature	4-9
4-4	Additional Average Current Draw	4-9
5-1	Direction of arrows and mode types	5-22
6-1	Recommended Maintenance (Accessible Locations)	6-1
6-2	Recommended Maintenance (Difficult-to-Access Locations)	6-1
6-3	Troubleshooting: Signature Flow Meter	6-8
6-4	Troubleshooting: TIENet 300 Connector Case	6-11
6-5	Troubleshooting: TIENet 301 pH/Temperature Device	6-11
6-6	Troubleshooting: TIENet 304 Contact Output Card	6-12
6-7	Troubleshooting: TIENet 307 Analog Input Card	6-13
6-8	Troubleshooting: TIENet 306 Sampler Interface	6-14
6-9	Troubleshooting: TIENet 308 4-20mA Analog Output	6-14
6-10	Troubleshooting: TIENet 310 Ultrasonic Level Sensor	6-15
C-1	Modbus Output Registers for Signature Flow Meter	C-4

Signature® Flow Meter

Section 1 Introduction

The Signature Flow Meter is designed for open channel flow monitoring applications using any combination of flow and parameter measurement technologies and sampling, depending on what is required at the monitoring site.

The Signature has built-in standard level-to-flow conversions that cover the majority of open channel flow measurement situations. Flow measurement is usually a calculation based on a known relationship between liquid level and flow rate. Additionally, the Signature can calculate flow using standard open channel level-to-flow and area-velocity conversions, as well as equations, or data points, depending upon the measurement device(s) attached to the meter and the program specified by the user.

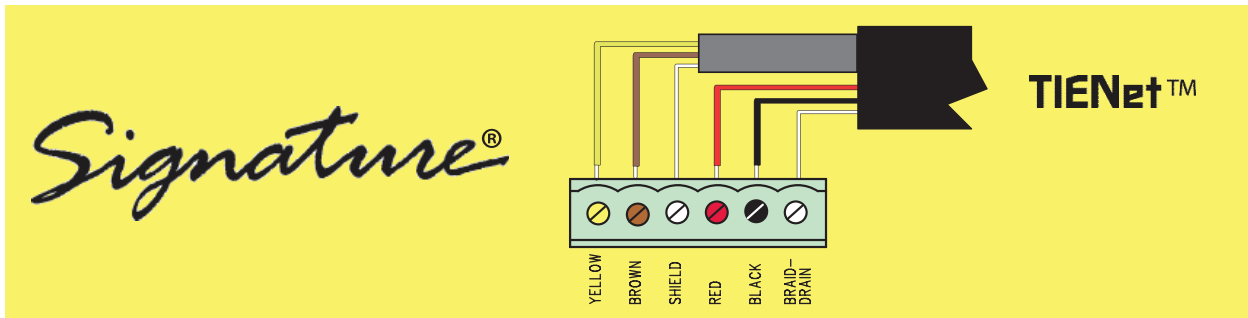
Note

Recent enhancements have been made to the Signature Flow Meter. Many of these features are standard for all new Signature units which are identifiable by the serial label mounted on the bottom of the unit (PN 60-4304-065).



Figure 1-1 Signature Flow Meter

1.1 Quick Start



Numerical: **0**, **1**, **2** ...

- Enter values • Type characters

Arrows: ,  ...

- Navigate up, down, left, right


Soft Keys:






- Current displayed function
- **Back** = Return to last menu
- **Next** = Confirm & advance to next step

Home: 


- Return to Home Screen from anywhere

Enter: 

- Open list • Confirm selection • Activate field
-  = Pull down list available
-  = Character grid available

Delete / Exit: 

- Clear last entry • Exit list • Close window

Decimal: 

- Navigate up one screen at a time

Plus-Minus: 

- Navigate down one screen at a time
- Adjust screen contrast, when used with the up or down arrow keys.

Hardware Setup
TIENet Devices
SDI-12 Setup
Modbus In
Modbus Out
Modem

Configure Options
Site: Clock, Name, Display, Units
Measurement Setup:
Level, Velocity, Flow, Volume
Adjust: Level, pH, Velocity
Equation / Trigger
Data Storage Rate / Data Push
Sampler Interface Setup
Outputs: Alarm, Analog
Reset Totalizers
Reports / History

Administration
Language
Set New Passcode
Update Firmware
Sensor Diagnostics
System Information
License Information
Gather Fault Data
Restore Defaults

1.2 Data Integrity

What makes the Signature Flow Meter unique is its ability to verify data integrity. This is accomplished by logging four special event data types that cannot be altered, and are designed to alert the user to any trends or anomalies, and to assess compliance. This data can be downloaded from the flow meter and observed in tabular or graphical format alongside regular site data, using Flowlink software (see Section 2.10 *Signature Data in Flowlink*).

The data can also be downloaded onto a flash drive via the micro-USB assembly on the front panel of the flow meter, then imported into a spreadsheet or other viewing application (refer to Section 2.9 *USB Options* for more information).

The four event data types are:

Program Report – Tracks changes to the Signature Flow Meter configuration

Summary Report – Documents summaries of data measurements (e.g., Min/Max/Avg)

Diagnostic Report – Tracks results from diagnostic tests

History Report – Tracks user and meter events (e.g., level adjustments, data push, etc.)

1.3 Security

The Signature Flow Meter can be secured shut with a padlock with the hasp on the right side of the housing (refer to Figure 1-3). The program settings and recorded data can be protected by a user-selected passcode (refer to Section 2.8.2 *Set New Passcode*).

1.4 Compatible Equipment

The Signature Flow Meter can interface with a variety of measurement devices and other system components, depending on site requirements.

Measurement devices for flow and water quality can be connected to the same Signature Flow Meter and run simultaneously with TIENet® connectivity (up to nine TIENet devices). The flow meter can also communicate with an optional Teledyne Isco wastewater sampler and rain gauges.

For descriptions of interfacing and parameter sensing TIENet devices, refer to Section 5 *Equipment Options*. Each external TIENet device comes with its own user manual.

The Signature is capable of receiving data from devices using Modbus ASCII or Modbus RTU protocol.

A variety of application-specific accessories are available from Teledyne Isco. Refer to Appendix B *Options and Accessories* for a complete list with ordering information.

A basic Signature system has one or more TIENet devices for flow and/or parameter measurement connected to the Signature Flow Meter (up to nine TIENet devices at once). Other configurations may include an enclosure and additional internal or external devices, including analog output cards, analog input cards, contact output cards, a modem, up to two SDI-12 inputs, and Modbus devices.

When connected remotely via modem, the web interface of the Signature Flow Meter provides remote control and data access.



Figure 1-2 Multiple options can be used in any combination

1.5 Identifying Signature Components

The following are key components of the Signature Flow Meter:

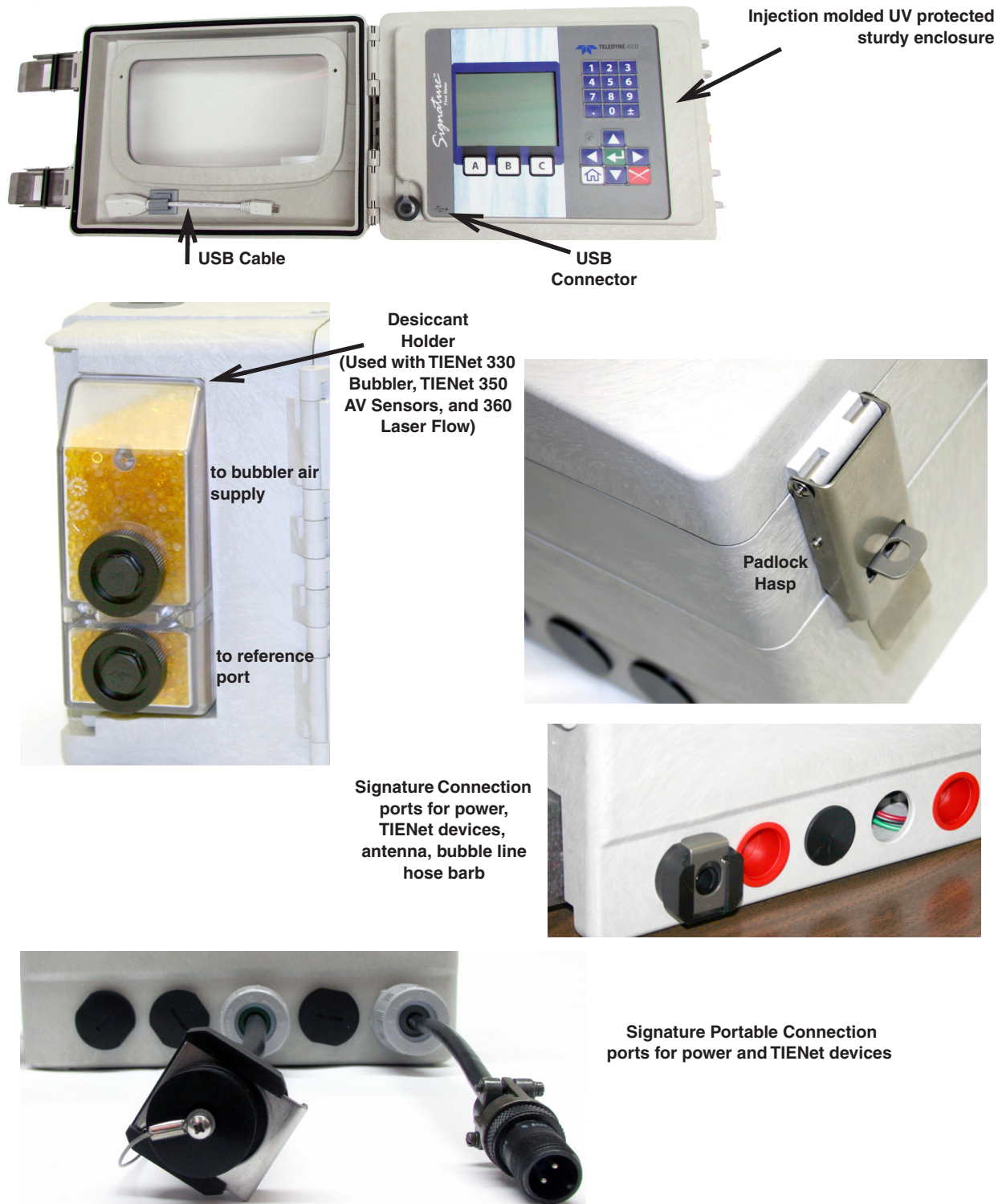


Figure 1-3 Front and exterior component identification

1.6 Controls and Indicators

Before programming and operating the Signature Flow Meter, become familiar with the keypad and standard screens.

1.6.1 Keypad

Keys are identified in Figure 1-4; keypad functions are detailed in Section 2.1.1.

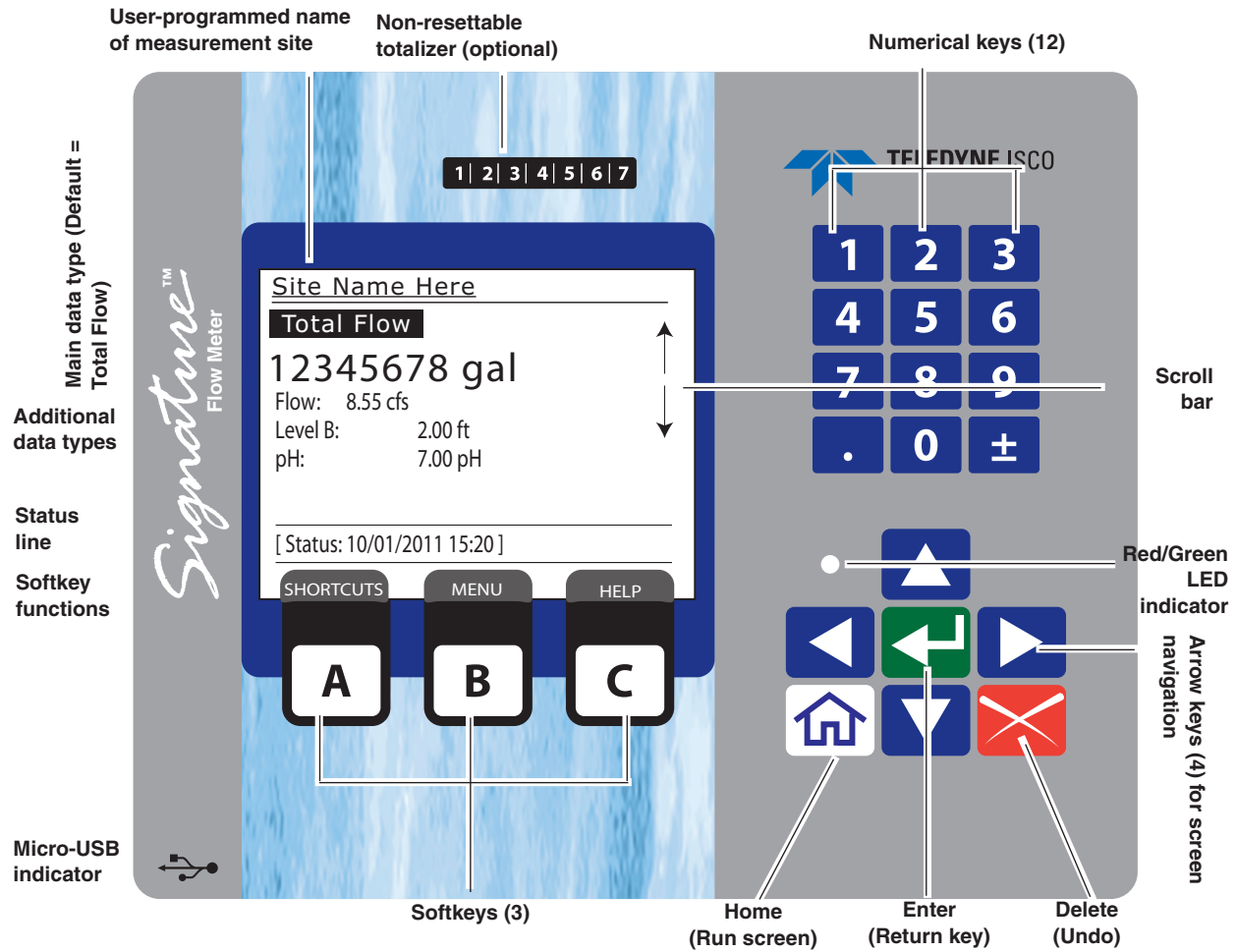


Figure 1-4 Home screen and basic keypad functions

Below the display are three software configured function keys (softkeys) that are used to make selections and navigate through menus. Their specific functions are dependent upon what operation you are performing, and will appear in the display window.

1.6.2 Display and LED

The LED on the front panel is aligned next to the Status line on the display screen.

- A green light indicates that new information is available for viewing in the Status line.
- A flashing green light indicates low power mode when the screen is off and data traffic on some channels.
- A red light indicates a warning or a user-defined alarm condition, with further details viewable by pressing the Alarm softkey (C).

Figure 1-4 shows the standard home screen, or run screen.




Displayed menus and programming steps are explained in Section 2 *Setup and Programming*.

1.6.3 Backlight and Screen

There is an option to turn off the backlight and screen.

1.6.4 Display Contrast

The contrast of the LCD screen can be adjusted using the keypad.

To adjust the contrast, hold down the ± key  and repeatedly press the down arrow  (softer) or the up arrow  (sharper) to achieve the desired appearance.

1.7 Technical Specifications

Table 1-1 provides technical specifications for the Signature Flow Meter.

Table 1-1 Signature Flow Meter Technical Specifications^a	
Size (HxWxD)	22.6 x 31.0 x 20.9 cm (8.9 x 12.2 x 8.2 in) with mounting bracket & external desiccator
Size with Portable Stand (HxWxD)	42.5 x 34.5 x 26.6 cm (16.74 x 13.58 x 10.48 in)
Weight	
Flow Meter, No Bubbler	Signature w/o options: 4.5 kg (10 lbs) Signature w/ all interior options: 4.9 kg (10.7 lbs) Signature w/ all int. options + mounted battery backup: 7.8 kg (17.3 lbs)
Bubbler Flow Meter	Signature w/o options: 5.9 kg (13 lbs) Signature w/ all interior options: 6.1 kg (13.5 lbs) Signature w/ all int. options + mounted battery backup: 9.1 kg (20 lbs)
Weight (Portable Signature)	Base Portable Signature w/ stand, TIENet Receptacle, DC Power Cable, Desiccator: 8.0 Kg (17.5 Lbs.) Optioned Portable Signature w/ Bubbler, stand, TIENet Receptacle, DC Power Cable, Desiccator, CDMA Modem, 3 option card, rain gauge: 10.1 Kg (22.3 lbs.) Includes antenna. Stand only: 3.9 Kg (8.7 lbs.)
Materials	
Housing	PPO Plastic (Noryl)
Window	Polycarbonate
Hardware	Stainless Steel

Table 1-1 Signature Flow Meter Technical Specifications^a (Continued)

Enclosure	NEMA4X/IP66
Power	100 to 240 VAC, 50/60Hz, 1.3A; Disconnect Device = Line Cord 12VDC (optional battery backup) ^b 12VDC 4.0A battery standalone power
External Power Connection	DC Power: 12 or 24VDC Solar, DIN Rail, etc 10 to 28.5 VDC nominal 4VDC minimum for disposable battery use 36VDC Maximum 4 amp Time Delay fuse
Connections to Signature Flow Meter	
External TIENet devices	Bottom Cable entry, 1 to 4 position (³ / ₄ " NPT user-supplied conduit or optional cord grips); Pluggable screw terminals, 6-position;
Power supply	Screw terminal, Wire 14-22 AWG
Parameter inputs	Fixed terminals, 3-pin, Wire 14-30 AWG
Analog Input	Pluggable screw terminal, 3-position, Wire 14-30 AWG
Analog Output	Pluggable screw terminal, 3-position, Wire 14-30 AWG
Contact Output	Pluggable screw terminal, 3-position, Wire 14-30 AWG
Cellular Modems	Antenna Custom SMB connector
Ethernet	RJ-45 connector
330 Bubbler module	Internal, factory-installed
Flow Measurement Technologies	Ultrasonic (TIENet 310) Bubbler (TIENet 330) Laser Doppler Velocity (TIENet 360 LaserFlow) Continuous Wave Doppler Velocity (TIENet 350)
Flow Conversions	Weir, Flume, British Flume, Metering Insert, Manning Formula, Equation, LTF or LTA Data Points (up to 50 pairs), Area Velocity
Data Storage	Non-volatile flash; retains stored data during program updates. Interval: 15 or 30 seconds; 1,2, 5,15, or 30 minutes; or 1, 2, 4, 12, or 24 hrs Capacity: 8M (180 days with 5 parameters logged at 1 minute intervals, reports at 24-hour intervals)
Setup and Data Retrieval	Serial connection to PC via USB; Cellular or Ethernet modem
Ambient Temperature Range (Operation and Storage)	-20 to 60 °C (-4 to 140 °F) ^c NOTE — The operating ambient temperature range of the optional mechanical totalizer (see Section 5.4) is -10 to 60 °C (14 to 140 °F).
Optional Teledyne Isco Sampler Interfacing	TIENet 306 device Output: Flow pacing, Enabling on trigger Input: Event and bottle information
Optional 304 TIENet Contact Output:	
Switching modes	Normally open, Normally closed
Max Load	30 volts 1 amp
Isolation	Galvanic Isolation
Outputs per card	2
Optional 307 TIENet Analog Input:	
Output voltage (in active mode)	Configurable either active (signature supplying loop power) or passive (relying on loop power, signature is not powering the loop).
Range	17 VDC minimum 4 to 20 mA
Isolation	Galvanic Isolation
Maximum Load	400Ω maximum (in passive mode at 20 mA)
Outputs per card	2

Table 1-1 Signature Flow Meter Technical Specifications^a (Continued)

Optional 308 TIENet Analog Output:	
Range	4 to 20 mA
Isolation	Monolithic Isolation
Maximum Load	900Ω
Outputs per card	2
Industry Standard Inputs	Two SDI-12, RS485 Modbus ASCII & RTU, 4-20 mA Analog
Industry Standard Outputs	4-20 mA Analog, Modbus ASCII & RTU
Rain Gauge Connection ^d	Fixed terminals, 3-pin, Wire 14-30 AWG
Communication Options	Direct USB Serial Connection, CDMA (1XRTT), GSM (GPRS), and Ethernet

- a. All specifications are subject to change without notice.
- b. Power loss alarm options are available. Refer to 5.3 *Power Loss Alarm* in Section 5 *Equipment Options*.
- c. Older model 69-4303-024 Connector Case circuit boards limit Ethernet ambient range to +40 °C (104 °F)
- d. Optional industry standard rain gauge connector 60-4304-055.

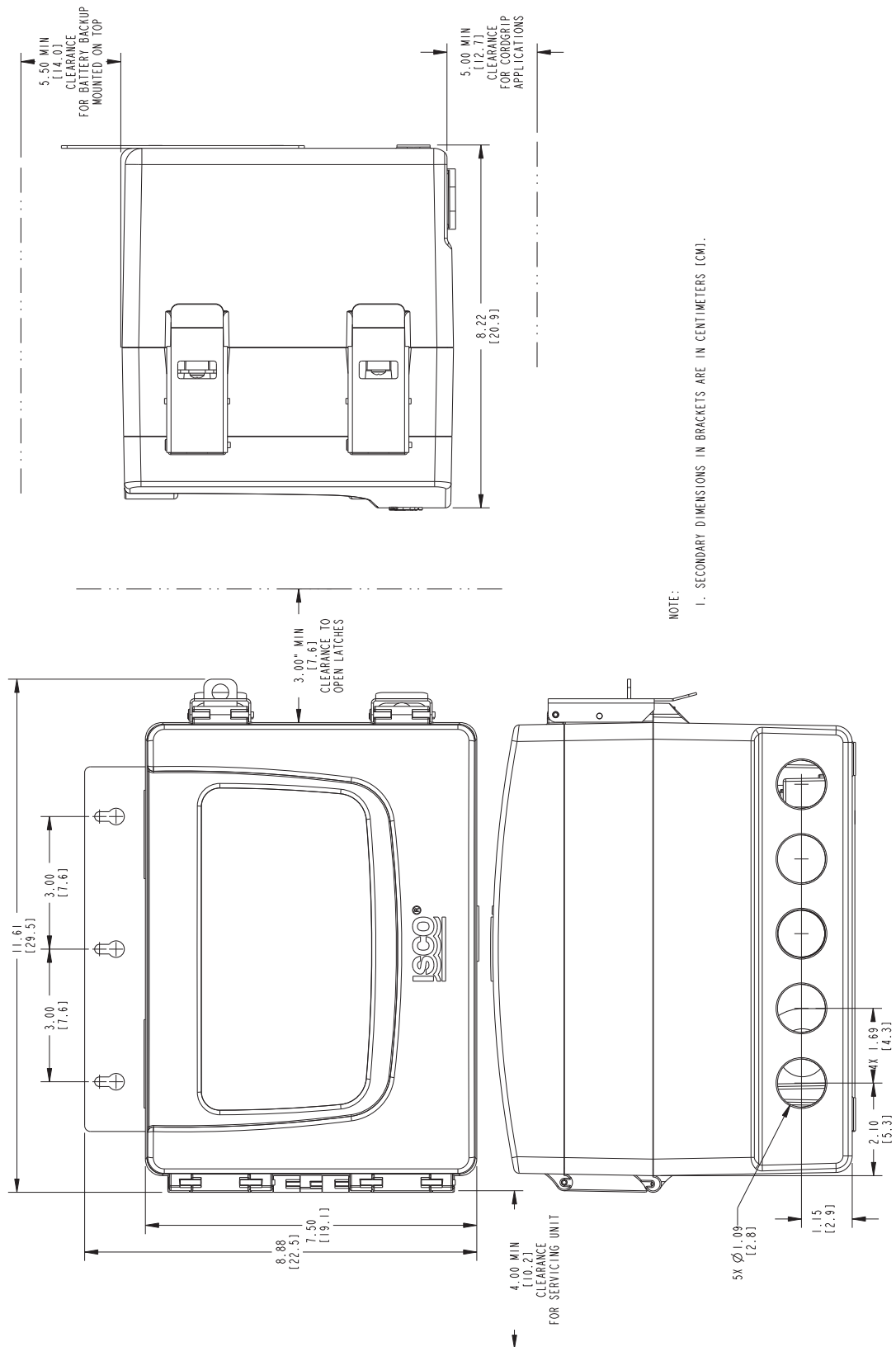


Figure 1-5 Specification drawing: Signature Flow Meter, 1 of 2

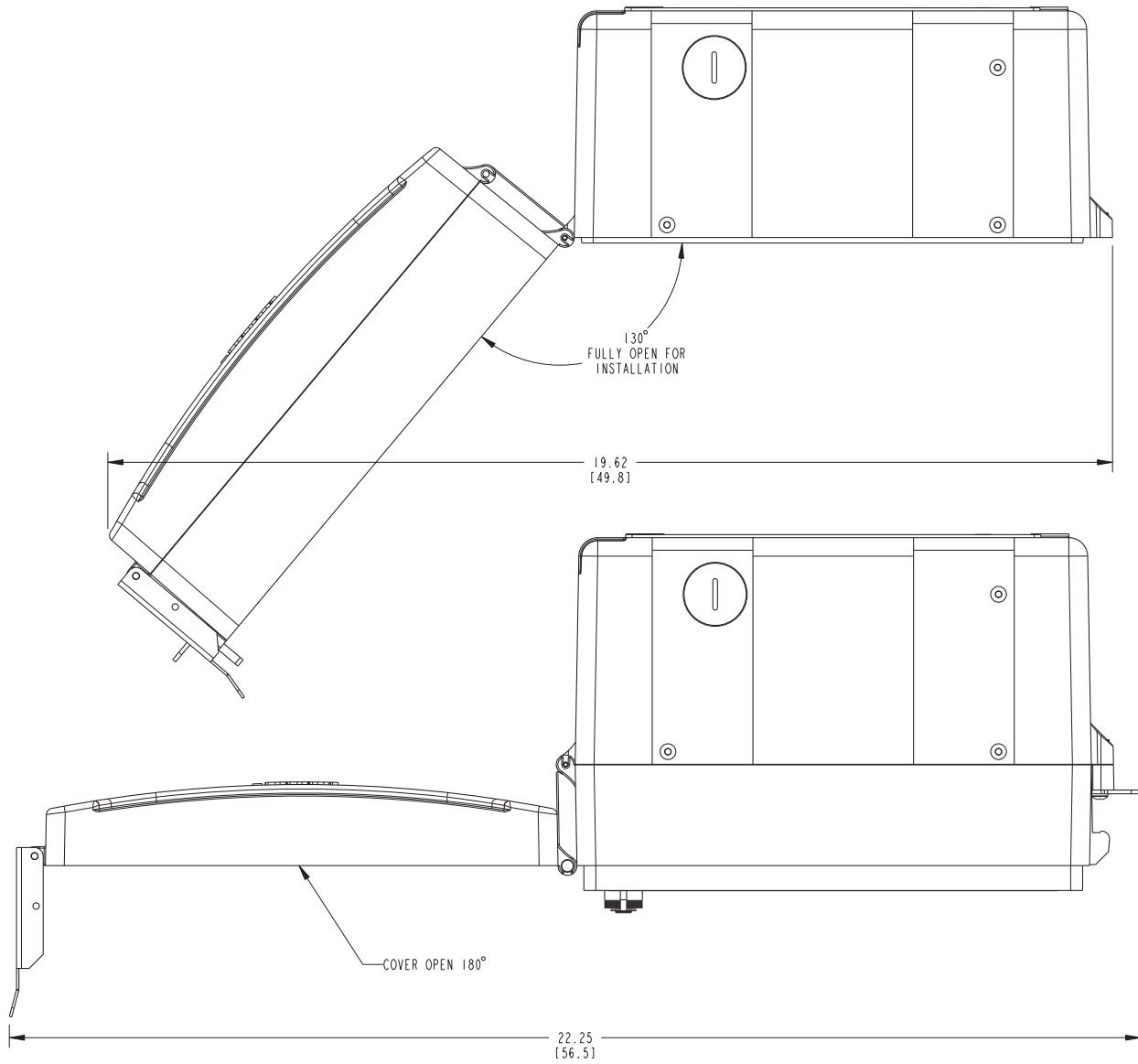
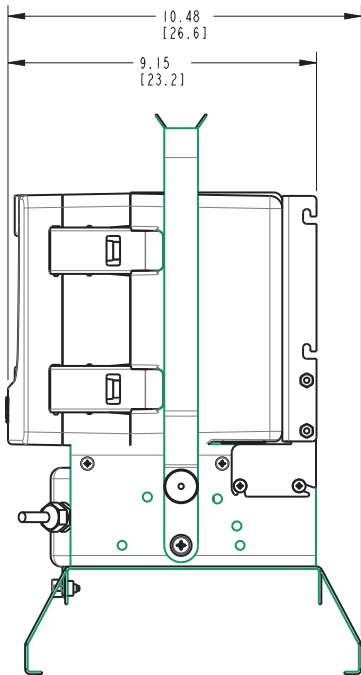
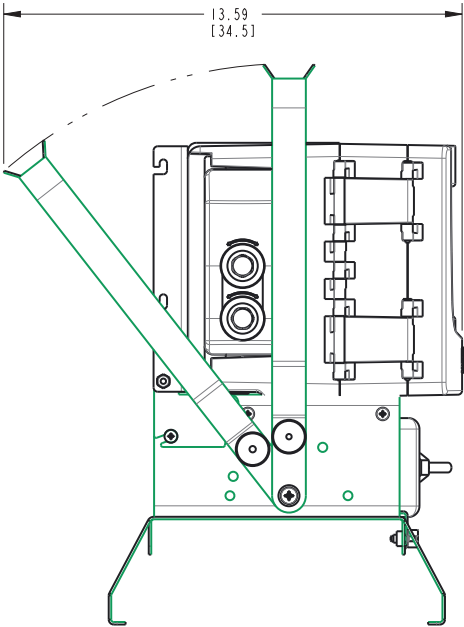
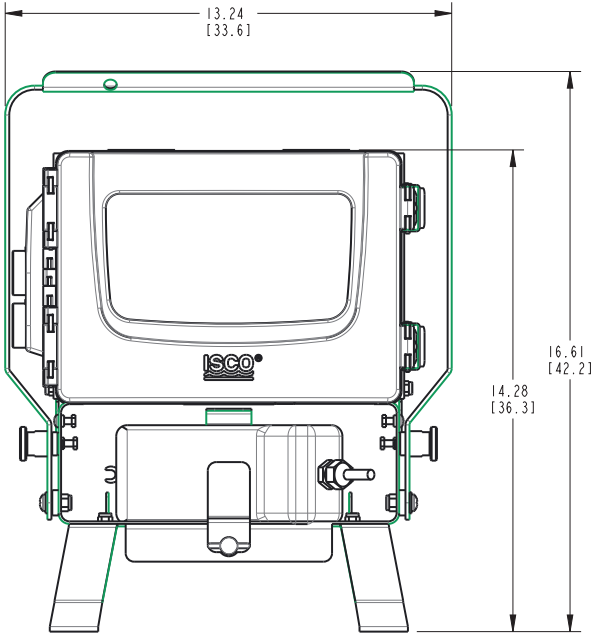
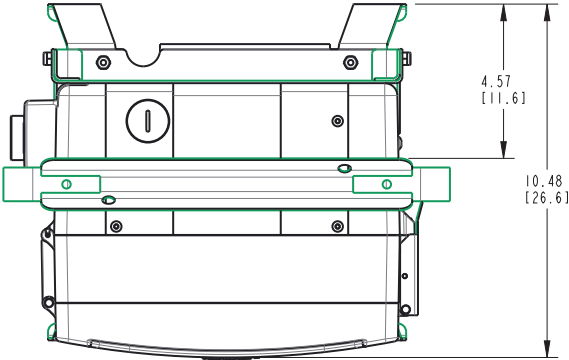


Figure 1-6 Specification drawing: Signature Flow Meter, 2 of 2

Signature® Flow Meter
Section 1 Introduction



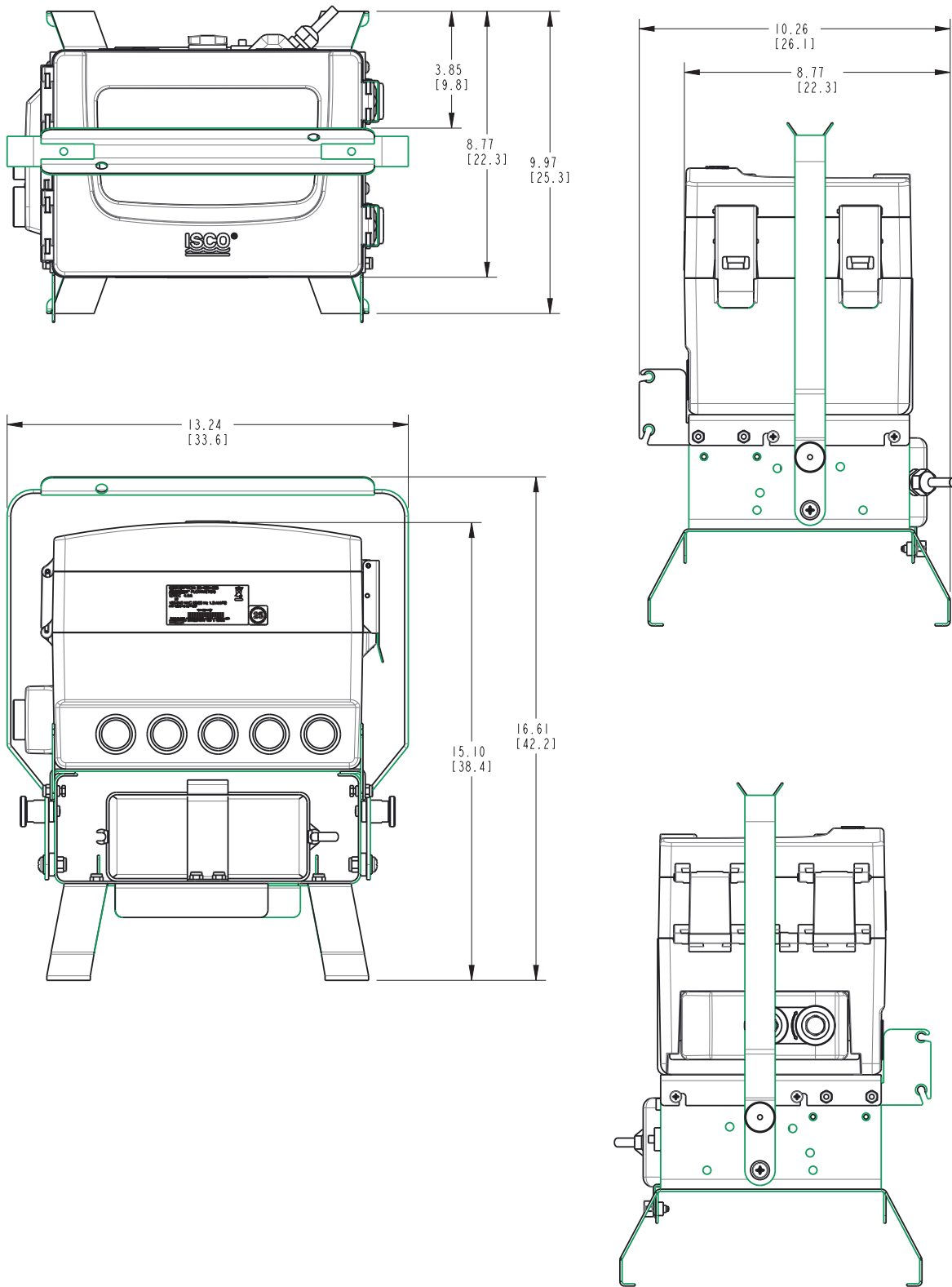


Figure 1-7

Signature® Flow Meter

Section 2 Setup and Programming

The Signature Flow Meter is shipped from the factory with a default program already configured. The Signature Portable is shipped with different defaults than the Signature. Your particular installation will normally require different program settings, specific to your monitoring site and application.

This section of the manual explains the Signature's operating modes, and provides instructions for site setup and programming. Programming may be performed before transportation to the installation site.


2.1 User Interface


The Signature Flow Meter can be set up, programmed, and interrogated directly through the keypad and display screen, or remotely using a computer equipped with Teledyne Isco's Flowlink® software, with either a USB cable or optional modem.


The Signature Flow Meter has its own browser, accessed via Flowlink, that mirrors the physical keypad and display.


2.1.1 Keypad Functions

The following briefly explains the basic function of each key.


 The numerical keys are for entering values during setup/programming.

 The large softkeys (A, B, and C) perform whatever function is currently displayed above them. Note that pressing the BACK softkey (A) will discard any changes you have made without saving.

 The arrow keys are for navigating to different areas on- and off-screen. The up/down arrows navigate a single line at a time.

 From the home screen, the Enter key is used to adjust or configure the currently highlighted parameter.

From programming screens, the Enter key confirms selections and entries you have made, opens the setup/programming screen for a highlighted parameter, displays the character grid for alphanumeric entry, displays a calendar for date selection, or displays the pull down menu for a highlighted field.

 **Note**
Enter is for selection only. The NEXT softkey is for selection and advancement to a subsequent step.



The home key returns the flow meter to the home screen from any other screen.



The delete key clears the last character entry, exits a pull down list, or closes an open window.



In addition to typing the decimal/period, this key can be used to navigate up one screen at a time.



The ± key can be used to navigate down one screen at a time, and also to adjust screen contrast, when used with the up/down arrow keys.

2.1.2 Connecting to the Signature with Flowlink

With Flowlink software version 5.15.XX or later, you can set up, program, and download data from the flow meter through its browser. Connection between the flow meter can be direct, through the micro-USB assembly on the front panel, or remote, with an internal cellular or ethernet modem.

USB Driver for Signature

In order for your computer to connect to the Signature flow meter through the micro-USB assembly, you must have the correct driver installed. USB drivers for both 32-bit and 64-bit operating systems are included with your flowlink program.

To install the driver:

After installing Flowlink, navigate to its program directory, and then to the USB Driver folder, typically at C:\Program Files\Flowlink 5.1\USB Driver.

Here you will find two drivers:

4300Driver_x64.msi for 64-bit operating systems and 4300Driver_x86.msi for 32-bit operating systems.

Without the Signature connected to your computer, begin running the appropriate file for your operating system. When prompted, connect the Signature to your computer's micro-USB assembly. You should see a message in the lower right corner stating that new hardware has been found at the appropriate com port number.

Ensure that the Signature flow meter is connected to the computer before launching Flowlink.

Connect window

You can connect with the Connect window, or if you have connected with this site before, highlight the Signature site file in the workspace (left column in Flowlink) and select Item > Connect.

In the Connect window, select the Type of connection.

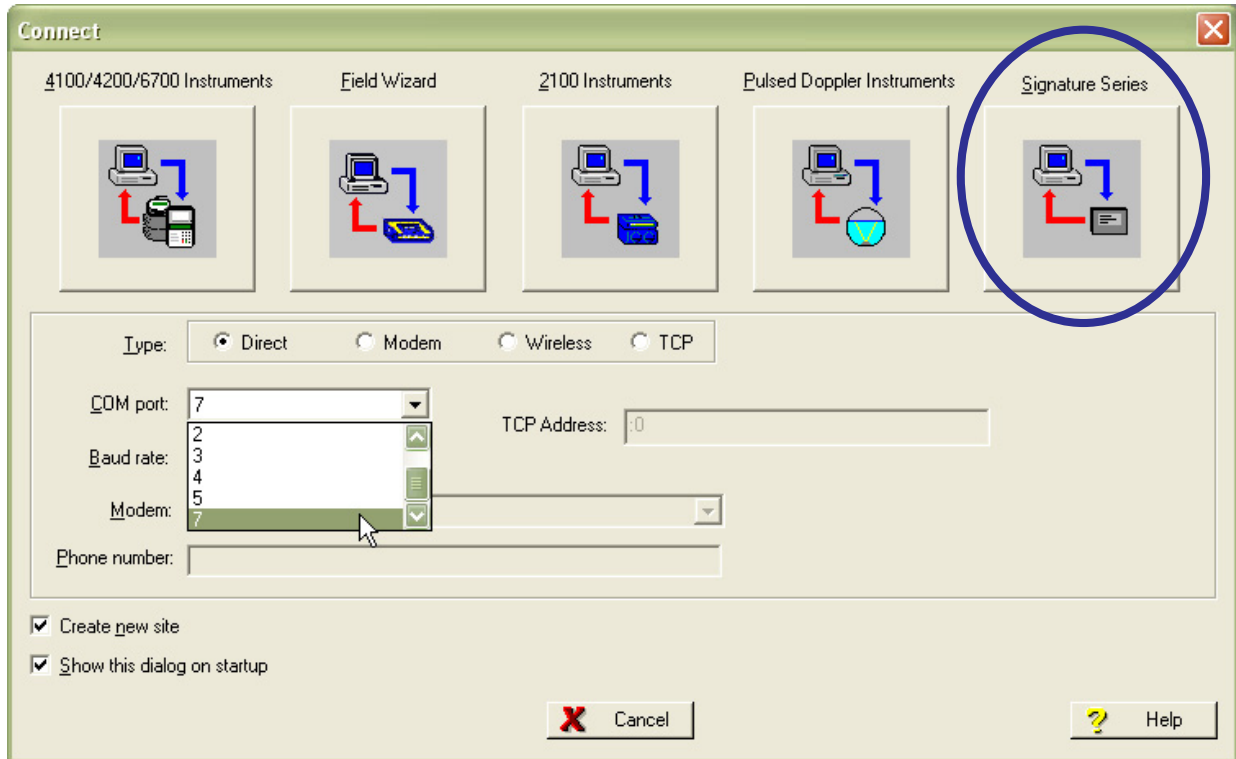


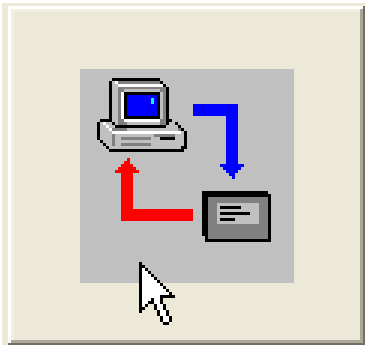
Figure 2-1 Flowlink Connect screen

Direct connection is made through the micro-USB assembly. From the COM Port pull down list, select the port associated with the Signature.

TCP connection is made from the computer to the Signature flow meter's optional CDMA, GSM, or Ethernet modem. Enter the correct static IP and port number, separated by a colon, the correct public domain address.

If you do not want the flow meter matched with an existing site in the database, select the Create new site check box. (If this is the first time the flow meter is connected to Flowlink, a new site will be created automatically.)

Then click the large button under the heading Signature Series.



Site Screen

The Signature site screen has three tabs:

Site Info contains information specific to this site. Enter all relevant information into the Site Info fields, including the desired Site Name, and save the information by clicking Apply.

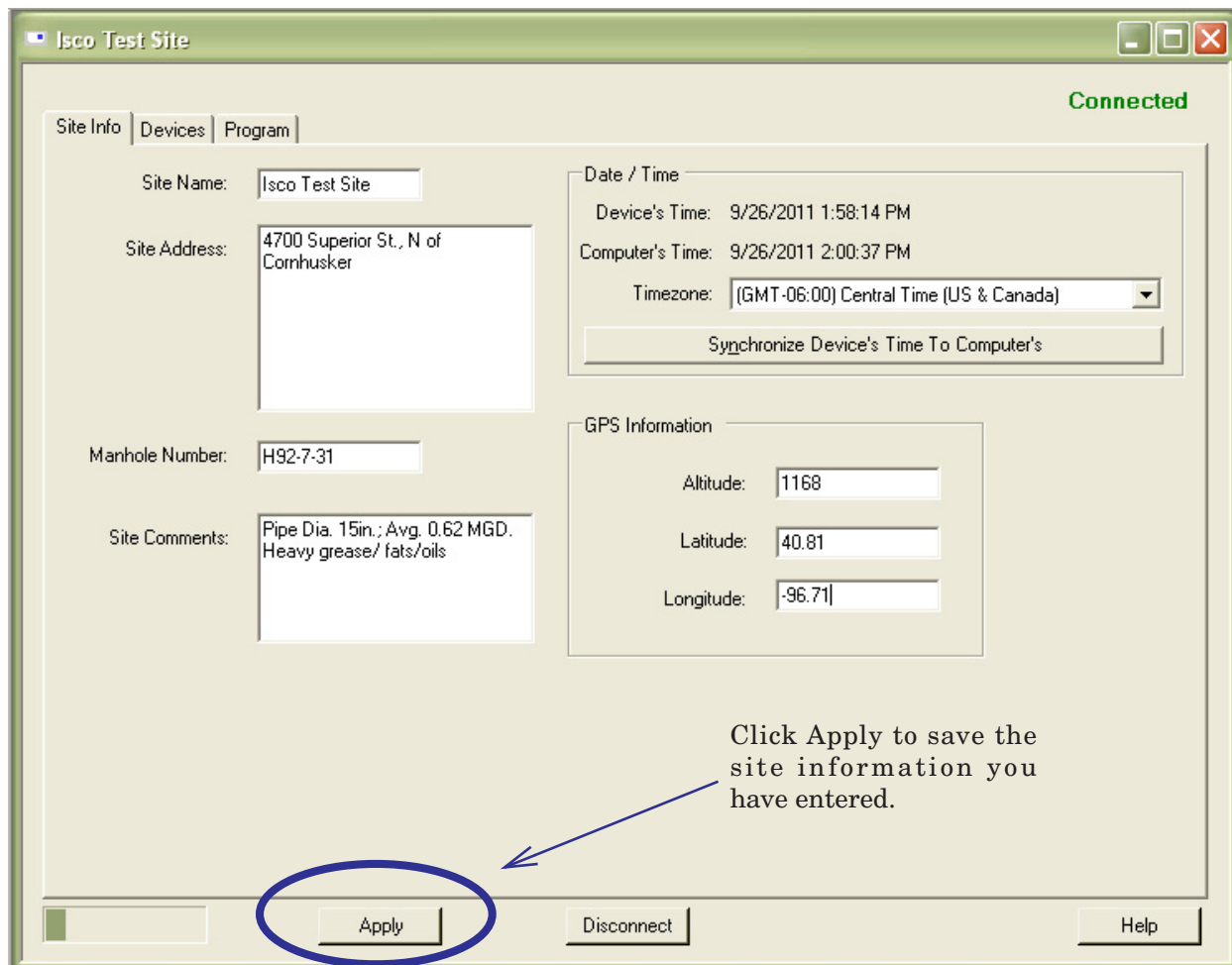


Figure 2-2 Site Info tab

Devices lists the name, software version, and hardware version of the flow meter for offline viewing of the site file.

This information, along with that of any connected TIENet devices, can be viewed from the specific flow meter's firmware (refer to *Sensor Diagnostics*, on page 2-31).

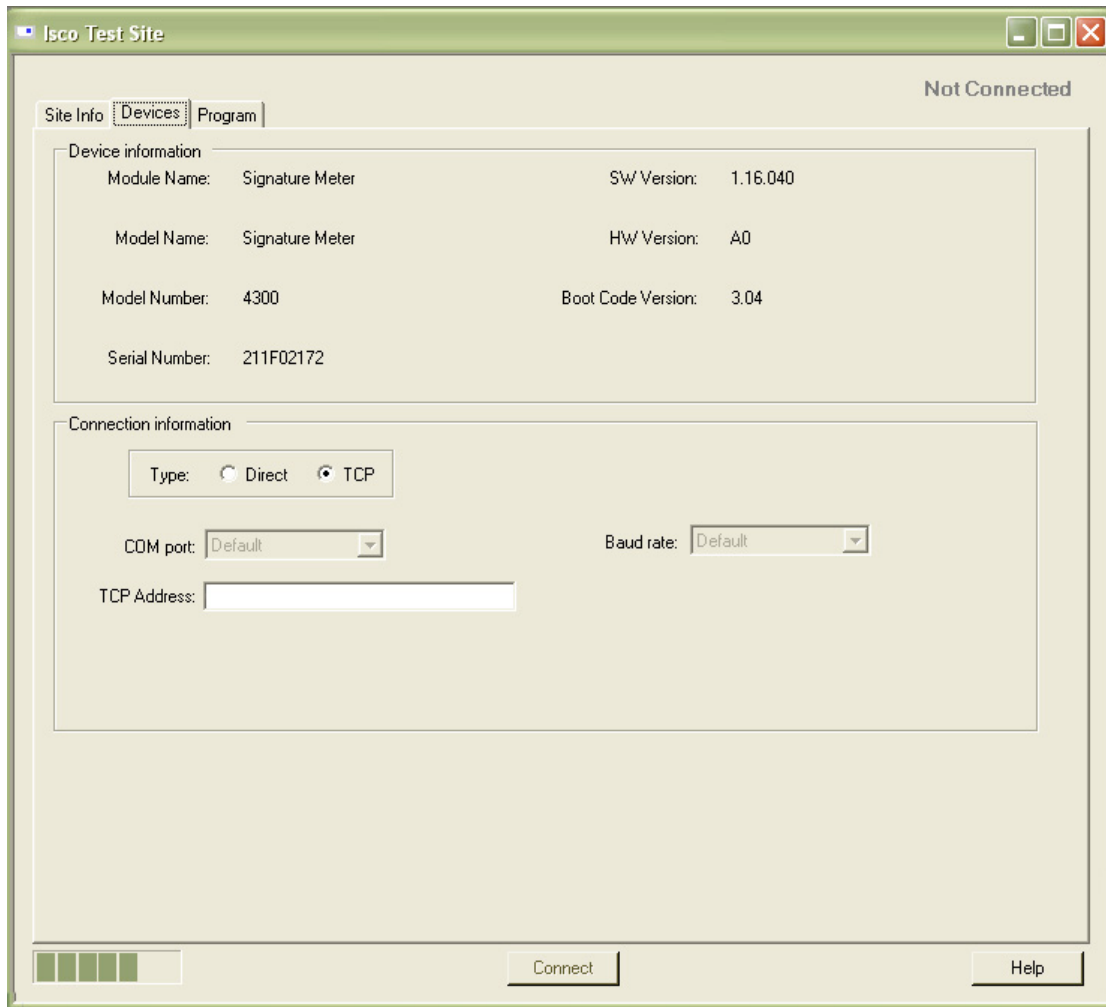
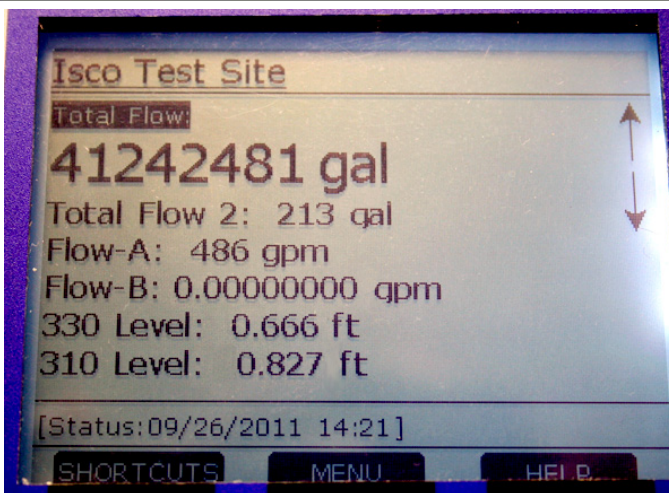
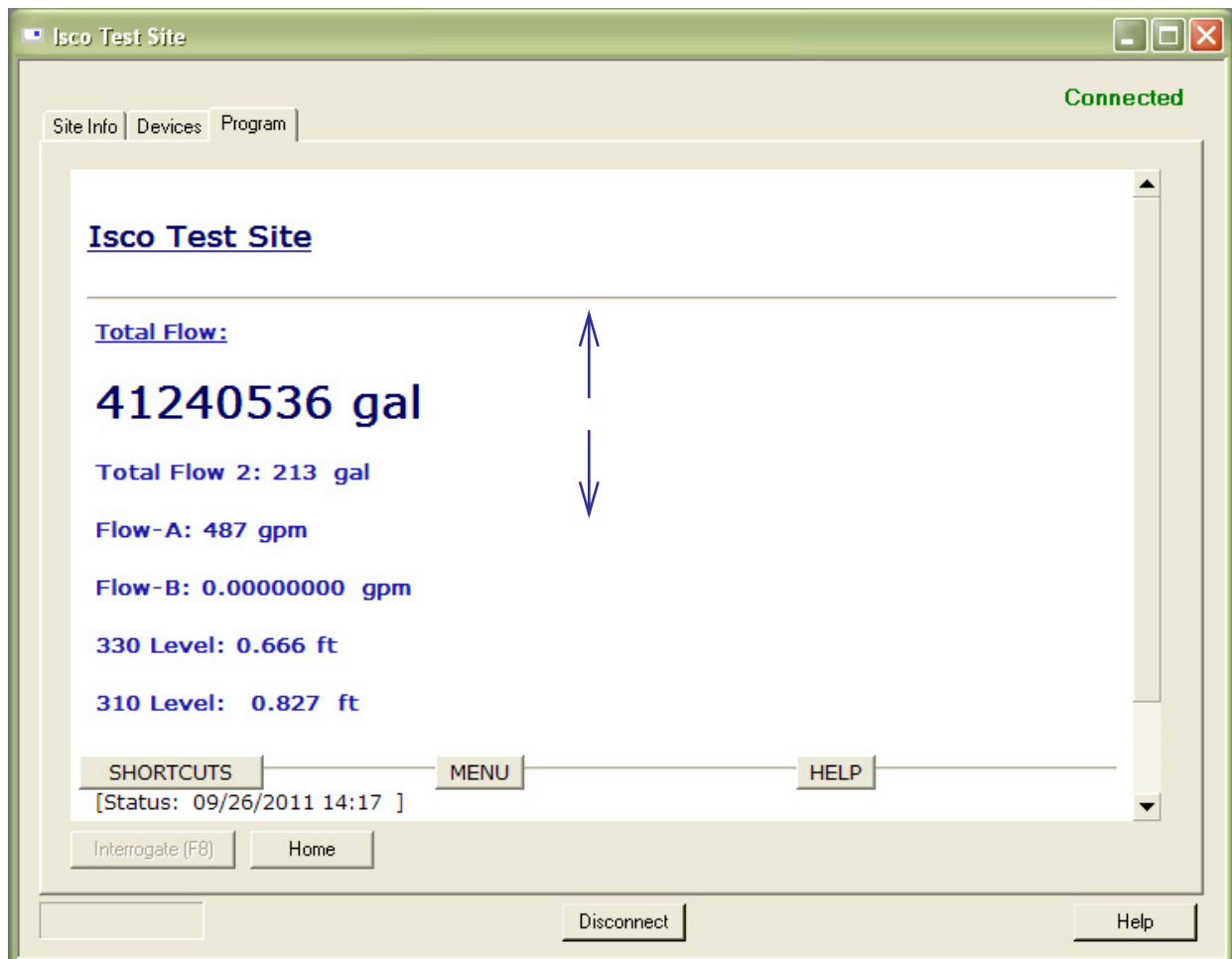


Figure 2-3 Devices tab

Program is the portal through which you access the Signature browser. The programming functions and displayed data in the browser are functions of the flow meter firmware, not Flowlink.



The Browser Window view (above) mirrors the Control Panel display (at left)

Figure 2-4 Program tab: Accessing the browser

2.2 The Home Screen

The home screen, or run screen, is displayed when the flow meter is in normal operating mode. This screen shows the current parameter readings and system status or alarm conditions.

A scroll bar on the right of the screen indicates there are more parameters off-screen that can be viewed by scrolling up or down.

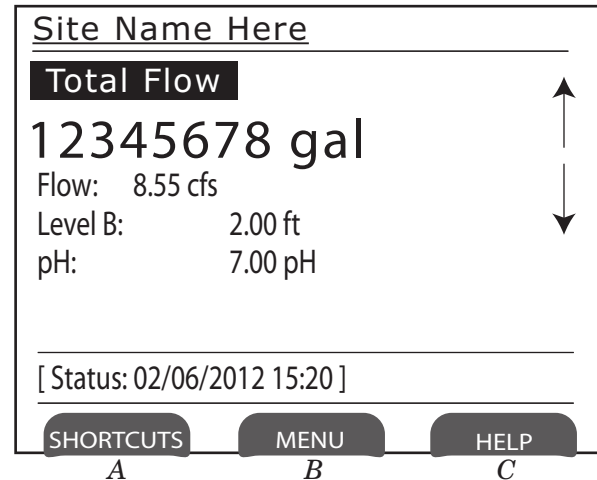


Figure 2-5 Home screen (normal operating mode)

2.3 Shortcuts

The Shortcuts menu provides quicker access to most commonly used commands, such as level adjustment or viewing data recorded over a period of time. Not all menu items described in this section will necessarily appear in your Shortcuts menu. The selections available in the Shortcuts menu are determined by what connected devices have been detected by the Signature flow meter. To access your shortcuts, press SHORTCUTS (**A**).

2.3.1 Adjust Level

To set a new level, enter the value in the field next to Level, and select Adjust. To update the current reading, select Update.

2.3.2 Adjust Velocity

This selection will open the velocity grid with current readings and laser controls for the TIENet LaserFlow velocity sensor. For complete information about this device, refer to the TIENet 360 LaserFlow user manual.

2.3.3 Purge

The Signature Bubbler flow meter allows you to manually purge the bubble line if an obstruction is suspected.

2.3.4 Histogram

The histogram displays the measurements taken of up to three selected parameters in graphical format, beginning at your selected date/time, and spanning one to 48 hours. Enter a value in the Threshold field for a reference line. The measurements available for graphing are determined by what measurements are set up for data storage.


2.3.5 Real-Time Measurement

The Real-Time Measurement will display the sensor/card options that are available. Once one is selected, a table will be displayed showing the different types of measurements the sensor/card is collecting.

2.3.6 Report View

Reporting is set up from the Configure Options menu. **Summary** displays summaries of data measurements (i.e., Min/Max/Avg). **History** tracks user and meter events. **Program** tracks changes made to the flow meter's program configuration.

2.4 Programming

To access the setup/program menus, press MENU ()

When you press MENU, the four top menu options appear:

Hardware Setup detects all devices connected to the flow meter, establishes proper communication with them, and allows configuration of each device.

Configure Options sets up the measurement site and program parameters.

Administration dictates operating preferences and perform general housekeeping tasks.

Home returns to the home screen.

Additionally,

USB Options appears when a flash drive is connected to the micro-USB assembly in the lower left corner of the control panel.

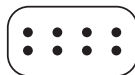
The program menus consist of steps and substeps. During programming, available subordinate menu content and steps will be determined by what you have previously entered, and what optional equipment is connected to the Signature flow meter.

2.4.1 Off-Screen Content



An arrow in the lower right corner of the flow meter's screen (see symbols at left) indicates that there is additional content on this screen in the direction the arrow is pointing. Use the arrow keys to access this content.

2.4.2 Character Grid



A small grid icon in the lower right corner of the flow meter's screen (see symbol at left) indicates that the character grid is available.

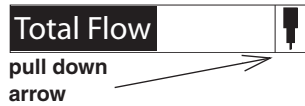
Whenever you need to enter characters, such as letters, numbers, or punctuation, press Enter to display the character grid (Figure 2-6).

Use the arrow keys to navigate to the desired character and press Enter to select. When you are finished editing, select DONE and press Enter.

Isco Test Site														
Done				Cancel										
A	B	C	D	E	F	G	H	I	J	K	L	M	N	▲
O	P	Q	R	S	T	U	V	W	X	Y	Z	a	b	
c	d	e	f	g	h	i	j	k	l	m	n	o	p	
q	r	s	t	u	v	w	x	y	z	/	:	!		
@	#	\$	%	^	&	*	()	-	_	+	=	<	
>	?	,	.											▼

Figure 2-6 Character grid

2.4.3 Pull Down Menus



Fields with a pull down arrow next to them (see example at left) indicate a pull down list. Use the arrow keys to navigate between fields on the screen; when you highlight a pull down field, press Enter to display the items on the list. Then use the arrow keys and Enter to select from the list.

2.5 Program Steps (Menu Trees)

The program steps in Figures 2-7 through 2-21 show the overall menu sequencing.

An explanation of each program step, and information specific to connected devices, is provided in Sections 2.6 *Hardware Setup*, 2.7 *Configure Options*, 2.8 *Administration*, and 2.9 *USB Options*. This information can also be viewed by pressing the Help softkey on your Signature flow meter or its browser screen.

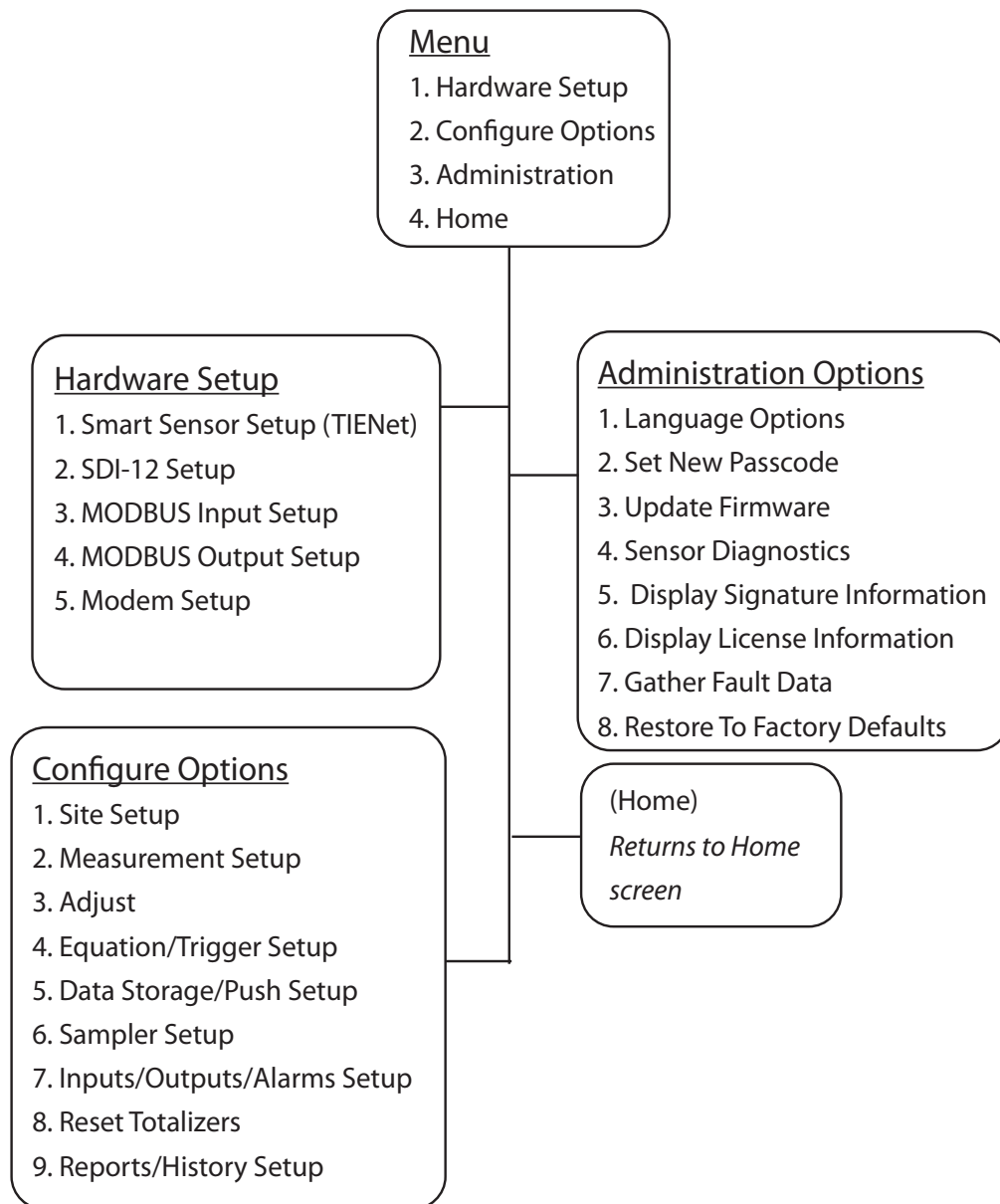


Figure 2-7 Menu Tree: Top menu

2.6 Hardware Setup

From the Hardware Setup menus, the flow meter detects and configures all connected devices.

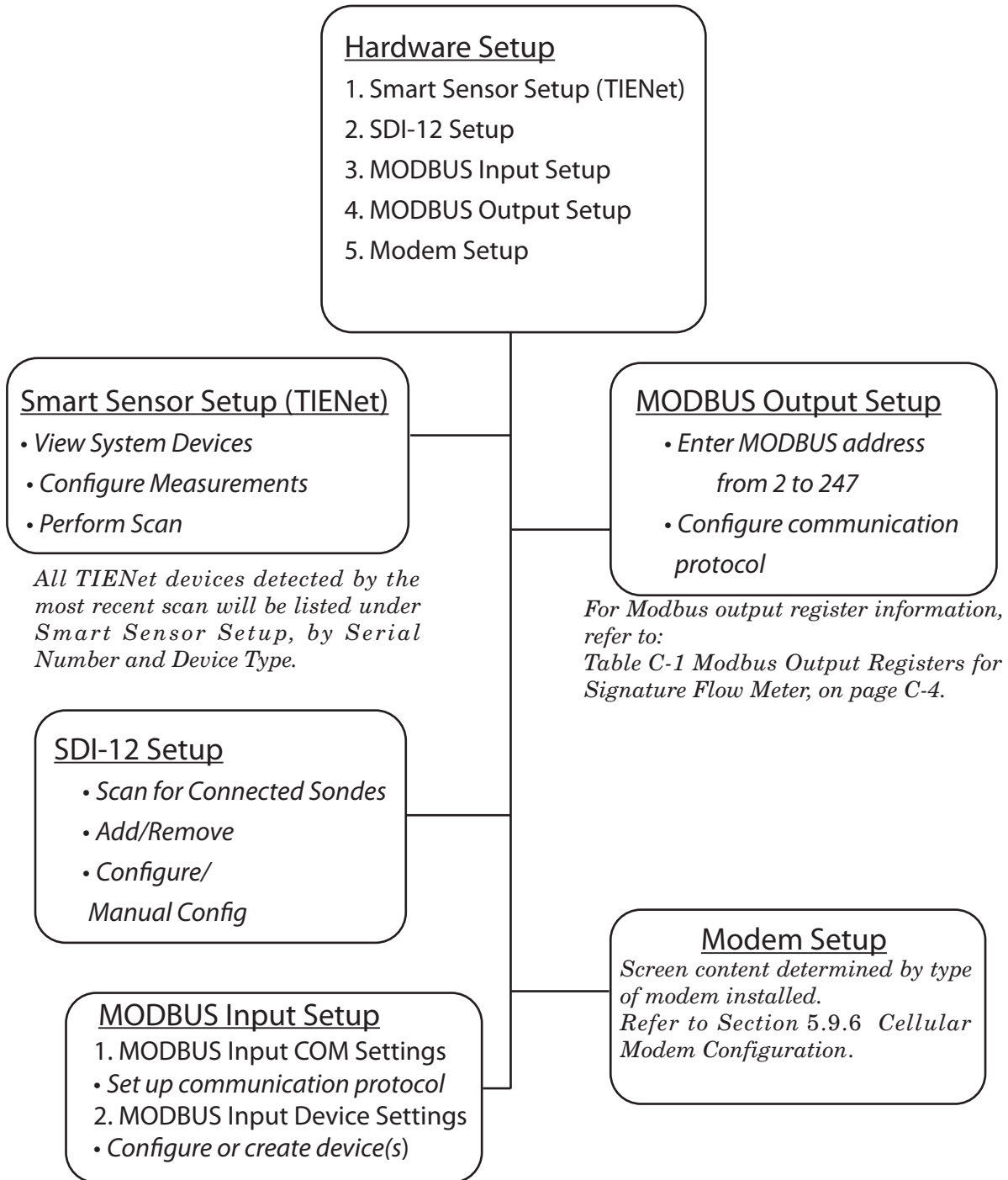


Figure 2-8 Menu Tree: Hardware Setup

2.6.1 Smart Sensor Setup (TIENet)

Perform Scan

This selection will display the most recently detected TIENet devices connected to the Signature flow meter.

If TIENet devices have been added or removed from the system, highlight Perform Scan and press Enter to detect the current system configuration.

Sensor Differences

If there are any differences in the device configuration since the last scan, a list of Sensor Differences will appear.

Missing Sensors – The Missing Sensors list will indicate any previously connected devices that are no longer detected. Select **Retain** to keep the identification information for a previous device; select **Remove** to delete it.

Replaced Sensors – The Replaced Sensors list displays any newly added sensors that have replaced Missing Sensors that have been Retained.

Additional Sensors – Displays any newly detected devices.

Following a scan, selecting NEXT from Sensor Differences will navigate to Configure Measurements.

Configure Measurements

Navigate to Configure Measurements to begin setting up measurement parameters for each TIENet device detected.

To activate a measurement, highlight the radio button next to it and press Enter. To change the name of the measurement, highlight the name and press Enter.

Regardless of what you name them, the measurement parameters for each device remain the same. For your reference, Figure 2-9 on the following page shows the position of each measurement for each type of TIENet device.

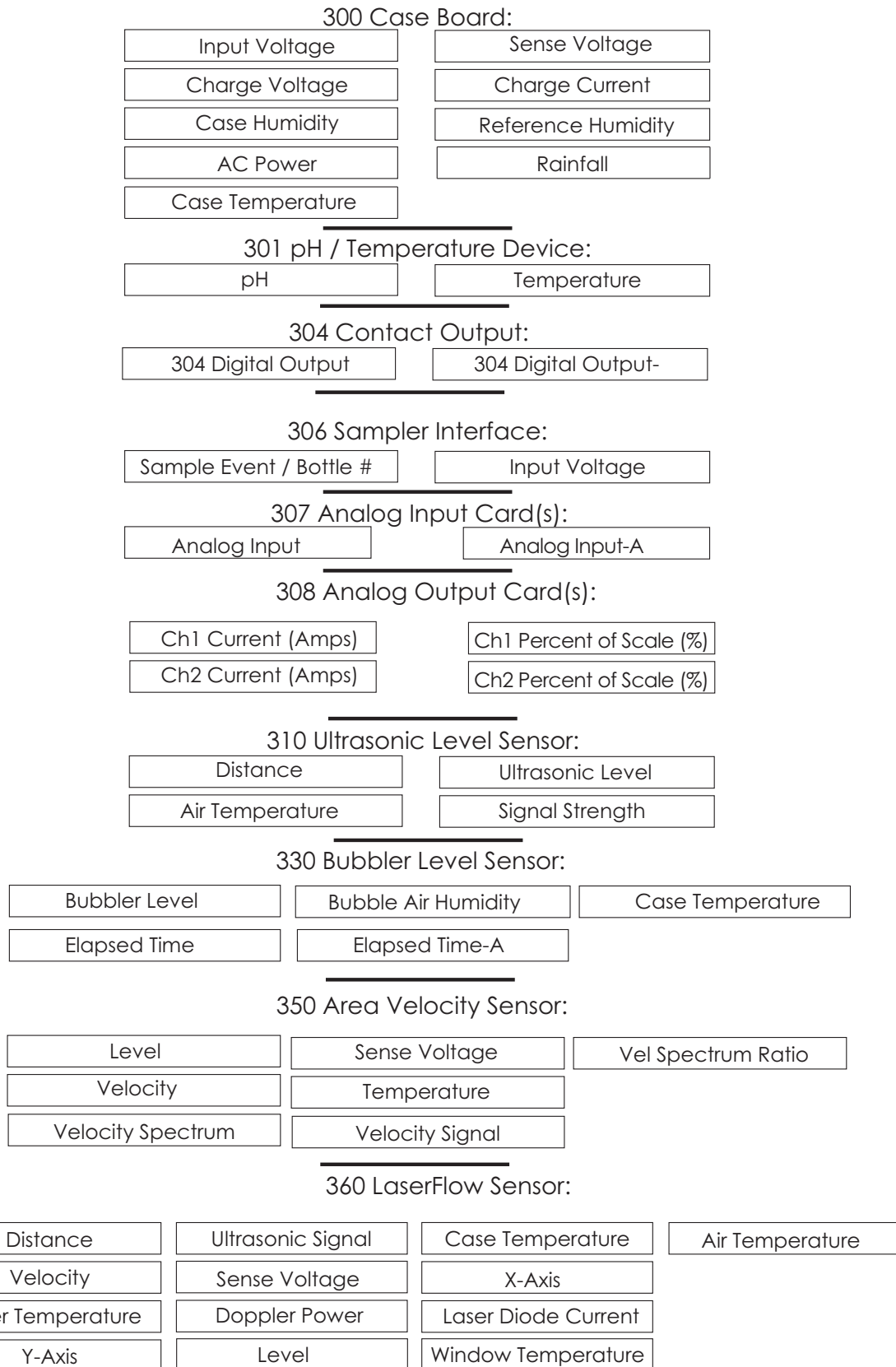


Figure 2-9 Measurement parameters for each TIENet device

2.6.2 SDI-12 Setup

Sondes detected since the last scan are displayed, with the activated sondes in the top box. If SDI-12 devices have been added or removed from the system, select Scan to detect the current system configuration. Following the scan, add/remove sondes from the Active list by selecting the sonde and clicking Add or Remove. To begin using an Isco-Ready sonde with its configured parameters, select Configure.

2.6.3 Modbus Input Setup

Connect the external Modbus input device at one of the three TIENet terminal connectors on the Signature case board as described below:

Modbus In
D1 = Yellow (+)
D0 = Brown (-)
Gnd = Black

Table 2-1 on the following page provides an example of Modbus settings for a connected DGH analog converter. The letters in the left column correspond to the entry fields shown in Figures 2-10 and 2-11.

The **multiplier** and **offset** are used to scale the raw number coming from the Modbus register(s) to represent the data in the units of measure you specify, as expressed in the following equation:

$$\mathbf{H} \text{ in units of measure} = (\text{register value} * \mathbf{J}) + \mathbf{K}.$$

In this example, the current input represents a flow rate where:

$$4\text{mA} = 0\text{cfs}, \text{ and } 20\text{mA} = 10,000\text{cfs}$$

The D1252M documentation states that it produces a register value of 0 at 0mA, and 65535 at 25mA. This means that at 4mA the register will report 10485, and at 20mA it will report 52428.

The multiplier (J) is calculated as follows:

$$10,000 / (52428 - 10485) = -2500$$

Before setting up the Modbus input function, it is recommended that you print Table 2-1 and use the empty columns provided on the right to fill in your own Modbus information.

Examples:			Table 2-1 Modbus Setup Worksheet			
	Manufacturer	DGH	Manufacturer		Manufacturer	
	Model	D1252M	Model		Model	
A	Protocol (ASCII/RTU)	ASCII	Protocol (ASCII/RTU)		Protocol (ASCII/RTU)	
B	Baud Rate	9600	Baud Rate		Baud Rate	
C	Data Bits	8	Data Bits		Data Bits	
D	Parity	None	Parity		Parity	
E	Stop Bits	1	Stop Bits		Stop Bits	
F	Device Name	D1252M	Device Name		Device Name	
G	Address	11	Address		Address	
H	Parameter	Flow Rate X	Parameter		Parameter	
I	Address ^a (Register)	30001	Address (Register)		Address (Register)	
J	Multiplier ^b	.238422	Multiplier		Multiplier	
K	Offset ^b	-2500	Offset		Offset	
L	Byte Order ^c (Endian)	Little	Byte Order (Endian)		Byte Order (Endian)	
M	Data Size (Format)	Unsigned Word	Data Size (Format)		Data Size (Format)	
N	Data Type	Flow Rate	Data Type		Data Type	
O	Units	m ³ /s	Units		Units	

- a. For 2100 update interval in seconds must be written to register 26.
- b. For assistance in calculating a multiplier and offset, contact Teledyne Isco.
- c. Big Endian = Most significant register first; Little Endian = Least significant register first.

Add/Edit Device

To begin configuring Modbus communication protocol and devices, select MODBUS Input COM Settings and use the pull down menus.

Select Modbus Input Device Settings. Enter the device name, and the device address. For Request Timeout, enter a connection retry interval in milliseconds, and the number of attempts before a connection failure is determined.

Configure Modbus communication protocol using the pull down menus. To add/edit parameter(s) for the device, select Edit Parameters.

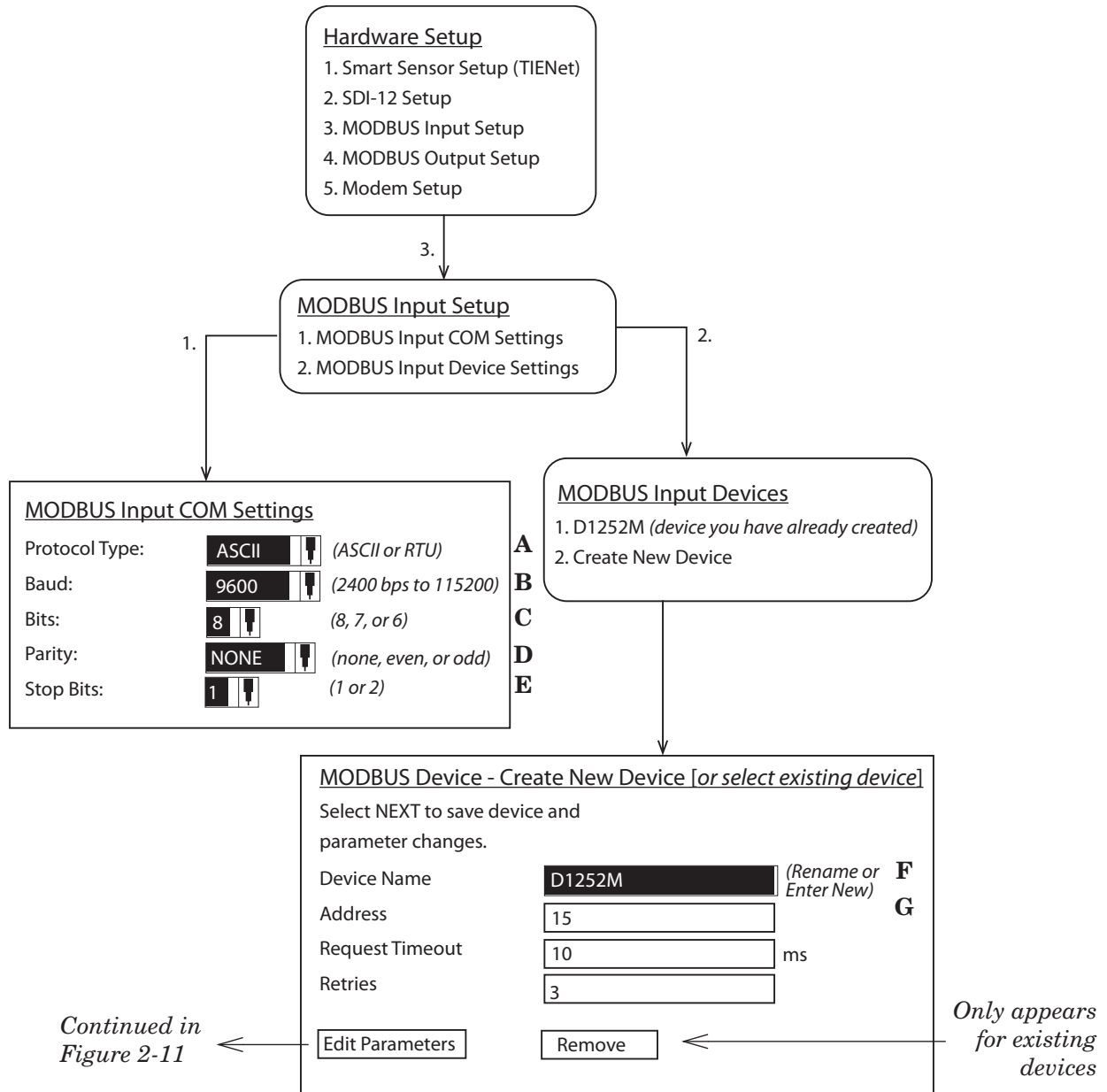


Figure 2-10 Modbus Input Setup

Note

External Modbus RTU devices cannot use addresses 1 through 10.

Add/Edit Parameters

Select an existing parameter to edit, or select Add to add a new parameter for the device. Enter a name (such as a data type), and the register address. Use the pull down menus to select other parameters.

Select Little if a multiple register parameter has the low-order data in the first register; select Big if high-order. Select data size. The available Units of Measure are determined by the data type you select.

If necessary, enter a Multiplier and Offset so the register reports a value in the units specified.

Edit Device Parameters - [parameter name]
Go BACK to the Modbus Device page in order to save changes.
1. [Existing parameter]
2. Add

Edit Parameter

Name	<input type="text" value="Flow Rate X"/>	
Address	<input type="text" value="30001"/>	
Multiplier	<input type="text" value=".238422"/>	(to scale the register)
Offset	<input type="text" value="-2500"/>	(offset applied to scaled register)
Byte Order	<input checked="" type="radio" value="LITTLE"/> <input type="radio"/> (little or big)	
Data Size	<input checked="" type="radio" value="Unsigned Word"/> <input type="radio"/> (bit, bytes, signed, unsigned, float)	
Data Type	<input checked="" type="radio" value="Flow Rate"/> <input type="radio"/>	
Units	<input checked="" type="radio" value="m3/s"/> <input type="radio"/>	(available UOM determined by data type selected)

H
I
J
K
L
M
N
O

Figure 2-11 Editing Modbus device parameters

2.6.4 Modbus Output Setup

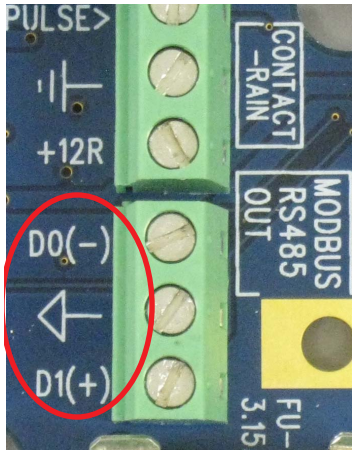
The Modbus RS-485 output function enables a SCADA system to retrieve site data from the flow meter. Connection to the flow meter is made via the RS-485 terminal on the Signature case board (shown in Figure 2-12 below).

In the **Device ID** field, enter the Signature’s address (from 2 to 247) and configure the communication protocol.

CAUTION

Be careful not to assign the same address to more than one flow meter.

For Modbus data register numbers and definitions, as well as a general explanation of Modbus output protocol, refer to Table C-1, in Appendix C *Modbus Output Protocol*.



Signature address
 (Device ID from 2 to 247) →

Hardware Setup

1. Smart Sensor Setup (TIENet)
2. SDI-12 Setup
3. MODBUS Input Setup
4. MODBUS Output Setup
5. Modem Setup



MODBUS Output Setup

Device ID:

Protocol Type: (ASCII or RTU)

Baud: (2400 bps to 115200)

Bits: (8, 7, or 6)

Parity: (none, even, or odd)

Stop Bits: (1 or 2)

Figure 2-12 Modbus Output Setup

Note

Power cycle may be required for settings to take effect.

2.6.5 Modem Setup

The menu choices displayed for modem setup depend on which modem option is installed in the flow meter. For detailed information about installation and operation of Ethernet, GSM, and

CDMA modems, refer to Sections 5.8 *Ethernet Modem* and 5.9 *Cellular Modems*.

2.7 Configure Options

The Configure Options menu is used for setting up the measurement site and setting the program parameters.

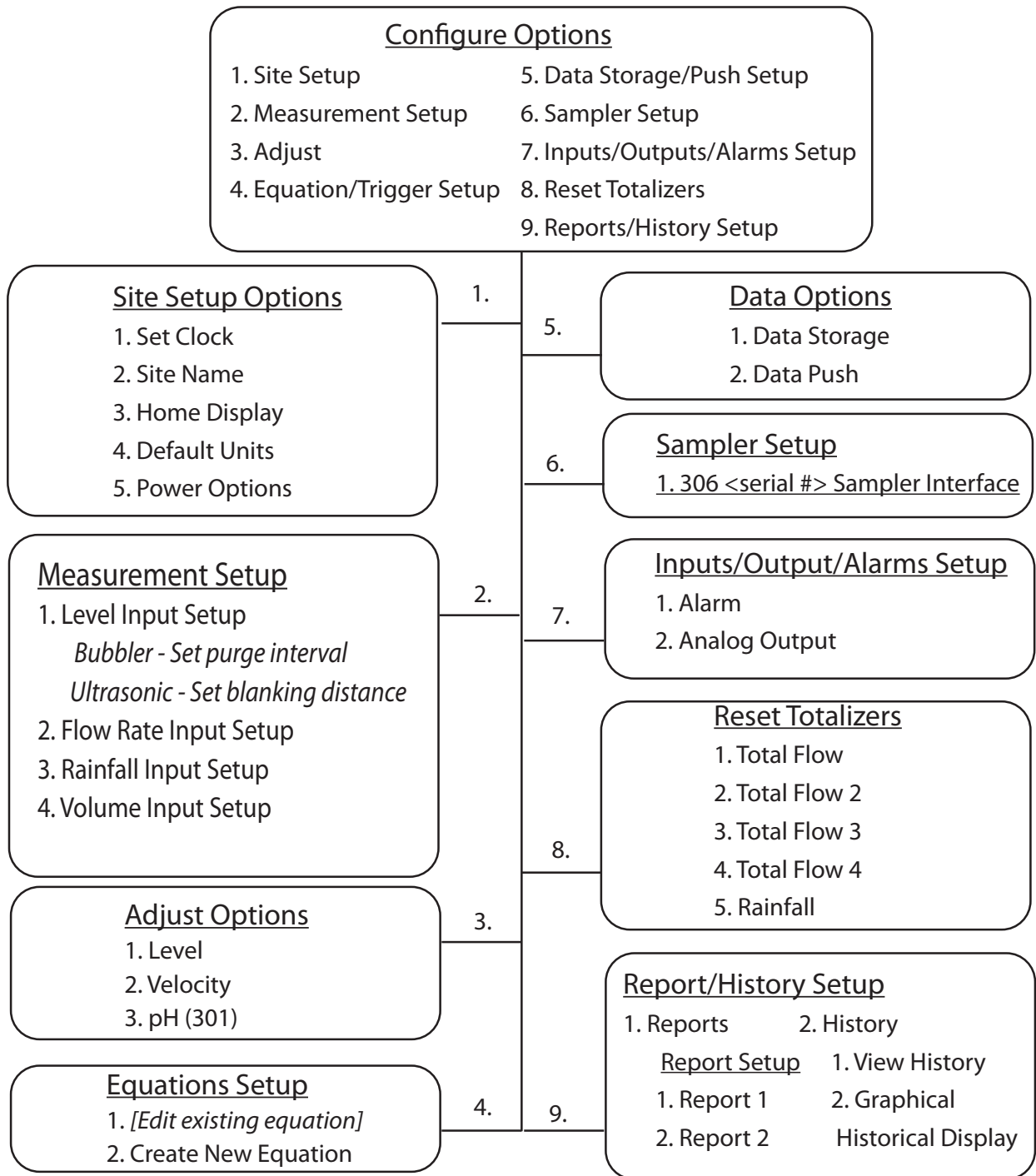


Figure 2-13 Menu Tree: Configure

2.7.1 Site Setup

The Site Setup menu sets some basic operating characteristics specific to the site.

Set Clock – Enter Year, Month, Day, Hour, Minute.

Site Name – Press Enter to display the character grid. Select one character at a time to create the desired site name.

Home Display – The Home Display determines how current measurement data is displayed on the Home screen.

From the Measurements Setup screen, select all measurement parameters to be displayed. The parameters available in the pull down menus will be determined by what devices are connected to the Signature meter.

Default Units – To set units of measure for each parameter, first select the parameter from the menu list.

The available units of measure that appear will be determined by the parameter you have selected. Under Units, highlight the units of measure and press NEXT. When finished, press NEXT again to save and exit.

Power Options – There are two power options:

- Display: will allow you to shut off the backlight and the screen.
- Low Battery Cutoff: will allow you to adjust the low battery cutoff. Refer to Section 4-4 for more power information.

2.7.2 Measurement Setup

This menu is for setting up the level measurement (Level Input Setup), flow conversion (Flow Input Setup), and flow volume totalizer(s) (Volume Input Setup). Menu items that appear are dependent on what equipment is connected to the Signature flow meter.

Level Input Setup – Under Level Setup, select the level input. Usually there will only be one listed, unless your system is using more than one level measurement device. For the TIENet 310 ultrasonic sensor, the minimum blanking distance refers to the maximum water level, and the maximum blanking distance refers to zero water level in the channel. For detailed instructions about 310 setup, refer to the TIENet 310 Installation and Operation Guide.

Flow Rate Input Setup – Measurement settings and flow conversion are programmed for the flow rate(s) from this menu (refer to Figure 2-14 on the following page). If more than one flow rate data set is being calculated, these settings are programmed separately for each one.

1. Select the flow rate to configure or select "Add Flow Rate" when two or more flow rates are present. Adding a flow rate enables calculation of flow rates dependent on condition. The flow rate also allows for configuring standard flow conversions from level inputs (e.g. level from Analog Input).

2. For level-to-flow conversions, from Measurement Settings, select the Level Input to be used in the flow calculation and the Measurement Rate (interval). Enter the name for this flow rate.
3. Select the flow conversion type to be used (Weir, Flume, Metering Inserts, Manning Formula, Area Velocity, Equation, or Data Points); then set up the conversion.

Note

Additional information about flow conversions can be found in the *Isco Flow Measurement Handbook* included with the Signature Flow Meter.

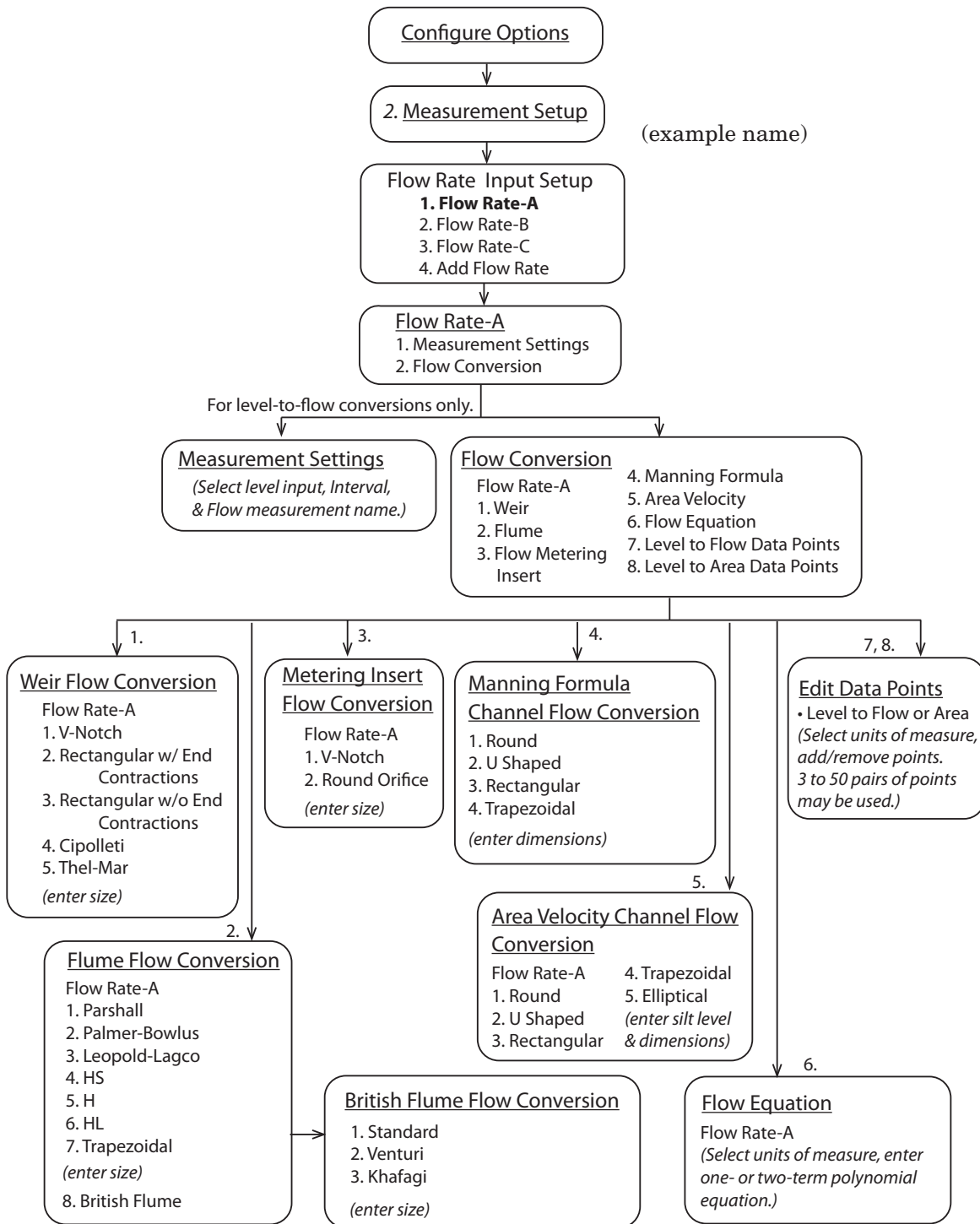


Figure 2-14 Menu Tree: Flow rate input setup

Volume Input Setup – You can set up one to four Total Flow measurements. Select the flow rate(s) used for total volume, the totalizing method (Net, Positive, or Negative), and the interval at which the total flow will be updated (between 30 seconds and 24 hours).

From the Resolution pull down menu, select the degree of resolution required for your total flow (lower = fewer digits to right of decimal; higher = more digits to right of decimal).

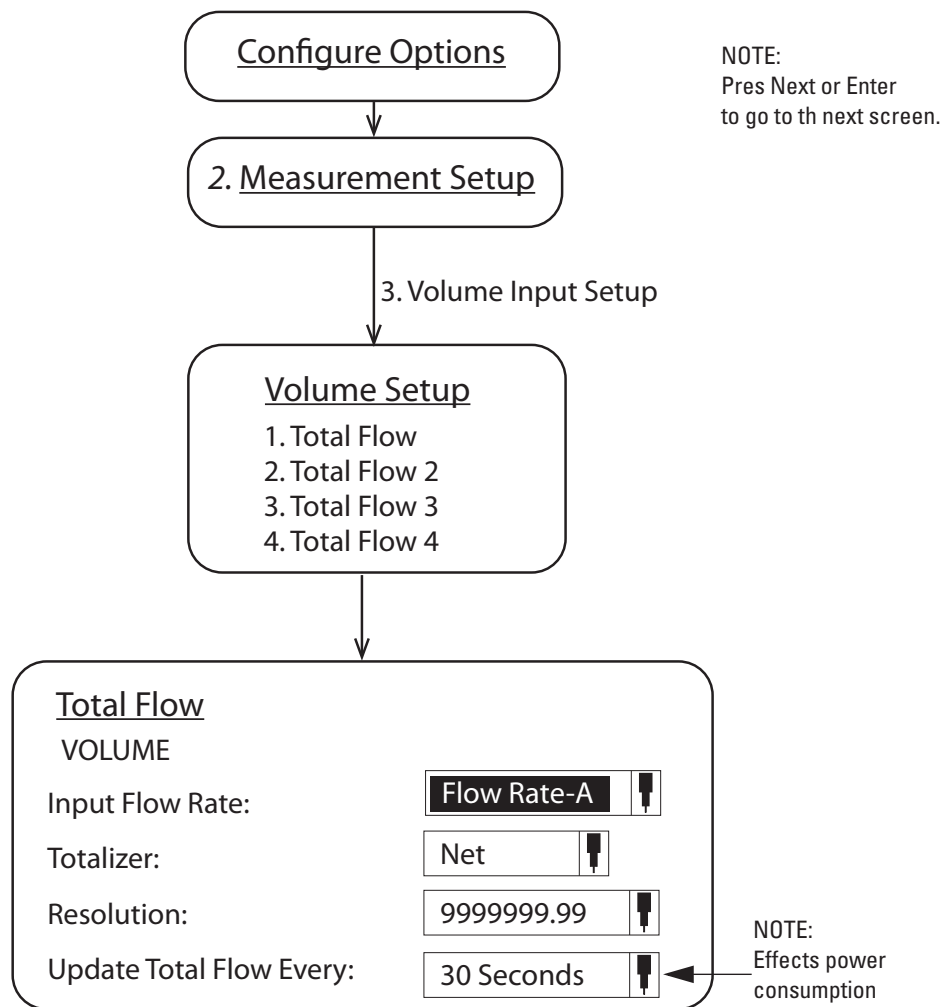


Figure 2-15 Menu Tree: Volume Input Setup (total flow)

Rainfall Input Setup – This option allows you to setup the per tip options for the rain gauge. The Automatic roll-over can be set to the time of day the rollover occurs. Once this number is reached, the roll-over will go back to zero.

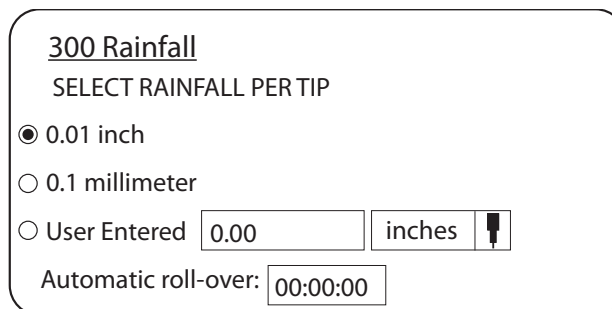


Figure 2-16 Menu for Rainfall Input Setup

2.7.3 Adjust

Adjust levels and/or velocity measurement, and/or calibrate measurement values for other connected TIENet devices. Level adjustment instructions can be found in Section *Setting the Level*, on page 3-14.

Note

For detailed instructions on calibration of a connected TIENet 301 pH device through this menu selection, refer to the 301 user manual.

Note

For detailed instructions on laser velocity measurement setup through this menu selection, refer to the LaserFlow (360) user manual.

2.7.4 Equation/Trigger Setup

Conditions are sets of site-specific, user-defined parameters. Refer to Figure 2-17 on the following page.

Equations are created from various site conditions that can be used to generate alarms, log or push data at secondary rates, trigger a connected sampler, or conserve power by turning on equipment only when needed.

Types of conditions

There are five types of conditions provided:

Range – TRUE when a measured parameter value is inside or outside specified upper and lower limits.

Rate of Change – TRUE when a measured parameter changes by a specified amount over a specified time duration.

Sensor Error – TRUE when a sensor error is present for a specified time duration.

Threshold – TRUE when a measured parameter reaches or exceeds a user-defined setpoint.

Time Table – TRUE when the flow meter's internal clock is within a defined time duration. This may be a weekly, daily, or specific one-time stop/start time.

Rain Event – TRUE when threshold is met over a period of time. Meeting threshold during the dry period will reset the Dry Period timer.

Defining conditions

To define a condition:

1. Highlight the desired condition in the lower left corner of the screen (Conditions A-F).
2. Highlight Edit Condition and press Enter.
3. Scroll down and press Enter to select the type of condition (listed above). Press NEXT to go to the configuration screen for that condition type. Press NEXT when complete.

The condition in the left-hand corner of the screen will now show the condition type.

Building equations

Build or modify the equation by navigating to the desired conditions and operators. Highlight Select Condition and press Enter again to add it to the equation. Press Enter to add a highlighted operator.

Press NEXT when complete.

Measurement Interval

When the screen is off and measurement interval is less than the data storage rate, the readings will be averaged and the battery life will slightly decrease.

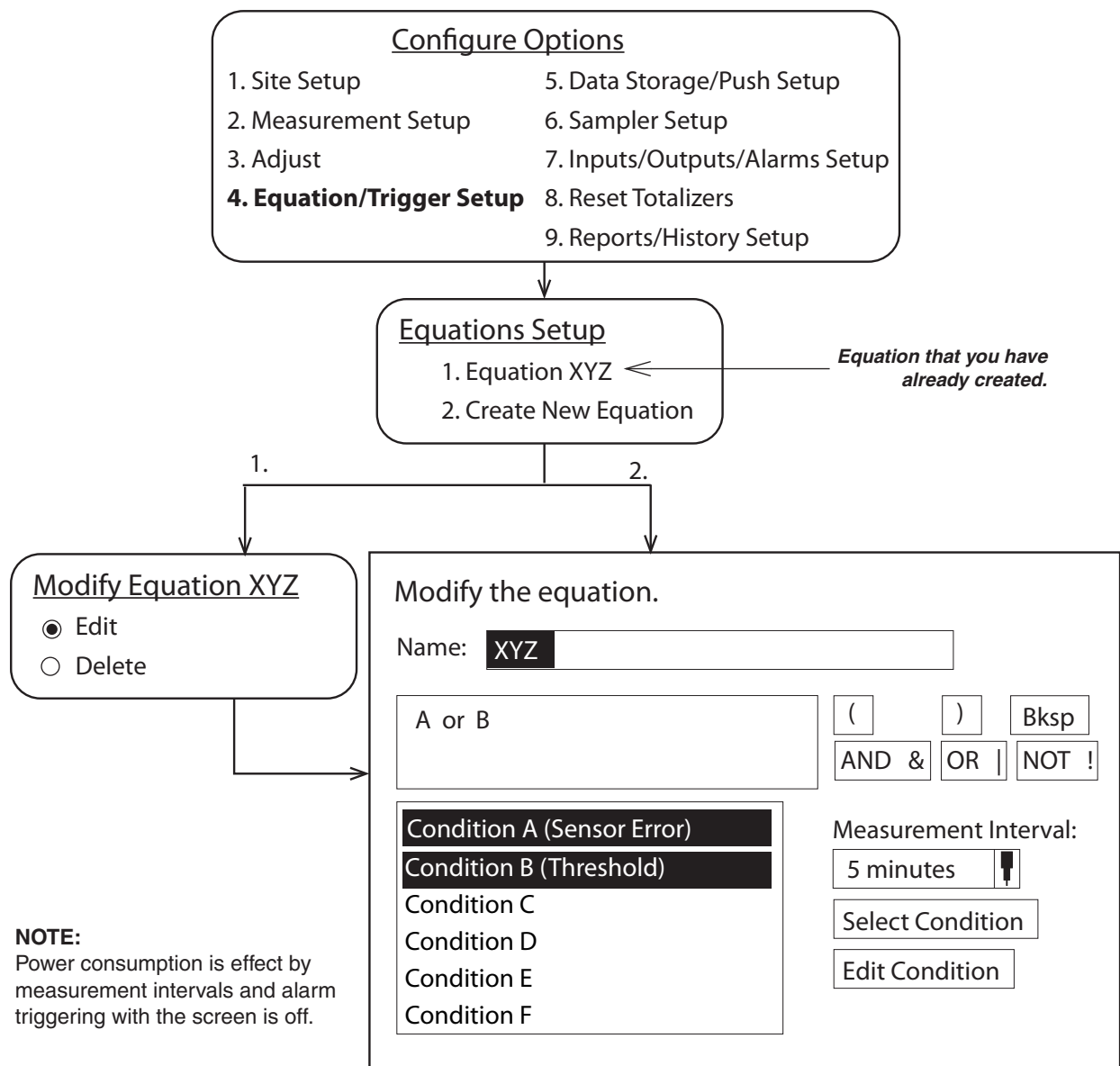


Figure 2-17 Example of defining conditions & building equations.

2.7.5 Data Storage/Push Setup

Data Storage – Set up data storage rates for a group of measurements, or separately for individual measurements. Scroll to the bottom of the screen to set up the primary storage rate, and a secondary one, if needed, with its trigger equation.

The display can be turned OFF and ON in the configure options, site setup, and power options menu. Turning the display OFF effects the way the data is recorded by the Signature meter.

- When the display is ON the Signature takes an average of the measurements over the data storage interval and records it.
- When the display is OFF the Signature takes a reading at the reading interval set in the data storage screen (no average is taken) unless alarms, triggers, or secondary measurements are active.
- When the display is OFF and if alarms, triggers, or secondary measurements are set up and the intervals are shorter than the data storage rate, the readings recorded by the meter will be an average of readings taken when the alarms, triggers, or secondary measurements were taken.

Data Push – Set up the flow meter to push data to a server running Isco Flowlink Professional software (internal modem required).

2.7.6 Sampler Setup

Program the flow meter to trigger and pace a sampler, and receive sampling information from the sampler.

Note

For detailed instructions on configuring a connected TIENet 306 Sampler Interface through this menu selection, refer to the 306 user manual.

2.7.7 Inputs/Outputs/Alarms Setup

Alarm – Configure Local, SMS text, or Server alarms based on user-defined site conditions. Under Alarm, select an alarm from the list or set up a new alarm.

Next, select an Alarm Trigger from the pull down list.

Note

The trigger(s) listed in the Alarm Trigger pull down list consist of equations you have already created based on your defined site conditions (refer to Section 2.7.4 *Equation/Trigger Setup*).

Alarms: Local

Local alarms are viewed on the Signature Flow Meter itself. When a programmed alarm condition becomes true, the LED on the front panel glows red.

To view the alarm message, press the Alarm softkey ().

For local alarm setup, refer to Figure 2-18 on the following page.

Alarms: SMS / Server

SMS and Server alarms require an optional internal modem. To configure your modem for communication, refer to Section 5.8 *Ethernet Modem* or Section 5.9 *Cellular Modems*.

Note

Server alarms notify a specified list of contacts in the event that a server running Flowlink Pro fails to receive pushed data from a site within a specified duration.

For SMS and Server alarm setup, refer to Figure 2-19.

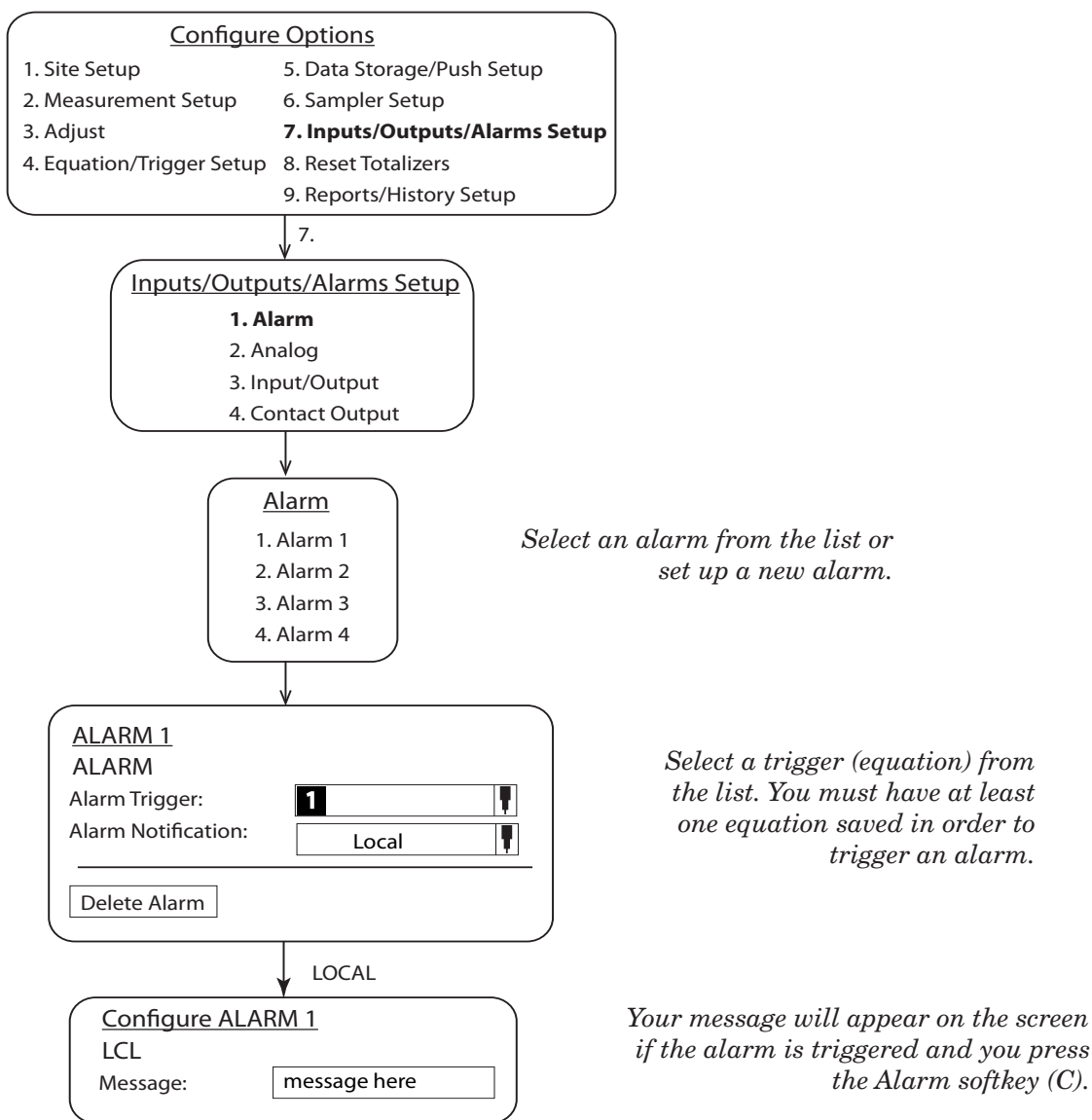


Figure 2-18 Local alarm setup

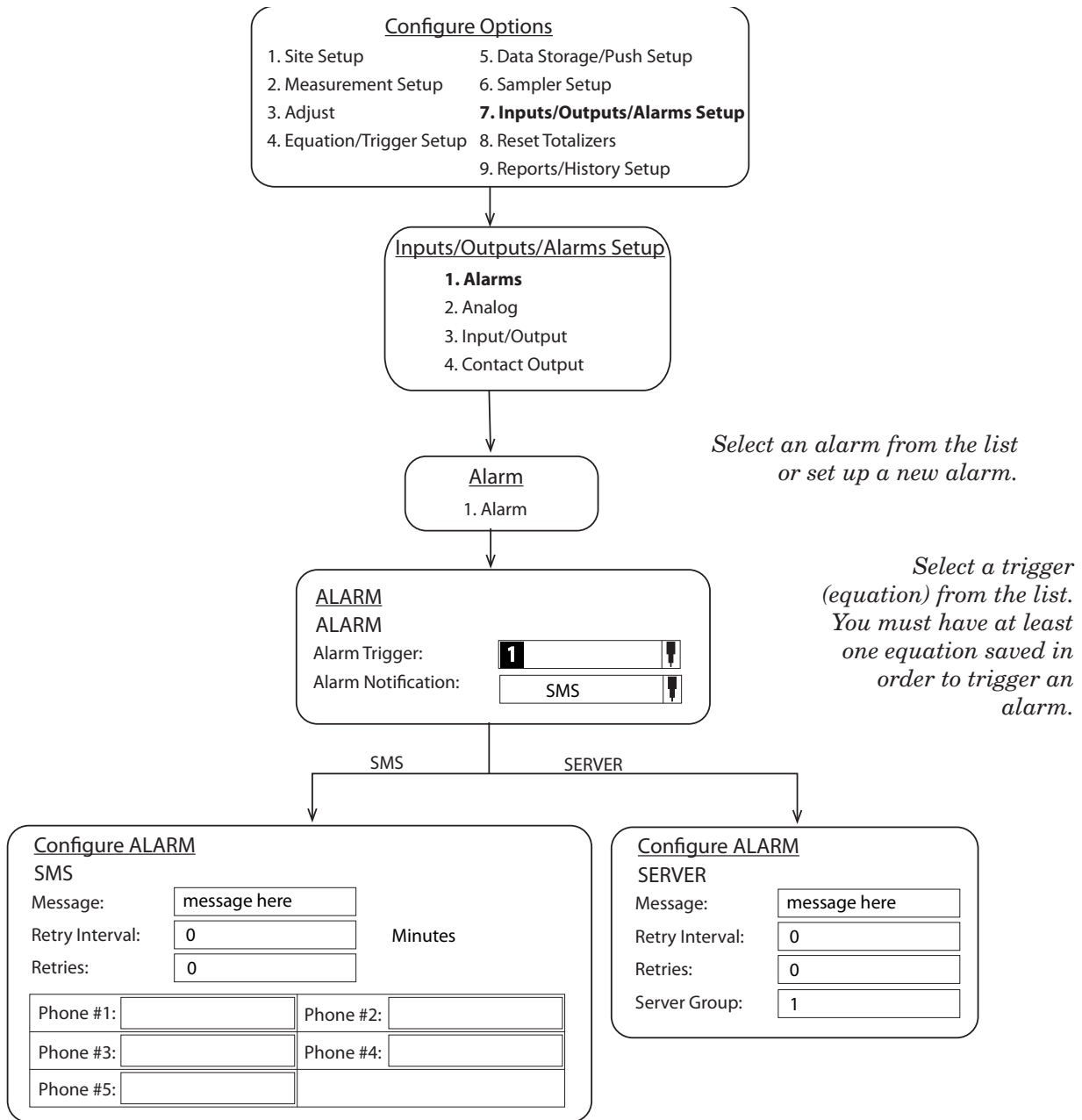


Figure 2-19 SMS and Server alarm setup (modem required)

Analog Output – Select the output to configure, then select and configure the measurement the output will represent. TIENet 308 option card required (see Section 5.6.10).

Analog Input – Select the input to configure, then select and configure the measurement the input will represent. TIENet 307 option card required (see Section 5.6.9).

Contact Output – Select the output to configure, then select and configure the measurement the output will represent. TIENet 304 option card required (see Section 5.6.8).

2.7.8 Reset Totalizers

Select the flow volume totalizer(s) to be reset. Selection resets the totalizer to zero.

2.7.9 Reports/History Setup

Reports – Set up report interval and measurements to include for one or two reports. To include all user and meter events in the report, select the option Include history log.

History – Display user and meter events (i.e., log-ins, adjustments, data push, etc.), and/or set up the graphical display for selected measurements over a period of time.

2.8 Administration

Administrative settings (see following page) dictate operating preferences and perform general housekeeping tasks.

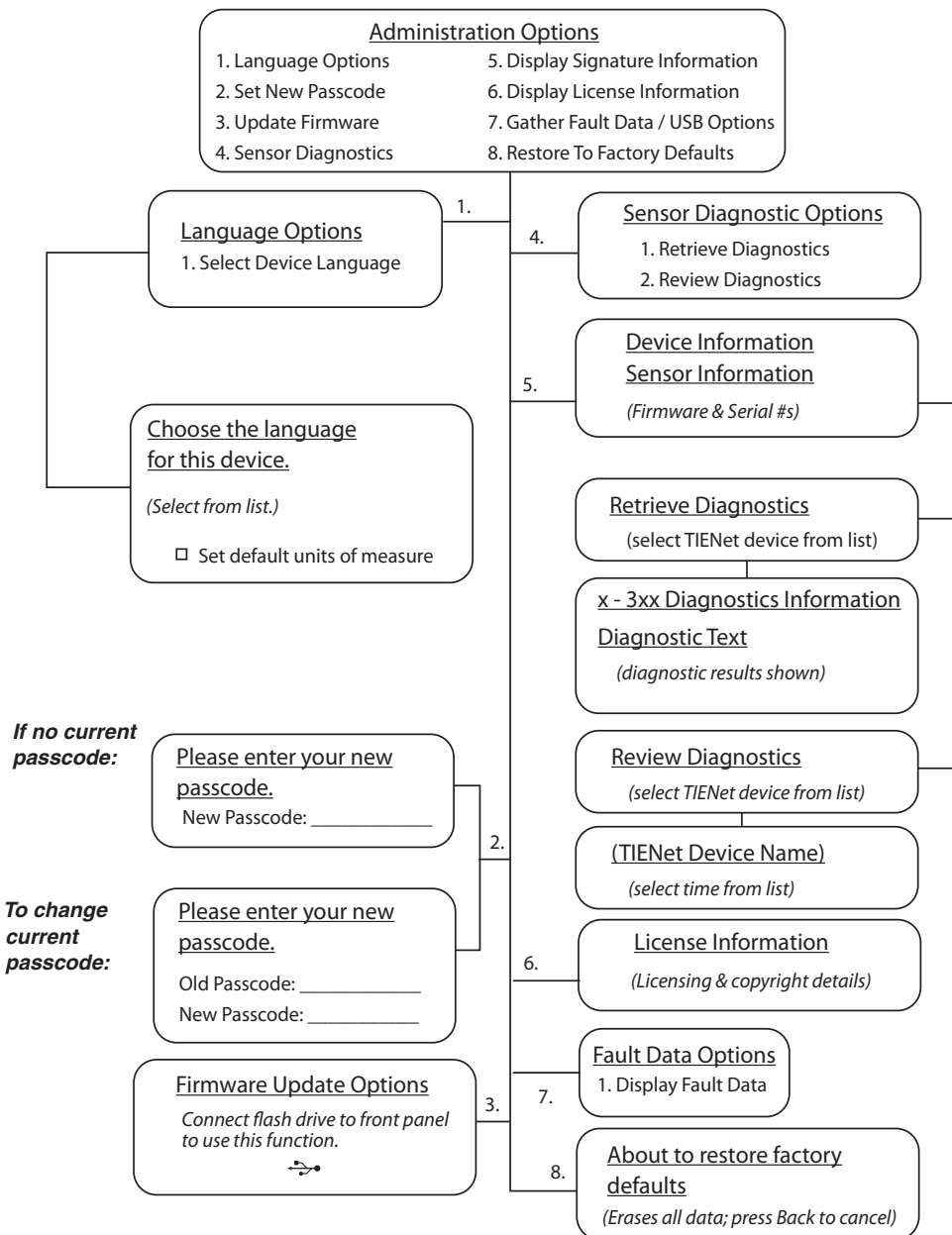


Figure 2-20 Menu Tree: Administration

2.8.1 Language Options

Select Device Language – From the list, select the default language to be displayed by the Signature flow meter. Available languages include:

English (USA)	Dansk	Português (Brasil)	Deutsch
English (International)	Nederlands	Español (México)	
Français	Türk	Svenskt	

From this screen, you can also set general default Units Of Measure to USA or International. You can still select units of measure for individual measurements through Configure Options > Site Setup.

Note

Power cycle may be required for settings to take effect.

2.8.2 Set New Passcode

A numerical passcode can be set to protect access to programming and data. By default, the flow meter is not passcode-protected. To change an existing passcode, enter the current passcode, and then the new passcode. To remove the passcode requirement, enter a new passcode of 0 (zero).

2.8.3 Update Firmware

To use this function, first connect a flash drive loaded with the correct firmware update file(s) to the micro-USB assembly. Refer to Section 2.9 *USB Options* for complete instructions.

2.8.4 Sensor Diagnostics

The Signature provides operating data for each connected TIENet device upon request, for site evaluation or troubleshooting purposes.

To generate a new diagnostic report, select **Retrieve Diagnostics**. The available devices can then be selected from a list. When the diagnostic data is available, press Enter to view it.

To view past diagnostic reports, select **Review Diagnostics** and select from the list of devices. Each past diagnostic report will be listed by date and time.

Diagnostic reports can also be downloaded to a connected USB flash drive in the form of a text file. Refer to *Retrieve Text Reports*, on page 2-33 for complete information.

Note

If you are running diagnostics on a 360 LaserFlow velocity sensor, the Distance in the text report and graph are relative to the face of the integral ultrasonic transducer, which is located 11.7" above the bottom of the sensor. Subtract 11.7" from the Distance shown to obtain the actual value.

For more information about the LaserFlow sensor, refer to Section 5.6.3 *Laser Doppler Velocity Sensor* and the LaserFlow user manual.

- 2.8.5 Display Signature Information** Select this option to view the serial number, model number, software revision, and hardware revision of the Signature flow meter and any connected TIENet devices.
- 2.8.6 Display License Information** This selection displays open-source licensing and copyright information for the Signature firmware.
- 2.8.7 Gather Fault Data** Fault data is a term describing the capture of any user and/or flow meter activity prior to and during a system error or failure. This data can be displayed to assist in troubleshooting. To download the data to a flash drive, connect a flash drive to the micro-USB assembly on the front panel of the Signature and select Gather Fault Data from the USB Options menu that appears (refer to Section 2.9 *USB Options*).
- 2.8.8 Restore to Factory Defaults** This function returns the Signature Flow Meter to the program that was installed the factory. This is an example program that can be used for reference when designing your own program.
If the restore to portable defaults check box is selected, the power savings options will be automatically turned on.
Be sure to record your own program settings and save all data before restoring the factory defaults.
- 2.8.9 Home** HOME returns to the home screen.
- 2.9 USB Options** The USB Options menu will only appear when you connect a flash drive to the micro-USB assembly on the front panel of the Signature.

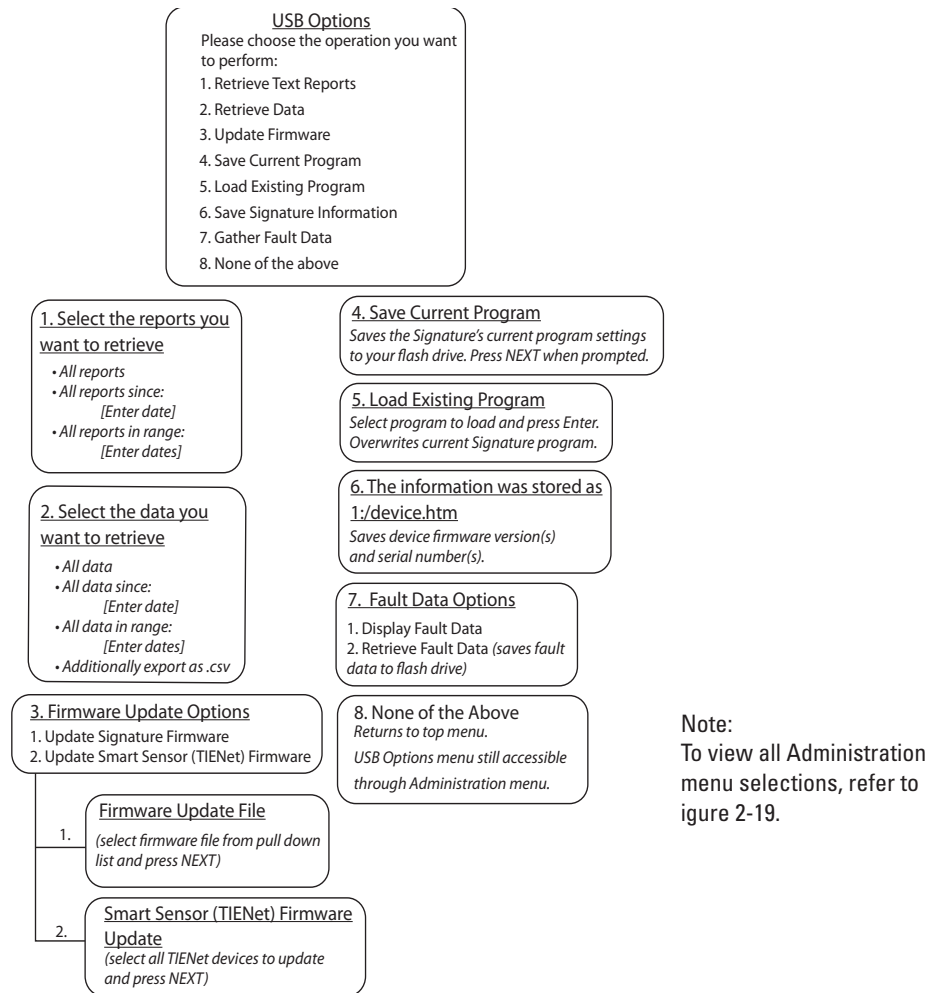


Figure 2-21 Menu Tree: USB Options

2.9.1 Retrieve Text Reports

Select this function to download the Signature data text reports for sensor diagnostics and verification of data integrity.

Select “All reports,” or specify a start date or date range, and press NEXT. The reports will be stored on the connected flash drive in a folder called "ISCO."

This folder contains a sub-folder for each site, named with the first eight characters of the site name. The site folder contains one or more sub-folders, named by retrieval date (YYYYMMDD).

Each report file name has a prefix of one or two letters, followed by four digits representing the time of day, e.g., PH0935.TXT is a program report generated at 9:45 a.m.

Each report is contained in a text file, with a .TXT extension, or in a Smart Sensor Diagnostic file, with a .SSD extension. Each report file has a corresponding authentication file, with a .ath extension, for verification purposes. For more information about report verification, refer to *Verifying Exported Reports*, on page 2-36.

The four validation report types are:

Program Report (PH) – Tracks changes to the Signature Meter’s configuration

Summary Report (R1 / R2) – Documents summaries of data measurements (e.g. Min/Max/Avg)

Diagnostic Report – Tracks the occurrence of, and results from, diagnostic tests

History Report (H) – Tracks user and meter events (e.g. level adjustments, calibration, data push, etc.)

2.9.2 Retrieve Data

The program settings and flow data can be downloaded onto your flash drive in .ddp (data dump) format.

Select “All data,” or specify a start date or date range, and press NEXT. The data will be stored on the connected flash drive in a folder called “ISCO.”

This file can then be imported into Flowlink, where it can be viewed in regular site file format, with the recorded data and report/graphing capability.

There is a check box that, when checked, will export the .cvs file onto a USB flash drive.

2.9.3 Update Firmware

With a USB flash drive connected to the Signature’s front panel, the Update Firmware option becomes active on both the Administration menu and the USP Options menu.

For step-by-step instructions for updating the firmware for either the Signature flow meter or connected TIENet devices, refer to *Firmware Updates*, on page 6-2.

2.9.4 Save Current Program

Select this option to save a copy of the Signature’s current program to your USB flash drive. You can also use this information to program other meters with the same configuration.

2.9.5 Load Existing Program

Select this option to load a saved program from your flash drive. Note that selecting this option will cause the current program to be overwritten with the one from the flash drive.

In order for the Signature to load the correct program, the name of the site must match that of the site program that was saved.

2.9.6 Save Signature Information

This option saves a snapshot of the firmware version(s) and serial number(s) of the Signature and any connected TIENet devices.

2.9.7 Gather Fault Data

Fault data is a term describing the capture of any user and/or flow meter activity prior to and during a system error or failure. This data can be viewed and/or downloaded as a file to your flash drive to assist in troubleshooting.

2.9.8 None of the above

This item returns the screen to the top menu.


However, as long as the flash drive remains connected, the USB Options menu will still be active, and can be reopened from the Administration menu.


2.10 Signature Data in Flowlink


To download flow and event data from the Signature Flow Meter into the database with Flowlink, connect to the flow meter and select Interrogate (F8), or Import ddp (data dump).

2.10.1 Event Viewer

By default, Flowlink's Event Viewer displays the four event data types in tabular format, with a time stamp and short description of the event for each entry (refer to Figure 2-22). Each event type is represented by a graphical symbol, located in the first column:



Program 

Summary Reports 1 & 2 

Diagnostic 

History (User / Meter Actions)  Meter Actions include Data

Push - start/fail/complete, and Power Up/Down; all other events are user events (i.e., calibration, changes to the program, totalizer reset, etc.).

If the data for that event is unaltered, a green check mark  appears next to it. If the data cannot be verified as authentic, a red slash  appears next to it.













Type	Auth	Event Time	Event Summary
		2/17/2011 11:00:00 ...	Report Signature Site Interval: 2011-02-18T06:00:00 to 2011-02-18T08:42:19 Voltage: 13.527621
		2/17/2011 11:00:01 ...	Report Signature Site Interval: 2011-02-18T10:00:00 to 2011-02-18T11:11:34 Voltage: 12.807129
		2/14/2011 11:00:00 ...	
		2/15/2011 7:20:30 PM	LOGGED_IN
		2/16/2011 1:41:30 PM	LOGGED_IN
		2/16/2011 3:22:50 PM	LOGGED_IN

Figure 2-22 Event Viewer in Flowlink

Printing reports

Select one or more rows in the viewer to be printed and then select the Print button.

Exporting reports

To save event data as a text report for future verification, highlight the desired row(s) in the Event Viewer table and click Export (or right-click and select Export).

The default destination is your My Documents folder; however, you can change this to another preferred destination, including a USB drive, if preferred. A message window will notify you when the export is complete.

The files you exported are saved using the following hierarchy:
SITENAME \ MODULENAME \ DATE.

2.11 Verifying Exported Reports

Flowlink will only export already verified reports; they can also be verified after being retrieved from the Signature, either via Flowlink export or USB flash drive download.

Verification of exported data reports is done using the **Report Verification tool**, a small application installed separately when Flowlink was installed. This tool is located in the Flowlink program folder, normally at C:\Program Files\Flowlink 5.1, and

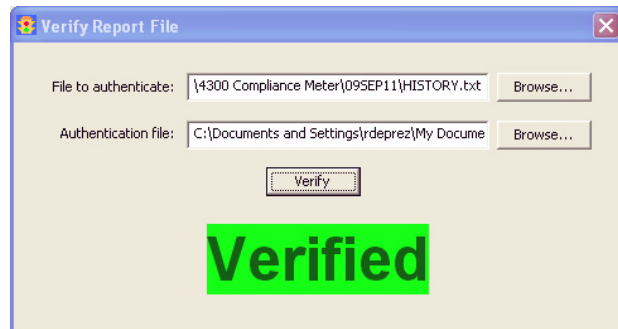
is identified with a traffic light icon



Note that this tool can also be used to verify data exported directly to a USB drive using the USB Options menu (refer to Section 2.9).

Use the top Browse... button to navigate to the desired report (*.txt or *.SSD) file. Use the bottom Browse... button to navigate to its corresponding authentication (*.ath) file. Click Verify. The application will quickly return a message showing the verification result.

Data is authentic.



Data has been altered.

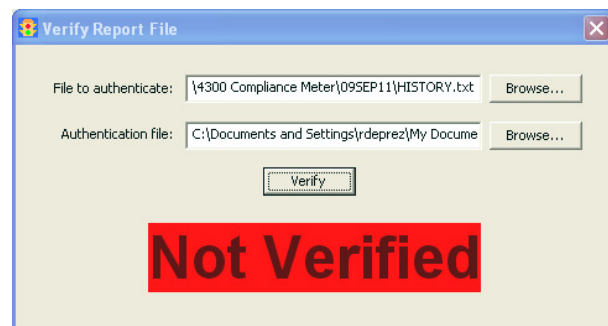


Figure 2-23 Report file verifier

Signature® Flow Meter

Section 3 Standard Installation

This section contains physical preparation procedures and permanent mounting methods for the Signature Flow Meter and associated Teledyne Isco equipment. Section 4 will contain the installation information for the Signature Portable Flow Meter.

WARNING

The installation and use of this product may expose you to hazardous working conditions that can cause serious or fatal injury. Take all necessary precautions before entering a worksite. Install and operate this product in accordance with all applicable safety and health regulations and local ordinances.

3.1 Introduction

The Signature Flow Meter is used for permanent installations.

3.2 Connecting External Devices

External device cables and mains line cord are passed, usually via conduit or cord-grip fittings, through the port holes in the bottom of the case and wired directly to the connector case. Cable fittings are also available for Rain, Ethernet and option card circuits as a 3 hold cord grip.

Trimming unterminated wires prior to installation is recommended.

Tools Required:

- Small flat screwdriver (3.5mm)
- #2 Phillips screwdriver
- Channel locks
- Soldering iron (for tinning wires)

DANGER

Before opening the case, first ensure that mains power is disconnected from the unit.

CAUTION

Before opening the case, disconnect the optional battery or battery backup power, if used.

Note

Before restoring mains power, ensure that the flow meter's USB connector does not have a cable attached.

Open the door to access the two large screws holding the front panel on the connector case. Remove the two screws, then reinsert them in the front panel and latch the lid so they will not be misplaced.

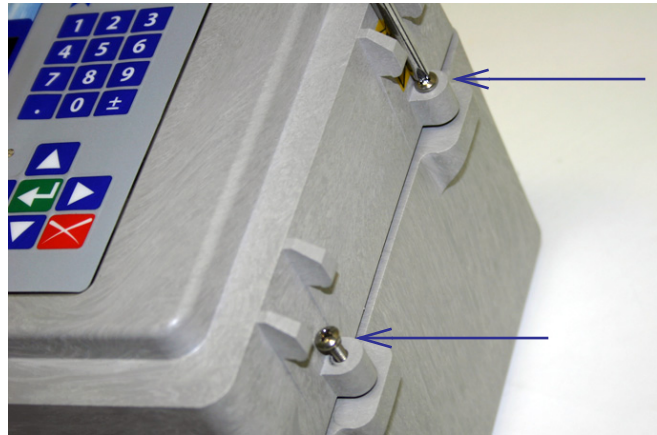
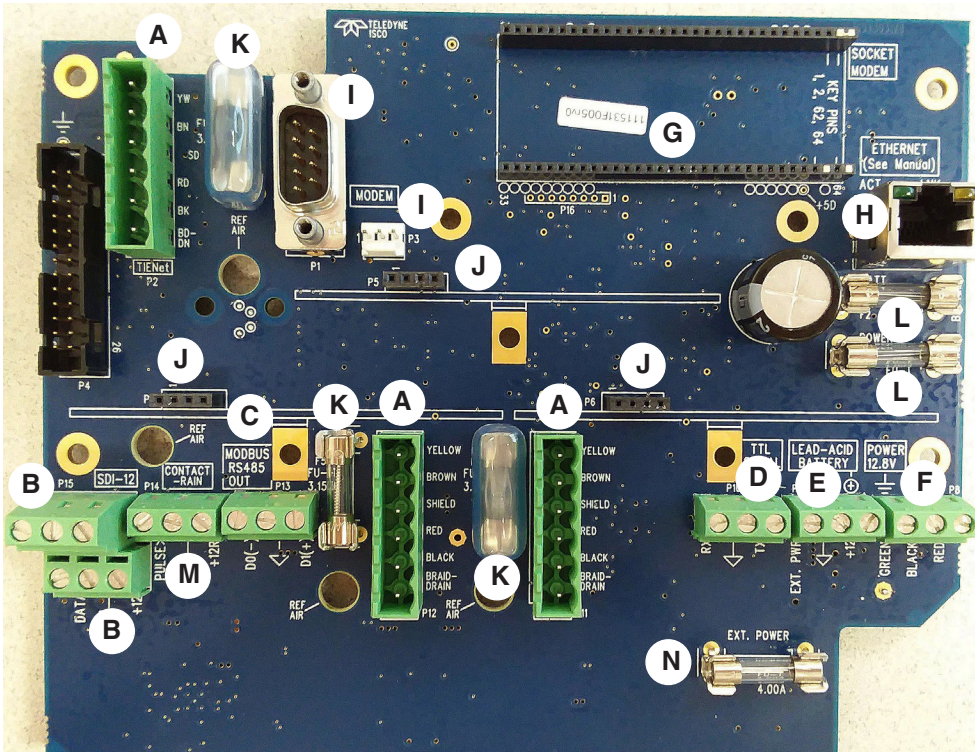


Figure 3-1 Open door and front panel to access interior

Open the front panel to access the connector case. Connectors on the board are identified in Figure 3-2.



	External TIENet Devices/
A	Modbus RS485 In D1 = Yellow (+) D0 = Brown (-) Gnd = Black
B	SDI-12 Input
C	Modbus RS485 Out
D	TTL Serial
E	Battery Backup/ Battery for Portable Ext Pwr input
F	12.8 VDC
G	Ethernet Modem
H	Ethernet Port
I	Cellular Modem (power & serial)
J	4-20mA Input/Out- put Card and Contact Output Card
K	Fuse "T" 3.15A
L	Fuse "T" 4.00A
M	Rain Gauge
N	Fuse "T" 4.00A

Note: No power supply for Signature Portable Flow Meter

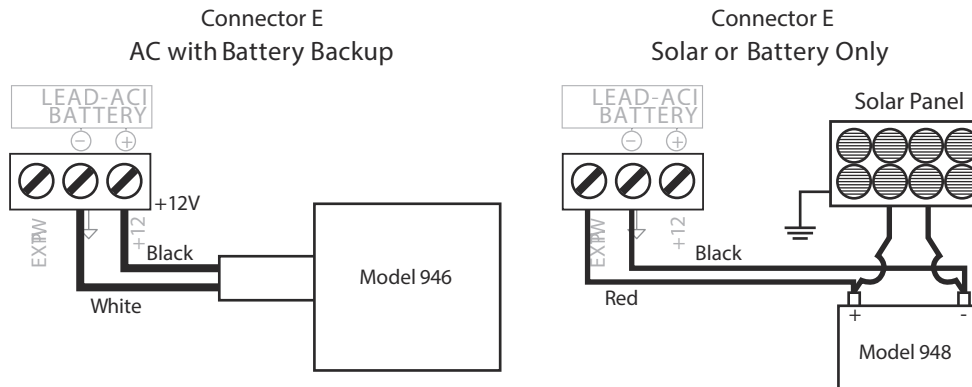


Figure 3-2 Connector case, connectors, and fuses

Note

The two TIENet connections satisfy most applications. If additional TIENet connections are needed, consider the two TIENet Expansion Box versions for standard installations or TIENet 'Y' cables for Portable Signature applications. See Appendix B for ordering information.

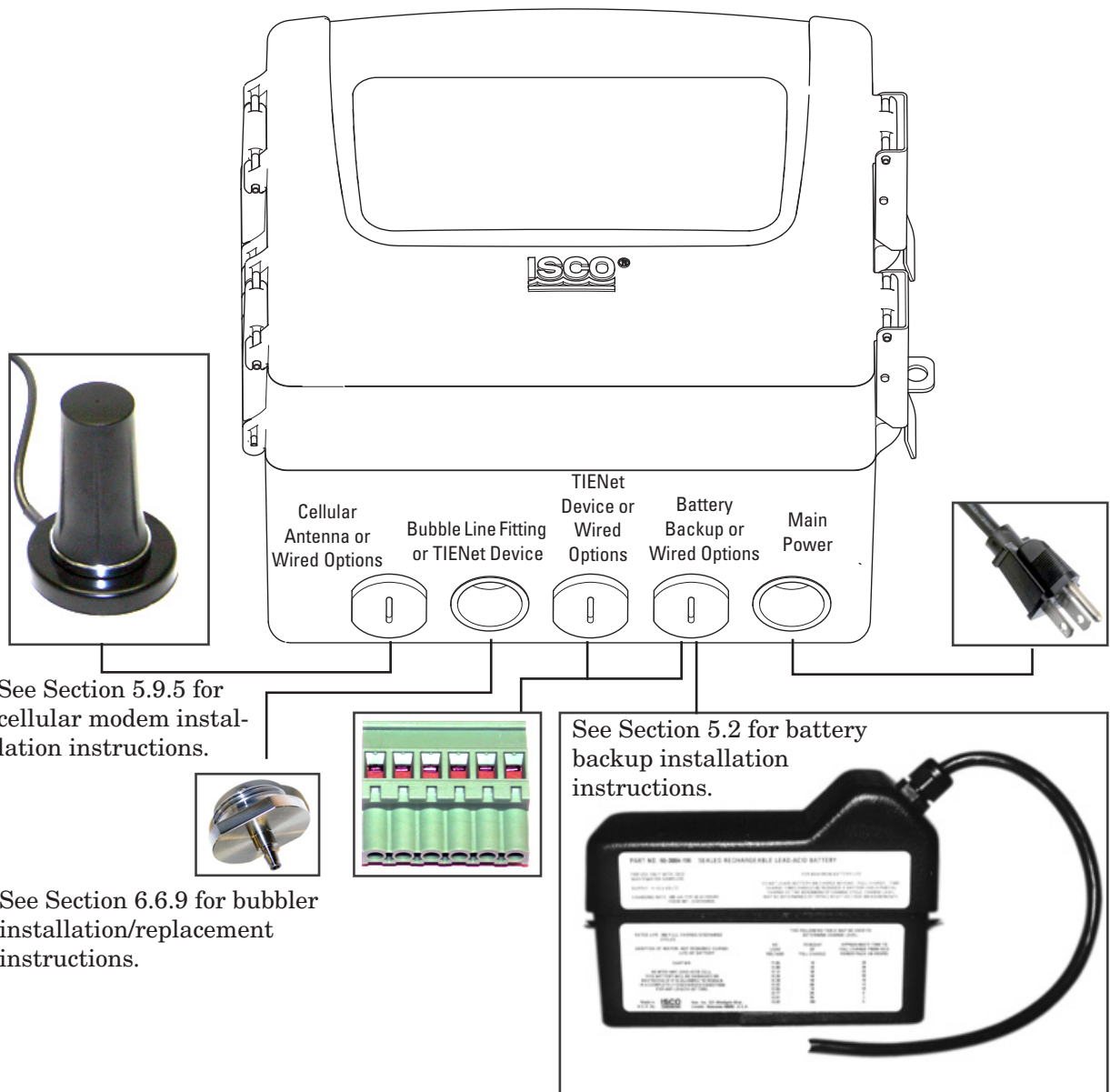
3.3 Case Bottom Cable Entries

The connections made through the cable entries depend on the application, but their most common uses, in accordance with the connector case layout, are depicted on the following page.

All optional cable entries must use appropriate ID conduit connections or cord-grip fittings to retain the IP66 rating. If you are using non-TIENet or non-Signature cables, you must supply the appropriate ID conduit connections or cord-grip fittings.

CAUTION

If you are using conduit instead of the cord-grip fitting, the conduit and wires must be sealed to prevent harmful gases and moisture from entering the Signature enclosure. Failure to seal conduit could reduce equipment life.



See Section 5.9.5 for cellular modem installation instructions.

See Section 6.6.9 for bubbler installation/replacement instructions.

See Section 5.2 for battery backup installation instructions.

Figure 3-3 Connector Case cable entries for power and external devices

3.3.1 Cable Fittings

Cord-grip fittings for TIENet devices, line cord, and battery backup option are available from Teledyne Isco (see Appendix B for ordering information). Cable fittings are also available for rain, ethernet, and optional card circuits as a 3-hole cord grip.

The fitting for the line cord is a special strain-relief fitting, as shown in Figure 3-5.



Figure 3-4 Strain relief ³/₄ NPT Cord-grip fitting for TIENet devices



Figure 3-5 Cord-grip fittings installed

Any unused cable entry holes should be sealed with plugs. Do not overtighten the plugs. When a plug is flush against the outside of the case and held in place by the metal nut inside, the hole is sealed.

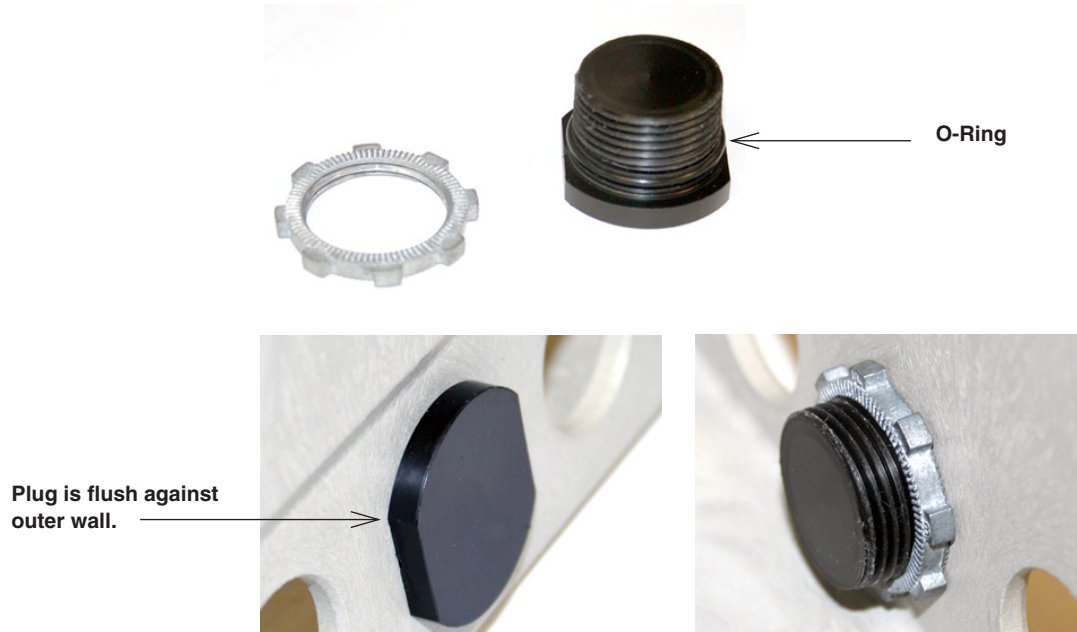


Figure 3-6 Diameter-seal plugs for unused ports

3.3.2 Connecting TIENet Devices

The optional external TIENet devices compatible with the Signature flow meter all connect in the same manner. Multiple TIENet devices can be connected simultaneously to the same Signature Flow Meter.

✓ Note

The steps that follow include instructions for installing cord-grip fittings. Some applications will use user-supplied $\frac{3}{4}$ " ID conduit for cable routing.

1. Remove one of the 6-position plug-in terminal strip connectors from the connector case.

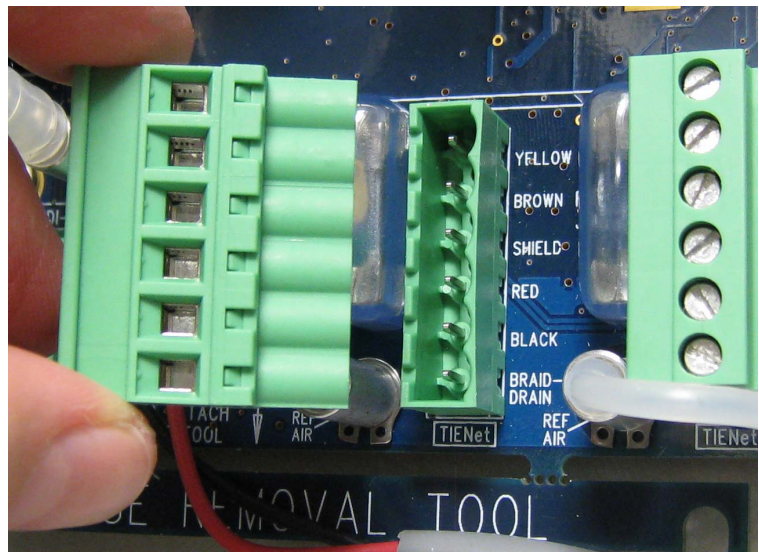


Figure 3-7 TIENet Device terminal strips

2. If using a cord-grip fitting, install the cable nut in the appropriate opening on the bottom of the Signature enclosure, securing it to the wall with the lock nut (concave side facing wall).
3. Feed the TIENet device cable end through the sealing nut and seal, and through the cable nut. Lightly tighten the sealing nut, just enough to hold the cable in place while installing the connector.

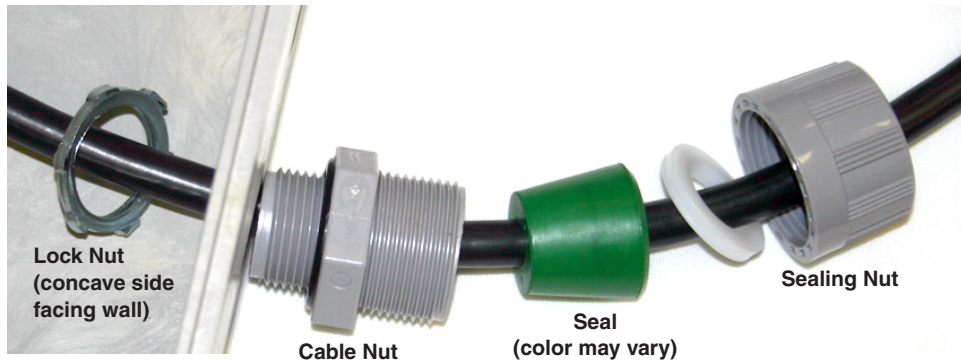
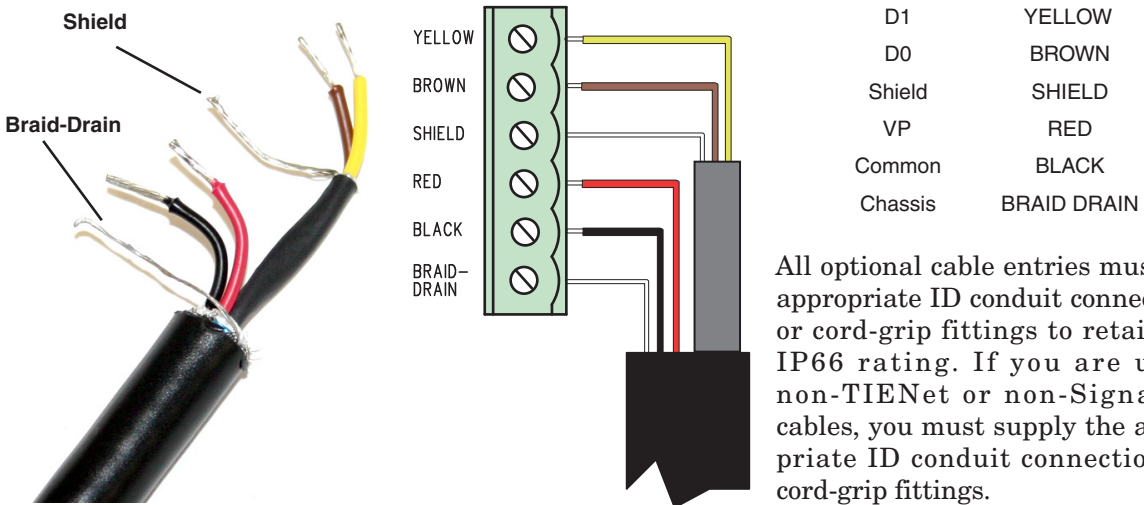


Figure 3-8 Installing TIENet cable with a cord-grip fitting

4. Attach the wire ends to the terminal strip as shown in Figure 3-9, then press the terminal strip back down into its socket on the case board, as shown in Figure 3-10, taking care not to strain any wire connections. Gently tug each wire when finished, to verify secure connection to the screw terminals.

Note

The SHIELD wire is the bare drain emerging from the foil shield around the YELLOW and BROWN wires. The BRAID-DRAIN wire is the bare drain emerging from the surrounding braided shield inside the cable jacket. It is not necessary to prevent the two braids from coming into contact with each other.



All optional cable entries must use appropriate ID conduit connections or cord-grip fittings to retain the IP66 rating. If you are using non-TIENet or non-Signature cables, you must supply the appropriate ID conduit connections or cord-grip fittings.

Figure 3-9 TIENet Device terminal connections

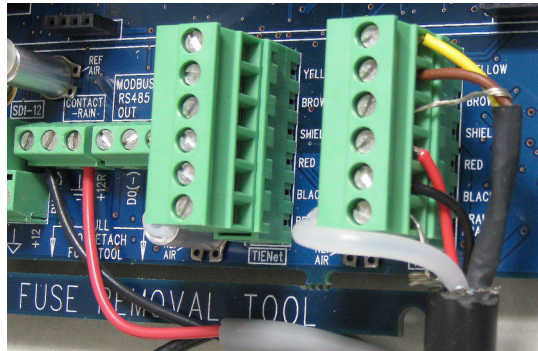


Figure 3-10 Attach wired terminal strip to connector case socket

a. **Systems using the LaserFlow or Area Velocity 350 Sensor:**

Insert the reference tubing into the REF AIR port on the case board, pushing it down inside the silicon tubing. Be careful not to kink the reference tubing.

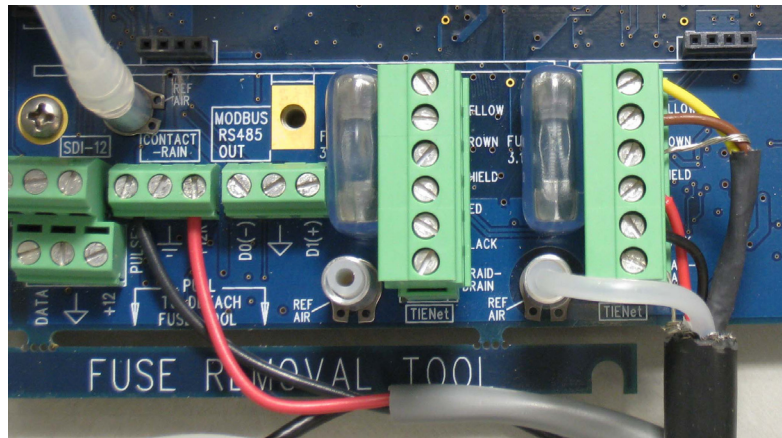


Figure 3-11 Insert the cable reference tubing into the case board reference port

5. Tighten the cord grip sealing nut.

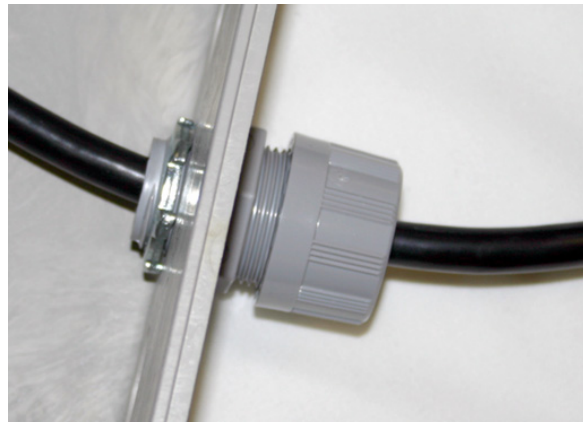


Figure 3-12 Position and secure the cable

6. Close the front panel and fasten it shut with the two Philips screws.

CAUTION

If you are using conduit instead of the cord-grip fitting, the conduit must be sealed to prevent harmful gases and moisture from entering the Signature enclosure. Failure to seal conduit could reduce equipment life.

3.4 Power

The Signature is in compliance with North American and International safety standards while the input voltage remains within 100-240 VAC (50/60 Hz).

For external current protection, a 2 A slow-blow or time-lag fuse between mains power and the Signature is recommended to accommodate up to 40 A inrush current at power up in applications up to 230 VAC.

The flow meter comes with the internal power supply wired to the connector case, and held in place by a screw (see Figure 3-13 on the following page). Mains power is wired into the Signature's internal power supply, normally via a standard three-wire line cord or hard-wiring through user-supplied conduit.

Note

The Signature flow meter must be installed in accordance with the National Electric Code (NEC) NFPA70 for installation in the United States, or the Canadian Electric Code (CEC) for installation in Canada, or other local installation codes as applicable.

3.4.1 Hard Wiring

Cable entries for hard wiring must use appropriate ID conduit connections.

CAUTION

If you are using conduit instead of the cord-grip fitting, the conduit and wires must be sealed to prevent harmful gases and moisture from entering the Signature enclosure. Failure to seal conduit could reduce equipment life.

If the instrument has been hard-wired for power, ensure that a switch or mains circuit breaker is installed near the instrument for easy access to remove power in the event of an emergency.

3.4.2 Line Cord

If the instrument has been fitted with a line cord, ensure that its installation is near a mains outlet for easy access to remove power in the event of an emergency.

3.4.3 Power Connections

Teledyne Isco offers an AC line cord kit that is installed at the factory when ordered with the Signature. It is also sold separately, and is easily installed by the user.

For installation instructions, refer to Section 5.1 *AC Power Cord Kit /AC Wiring (Applies to Permanent Installation Only)*. **Note that these instructions can also be used as guidance for user-supplied line cord, hard wiring, or replacement power supply.**

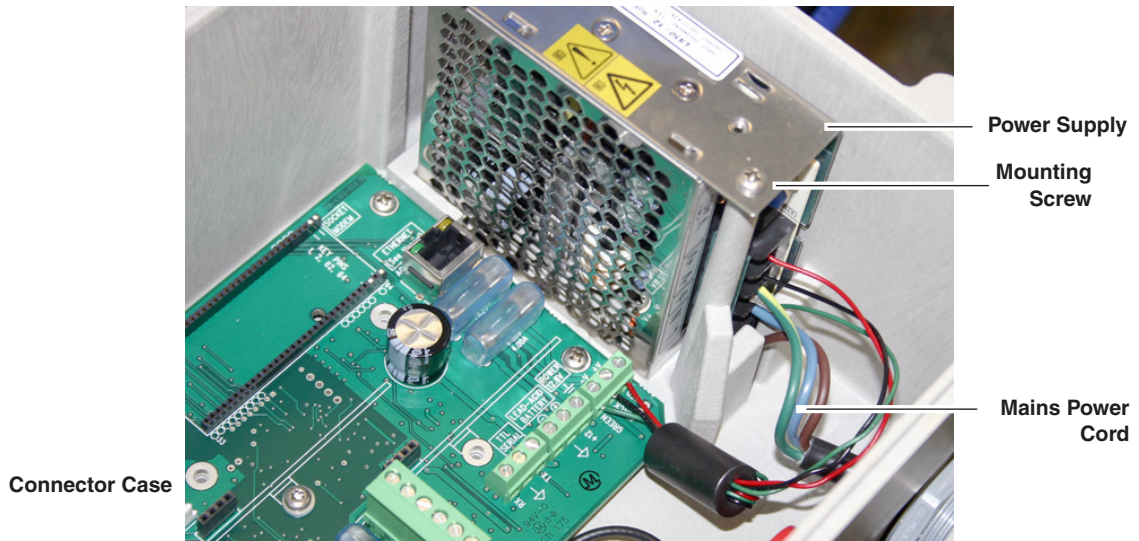


Figure 3-13 Location of power supply

3.5 Mounting the Signature

The Signature can lie flat on a horizontal surface, or be attached to a wall using the stainless steel bracket on the back of the case. It can also be installed inside a console enclosure with other system components. If a console enclosure is used, ensure that it provided proper sealing to protect the flow meter and other equipment from harsh environments and/or moisture.

The mounting location should allow for easy removal and reinstallation in the event that cleaning, testing, or replacement is required. Refer to the dimensional drawings on the following pages for physical installation specifications.



Figure 3-14 Signature Flow Meter mounted on wall

3.6 Outdoor Recommendations

Where the Signature Flow Meter is mounted outdoors, a weather shield for protection from direct sunlight and rain is recommended. The shield should accommodate the flow meter's 18 inch dimensions with the cover opened, as shown below.

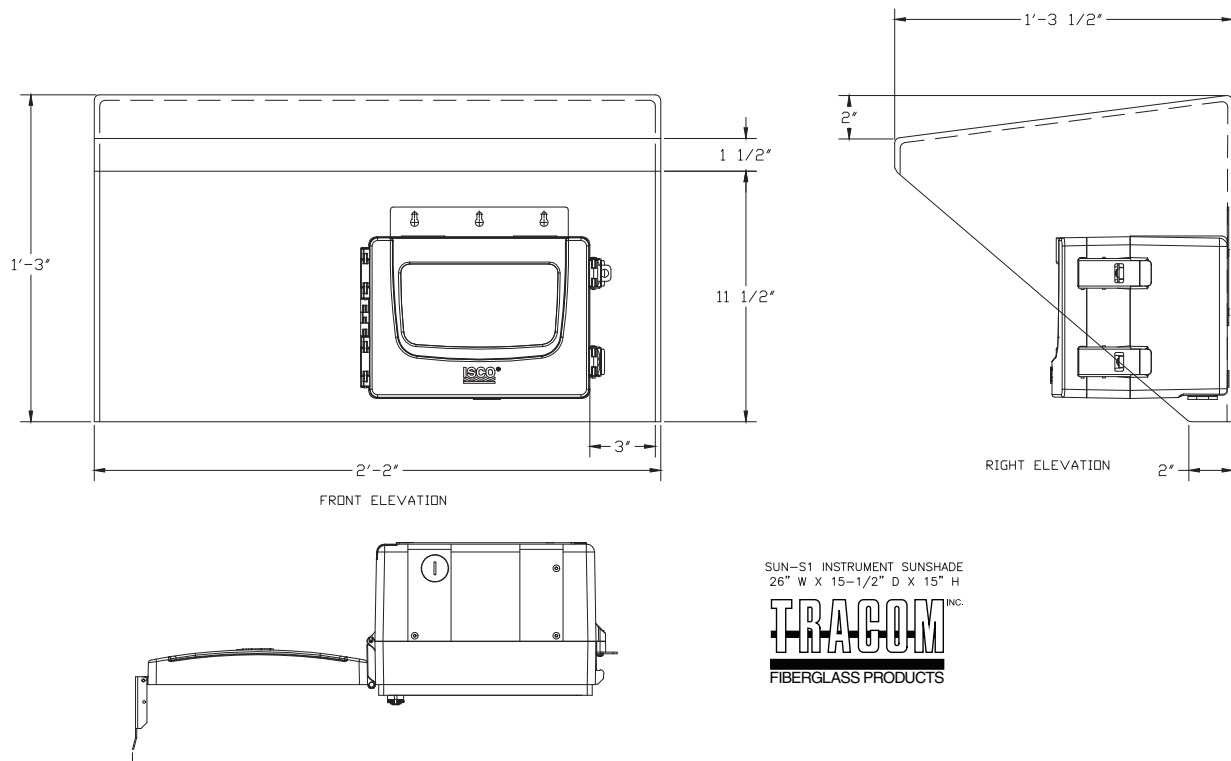


Figure 3-15 Weather shield - recommended for outdoor installations
(Drawing & Photo courtesy of TRACOM, Inc.)

3.7 Setting the Level

Although all other programming steps can be performed off-site, the liquid level must be set at the measurement site following installation.

Once the 330 bubble line is installed in the flow stream, or the 310 sensor is installed over the flow stream, measure the present liquid level and enter this value for Level, under Configure > Adjust Options. Highlight “Adjust” and press Enter to confirm.

From this screen, you can also update the display to show the current level of the stream.

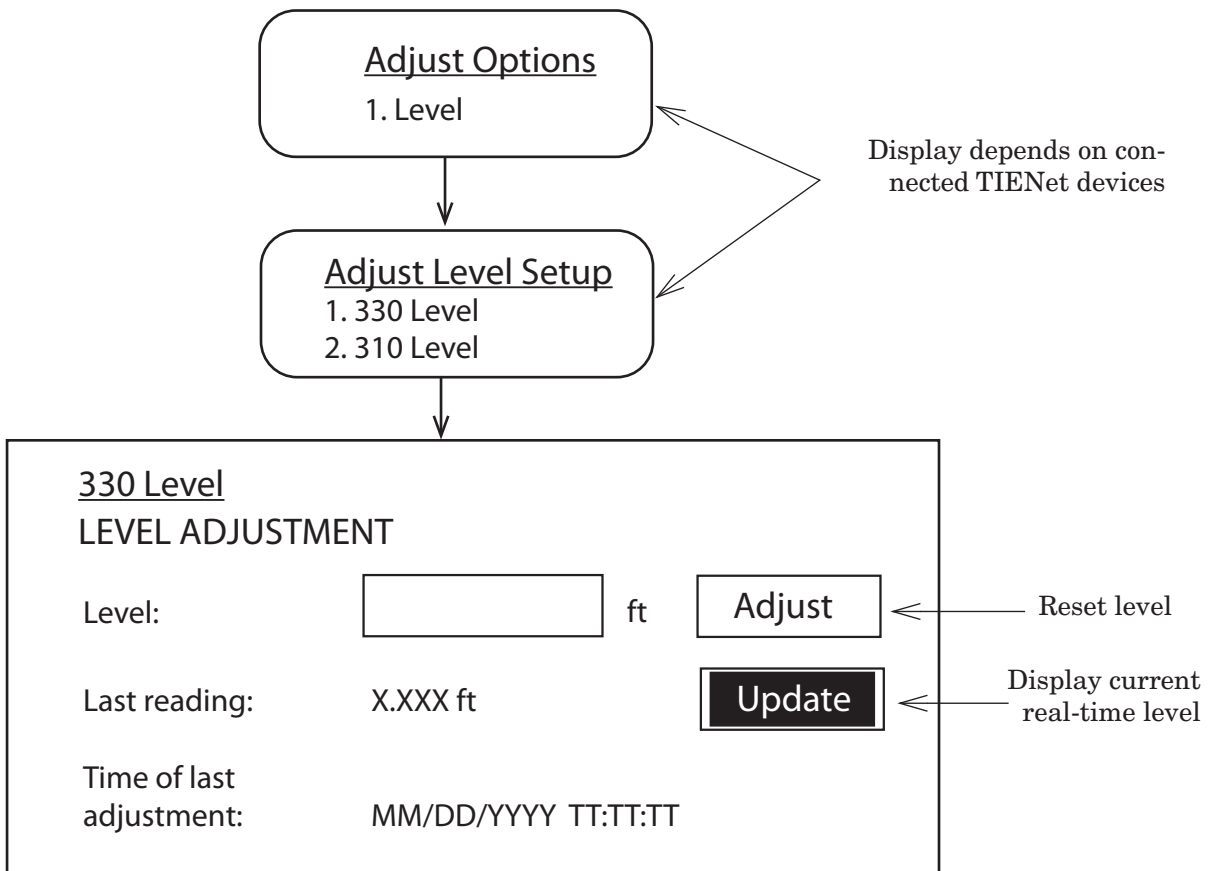


Figure 3-16 Level adjustment

3.8 TIENet Sensor Installation in a Hazardous Location

In applications where the TIENet sensor will operate within a hazardous area, the installation must be performed by trained and qualified personnel, according to the installation control drawing provided in Figure 3-17, and in accordance with local requirements.

Information about hazloc installation specific to the TIENet 310 Ultrasonic Level Sensor is provided in the sensor’s user manual.

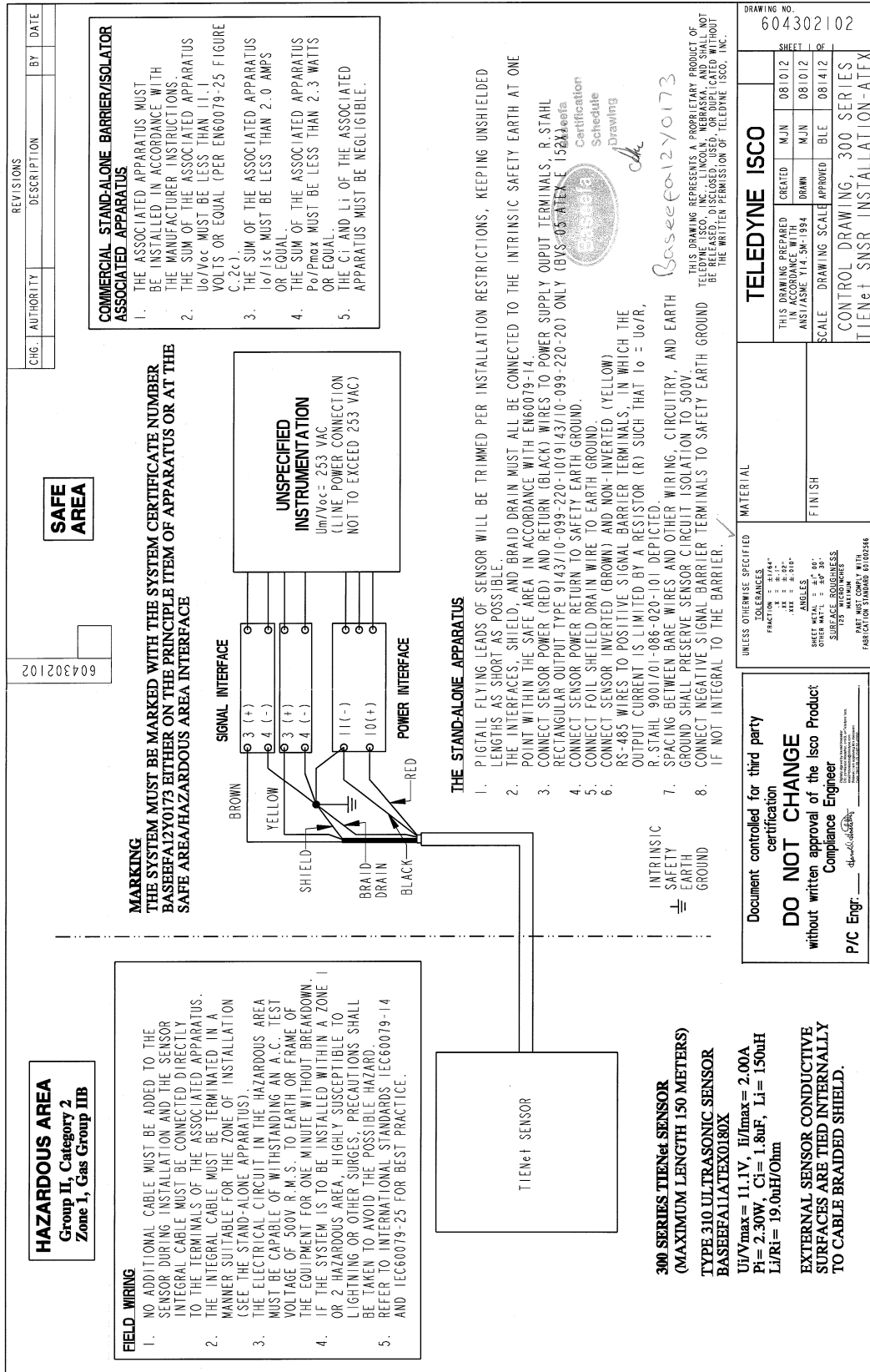


Figure 3-17 Hazardous Location Installation Control Drawing-ATEX

Signature® Flow Meter

Section 4 Portable Installation

This section contains physical preparation procedures and portable mounting methods for the Signature Flow Meter and associated Teledyne Isco equipment. Section 3 will contain the permanent installation information for the Signature Flow Meter.

4.1 Introduction

The Signature Portable is equipped with one TIENet® receptacle. In the event a connection must be made directly to the board refer to the permanent Signature installation connection to external devices in Section 3.2.

Where additional TIENet devices are deployed with a Signature Portable, there is an optional TIENet 'Y' connection cable available to expand the number of connections as needed. See Appendix B for ordering information.

4.2 Portable Stand

The portable stand allows the user to move the Signature to various locations and without a permanent installation. This Signature has multiple power options and can be in either in an upward facing or side facing position (Figure 4-1). The Signature Portable is shipped from the factory in a side facing position.



Figure 4-1 Signature on portable stand side facing (left) and upward facing (right)

Tools

#2 Phillips screw driver

4.2.1 Adjust Signature to Upward Position

To adjust the Signature to be in the upward facing position:

1. Move the handle into the down position by pulling out the handle latch pins on each side of the stand (Figure 4-2)



Figure 4-2 Pull out the handle latch pins on each side of the stand

2. Loosen all of the screws in the top of the stand (2 panhead and 2 flathead per side) with a #2 Phillips screw driver. (Figure 4-3). These screws are captivated, so loosen until they stop turning.



Figure 4-3 One of the eight screws loosened.

3. Once the four flathead screws are loosened, rotate the meter toward the back and lift straight up to remove it from the stand (Figure 4-4).

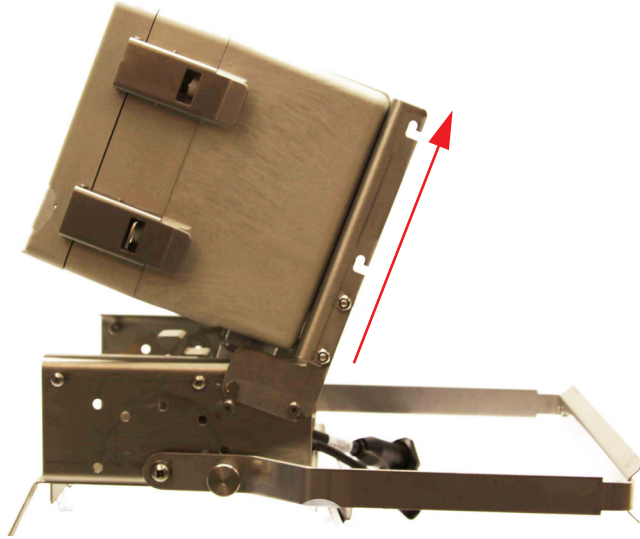


Figure 4-4 Signature tilted up in preparation of removal

4. Align the notches in the Signature mount with the pan-head screws on the stand.
5. Engage the slots and push the meter toward the back until it stops.
6. Tighten all 8 screws (4 on each side) (Figure 4-5).

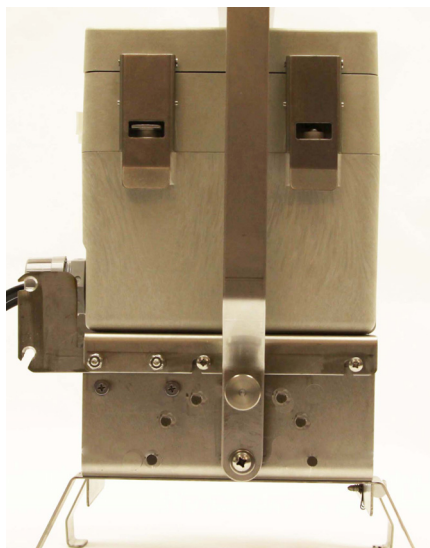


Figure 4-5 Signature in upward facing position

4.3 Power

The Signature Portable is designed to be used with 12 VDC lead acid batteries.

4.3.1 Power Connections

The standard battery connection on a Signature Portable accepts Teledyne Isco model 948 or 946 lead acid batteries.

Adapting cables can be purchased to connect to a customer supplied deep cycle marine battery.

WARNING

Do not set the portable stand directly on the terminals of a battery. Serious injury or permanent damage may occur.

External Power Connection

The External Power connection is for user supplied DC power. Figure 4-11 (below) shows the connector in the case bottom circuit board P9 Pins 1 and 2 of the “Lead Acid Battery” connector are used. Pin 1 is “Ext Pwr” and pin 2 is Ground. A minimum of 18 gauge wire is required. This input is intended for Solar power installations both 12 and 24VDC or 24VDC DIN power. 24V solar power systems can reach 35VDC during the “Rejuvenation” cycle. The recommended voltage input is 10 to 28.5VDC nominal. Above 36VDC the 4 amp fuse will open to protect the circuit. For one time use batteries, this input will function down to 4VDC. User must provide protection against discharging rechargeable batteries too far. Follow the Solar Panel installation guide for proper connections. Ensure that the frame of the solar panel is properly tied to Earth ground so the electrostatic discharge is controlled.

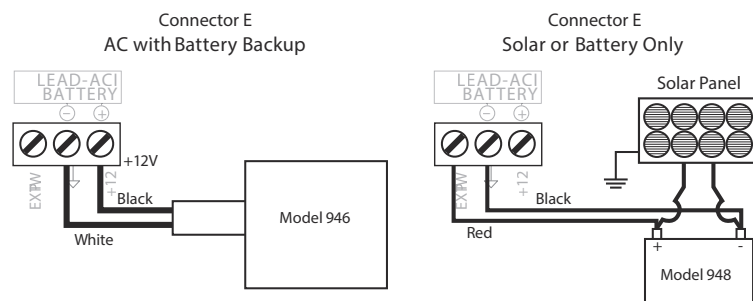


Figure 4-6 Connector E diagram

4.3.2 Outdoor Recommendations

The Signature Portable can be mounted to the portable stand in a side facing or upward facing position (Figure 4-1).

When the Signature Portable is used in an unprotected environment it is recommended the screen is in the side facing position so it does not collect water.

4.3.3 Battery Installation

Common battery options for the Signature Portable:

- 946 lead-acid battery
- 948 lead-acid battery
- Lead-acid battery with solar panel

948 lead-acid battery

When using the 948 lead-acid battery the portable stand will sit directly on top of the battery case, where the battery is enclosed. There is a notch in the back of the portable stand that will fit over the power cable from the Signature to the battery. (Figure 4-7).

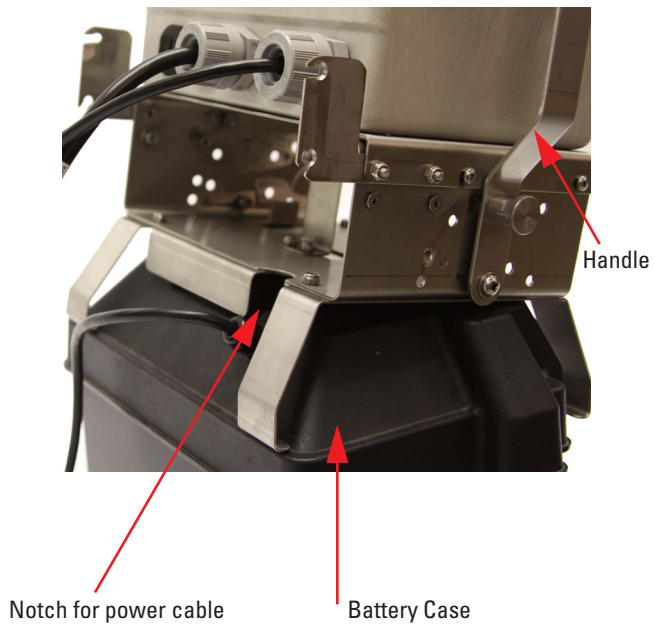


Figure 4-7 Notch in stand for the power cable

When using the 946 lead-acid battery, this battery will fit directly under the Signature inside of the portable stand (Figure 4-8).

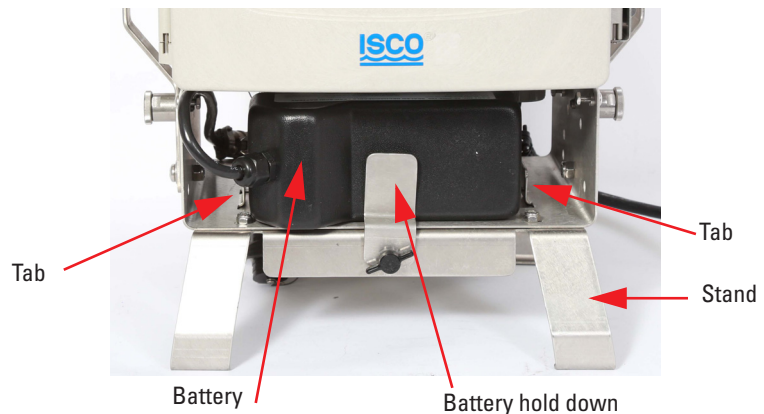


Figure 4-8 946 lead-acid battery installed under the Signature Portable

946 lead acid battery

To install the 946 lead-acid battery:

1. Remove the battery hold down of the portable stand by loosening the thumb screw.
2. Thread the power cable through to the left side of the portable stand and slide the battery in, between the metal tabs, after it. The battery will fit snugly.
3. Replace the battery hold down and tighten the thumb screw.
4. Plug the cable into the Signatures power connector.

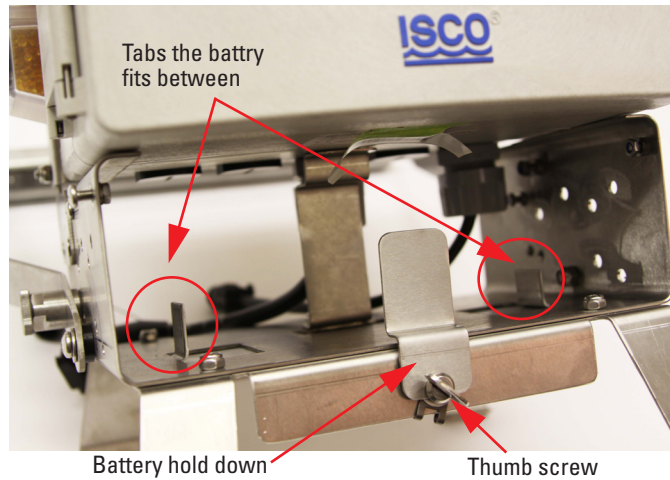


Figure 4-9 Battery hold down and thumb screw

4.4 Battery Life Expectancy

This section will cover the average battery life as related to the most common applications. For more information about battery life please consult the factory.

CAUTION

The following section on battery life is for information purposes only and does not constitute a guarantee of service or warranty of any kind.

4.4.1 Major Standard Equipment Settings Effecting Battery Life

Display backlight and power

When the front screen is powered off the Signature is no longer taking near continuous readings. The reading interval will be based on the data storage rate and any actively used equations.

Data storage rate

Many options effect the storage rate as related to battery life, see. See 2.7.5 Data storage for a complete explanation.

Equations

Equations used by alarms, triggers, or secondary measurements can effect the battery life of the equipment. The minimum measurement setup in the equation should be the data storage interval used for battery calculations.

For example, the data storage rate is set to 15 minutes, an equation is set with a measurement interval of 5 minutes. For battery life calculations it would be more accurate to use the battery life expectancy of 5 minutes.

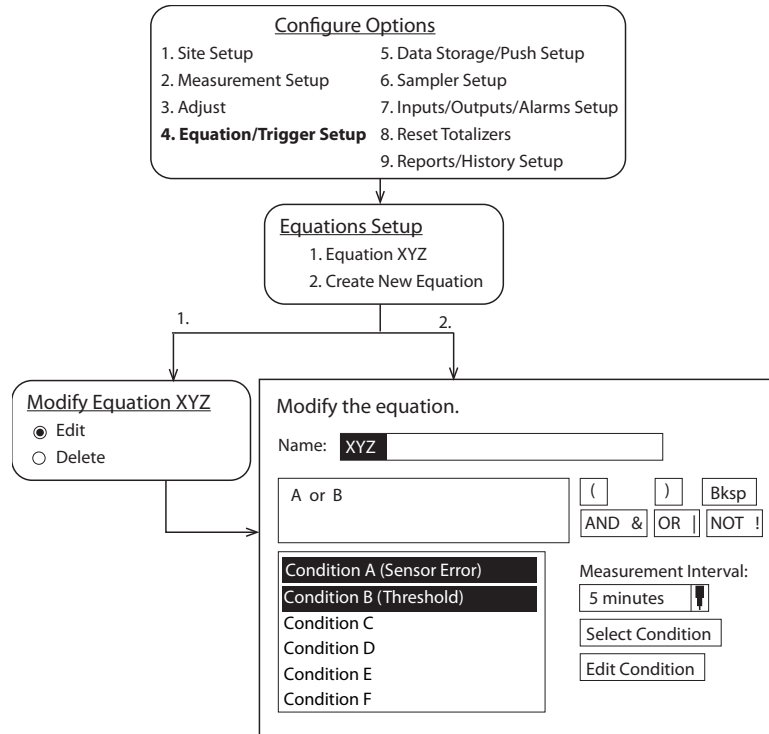


Figure 4-10 Example of defining conditions and building equations

4.4.2 Major Optional Equipment Settings Effecting battery Life

Cell Modem

The longer the call window is open the more it will drain battery.

LaserFlow

The LaserFlow has additional battery life considerations. Please see the Laser 360 manual for more information

Analog Output Card

The analog output card is not a typical component on a battery operated device. The current draw over time is great and hard to predict.

Ethernet Card

With a very high average current, the ethernet card is not recommended for most applications using batteries.

Bubbler

Bubbler purges draw a large amount of current. Lengthen the Purge Interval for improved battery life.

4.4.3 Additional Considerations for Battery Life

Bubbler Tubing

The longer the bubbler and sensor line the more current draw the meter will have. In most cases the difference in current draw will not be a factor, but exceptionally long lengths will be a factor.

Reading Retries

If the sensor is in a location where reading errors occur, the unit will attempt to retry until a good reading is taken.

Battery Capacity

If the battery is damaged (decreased battery capacity) the Signature will not run as long as the charts and calculations in this section suggest. Batteries loose capacity:

- as they age
- as temperatures decreases
- when stored
- discharged below default or recommended levels

Table 4-1 Battery Life Expectancy (default measurement rate of 15 minutes)				
	Ultra Sonic	LaserFlow	A/V	Bubbler
Average current draw in ma	65	68	68	67
Model 946 lead-acid battery, 12 vCD, 6.5 amp-hours	100 hours	96 hours	96 hours	97 hours
Model 948 lead-acid battery, rechargeable, 12 vCD, 45 amp-hours	692 hours	662 hours	662 hours	672 hours

Table 4-2 Battery Life Expectancy (measurement rate of 5 minutes, all other parameters use default)				
	Ultra Sonic	LaserFlow	A/V	Bubbler
Average current draw in ma	65	70	69	67
Model 946 lead-acid battery, 12 vCD, 6.5 amp-hours	100 hours	93 hours	94 hours	97 hours
Model 948 lead-acid battery, rechargeable, 12 vCD, 45 amp-hours	692 hours	643 hours	652 hours	672 hours

Table 4-3 Default Method for Portable Signature

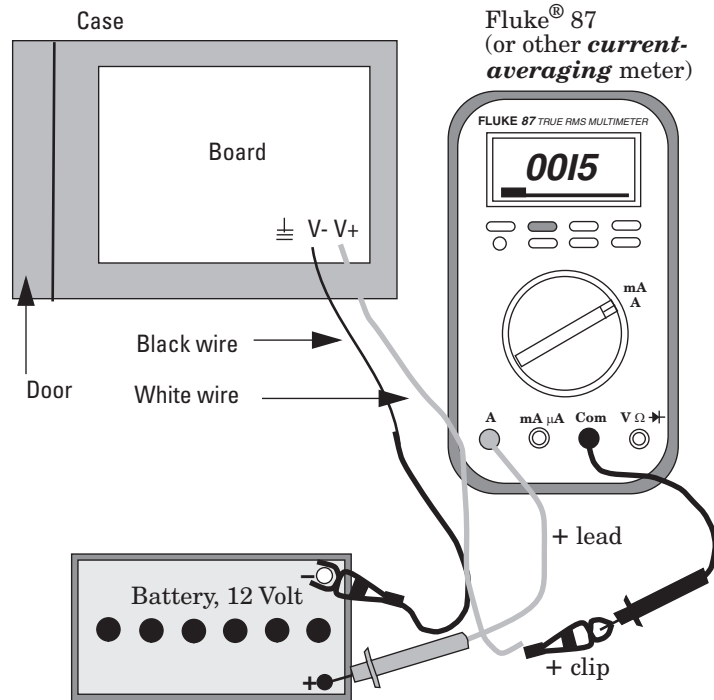
Setting	Duration/Setting
Laser (if present)	Single point measurement
Optical clarity (if laser used)	enabled (but not active)
Bubbler purge (if bubbler is present)	4 hours
Measurement Rate	15 minutes (for all flow technologies)
Backlight	Key press time-out (30 second timeout enabled)
Display shutoff	Key press time-out (5 minute timeout enabled)
Cellular Modem call Window (if modem is present)	Open daily for 1hr
Equations used by alarms, triggers. Secondary Data storage rate	None set
If present during a TIENet scan the Signature will configure flow technologies, modem and laser as shown in the chart above. If none are present the options will not be configured and will not affect power settings.	

Table 4-4 Additional Average Current Draw

Purge interval 15min (if bubbler is present)	7
Backlight always on, display always on	48
301 PH sensor (15min data storage interval)	27
306 Sampler interface assuming	No significant increase
307 Analog input card (active)	45
307 Analog input card (passive)	No significant increase
304 Contact Output	10
Totalizer 1000 count per hour	No significant increase
Ethernet communication module	88

4.4.4 Calculating Average Current Draw

If the conditions listed in the average battery life tables and default method do not match your application, you can use the following procedure to calculate the current draw.



A good quality, adjustable, regulated DC power supply can be substituted for the 12-volt battery. The power supply should have at least 3 Amperes output, preferably more, and capable of overcurrent surges.

Figure 4-11 Measuring flow meter current

Note

Do not attempt this procedure unless you have the proper equipment available and know how to make electrical measurements.

Many of the power using functions in the Signature vary over time. To measure current for a varying load requires a more-sophisticated type of multimeter, one that is capable of averaging high and low readings over a period of time. The Fluke® 87 Multimeter is one example of this type of meter.

You should set the meter on MIN/MAX and let it run with your program for several hours or more. Other manufacturers' meters are also acceptable, but only if they are capable of averaging current draw. The current test should be run long enough to capture all periodic usage. The longer you run the test, the more accurate the average will be.

4.4.5 Battery Life Calculations

To calculate battery life expectancy for an installation, you must know two things:

- The capacity of the battery you are using
- The average current draw of the flow meter or (other device) powered

Battery capacity is expressed in ampere-hours. The battery manufacturer provides this information for each battery. This value is the product of a load current times an arbitrary time period, twenty hours for lead-acid types. Isco 946 batteries lead acid batteries are rated for 6.5 ampere-hours.

To determine battery life for a Signature running on a 946 lead acid battery, convert the battery capacity into milliamperes/hours and then divide the ma/hrs by the avg current draw. This will give you a number in hours. Divide that figure by 24, and you will have the number of days.

 **Note**

The published ampere-hour figures do not mean that you can expect to draw 6.5 amperes from the lead-acid battery for one hour.

Examples

To convert ampere-hours to milliamperes, multiply by 1,000.

$$6.5 \text{ ampere-hours} \times 1,000 = 6,500 \text{ mAh}$$

If you divide this figure by the average current of the flow meter, say 65 mA, you will have:

$$6,500 \div 65 = 100 \text{ hours}$$

Divide this number by twenty-four to get days:

$$100 \text{ hours} \div 24 = 4.1 \text{ days}$$

For considerations of safety, we suggest you subtract 10% from this number (100% – 5% for 95% capacity and 5% for a reserve at the end of discharge).

$$4.1 - .4 = 3.7 \text{ days}$$

The 3.7 days is the battery expectancy for a lead-acid battery with a 65 mA continuous average drain, with a 10% derating factor. Remember if the battery fails there will be a period of time during which no measurements will be taken and no data stored (if you are also using Flowlink® software).

 **Note**

Always operate these batteries with a reserve factor.

4.4.6 Low Battery Cut Off and Battery Care

Batteries are considered fully discharged well before the terminal voltage drops to zero volts. Operating lead acid batteries below the fully discharged point decreases their capacity and damages the battery. Lead acid batteries, under a constant rate of discharge, are considered fully discharged at 11.5 volts, however; the Signature does not discharge the batteries at a constant rate.

Time durations will allow you to get the maximum amount of life and readings out of the battery without damaging it. It can also prevent a short term power dip from causing a premature shutdown. By default, the Signature will turn itself off when the battery voltage is at 11.5v for 2 min. To prevent the unit from cycling OFF and ON the unit will not recover (turn back ON) until the battery voltage is 13.0 for 2 minutes.

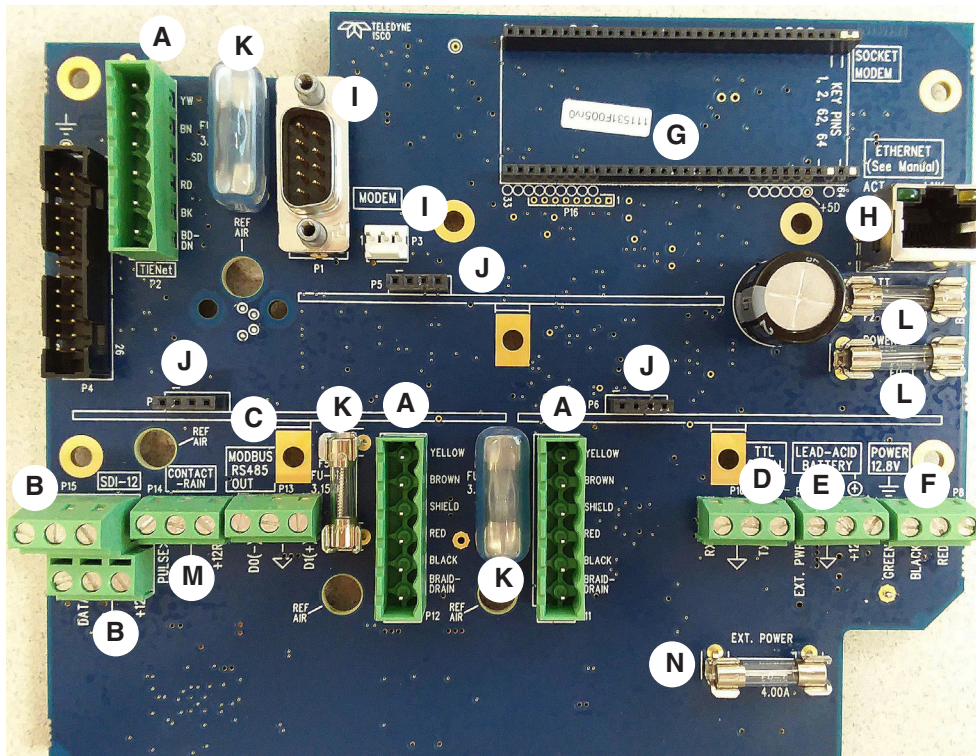
WARNING

Adjusting the low battery cutoff improperly will damage the batteries. Teledyne Isco assumes no liability for damage done to Teledyne Isco or third party vendors batteries. Adjust the low battery cut off at your own risk. User assumes all liability for damage done to batteries by altering the low battery cut off.

Using disposable batteries may allow for greater flexibility and possible usage. The low battery cutoff point can be adjusted by the user. The duration the battery must remain at this voltage for shutdown to occur is fixed at 5 min. If the low battery cut off is altered it must remain at the adjusted level for 5 min before the unit will shut down. Altering the low battery cutoff does not alter the recovery settings. No matter what the low battery cutoff is set to the unit will not recover or turn back on until the battery voltage is at 13.0 for 2min.

4.5 Connect to External Devices

Connection to TIENet socket.



Note: No 12.8 VDC power supply for Signature Portable Flow Meter

	External TIENet Devices/
A	Modbus RS485 In D1 = Yellow (+) D0 = Brown (-) Gnd = Black
B	SDI-12 Input
C	Modbus RS485 Out
D	TTL Serial
E	Battery Backup/ Battery for Portable Ext Pwr input
F	12.8 VDC
G	Ethernet Modem
H	Ethernet Port
I	Cellular Modem (power & serial)
J	4-20mA Input/Out- put Card and Contact Output Card
K	Fuse "T" 3.15A
L	Fuse "T" 4.00A
M	Rain Gauge
N	Fuse "T" 4.00A

Figure 4-12 Connector case, connectors, and fuses for Signature Portable Flow Meter

4.5.1 Connecting Devices to the TIENet Receptacle

The optional external TIENet devices compatible with the Signature Portable all scan in the hardware in the same manner. Multiple TIENet devices can be connected simultaneously to the same Signature Flow Meter. The following TIENet smart sensors/cables will attach to the TIENet receptacle:

- Ultrasonic Level Sensor
- Area Velocity Sensor
- Bubbler
- pH/Temperature
- LaserFlow
- Sampler

Connecting a TIENet receptacle to the Signature Portable

To connect the TIENet plug from the sensor to the TIENet Receptacle:

1. Align the connectors and push together (Figure 4-13).
2. After the physical connection is made, a scan must be performed (see section 2.6.1) for the device to be recognized.

For additional TIENet connections, use the TIENet Y-cable or alternately an expansion box.

1. Coat the O-ring's sealing surface with a silicone lubricant.

O-Ring and Lubrication for the TIENet receptacle

CAUTION

Do not use petroleum-based lubricants. Petroleum-based lubricants will cause the O-ring to swell and eventually deteriorate. Aerosol silicone lubricant sprays often use petroleum-based propellents. If you are using an aerosol spray, allow a few minutes for the propellant to evaporate before proceeding.

2. Align and insert the connector. The sensor release will “click” when the sensor connector is fully seated.
3. Connect the two caps together.



Figure 4-13 How to connect a TIENet receptacle to the Signature Portable

Three-Hole Cord Grip

The following device wires/cables are normally connected thru the 3-hole cord grip:

- Rain Gauge
- SDI-12
- Modbus output

The wire/cable diameter can be .200 in to .230 in.

Installing a Cable Through a Three-Hole Cord Grip

1. Remove plug to open hole for an additional cable.

Note

Gland nut must be loose to remove this plug.

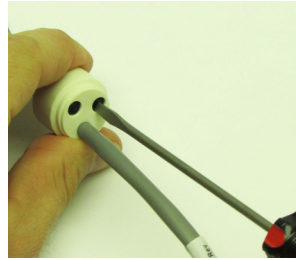
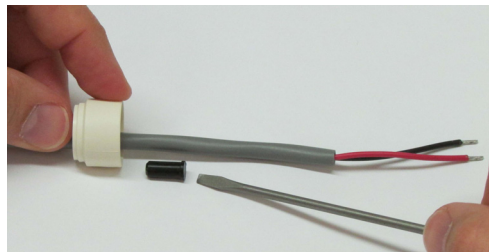


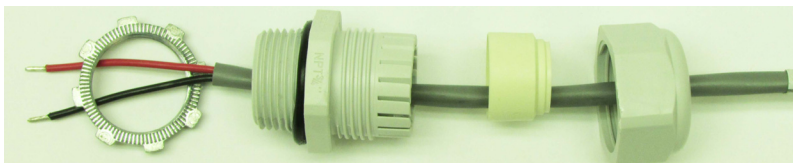
Figure 4-14 Removing the plug

Note

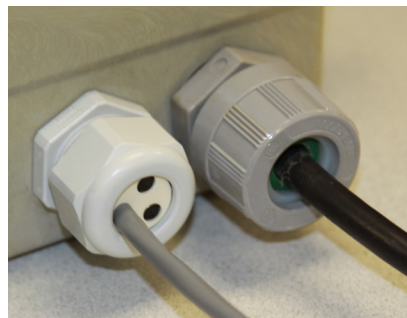
When replacing the plug, the rounded side needs to be pushed into the hole, with the flange facing out (see figure below).



2. Thread the cable through the open hole and various connectors.



3. Connect the three-hole cord grip to the Signature.



4. Attach the three-hole cord grip to the Signature port and attach the wires to the appropriate screw terminals.

CAUTION

Drilling holes in the Signature cases is not recommended and may result in water damage. The material of the Signature case is constructed of Noryl and does not lend itself to post molding alterations.

Connecting the Rain Gauge

The following shows how to connect the rain gauge to the Signature Portable and how the cables should look when properly connected (Figure 4-15).

1. Remove the rain gauge cap and connect it to the TIENet receptacle.

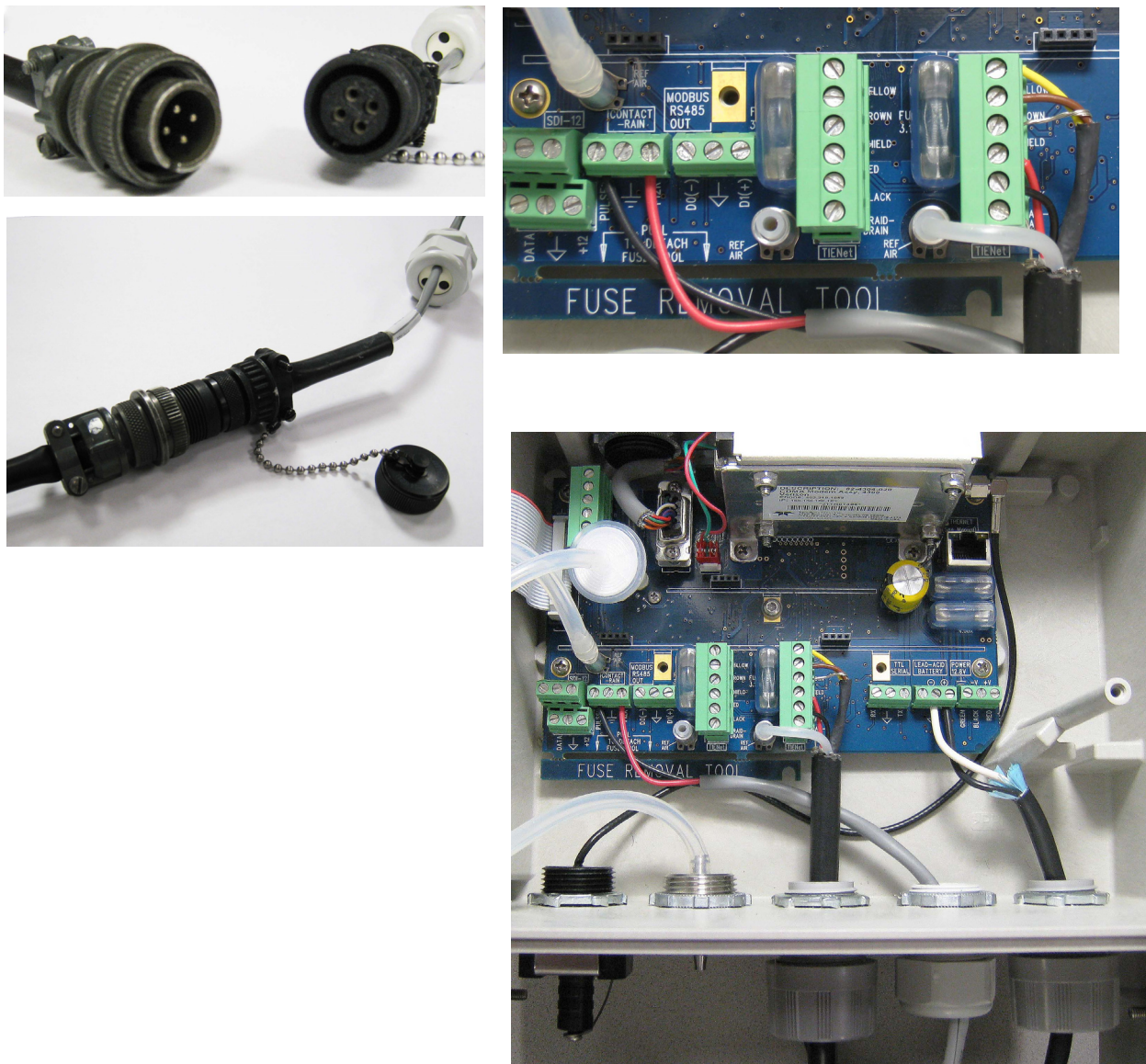


Figure 4-15 Connecting a rain gauge to the Signature receptacle (L) and then to the Signature connector board (R)

Signature® Flow Meter

Section 5 Equipment Options

Optional equipment is designed to be user-installable. Internal options, when ordered at time of purchase, are installed in the Signature meter at the factory. This section describes each option and provides instructions for its installation and operation.

All optional cable entries must use appropriate ID conduit connections or cord-grip fittings to retain the IP66 rating. If you are using non-TIENet or non-Signature cables, you must supply the appropriate ID conduit connections or cord-grip fittings.

Note

Installation and operation of exterior TIENet devices is covered in detail in the user manual for that technology.

Many options require interior access for installation. For connector case interior access and TIENet device wiring instructions, refer to *Connecting External Devices*, on page 3-1 and *Connecting TIENet Devices*, on page 3-7.

DANGER

Before opening the case, first ensure that mains power is disconnected from the unit and any battery power is disconnected.

Part numbers for ordering accessories are provided in Appendix B *Options and Accessories*. Optional equipment from Teledyne Isco includes:

AC Power Cord Kit /AC Wiring (Applies to Permanent Installation Only), on page 5-2

Battery Backup (Applies to Permanent Installation Only), on page 5-4

Mechanical Totalizer, on page 5-8

External Desiccator, on page 5-11

Ultrasonic Level Sensor, on page 5-12

Bubbler Level Sensor, on page 5-13 and 6-17

Contact Output Card (TIENet 304), on page 5-16

Analog Input Card (TIENet 307), on page 5-21

Analog Output Card (TIENet 308), on page 5-25

pH and Temperature Device, on page 5-15

Sampler Interface, on page 5-14

pH and Temperature Device, on page 5-15

Sampler Interface, on page 5-14

TIENet Expansion Box, on page 5-15

Isco Flowlink Software, on page 5-29

Ethernet Modem, on page 5-29

Cellular Modems, on page 5-34

Laser Doppler Velocity Sensor, on page 5-13

Continuous Wave Doppler Velocity Sensor, on page 5-13

5.1 AC Power Cord Kit /AC Wiring (Applies to Permanent Installation Only)

The AC power cord kit includes a line cord with a strain relief cord-grip fitting. If ordered with the Signature Flow Meter, it will be shipped from the factory already installed.

Instructions for user installation are provided in this section. **Note that these instructions can also be used as guidance for user-supplied or replacement line cord, hard wiring, or replacement power supply.**

Open the flow meter housing, following all warnings and instructions provided in *Connecting External Devices*, on page 3-1.

1. *If a cord-grip fitting is already installed*, loosen the sealing nut on the AC line cord. *If conduit is installed*, remove the sealing material around the AC line cord where it enters the housing. This is to free the cabling for movement or removal.

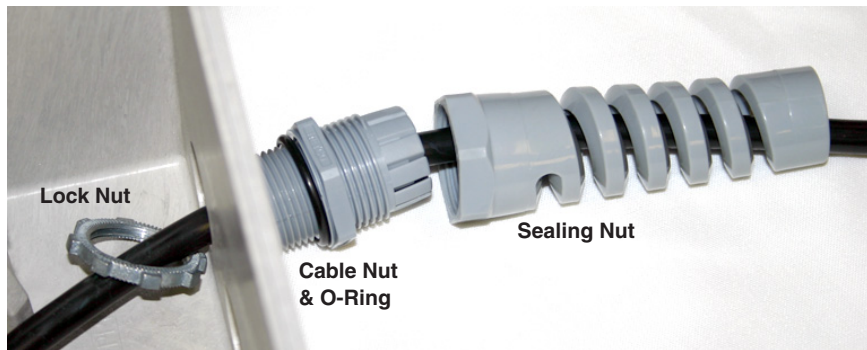


Figure 5-1 AC Line cord with a cord-grip fitting

2. Remove the mounting screw and lift the power supply out of its molded niche, taking care not to strain the wires going to the board.

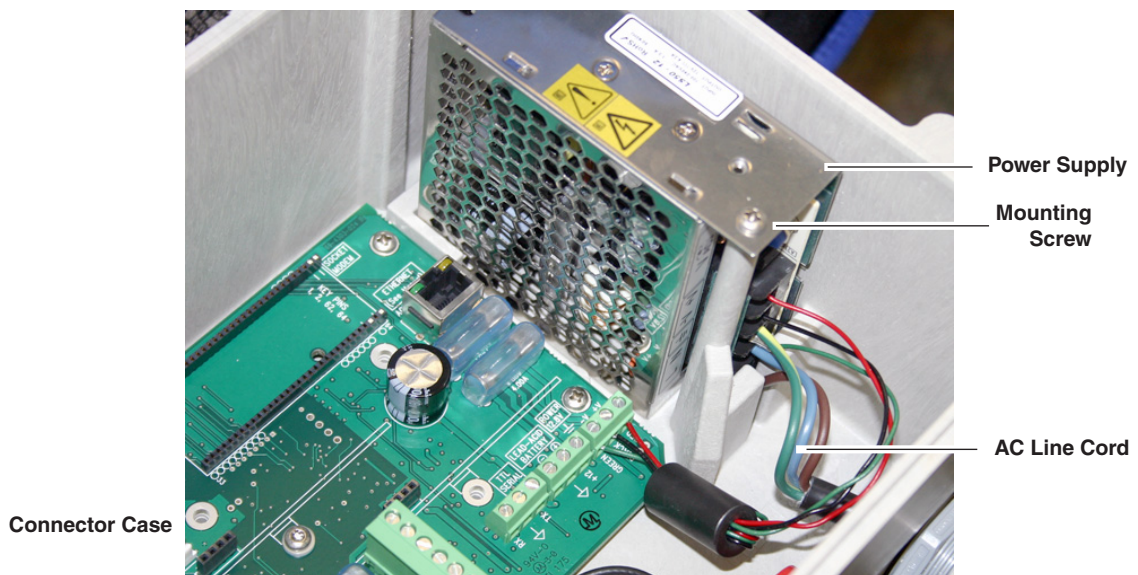


Figure 5-2 Power supply mounting screw

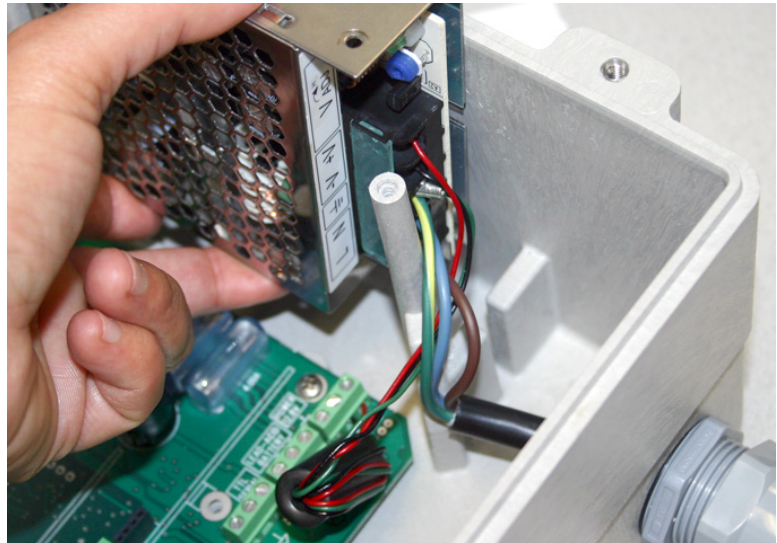


Figure 5-3 Power supply removal/replacement

3. Remove the clear plastic shield protecting the power supply terminals (Figure 5-4). Note that the Signature ground wire ends in a ring terminal so the line cord ground wire can easily be connected to the same terminal.
4. If replacing the power supply, label all wires according to their terminal connections (i.e., **L**, **N/L**, **Gnd**, **-V**, **+V**), and disconnect them.

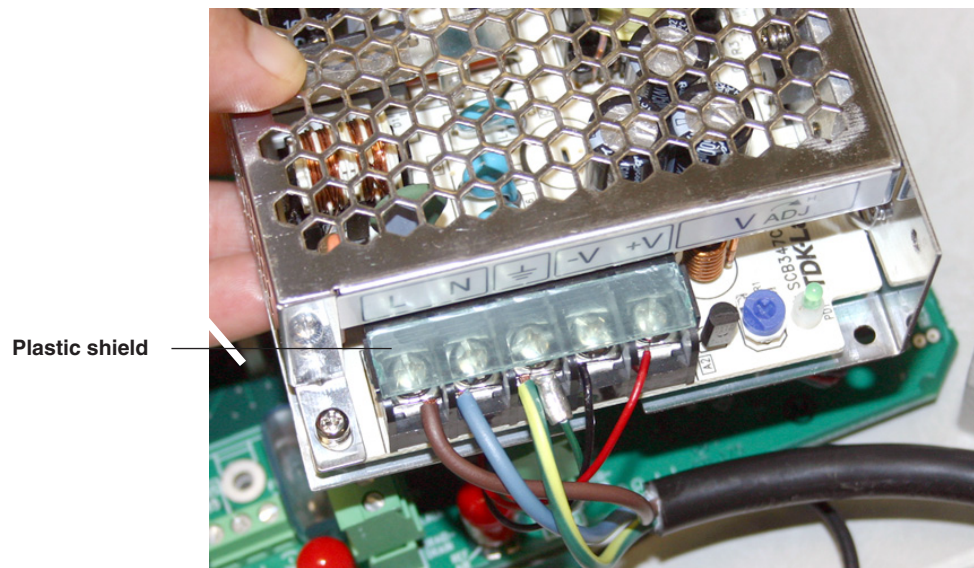


Figure 5-4 Power supply terminal strip: AC Input and DC Output

5. *If installing a cord-grip fitting (refer to Figure 5-1):*
 - a. Remove the lock nut from the cable nut.
 - b. Install the cable nut through the line cord cable entry (closest to power supply location) in the bottom of the connector case and secure it to the Signature case wall with the lock nut.
 - c. Feed the line cord end through the sealing nut and then through the cable nut, into the case.
 - d. Lightly tighten the sealing nut, just enough to hold the line cord in place while connecting it to the power supply.
6. Connect the line cord wires to the power supply, as shown in Figure 5-4, and then reinstall the plastic protective shield.

Note

Double-check to ensure that the terminals labeled **Gnd**, **-V**, and **+V** on the Signature circuit board are wired to their corresponding terminals on the power supply.

7. Reinstall the plastic shield over the wiring connections.
8. When seating the power supply into its niche, guide the attached wires around in front of the mounting standoff and through the molded slot, so they are not strained or damaged (see Figure 5-3).
9. *If using a line cord*, gently tug the line cord to remove any slack within the enclosure, taking care not to stress the connection, and tighten the cord grip sealing nut.

CAUTION

If you are using conduit instead of the cord-grip fitting, the conduit and wires in the conduit **must be sealed** to prevent harmful gases and moisture from entering the Signature enclosure. Failure to seal conduit could reduce equipment life.

10. Close the front panel and fasten it shut with the two Phillips screws.

5.2 Battery Backup (Applies to Permanent Installation Only)

The battery backup option consists of a Teledyne Isco Model 946 lead-acid battery pack and extension cable, with special hardware to mount it on the top of the Signature Flow Meter, or on a wall. The unterminated power cable normally enters the connector case through the second port from the right.

Note

An optional external power loss alarm is available. See Section 5.3 *Power Loss Alarm*.

DANGER

Before opening the case, first ensure that mains power is disconnected from the unit.

CAUTION

Before opening the case, disconnect the optional battery backup power, if used.

CAUTION

Do not substitute another battery type for this option. Use only the Model 946 Lead-Acid battery.

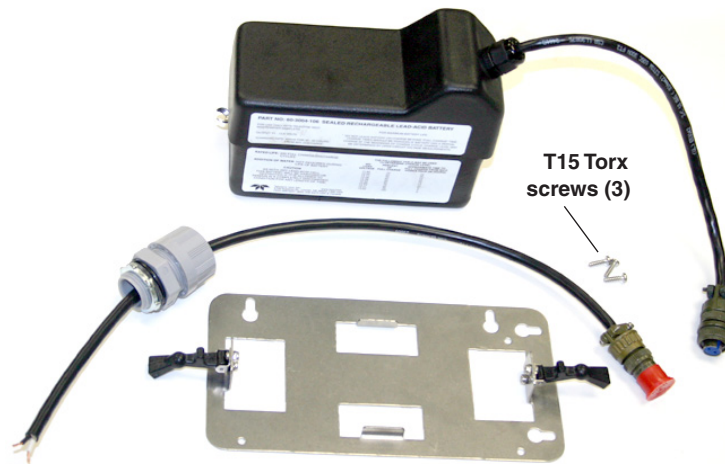


Figure 5-5 Battery backup kit contents

CAUTION

If you are using conduit instead of the cord-grip fitting, the conduit and wires must be sealed to prevent harmful gases and moisture from entering the Signature enclosure. Failure to seal conduit could reduce equipment life.

Installation

1. Remove line power from the Signature Flow Meter and open the case as previously described in Section 3.2.

CAUTION

Do not connect the extension cable to the battery cable until all other steps are completed.

2. At the LEAD-ACID BATTERY terminal strip, connect the extension cable's black wire to the +12 terminal, and the white wire to the ground terminal.

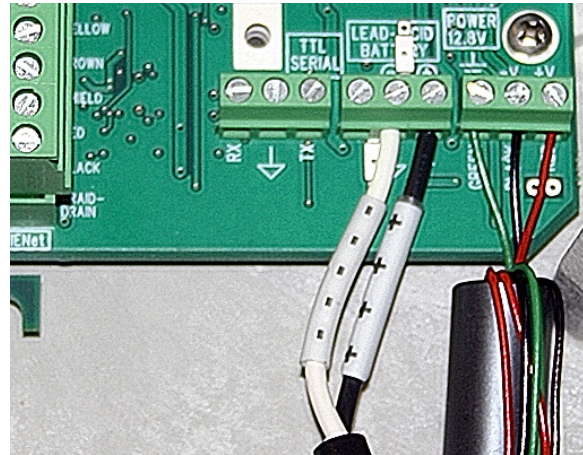


Figure 5-6 Attach extension cable to the connector case

3. Install the mounting plate, either on top of the flow meter case using the Torx screws provided, or on the wall nearby.

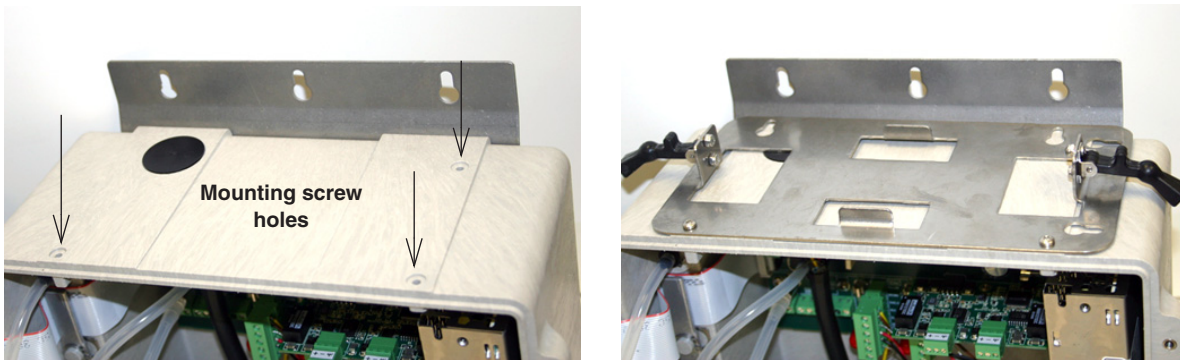


Figure 5-7 Installing the battery backup mounting plate

4. Place the 946 battery on the mounting plate and secure it in place using the two black rubber draw catches.
5. Connect the battery cable to the extension cable.



Figure 5-8 Backup battery, installed

Note

Be sure to unplug the battery when intentionally disconnecting from AC power.

5.3 Power Loss Alarm

*Contact Output Card
(TIENet 304)*

The Signature Flow Meter offers different options to notify you of line power loss.

The Contact Output Card is an optional card that closes or opens relays at specific thresholds set within the Signature Flow Meter programming. For power loss indication, it is recommended to configure the Signature to activate the contact output to CLOSE when the 300 Sense Voltage drops below 12 VDC. The output relay will deactivate when the 300 Sense Voltage drops below 12 VDC or if the power drops all together.

*Analog Output Card
(TIENet 308)*

The Analog Output Card provides an analog output signal proportional to a configured measurement input. For power loss indication, it is recommended to configure the Signature so the analog output is proportional to the 300 Sense Voltage. The external device monitoring the analog output should alarm when the analog signal drops below the equivalent of 12 VDC reported by 300 Sense Voltage.

12 Volt DC Output

The Signature system operates on 12 VDC. A voltage level of 12 VDC at the POWER 12.8V terminal (Figure 5-6) will indicate adequate power supplied to the Signature meter, whereas a voltage level of less than 12 VDC will indicate a power loss.

*Signature Power Loss
Alarm Box (60-5324-024)*

This device energizes a relay based on the Signature operating voltage of 12 VDC. When the 12 VDC supply drops below 9 VDC the relay becomes de-energized and switches the relay contact indicating a power loss. It has NORMALLY OPEN and NORMALLY CLOSED outputs.

5.4 Mechanical Totalizer

The mechanical totalizer is a seven-digit, non-resettable mechanical counter installed in the front panel. It increments according to programmed totalizer resolution and units of measure. The totalizer can be viewed once the metal shield or bubbler module is removed.

The volume represented by the mechanical totalizer is always the primary Total Flow programmed in Measurement Setup > Volume Input Setup (refer to *Configure Options*, on page 2-20).

The mechanical totalizer increments with the **third significant digit** of the selected resolution (see Figure 2-15 *Menu Tree: Volume Input Setup (total flow)*), e.g.:

Resolution 999999999 = Increment every 100 units;

Resolution 99999999.9 = Increment every 10 units;

Resolution 9999999.99 = Increment every 1 unit, etc.

The Signature permits a maximum 300 counts per minute; if totalized flow exceeds this rate, remaining volume will be buffered until it can be counted, although buffering over extended time periods is not recommended.

Installation

1. Remove line power from the Signature Flow Meter and open the case as previously described in Section 3.2.
2. Remove the four mounting screws holding the metal shield in place and set it aside.
3. Using a razor blade or utility knife, carefully cut the six tabs in the control panel label to detach the totalizer window cover.

 Note

Be sure to cut all six tabs. Pulling on the cover with some of the tabs still attached will damage the control panel label.

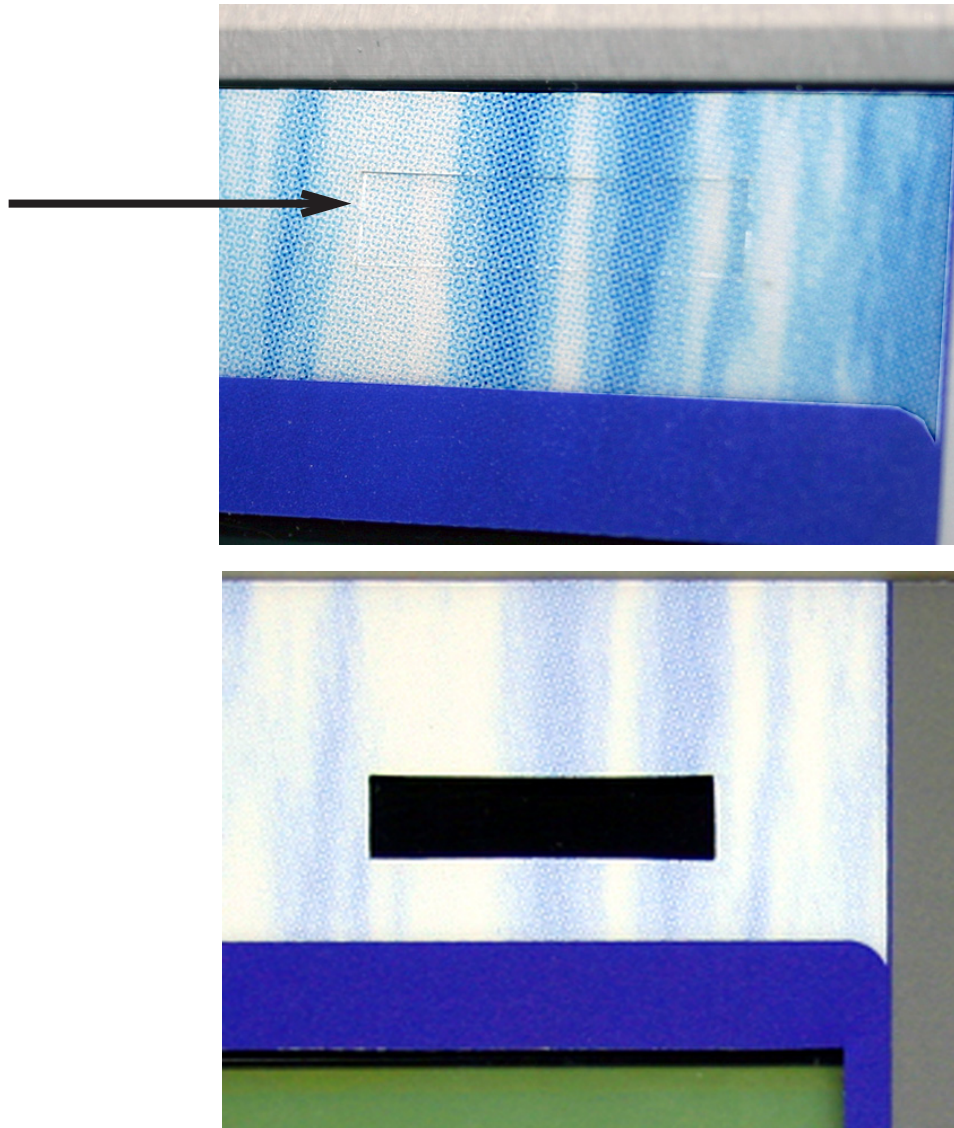


Figure 5-9 Remove totalizer window cover

Referring to Figure 5-10:

4. Remove the two screws above the totalizer cutout provided in the Main CBA. These screws will be used for mounting the totalizer.
5. Install the totalizer in the cutout, attaching the two mounting tabs with the two screws, so that the numbers appear in the window.
View the totalizer through the window and adjust the position, if necessary, before tightening the screws.
6. Plug the totalizer connector into **P10** on the Main CBA. This two pin connector is keyed to prevent incorrect attachment.



Figure 5-10 Optional non-resettable totalizer installation

5.5 External Desiccator

For Signature systems using the 330 or 360 Bubbler Module and/or the TIENet 350 Area Velocity Sensor, the desiccator vents the reference port for a pressure transducer, and the air intake port for the bubbler system air pump, keeping the interior of the flow meter case dry, as well as the sensor reference line.

Note

The desiccant is standard on the portable version of the 330, 350, and 360 Bubbler module. It is not standard on the non-portable 310 Bubbler module.

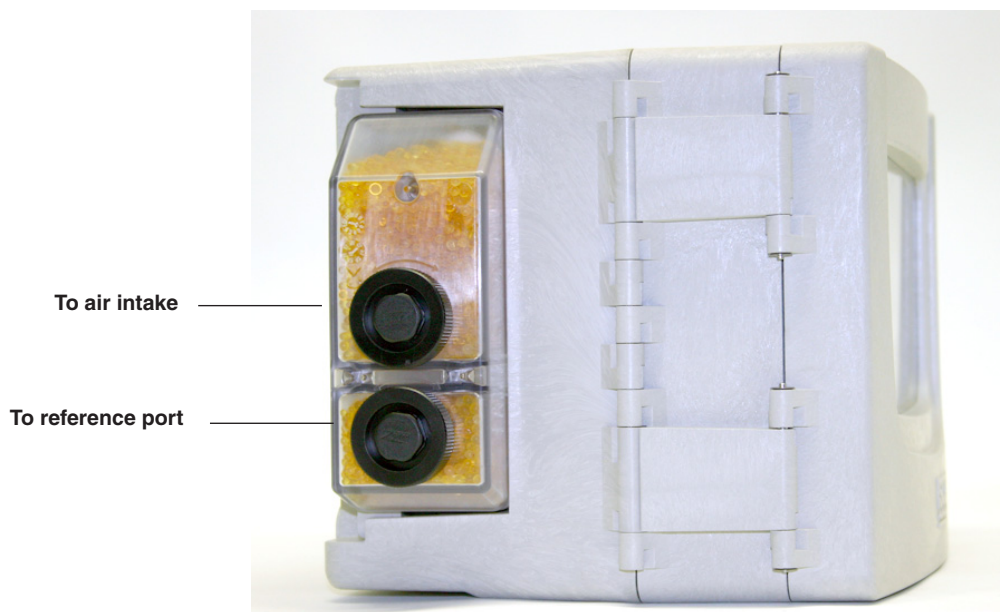


Figure 5-11 External desiccator, installed

Remove the two red protective end caps from the ports before installing a new cartridge.



Figure 5-12 Remove red caps before installing external desiccant cartridge

The desiccant cartridge is held in place by a spring tab on the side of the flow meter. Press against the front of the cartridge to disengage it from the unit.

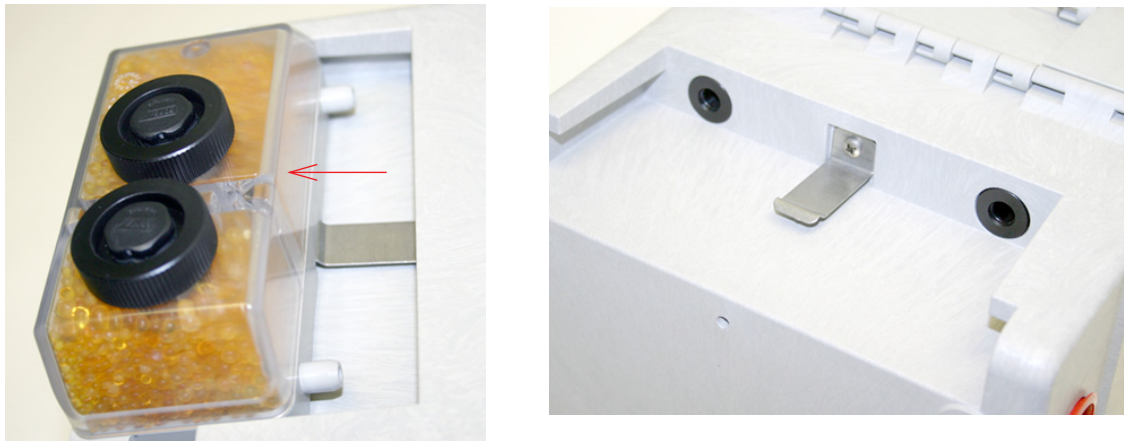


Figure 5-13 Removing the external desiccant cartridge

The desiccant cartridge requires periodic maintenance. Refer to Section 6.5.2 *External Desiccator* for instructions.

5.6 TIENet® Devices

Teledyne Isco's proprietary TIENet connectivity allows for the combination of multiple flow measurement technologies and other devices with the Signature flow meter.

5.6.1 Ultrasonic Level Sensor



The TIENet 310 Ultrasonic Level Sensor mounts directly over the flow stream. The sensor measures level by transmitting an ultrasonic pulse toward the liquid surface and then measuring the time it takes for the echo to return. The 310 is normally used with some type of primary device (typically a weir or flume) to measure flow in an open channel.

The 310 Sensor is ATEX-approved for use in potentially explosive atmospheres when specific conditions are met. Refer to the 310 user manual, as well as the control installation drawing in Section 3.8.

For complete installation and operation procedures, refer to the TIENet 310 sensor's user manual.

5.6.2 Bubbler Level Sensor



The factory-installed TIENet 330 Bubbler is normally used with some type of primary device (typically a weir or flume) to measure flow in an open channel.

The amount of pressure required to force bubbles from the end of a submerged bubble line is directly dependent on the hydrostatic pressure of the flow stream over the end of the bubble line. A pressure transducer inside the module senses this pressure and converts it into a level signal that the flow meter uses to calculate flow rate and total flow.

In order to operate with the 330 Bubbler, the Signature must have an external desiccator installed. For installation of the external desiccator, refer to Section 5.5.

Because the 330 Bubbler is a standard component in bubbler Signature meters, installation instructions are located in Section 6 *Maintenance and Servicing*, under *Installation Procedure*.

5.6.3 Laser Doppler Velocity Sensor



The TIENet 360 LaserFlow™ velocity sensor remotely measures flow in open channels with non-contact Laser Doppler Velocity technology and non-contact Ultrasonic Level technology. The sensor uses advanced technology to measure velocity with a laser beam at single or multiple points below the surface of the wastewater stream.

To operate with the LaserFlow, the Signature requires firmware version **1.18** or later. Firmware update instructions are provided in Section 6.3 *Firmware Updates*.

For complete installation and operation procedures, refer to the LaserFlow sensor's user manual.

5.6.4 Continuous Wave Doppler Velocity Sensor



The TIENet 350 Area Velocity Sensor measures flow stream average area velocity and liquid level. The Signature uses this information to calculate the flow rate and total flow of the stream. To operate with the 350 sensor, the Signature requires firmware version **1.18** or later. Firmware update instructions are provided in Section 6.3 *Firmware Updates*.

The sensor is mounted in the flow stream, normally at the bottom of the channel. It measures average velocity using continuous ultrasonic sound waves to produce a Doppler effect. The sensor measures liquid level using an internal differential pressure transducer.

In order to operate with the 350 AV sensor, the Signature must have an external desiccator installed (see Section 5.5 *External Desiccator*). Signature bubbler systems will already have a desiccator installed. If you are adding a 350 AV sensor to a non-bubbler system, you will also need to add an external desiccator.

For complete sensor installation and operation procedures, refer to the TIENet 350 sensor's user manual.

Optimal drying power

Some Signature flow meters have a single piece of tubing installed between the reference port and the humidity connector, and a cap plug on the intake port. While a Signature with this tubing configuration will operate satisfactorily with the 350 AV sensor in most situations, you can configure the tubing to utilize both chambers of the external desiccator to increase drying power and extend the desiccant service interval.

Items required:

- Plastic ‘Y’ Fitting (Part #209-0167-49)
- 0.25 x 0.125 silicone tubing (2 pcs, Part #029-1353-02)

Procedure:

1. Remove the cap plug.
2. Disconnect the tubing from the humidity connector and reroute it behind the ribbon cable.
3. Connect both the reference port tubing and the intake port tubing to the ‘Y’ connector.
4. Connect the ‘Y’ connector to the humidity connector (Figure 5-14).

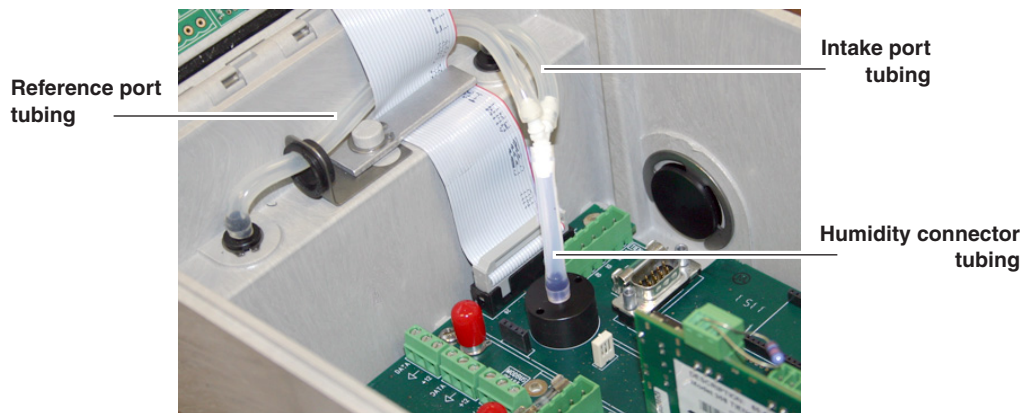


Figure 5-14 Tubing configuration for optimal drying power
(Exterior desiccator required)

5.6.5 Sampler Interface



The TIENet 306 Sampler Interface connects the Signature Flow Meter to a Teledyne Isco wastewater sampler. Through this connection, the Signature can enable the sampler based on user-specified conditions, pace the sampling routine based on flow volume, and receive sample and bottle information from the sampler.

For complete installation and operation procedures, refer to the TIENet 306 device’s user manual.

5.6.6 pH and Temperature Device

The TIENet 301 pH sensor measures the acidity or alkalinity of an aqueous solution by determining the relative quantity of dissociated hydrogen ions in the solution. The normal scale for pH runs from 0 to 14, with 0 being most acidic and 14 being the most alkaline.

For complete installation and operation procedures, refer to the TIENet 301 device's user manual.

5.6.7 TIENet Expansion Box

The water-tight expansion box connects to a TIENet terminal strip like other TIENet devices, and contains three additional strips inside, for connecting more devices. The expansion box can be daisy-chained with each box providing two additional cord grip ports. Additionally, the expansion box contains a TIENet connection for an option card (such as the 308 Analog Output option, Section 5.6.9). If an option card is used in an expansion box there is room for just one TIENet cable cord grip exiting the box.

Note

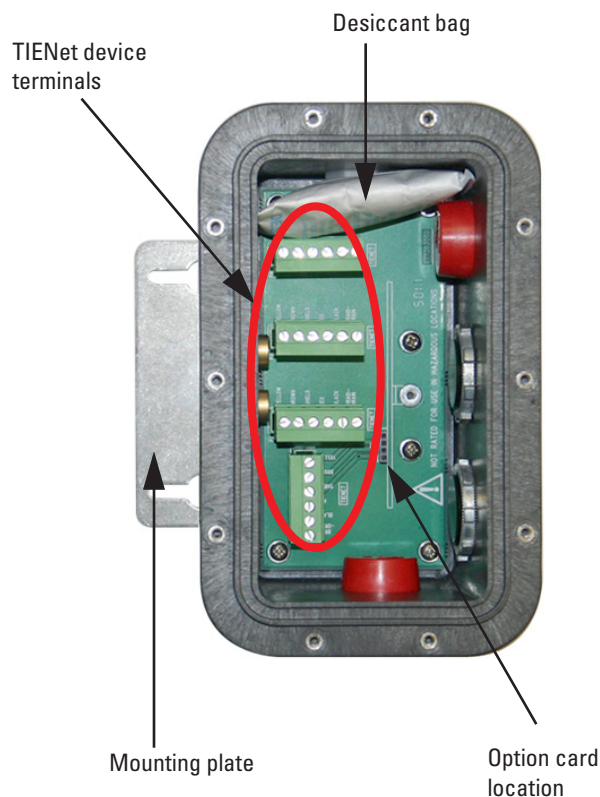
For applications requiring reference air moisture protection, please contact the factory.

Note

The expansion box is not rated for use in hazardous locations.

Enclosure Rating:
IP67 (NEMA4X, 6)

All optional cable entries must use appropriate ID conduit connections or cord-grip fittings to retain the IP67 rating. If you are using non-TIENet or non-Signature cables you must supply the appropriate ID conduit connections or cord-grip fittings.



(Cord-grip fittings are ordered separately)

Figure 5-15 TIENet Expansion Box

5.6.8 Contact Output Card (TIENet 304)

The contact output card provides a contact closure that can be enabled based off of conditions set in the equation builder.

The Signature accepts up to three internal, user-installed TIENet option cards. The 304 contact output card provides two contact outputs per card for connection between the Signature meter and non-Isco process control equipment that requires a contact output.

WARNING

The 304 contact output card is not recommended for voltages above 60vDC or 48vAC.

CAUTION

Use proper static dissipation when handling circuit boards.

Programming menus and data display distinguish each output by serial number and channel number.

Tools required

T-15 Torx driver

To install a card:

1. Remove power from the Signature flow meter and open the case, as previously described in *Connecting External Devices*, on page 3-1.
2. The option card includes a mounting screw. Remove the tubing retainer from the screw.
3. Remove the 3-pin header clip from its socket on the board.
4. Connect the receiving wires to the terminals according to their labeling (positive and ground).

Note that Contact 1 and Contact 2 are identified on the back of the board.

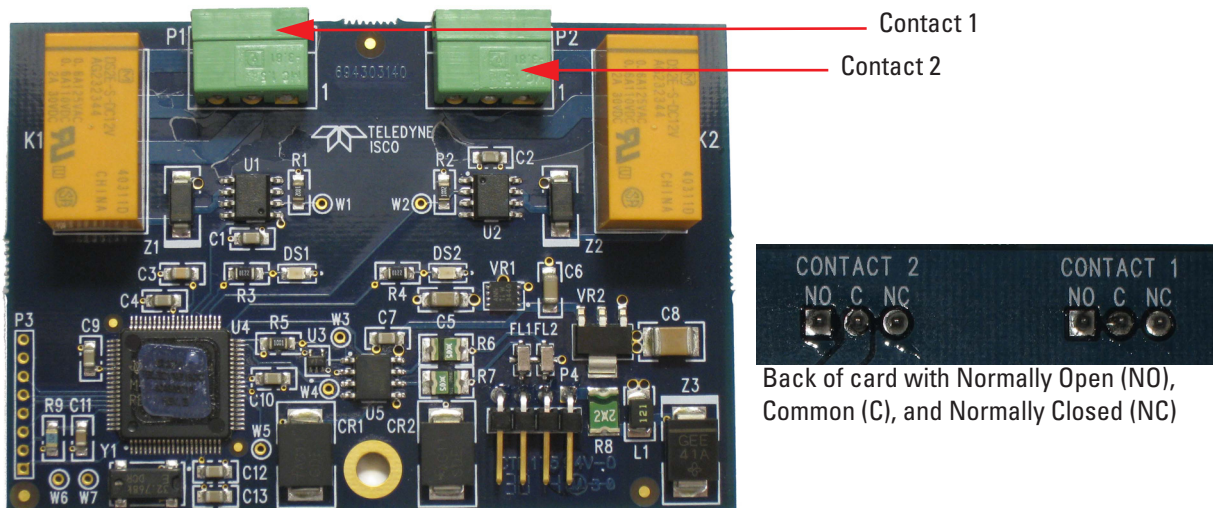


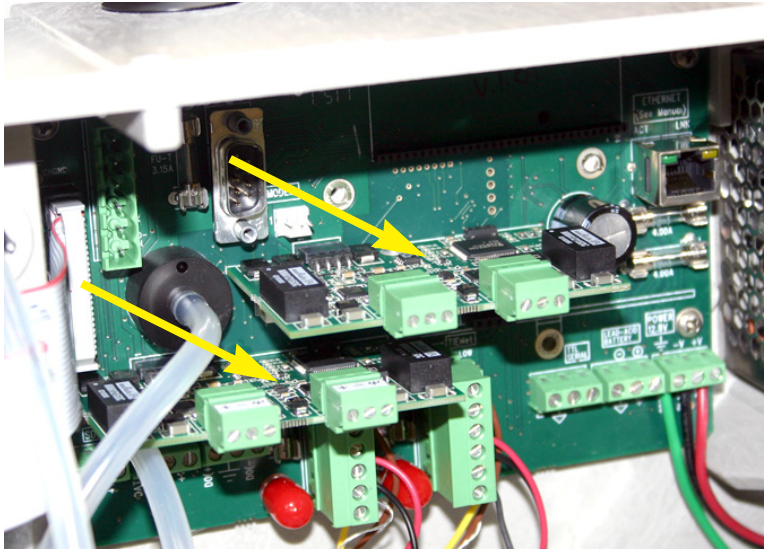
Figure 5-16304 contact output card front and back view

✓ Note

- **Normally Open (NO):** When the condition is met, the circuit will be open.
- **Common (C):** There is always be a connection to the common.
- **Normally Closed (NC):** When the condition is met, the circuit will be open.

5. Gently press the card down so that the 4-pin connector **P4** plugs into one of the three analog output jacks on the board (Item 'J' in Figure 3-2).

6. Secure the card in place by tightening its mounting screw with the T-15 Torx driver. Do not overtighten.



Two cards are shown here. The Signature accepts up to three cards at once, for a possible six simultaneous input/output channels.

Figure 5-17 View of two cards installed

7. Feed the clip with receiving wires through the appropriate port on the bottom of the meter, and press the clip down into its socket on top of the card.

Note

Cabling is user-supplied. Shielded cable is recommended. For cord-grip fitting options, refer to Appendix B, Section B.3. If conduit is used, the conduit and wiring must be sealed to prevent entry of harmful gases and/or moisture.

Configuration

The 304 measurement configuration screen includes the 304 digital output option.

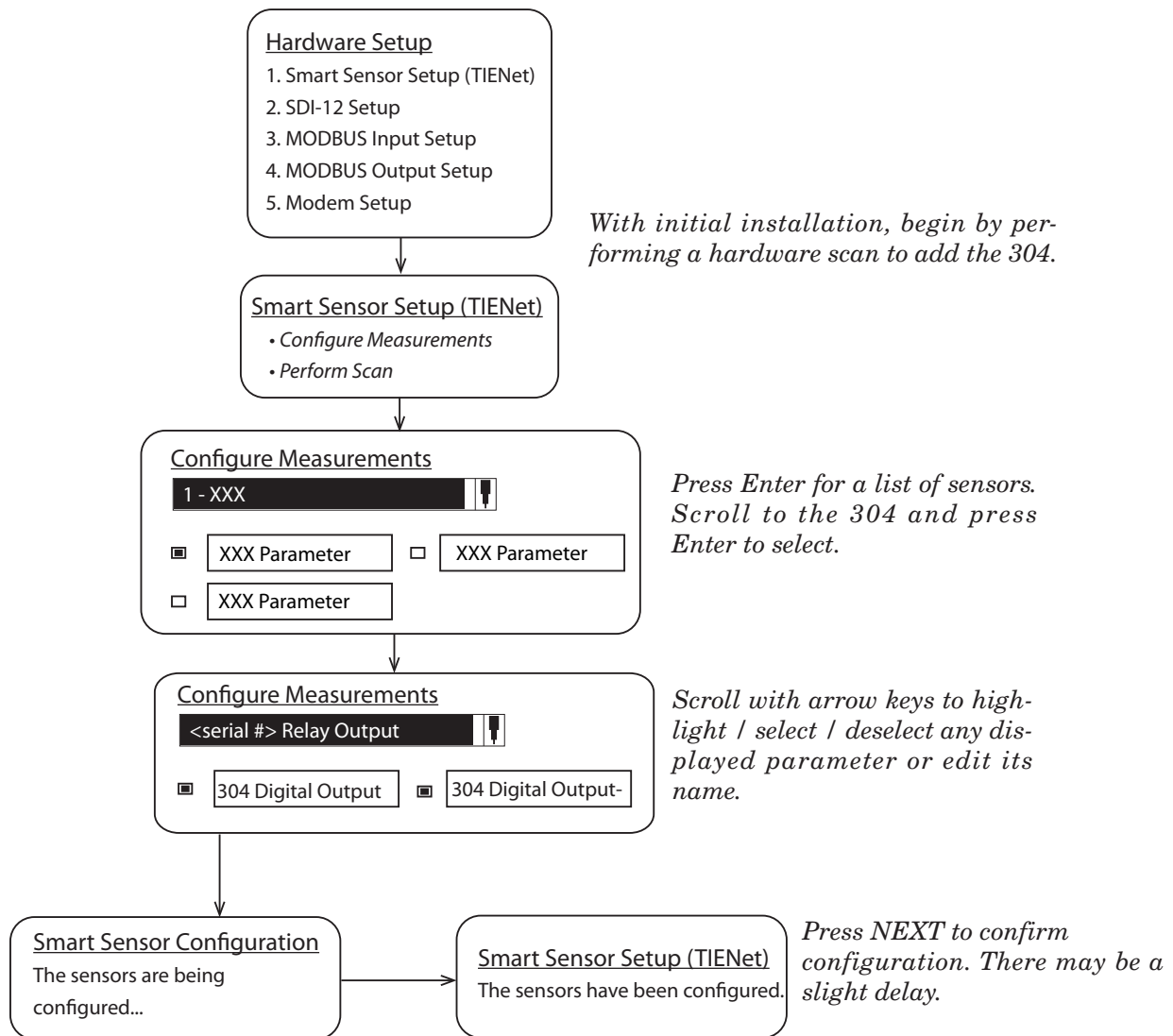


Figure 5-18 304 contact output device configuration

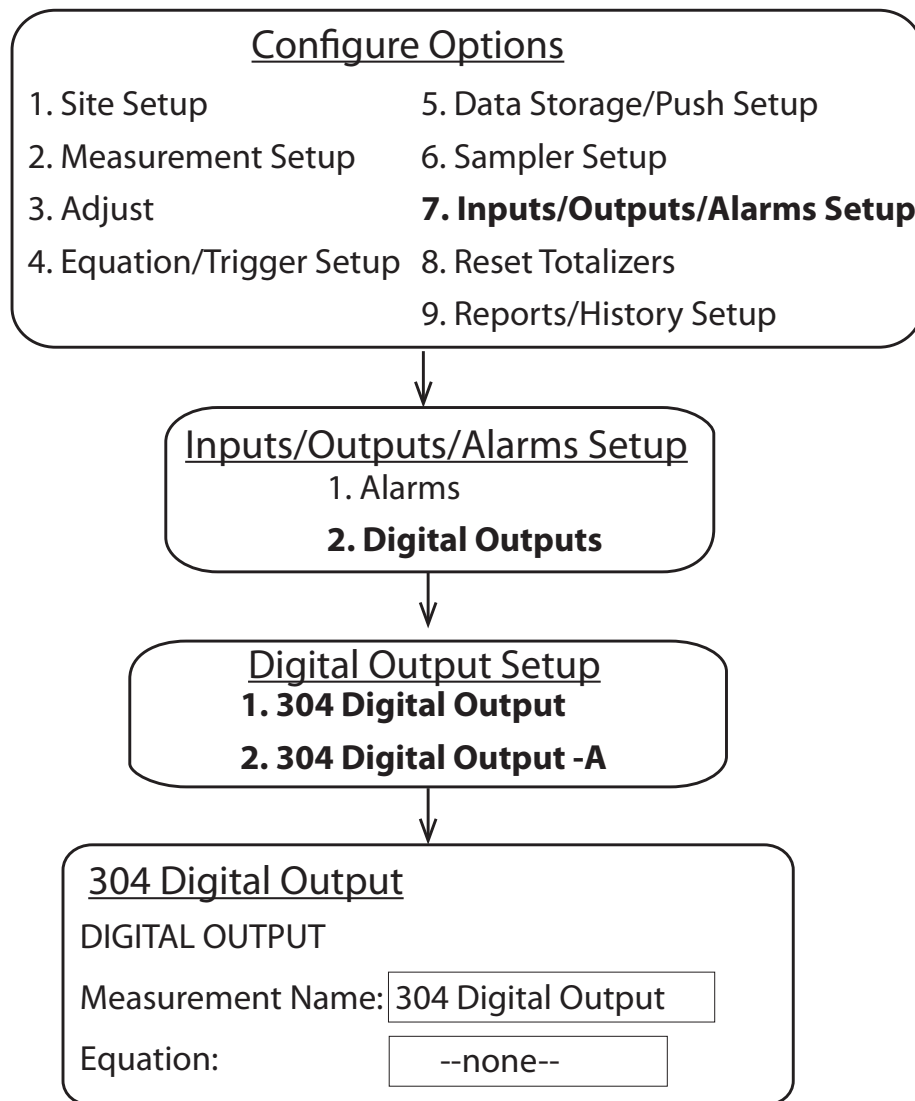


Figure 5-19 304 contact output setup

5.6.9 Analog Input Card (TIENet 307)

The 307 analog input card allows the Signature to record an analog signal as a number of data types from several different units.

The Signature accepts up to three internal, user-installed TIENet 307 option cards. The 307 analog input card provides two 4-20mA inputs a piece for connection between the Signature meter and non-Isco process control equipment or other equipment that outputs a 4-20mA current signal.

CAUTION

Use proper static dissipation when handling circuit boards.

Programming menus and data display distinguish each output by serial number and channel number.

Tools required

T-15 Torx driver

To install a card:

1. Remove power from the Signature flow meter and open the case, as previously described in *Connecting External Devices*, on page 3-1. If the LED is green, a current is flowing.
2. The option card includes a mounting screw. Remove the tubing retainer from the screw.
3. Remove the 3-pin header clip from its socket on the board.
4. Connect the receiving wires to the terminals according to their labeling (positive and ground).

Note that Channel 1 and Channel 2 are identified on the back of the board.

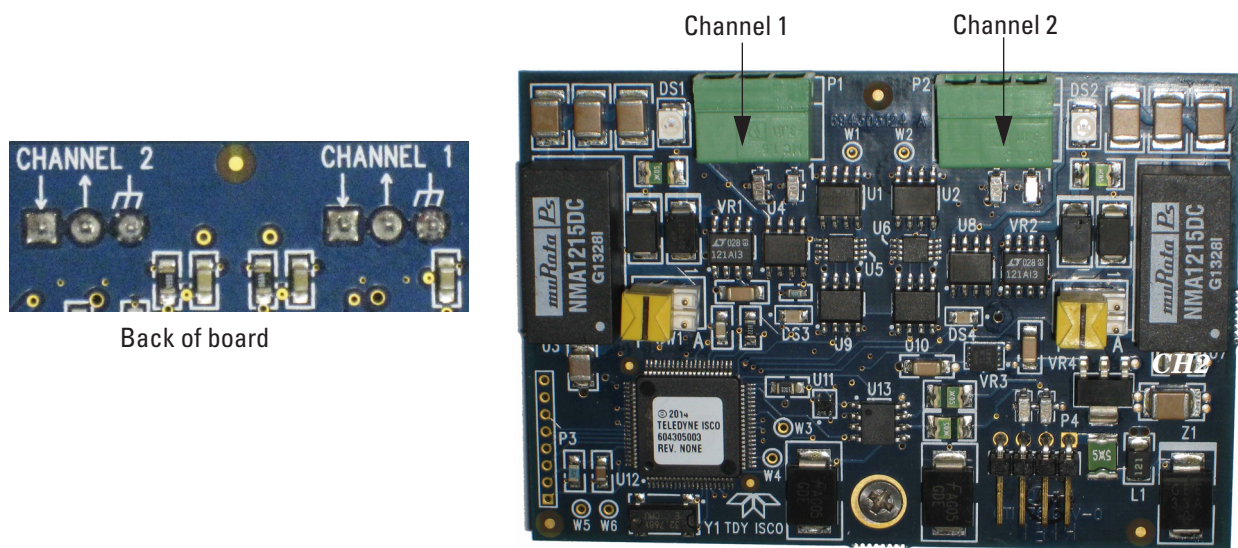


Figure 5-20307 analog input channel identification and terminal connections

5. Gently press the card down so that the 4-pin connector **P4** plugs into one of the three analog output jacks on the board (Item 'J' in Figure 3-2).
6. Secure the card in place by tightening its mounting screw with the T-15 Torx driver. Do not overtighten.
7. Feed the clip with receiving wires through the appropriate port on the bottom of the meter, and press the clip down into its socket on top of the card.

✓ Note

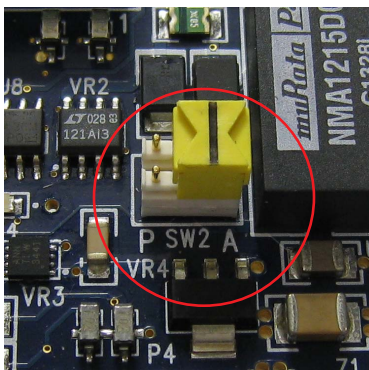
Cabling is user-supplied. Shielded cable is recommended. For cord-grip fitting options, refer to Appendix B, Section B.3. If conduit is used, the conduit and wiring must be sealed to prevent entry of harmful gases and/or moisture.

Channels

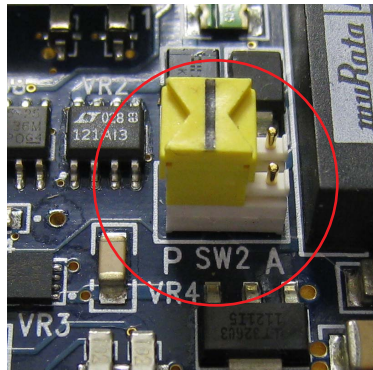
The orientation of the wires is dependent on the setting of the channel. If the channel is set to active, the positive wire is connected to the out arrow. The connection will be reversed for the passive mode.

Table 5-1 Direction of arrows and mode types

Switch	Out (arrow pointing away from the board)	In (arrow is pointing toward the board)
Switch is in the active mode (A)	Positive	Negative
Switch is in the passive mode (P)	Negative	Positive



Active Mode



Passive Mode

NOTE: Active mode supplies power to the loop. Passive relies on another device powering the loop.

Figure 5-21 Direction of switch in active and passive modes

Configuration

The 307 measurement configuration screen includes a reading at 0% (minimum or 4 ma) and a reading at 100% (maximum or 20ma) as well as a scaling option.

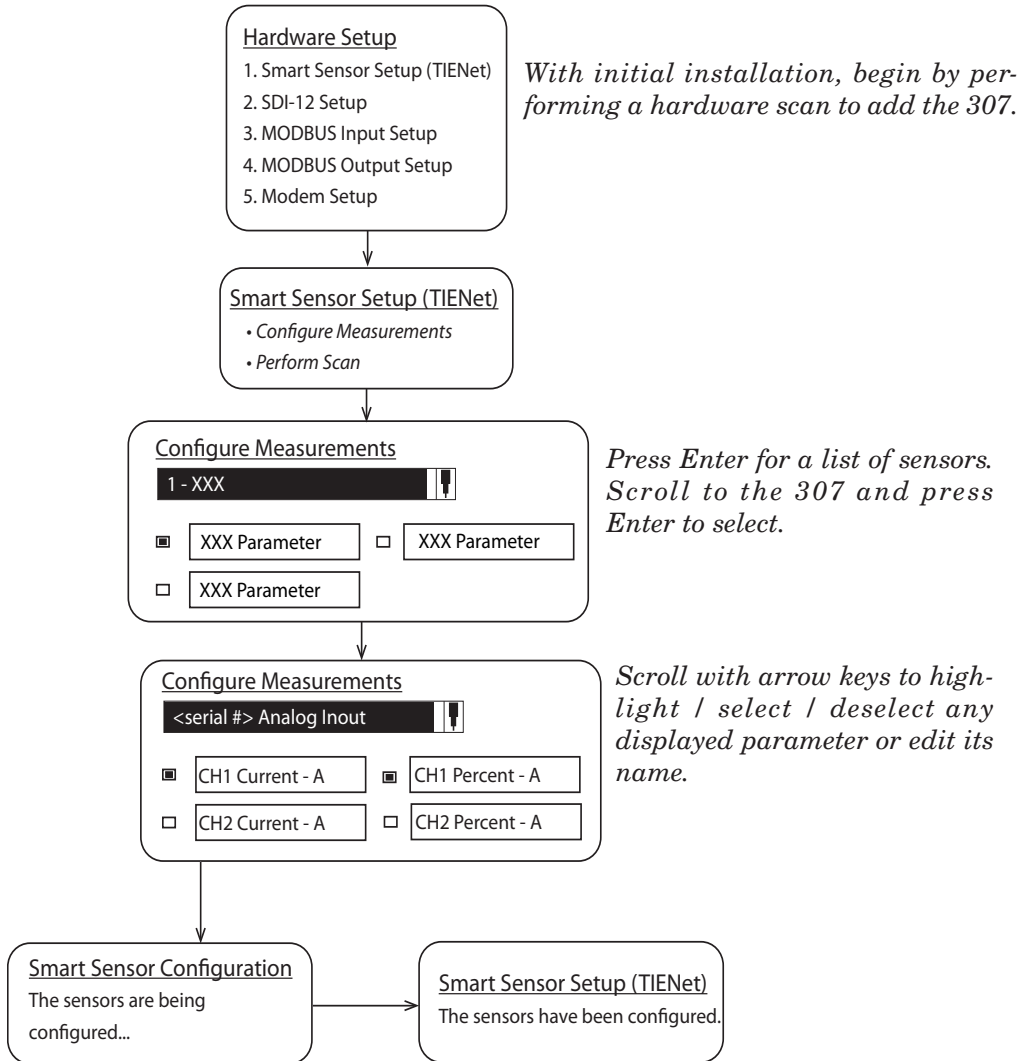
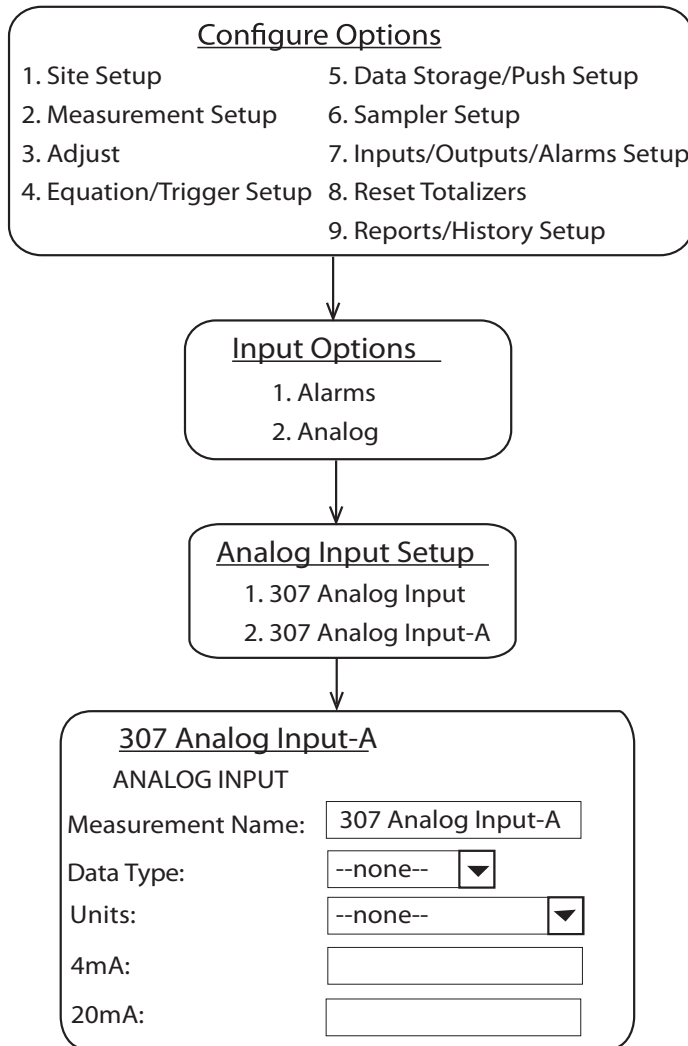


Figure 5-22 307 analog input device configuration



Press Enter for the list of parameters.

To edit units of measure, highlight and press Enter. Percent and humidity UOM are % only.

Figure 5-23 307 analog input setup

5.6.10 Analog Output Card (TIENet 308)

The 308 analog output cards convert digital information from the flowmeter to a variable analog output current ranging from 4 to 20 milliamperes. When a parameter measured by the flow meter is converted into an analog output, 4 mA becomes the 0%, or baseline, for the parameter, while 20 mA becomes the 100%, or full-scale, of the parameter. For basic programming steps, refer to Figures 5-18 and 5-19.

The Signature accepts up to three internal, user-installed TIENet option cards. The 308 analog output card provides two scalable 4-20mA outputs per card for connection between the Signature meter and non-Isco process control equipment or other equipment that accepts a 4-20mA current signal.

CAUTION

Use proper static dissipation when handling circuit boards.

Programming menus and data display distinguish each output by serial number and channel number.

Tools required

T-15 Torx driver

To install a card:

1. Remove power from the Signature flow meter and open the case, as previously described in *Connecting External Devices*, on page 3-1.
2. The option card includes a mounting screw. Remove the tubing retainer from the screw.
3. Remove the 3-pin header clip from its socket on the board.
4. Connect the receiving wires to the terminals according to their labeling (positive and ground) (Figure 5-24).

✓ Note

Channel 1 and Channel 2 are identified on the back of the board.

✓ Note

If your analog signal line has a drain DO NOT connect that to the ground connection of the 308 Analog Output card (Figure 5-24). It can become a source to inject noise into the circuit.

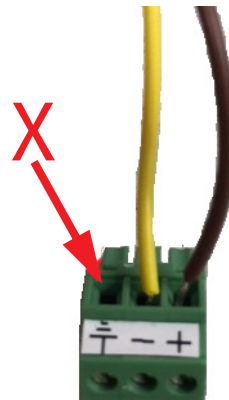


Figure 5-24 DO NOT connect to the ground connection

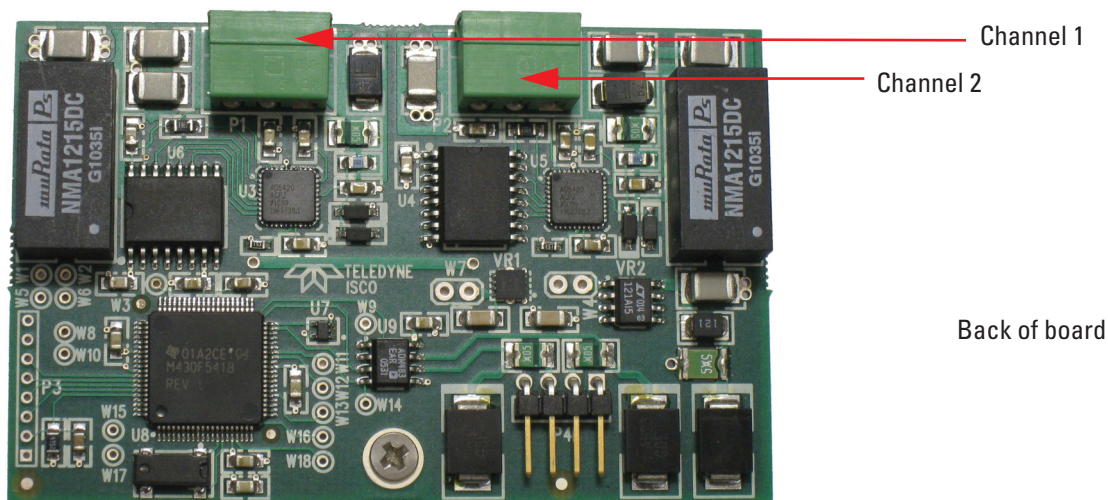


Figure 5-25 308 analog output channel identification and terminal connections

5. Gently press the card down so that the 4-pin connector **P4** plugs into one of the three analog output jacks on the board (Item 'J' in Figure 3-2).
6. Secure the card in place by tightening its mounting screw with the T-15 Torx driver. Do not overtighten.
7. Feed the clip with receiving wires through the appropriate port on the bottom of the meter, and press the clip down into its socket on top of the card.

Note

Cabling is user-supplied. Shielded cable is recommended. For cord-grip fitting options, refer to Appendix B, Section B.3. If conduit is used, the conduit and wiring must be sealed to prevent entry of harmful gases and/or moisture.

Configuration

The 308 measurement configuration screen includes a minimum and maximum reading as well as a scaling option.

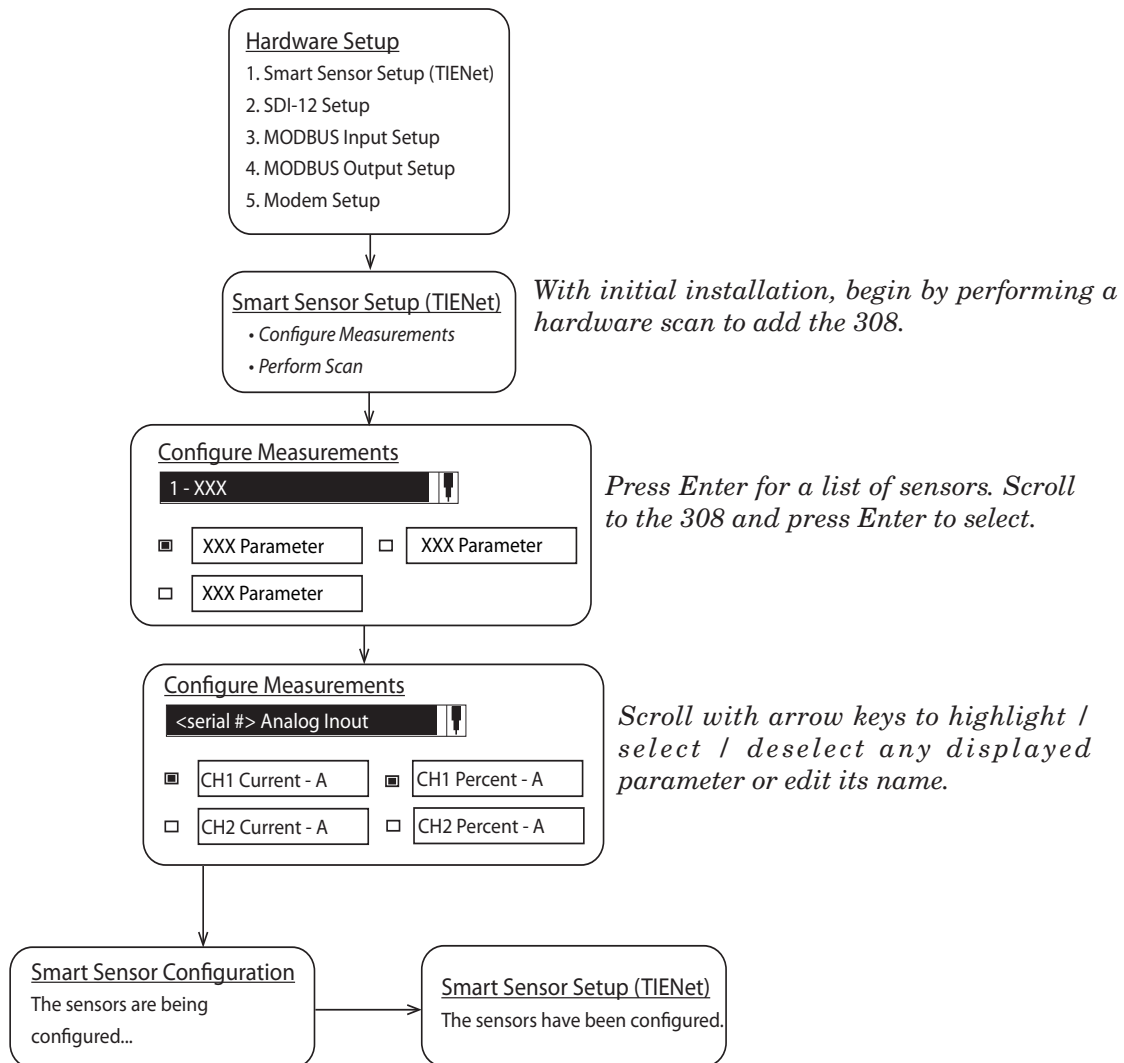


Figure 5-26 308 analog output device configuration

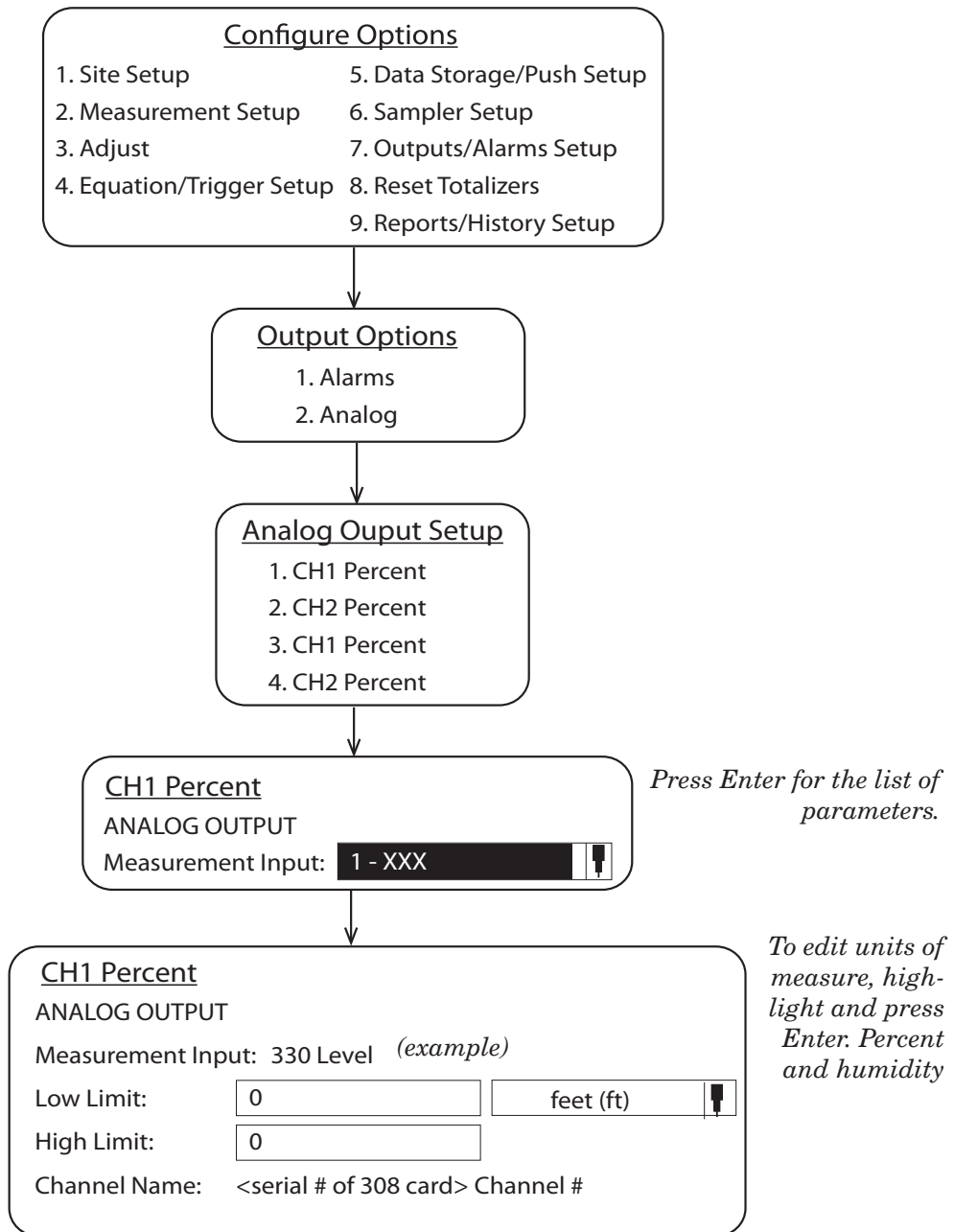


Figure 5-27 308 analog output setup

5.7 Isco Flowlink Software



Flowlink® is Teledyne Isco's proprietary software system for data acquisition, storage, retrieval, and analysis. Using the interface of Microsoft Windows, Flowlink can be used to remotely program the Signature Flow Meter, retrieve data from the flow monitoring system, present site data graphically, and generate statistical information from the site data.

Flowlink helps ensure data integrity by displaying the Signature's tracked configuration changes, data measurement summaries, diagnostic test results, and user events in the program. With these tools, Flowlink provides assurance that the data has not been altered.

USB drivers for computer direct connection to the Signature Flow Meter are included on the Flowlink CD, and must be loaded prior to direct connection between the computer and the Signature.

See Section *Connecting to the Signature with Flowlink*, on page 2-2 for instructions on how to connect to the Signature meter with Flowlink software.

From Flowlink, the event data can be exported and saved in the form of text reports on your computer, searchable by site name, module, and date. For complete information, refer to Section *Signature Data in Flowlink*, on page 2-35.

5.8 Ethernet Modem

Setup and data retrieval, as well as alarm output configuration, can be accomplished remotely via TCP/IP communication protocol with a static address, using Flowlink software and the ethernet modem to access the Signature's web browser. The ethernet modem is factory-installed on the connector case.

The ethernet modem can also be installed by the user. Remove line and/or optional battery power from the Signature Flow Meter and open the case as previously described in Section 3.2.

CAUTION

Always use proper static dissipation methods when handling circuit boards.

DANGER

Before opening the case, first ensure that mains power is disconnected from the unit.

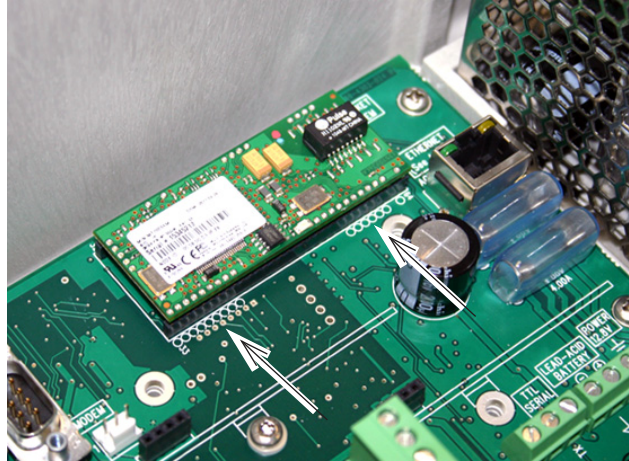
CAUTION

Before opening the case, disconnect the optional battery backup power, if used.

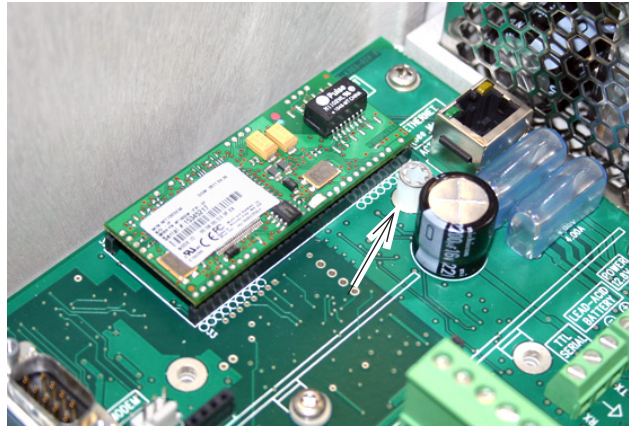


Figure 5-28 Ethernet modem kit contents

1. Press the modem assembly down into its socket on the connector case (item G in Figure 3-2 *Connector case, connectors, and fuses*), with the row of dots along the bottom left and right edges aligned with the row of circles on the board to ensure proper orientation.



2. Place the plastic spacer over the screw hole by the bottom right corner of the modem.
3. Place the lock washer on top of the spacer.



4. Place the rectangular retainer over the lockwasher, with the counter-sink facing up, and attach with the screw.



Figure 5-29 Ethernet modem installation

In order to communicate with the Signature Flow Meter using the ethernet modem, your network must have TCP/IP services installed. A static IP address must be reserved for the Signature, and client network computers must be allowed to access the static IP address.

5.8.1 Ethernet Modem Configuration

When installation is complete and power restored, wait one minute for the Signature to recognize the modem before programming.

Note

The Signature does not support Dynamic Host Configuration Protocol (DHCP). The network communication information (IP, gateway, and subnet mask) must come from your network administrator and be entered manually into the flow meter.

When you select Modem Setup from the Hardware Setup menu, the type of modem installed determines what screen is displayed.

To configure the Signature for ethernet communication, you must have the following information on hand prior to Hardware Setup:

IP Address – An Internet Protocol (IP) address is the unique numerical label assigned to each device (e.g., computer, printer, flow meter, etc.) on a computer network for interface identification and location addressing. The Signature’s Ethernet modem requires a *Static* IP address for remote communication.

TCP Port – The default port setting is 1700. This is the communication port associated with the static IP address on your network.

Gateway Address – The gateway is the point of communication that joins two different networks with different base IPs.

Subnet Mask – This is the umbrella location that allows multiple nodes to communicate within the network.

It designates a subnetwork within the larger network. Traffic between subnetworks is exchanged or routed through the Gateway.

Special network access may be required to configure these settings. For further assistance, contact your network administrator.

Hardware Setup

1. Smart Sensor Setup (TIENet)
2. SDI-12 Setup
3. MODBUS Input Setup
4. MODBUS Output Setup
- 5. Modem Setup**

Modem Setup

Modem Model:	MULTITECH MT 100 SEM
Static IP Address:	<input type="text" value="000.000.000.00"/>
TCP Port:	<input type="text" value="1700"/>
Gateway Address:	<input type="text" value="000.000.000.000"/>
Subnet Mask:	<input type="text" value="255.255.255.0"/>

Figure 5-30 Ethernet modem setup: Communication settings (default settings shown)

5.8.2 Network Firewall Settings

In order for your network administrator to identify the Signature in the network firewall setup, it must have a node ID (also known as the MAC address). This is the NODE ID printed on the ethernet modem's serial tag (refer to Figure 5-31).

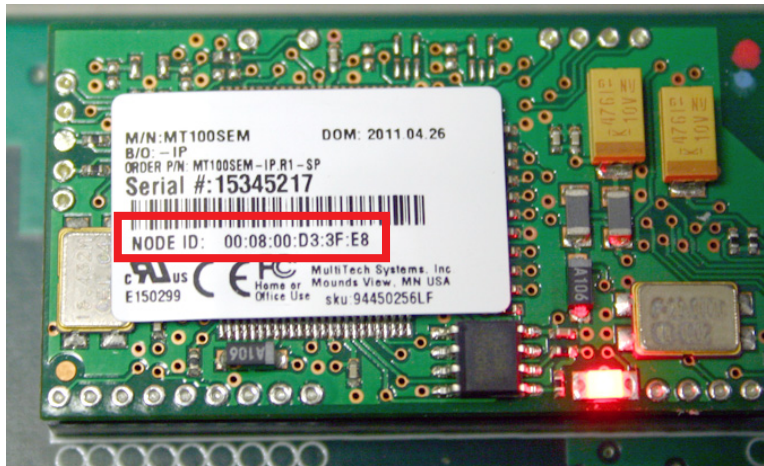


Figure 5-31 Locating the NODE ID (MAC address) on the ethernet modem

5.9 Cellular Modems

Setup and data retrieval through the Signature's web browser, as well as alarm outputs, can be accomplished remotely with one of the available cellular modems. The whip-style antenna has a magnetic mounting base.



Figure 5-32 LTE antenna-

5.9.1 CDMA Modem

The Code Division Multiple Access (CDMA) modem can automatically push data to a secure server running Isco Flowlink Pro software, with 1xRTT data transmission.

Note

The modems shown do not necessarily represent the modems installed.



Figure 5-33 CDMA Cellular modem

5.9.2 GSM Modem

The Global System Mobile (GSM) modem can automatically push data to a secure server running Isco Flowlink Pro software, with HSPA+ data transmission.

Your service parameters, or provider, can be changed by replacing the removable Subscriber Information Module (SIM) card in your modem.

Note

The modems shown do not necessary represent the modems installed.



Figure 5-34 GSM Cellular modem-

5.9.3 LTE Modem

The Long Term Evolution (LTE) modem can automatically push data to a secure server running Isco Flowlink Pro software, with LTE data transmission your service parameters or provider, can be changed by replacing the removable Subscriber Information Module (SIM) card in your modem.

5.9.4 SIM Card

The data transmission capabilities of the GSM and LTE modems are dependant upon the type of service plan you have through your cell phone service provider. The service parameters, or provider, can be changed by simply replacing the SIM card in your modem. Check with your service provider to verify what data transmission technologies are available for your use. There are three types of SIM cards, but only Standard (Mini) SIM cards and Micro SIM cards will work in the GSM and LTE modems. Standard (Mini) SIM cards are preferred but Micro SIM cards can be used with the included adapter.

Note

A Standard (Mini) SIM or Micro SIM card is required for any GSM or LTE units including the Signature modems.

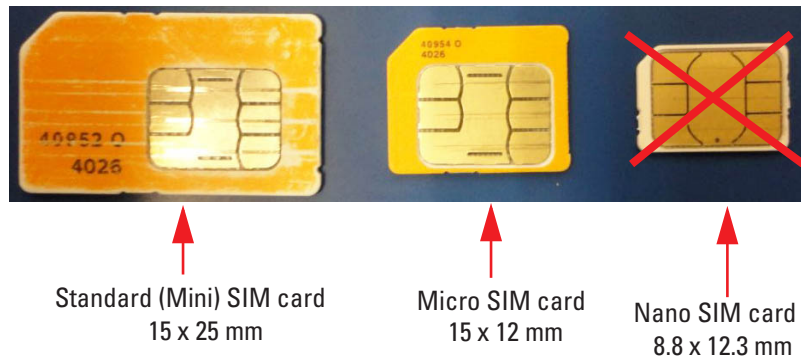


Figure 5-35 Types of SIM cards

5.9.5 Installing the Cellular Modem

The modem kit includes the modem, power cable, DB9 serial cable, and coaxial antenna plug cable.

Note

Before installing the modem, remove the top label (with the FCC ID on it) taped to the modem and adhere it to the outside of the Signature case on the bottom of the unit, on the left side, in the largest of the three sections (Figure 5-36). This is required by the FCC.

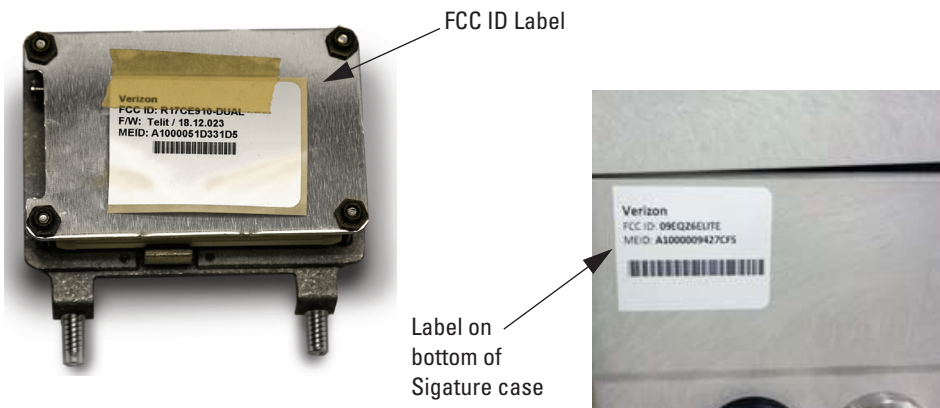


Figure 5-36 FCC ID label on modem and location of label on the bottom of Signature case

1. Remove line power from the Signature Flow Meter and open the case as previously described in Section 3.2.

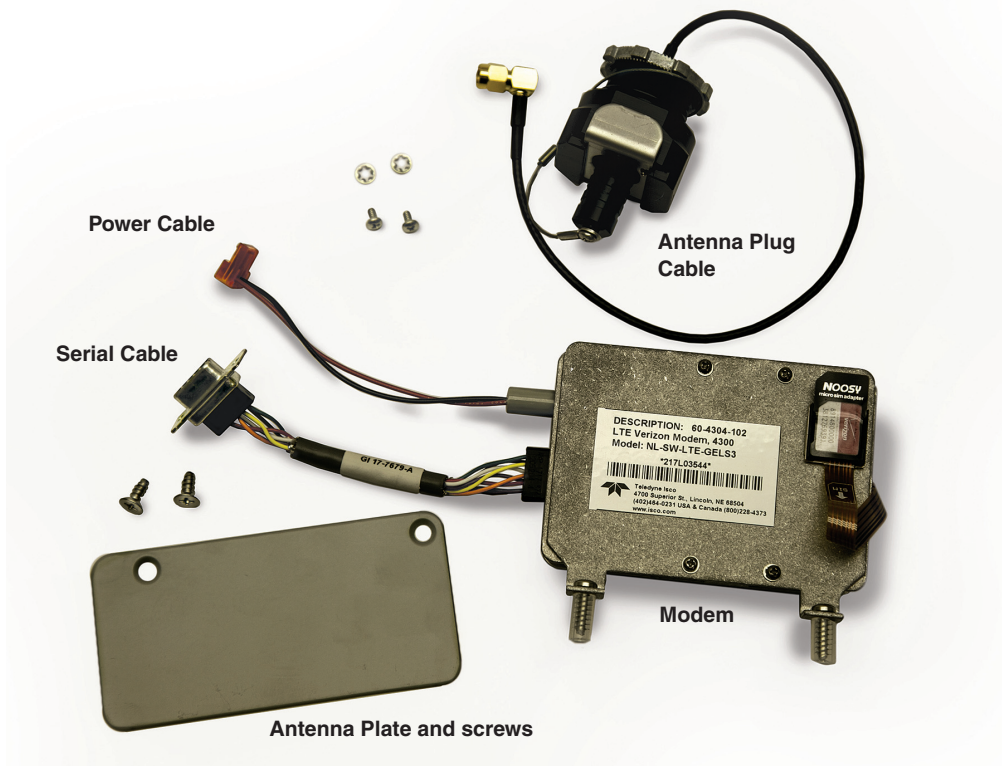


Figure 5-37 Cellular modem kit contents

2. Install the plug in the preferred port (far left most commonly used). Route the antenna plug cable under any other cabling, and install the plug in any open port.
3. Connect the three cables to the modem.
4. Remove the screw retainers and fasten the modem's mounting bracket against the connector case, as shown below, using the two mounting screws.
5. Plug the serial and power cables into their respective connectors on the board.

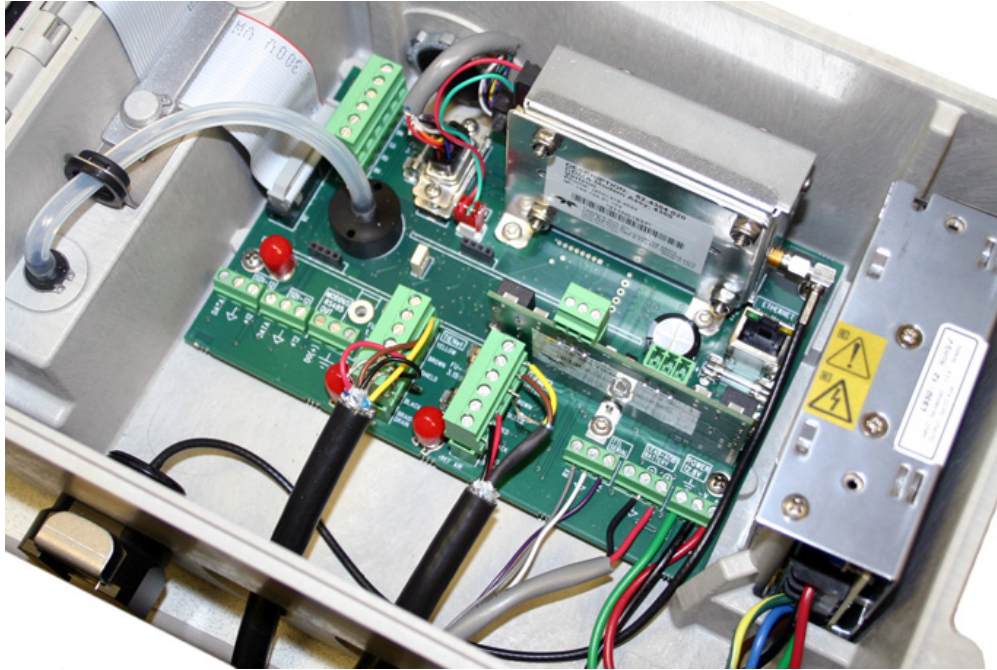


Figure 5-38 Cellular modem installation

5.9.6 Cellular Modem Configuration

When installation is complete and power restored, wait one minute for the Signature to recognize the modem before programming.

When you select Modem Setup from the Hardware Setup menu, the type of modem installed determines what screen is displayed.

To set up the Signature Flow Meter for cellular communication, select either internet (IP) or CSD (outside of the USA) for the connection.

For the LTE or GSM modem, an Access Point Name (APN) is used, select SINGLE for the operating mode and enter the name.

For portable applications the modem can be set up with the call in the time window. To conserve power, the time window does not effect the push/outgoing connections. The time window restricts when the meter can be acceded via a modem connection.

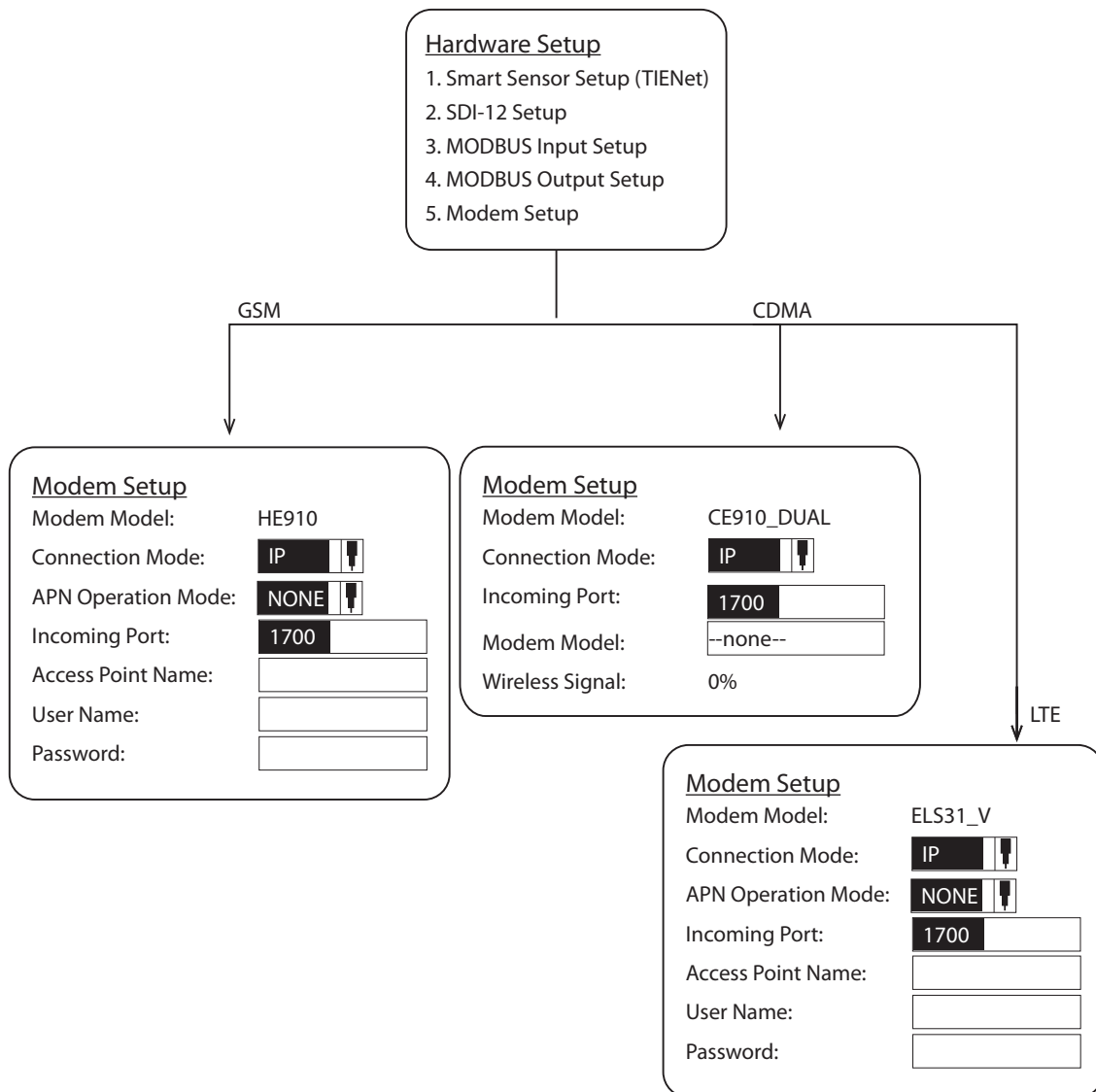


Figure 5-39 Cellular modem setup: Communication settings

Signature® Flow Meter

Section 6 Maintenance and Servicing

6.1 Maintenance

The following tables are recommended maintenance checks to ensure proper operation. As site conditions may vary, increase the frequency of inspections as needed.

Table 6-1 Recommended Maintenance (Accessible Locations)

Action	Recommended Frequency	Location
Check desiccant for appropriate color ^a	Monthly or following humidity error	On-site
Check bubble line for plugs or obstructions	Monthly	On-site
Check bubble line for kinks	Monthly	On-site
Check pump run time during manual purge ^b	Monthly	On-site
Check for level measurement errors	Weekly	Via Flowlink application

- a. When dry, the desiccant appears orange in color.
- b. If the run time is >15 seconds, replace the intake gore filter.

Table 6-2 Recommended Maintenance (Difficult-to-Access Locations)

Action	Recommended Frequency	Location
Check desiccant for appropriate color ^a	Every 6 months or following humidity error	On-site
Check bubble line for plugs or obstructions	Every 6 months	On-site
Check bubble line for kinks	Every 6 months	On-site
Check pump run time during manual purge ^b	Every 6 months	On-site
Check for level measurement errors	Weekly	Via Flowlink application

- a. When dry, the desiccant appears orange in color.
- b. If the run time is >15 seconds, replace the intake gore filter.

6.2 Cleaning

The Signature flow meter may be cleaned with water and a mild detergent. For hard to remove stains, isopropyl alcohol may be used. If the instrument is in an isolated area and the case is sealed closed, it may be cleaned using a water hose.

6.3 Firmware Updates

Signature and TIENet device firmware updates are provided in the form of .bin files, which will be available for download from the Teledyne Isco website. Note that firmware updates do not remove any program settings or delete data.

To install an update:

1. Create a folder in the top directory of a flash drive, and name it BINFILE.
2. Download the .bin file to be installed. To find your correct .bin file, go to www.isco.com and click on *Software / Firmware Updates* in the lower left corner. Select *Open Channel Flow Measurement*.



Figure 6-1 Locating firmware updates

3. Save the new .bin file(s) to the BINFILE folder you created on the flash drive.

4. Using the flash drive adaptor cable provided with the Signature, connect the flash drive to the micro-USB assembly on the flow meter's front panel.

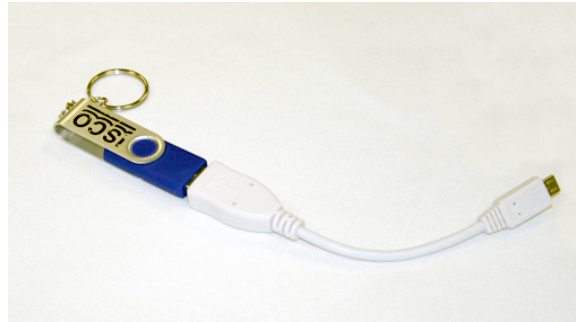


Figure 6-2 USB Micro adaptor cable (flash drive not included)

5. The USB Options menu appears on the display. Select option #3, Update Firmware.
6. You will be prompted to select either Signature or TIENet firmware. Select the appropriate .bin file from the pull down menu and press NEXT.
 - a. **Update Signature Firmware**

The update will load for approximately three minutes. During this time, do not make any changes to the Signature. When the firmware load is complete, the Signature will prompt you to remove the USB drive. An automatic reboot then occurs over a period of approximately five minutes, during which the green LED signals that an internal operation is in progress. Do not unplug the flow meter or press any keys until the Home screen appears. In the event that the upload fails, contact Teledyne Isco.
 - b. **Update TIENet (Smart Sensor) Firmware**

Select the radio button next to each device to be updated and press NEXT. The progress of the sensor firmware update(s) will be displayed. A confirmation screen will appear when the update is complete.
 - c. **Bootcode**

This option is only used when the update(s) failed and the sensor is no longer responding. Select the "Bootcode" option, then select the appropriate file from the drop-down menu to be updated. All other updates are inactive when this option is selected.

6.4 Accessing the Interior

Some maintenance or servicing tasks require opening the Signature housing to access the interior. Always refer to this section prior to doing so.

DANGER

Before opening the case, first ensure that mains power is disconnected from the unit.

CAUTION

Before opening the case, disconnect the optional battery backup power, if used (refer to Figure 5-8 *Backup battery, installed*).

✓ Note

Before restoring mains power, ensure that the flow meter's USB connector does not have a cable attached.

Open the door to access the two large screws holding the front panel on the connector case. Remove the two screws, then reinsert them in the front panel and latch the lid so they will not be misplaced.

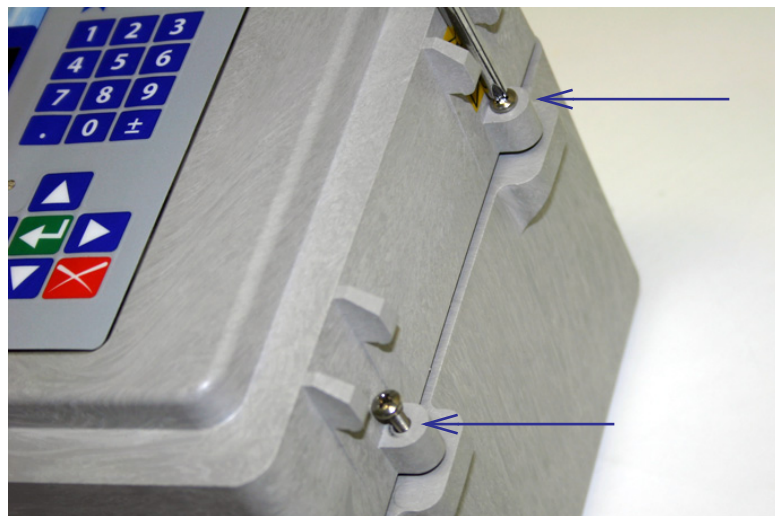


Figure 6-3 Open door and front panel to access interior

6.5 Desiccant

The inside of the flow meter housing must be kept dry at all times to prevent moisture damage to the internal components. All Signature flow meters have an internal desiccant bag to absorb moisture. Signature flow meters using a 330 bubbler also require an external desiccator.

If increased humidity is indicated by either the humidity reading of the flow meter or the color of the external desiccant, the desiccant must be renewed or replaced before damage occurs.

If this occurs more frequently than expected, inspect the seals of cord-grip fittings and conduit, if used.

Humidity alarm

The humidity of the case interior, reference (ambient) air, and bubble intake air (if a 330 bubbler is installed) are all parameters that can be selected as conditions to trigger an alarm, notifying you when it is time to renew or replace your desiccant.

The suggested alarm setting is a threshold condition of 40%. For detailed instructions about setting up conditions and alarms, refer to Sections *Equation / Trigger Setup*, on page 2-25, and *Inputs / Outputs / Alarms Setup*, on page 2-27.

6.5.1 Internal Desiccator

Saturated internal desiccant bags must be replaced; unlike the external desiccant, they are not renewable.

The desiccant bag is held in place by a metal bracket. Remove the two screws holding the bracket.

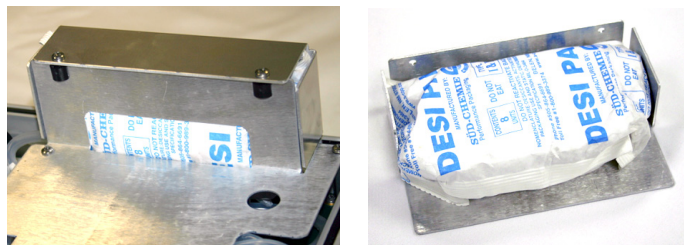


Figure 6-4 Removing the internal desiccant bag

6.5.2 External Desiccator

The desiccator vents the reference port for a pressure transducer, and the air intake port for the bubbler system air pump, keeping the interior of the flow meter case dry.

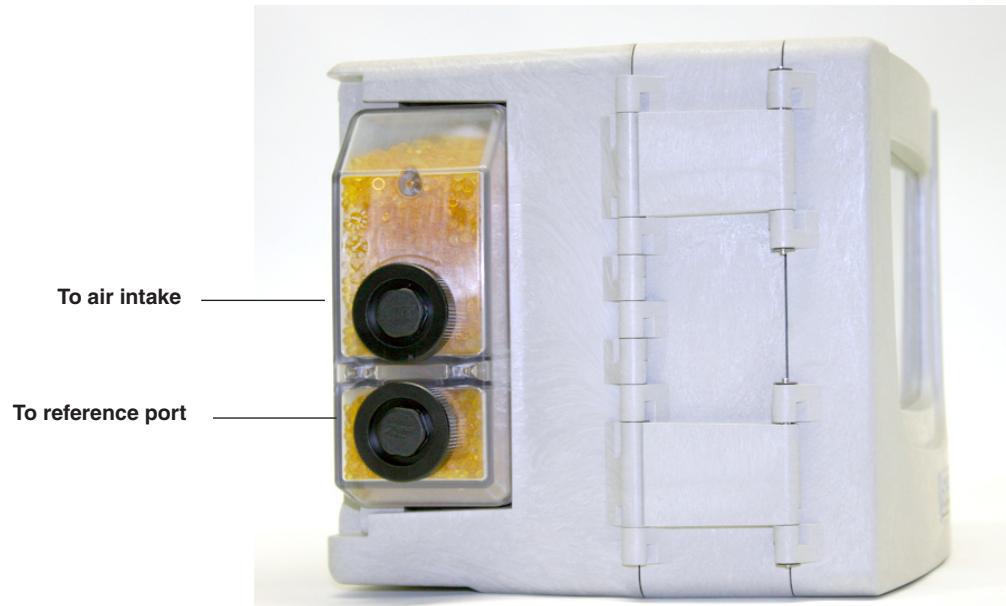


Figure 6-5 External desiccator, installed

When dry, the loose silica gel desiccant inside the chambers is orange or yellow. When the desiccant becomes saturated with moisture, it turns green or blue, indicating that the intake air and reference line are no longer protected from humidity.

Note

Teledyne Isco recommends checking the desiccant at least every 6 months, and changing/renewing the desiccant before the entire compartment has changed color.

Dry desiccant
(good)

Saturated
desiccant (bad)



Figure 6-6 Desiccant indicating saturation

The desiccant cartridge is held in place by a spring tab on the side of the flow meter. Press against the front of the cartridge to disengage it from the unit.

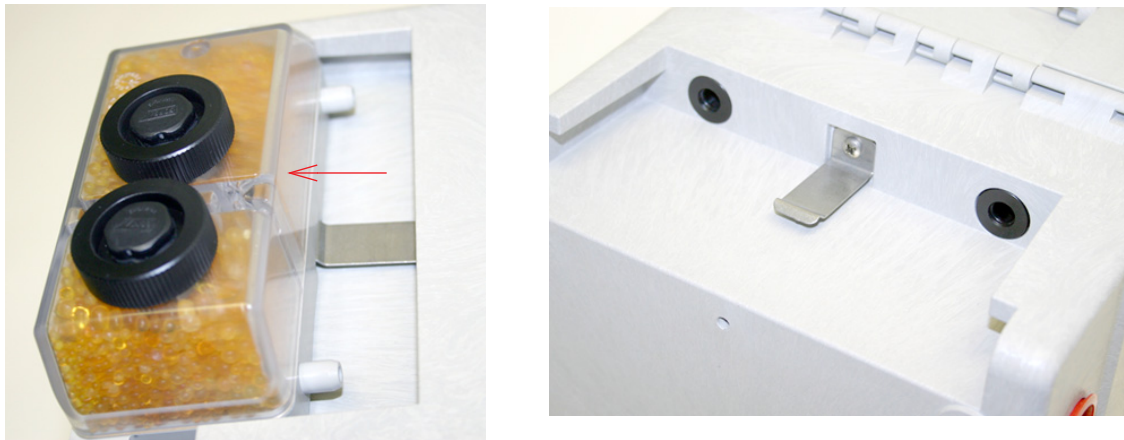
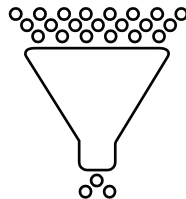


Figure 6-7 Removing the external desiccant cartridge

Unscrew the two black caps and carefully pour the desiccant out. If removal is difficult, screw the caps back in and unscrew again. Gently knock the caps and the cartridge against a hard surface to free any small particles in the threads, as these can hinder proper sealing and cause wear.

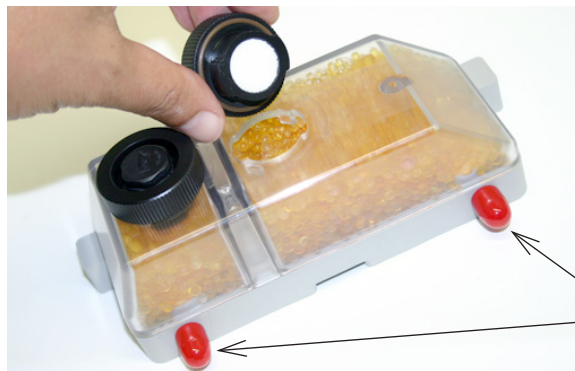
Using a funnel, fill both chambers with dry desiccant, replace the caps, ensuring that they are fully engaged. Press the cartridge back into place on the side of the flow meter.

Use a funnel to refill the desiccator.



Note

If this is a new desiccant cartridge, remove the two red protective end caps from the ports before installing a new cartridge.



Remove red caps before installing cartridge.

Figure 6-8 Opening the desiccant cartridge chambers

Renewing loose desiccant

To renew the desiccant, spread it in a single layer on a flat metal tray. Place in a vented, circulating forced air, conventional oven in a well ventilated room, and heat at 100 - 175°C (212 - 350°F) for about three hours, or until the color has returned to orange or yellow.

MSDS (Material Safety Data Sheets) for silica gel chemicals are provided in Appendix C.

6.6 Troubleshooting

The tables in the following section provide troubleshooting information to help in determining the causes of problems that may occur with the Signature flow meter or TIENet devices.

The troubleshooting tables cover the flow meter and each TIENet device separately. Note that the 300 TIENet device (Table 6-4) is the internal connector case.

 **Note**

Any time a circuit board is replaced or a sensor disconnected, you **MUST** perform a hardware scan and SDI-12 scan (if connected) before resuming operation.

6.6.1 Signature Flow Meter

Table 6-3 Troubleshooting: Signature Flow Meter

Symptom	Cause	Action	Parts
Display repeatedly goes blank	Power setting is set to turn display off	If key is not pressed within 5 minutes, press any key to turn the display on.	
Blank Display but audible beep when a key is pressed	Contrast is out of adjustment	Adjust the display contrast by repeatedly pressing the up or down arrow while holding down the +/- key.	
	Faulty Display	Replace with known good display.	Display 130-0602-06

Table 6-3 Troubleshooting: Signature Flow Meter (Continued)

Symptom	Cause	Action	Parts
Blank display and no beep when a key is pressed	Open Fuse F3	Replace 4A/250V/5X20mm Slo Blo fuse (Figure 3-2 <i>Connector case, connectors, and fuses</i> , Item L). If the fuse opens again, check for devices that may be shorting the supply, such as an external connection, modem or option card.	4A Fuse 411-9901-84
	Dead Lead-Acid Battery	Replace or recharge the main battery connected to the internal "Lead-Acid" terminals.	60-3004-106 Model 946 Lead-Acid Battery
	DC power supply not supplying 12.8 VDC output.	Check for proper AC voltage. If proper AC voltage is present, replace DC power supply.	DC Power Supply 60-4304-037
	Broken or loose wire from power supply module to the connector case.	Service check: Disconnect the internal power supply wires (Red +/pos, Black -/neg) from the power terminals (Figure 3-2 <i>Connector case, connectors, and fuses</i> , Item F). Connect an Isco adaptor cable to the power terminals (Black +/pos, White -/neg). Then connect an Isco power supply (Model 913, 914, 923, or 924) to the adaptor cable. If the Signature then functions properly, replace the internal power supply.	Isco Adaptor Cable 69-4304-034
	Broken or loose wire from power supply module to the connector case.	Repair connections (Red +/pos, Black -/neg).	

Table 6-3 Troubleshooting: Signature Flow Meter (Continued)

Symptom	Cause	Action	Parts
Blank display and no beep when a key is pressed (Con't.)	Ribbon cable loose or damaged	Check or cycle connections, then replace with known good cable.	Ribbon Cable 69-4304-032
	Defective keypad	Substitute a known working keypad.	Keypad 69-4303-009
	Faulty or missing SD card	Reinstall or replace SD card on Main CBA.	SD Card 250-3000-66
	Main CBA faulty	Substitute with known good Main CBA.	Main CBA 60-4304-042
Nonresettable totalizer does not advance	Programming error - Zero flow rate or asterisk (*)	Check measurement configuration of level, flow rate, and volume input for the Total Flow parameter.	
	Broken wire connection	Check wire connections for the totalizer on the Main CBA.	
	Defective totalizer	Replace totalizer	Mechanical Totalizer 60-4304-015
USB device not recognized - No USB Options screen	Flash drive encrypted or defective	Try a different USB Flash drive	
	Adaptor cable defective	Replace cable	USB Adaptor Cable 480-2946-02
	Micro-USB Assembly damaged	Replace port	Micro-USB Assembly 60-4304-053
Cannot update software / Read flash drive	The necessary files are not on the flash drive.	Load the firmware from our website onto the flash drive, into a folder named BINFILE.	www.isco.com
	SD Card not functional or missing files.	Verify that the SD card includes a BINFILE folder with the appropriate bin file(s) inside.	Micro-USB Card 250-300-066
	Faulty Main CBA	Replace the Main CBA.	Main CBA 60-4304-042

6.6.2 TIENet 300 Connector Case

Table 6-4 Troubleshooting: TIENet 300 Connector Case			
Symptom	Cause	Action	Part
TIENet or SDI12 devices not appearing on display for configuration Refer to Section 2.6.1 & 2.6.2.	Device not configured for display on the Home Display.	Add the parameters to the Home Display. Refer to Section 2.7.1 <i>Site Setup</i> .	
	Device has not been scanned.	Perform a hardware scan from TIENet Setup or SDI-12 Setup. Refer to Sections 2.6.1 <i>Smart Sensor Setup (TIENet)</i> and 2.6.2 <i>SDI-12 Setup</i> .	
	Device is not wired correctly.	Rewire connector following label on the case circuit board.	
	Open Fuse	Check fuse FU-T 3.15A (F1, F4, F5). Replace if open. Refer to Figure 3-2 <i>Connector case, connectors, and fuses, Item K</i> .	3.15A Fuse 411-0212-70
	Defective TIENet or SDI12 device.	Substitute a known working device and rescan. If it now works, replace the faulty device.	
	Case circuit board faulty.	Substitute with known working board.	300 Connector Case CBA 60-4304-041
	Main CBA faulty.		Main CBA 60-4304-042
	Ribbon cable damaged or loose.	Check or cycle connections, then substitute with known working cable.	Ribbon Cable 69-4304-032

6.6.3 TIENet 301 pH/Temp

Table 6-5 Troubleshooting: TIENet 301 pH/Temperature Device			
Symptom	Cause	Action	Part
pH Will not calibrate	No sensor connected to the 301	Connect pH probe	
	301 module not recognized	Rescan device in Hardware Setup	
		Check TIENet wire connections. Follow wiring code silk-screened on circuit board.	
	TIENet connection fuse open	Replace if open	3.15A Fuse 411-0212-70
	Probe defective	Replace probe	pH Probe 60-9004-126

Table 6-5 Troubleshooting: TIENet 301 pH/Temperature Device (Continued)

Symptom	Cause	Action	Part
Incorrect pH readings / slow response	Buffers contaminated or wrong buffer used.	Use new/correct pH buffer solution.	
	Temperature is not being read.	Replace probe	pH Probe 60-9004-126
	Probe bulb is contaminated	Clean probe and recalibrate. If readings are still incorrect, replace probe.	
	Calibrated before reading stabilized.	Recalibrate and allow the readings to stabilize before continuing with calibration.	

6.6.4 TEINet 304 Contact Output Card

Table 6-6 Troubleshooting: TIENet 304 Contact Output Card

Symptom	Cause	Action
The 304 card is not a selectable option in the software after the card is installed.	A TIENET scan must be performed after the card is physically installed.	Perform a TIENet scan.
	In the HARDWARE SETUP SMART SENSOR SETUP CONFIGURE MEASUREMENTS, no options are selected.	In the HARDWARE SETUP SMART SENSOR SETUP CONFIGURE MEASUREMENTS, select one or more of the options.
Contact closure is not being made (verified with an ohm meter)	The Contact Output card is not configured correctly in the software.	See section 2.7.7 to configure the 304 card properly.

**6.6.5 TIENet 307 Analog
Input Card**

Table 6-7 Troubleshooting: TIENet 307 Analog Input Card

Symptom	Cause	Action
The 307 card is not a selectable option in the software after the card is installed.	A TIENet scan must be performed after the card is physically installed.	Perform a TIENet scan.
	In the HARDWARE SETUP SMART SENSOR SETUP CONFIGURE MEASUREMENTS, no options are selected.	In the HARDWARE SETUP SMART SENSOR SETUP CONFIGURE MEASUREMENTS, select one or more of the options.
The 307 card is not reading 4-20	The analog input card is not configured correctly in the software.	See section 2.7.7 to configure the 307 card properly. Use the green and yellow LED lamps to verify the hardware using the set-up menus.
	The passive/active setting is incorrect or indeterminate.	Verify the setting your device requires and change the active or passive settings on the 307 card. Verify the setting from the set-up menus.
	Improper connection.	Verify the wires are attached to the correct channels and in the correct polarity. Use the labels and LED lamps to verify the hardware using the setup menus. The green LED lamp will light when proper current is flowing in the analog circuit.
	External device is faulty or incorrectly configured.	To verify, check the output with an ampmeter.
	Over-current protection device in the 307 has been tripped.	Disconnect power from the 307 card, the Signature, and the external analog loop. Wait 30 seconds.

6.6.6 TIENet 306 Sampler Interface

Table 6-8 Troubleshooting: TIENet 306 Sampler Interface

Symptom	Cause	Action
Incorrect pacing interval	Incorrect flow total selected for pacing	Assign the correct sensor to the correct flow rate to the correct total flow. Example: Needed to pace from the 330 bubbler, but programmed to pace from the 310 USLS.
No sampler pacing	Sampler's flow pulse input not working	Connect a different sampler, or test the existing sampler by shorting pins A and C on the sampler's Flow Meter port, while the program is running. The displayed pulse count should count down.

6.6.7 TIENet 308 Analog Output

Table 6-9 Troubleshooting: TIENet 308 4-20mA Analog Output

Symptom	Cause	Action
4-20 output is missing, or zero current output	Incorrect wiring	Rewire per connector diagram
	Excessive load	Disconnect external equipment and test the output with VOM. If OK then reduce load resistance (maximum 900 Ω) or add <u>isolated</u> power to the current loop.
	Analog circuit board failure	Use the other output channel on the 308 circuit board. If current is still 0 mA, replace circuit board. If the VOM reads 4mA or greater, reprogram to use that output or replace the circuit board. Part #60-4304-006
4-20 only reads 4mA	Wires on incorrect output (wired to output 2 instead of output 1)	Move connector to proper output and verify using the yellow LED lamp indications from the setup menu.
	Analog percent is not selected in the TIENet HARDWARE SETUP SMART SENSOR SETUP CONFIGURE MEASUREMENTS	In the HARDWARE SETUP SMART SENSOR SETUP CONFIGURE MEASUREMENTS, select one or more of the options. See sections 2.6.1 <i>Smart Sensor Setup (TIENet)</i> and 2.7.7 <i>Inputs/Outputs/Alarms Setup</i> .
	Improper parameter set for the output.	Verify/change the settings/range to the proper parameter.

Table 6-9 Troubleshooting: TIENet 308 4-20mA Analog Output (Continued)

Symptom	Cause	Action
4-20 reading incorrectly	Excessive load	Disconnect external equipment and test the output with VOM. If OK then reduce load resistance (maximum 900 Ω) or add <u>isolated</u> power to the current loop.
	Improper module/parameter set for the output	Verify/change the settings/range to the correct module/parameter.
	Connected to incorrect output; e.g., wired to output 2 instead of output 1	Move connector to proper output and verify using the yellow LED lamp indications from the setup menu.
The 308 option card is not a selectable option in the software after the card is installed.	TIENet 308 is not properly configured	Verify the TIENet configuration contains analog percent readings
Measurement error for analog current	No load applied to the output circuit, or open circuit wiring.	The output must have a load resistance (maximum 900 Ω). For verification, this can be accomplished by connecting the current meter leads to the terminals of the 308 card.
External device not reading 4-20	Over-current protection device in the 307 has been tripped.	Disconnect power from the 307 card, the Signature, and the external analog loop. Wait 30 seconds.

6.6.8 TIENet 310 USLS

Table 6-10 Troubleshooting: TIENet 310 Ultrasonic Level Sensor

Symptom	Cause	Action
Invalid level, display has asterisk (*) by level reading	Not scanned	Perform a smart sensor scan
	Not able to achieve signal lock (misalignment, loose mounting, turbulence, foam, or debris in the water)	Adjust mounting or place over a solid surface.
	Level outside of the Blanking distances	Adjust min/max blanking distances
	Not wired correctly	Check/repair wiring
	Open fuse	Replace fuse FU-T 3.15A and rescan. Part #411-0212-70. Refer to Figure 3-2 Item K.
	Failed sensor	Replace with known good sensor
No level reading on the display	Parameter not selected to be displayed on Home Display	Add the parameter to the Home Display. Refer to Section 2.7.1 <i>Site Setup</i> .

Table 6-10 Troubleshooting: TIENet 310 Ultrasonic Level Sensor (Continued)

Symptom	Cause	Action
Incorrect level reading	Level not adjusted properly	Readjust level
	Sensor misaligned	Realign sensor
	Objects in the path of the signal	Adjust min/max blanking distances and/or reposition sensor.
	Sensor exposed to direct sunlight	Install sunshade. Refer to Appendix B <i>Options and Accessories</i> .

Air Supply of Bubbler

The bubbler's air supply is brought into the air pump thru a desiccator, filter, humidity sensor, and into the intake of the air pump.

Output of Air Pump

Past the output of the air pump is a check valve that allows pressurized air from the air pump to enter the air tank. The air pump is programmed to maintain a pressure in the air tank measured by a pressure transducer (P4 referenced thru P3 vented to reference air).

Normal Operation

During normal operation, the air purge solenoid is shut as air passes thru the filter, bubble orifice, and to the bubble out. Air passes thru the autozero valve to the pressure transducer P1 (referenced to P2 which is vented to reference air). The pressure measurement taken at P1 is used to calculate the level reading.

Purge Cycle

During the purge cycle, the purge valve is opened allowing all the pressure in the tank to vent through the bubble out.

Autozero

The Signature automatically performs an autozero. During an autozero, the autozero valve is activated tying P1 and P2 together so an autozero of the pressure transducer can be performed.

6.6.9 Installation Procedure Referring to Figures 6-9, and 6-11, perform the following steps.

1. Place the bubbler assembly on top of the main CBA, ensuring that the four screw holes line up in the case, and the 10-pin connector engages correctly in its socket.
2. Attach the bubbler board to the control panel using the four self-tapping screws previously (part #231-6149-07). Do not overtighten.

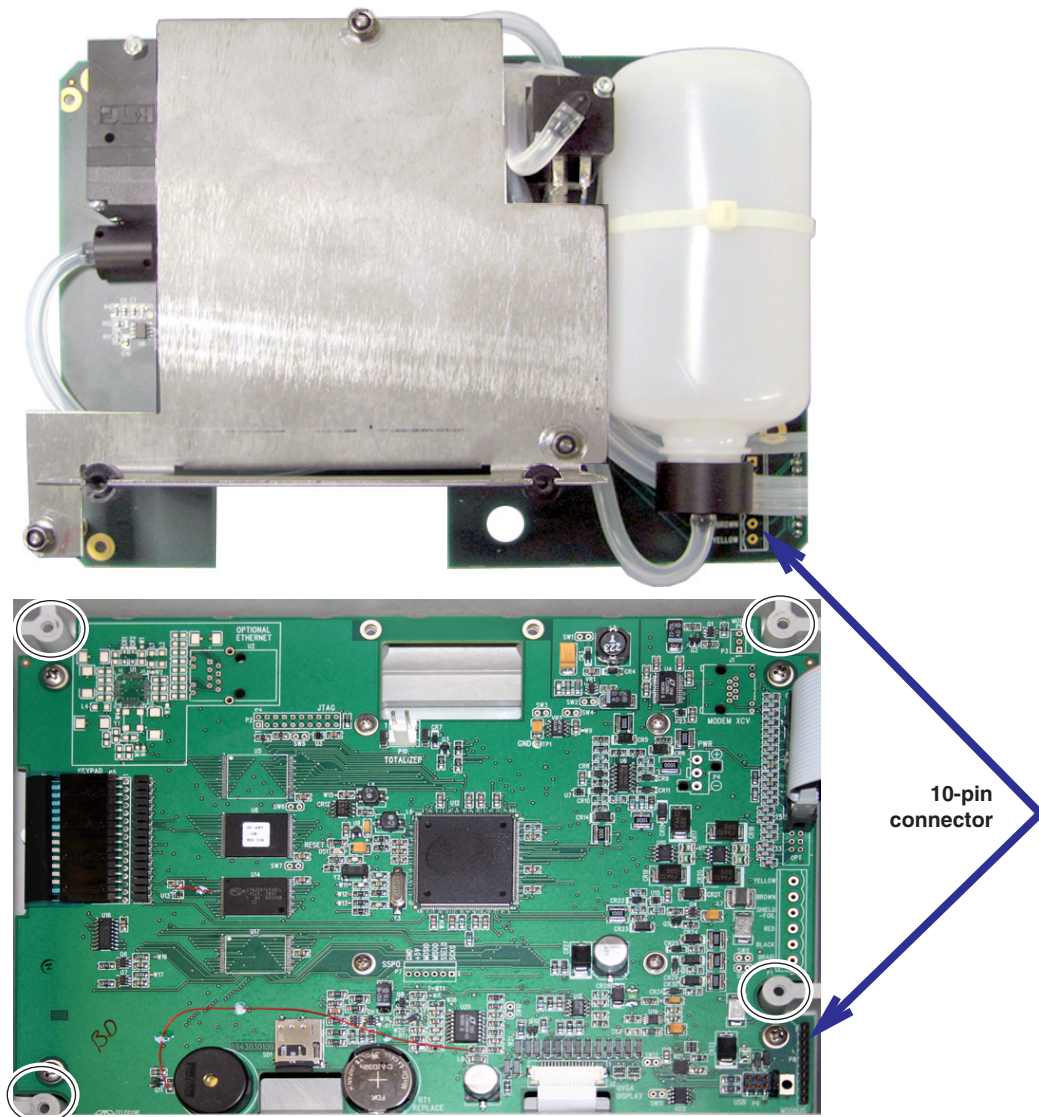


Figure 6-9 330 Bubbler assembly installation

Note

There are three pieces of tubing on the bubbler that must be correctly connected for operation. If any tubing is damaged, please purchase 1 meter of part #029-1353-02 and cut to the length needed for replacement. For additional information about tubing connections, refer to Section in Appendix A *Replacement Parts*.

3. Replace the port plug in the bottom of the case (usually second from the left) with the bubble line fitting.
4. Route the reference line tubing (with fitting on the end) through the bushing and press the fitting into the reference connector on the connector case.
5. Route the intake tubing (the shorter of the two open-ended tubes) through the bushing and behind the ribbon cable, and connect it to the intake port in the case wall.
6. Route the other end of the short tubing through the bushing and connect it to the humidity connector on the board.
7. Connect the bubble tubing (the longer of the two open-ended tubes) to the bubble line port in the bottom of the case.

Some Signature flow meters have a 'Y' fitting connecting both the reference and intake ports to the humidity connector.

When installing a 330 bubbler in a unit with this tubing configuration, remove the 'Y' fitting and two shorter pieces of tubing. Bring the reference port tubing out from behind the ribbon and reroute it directly to the humidity connector.

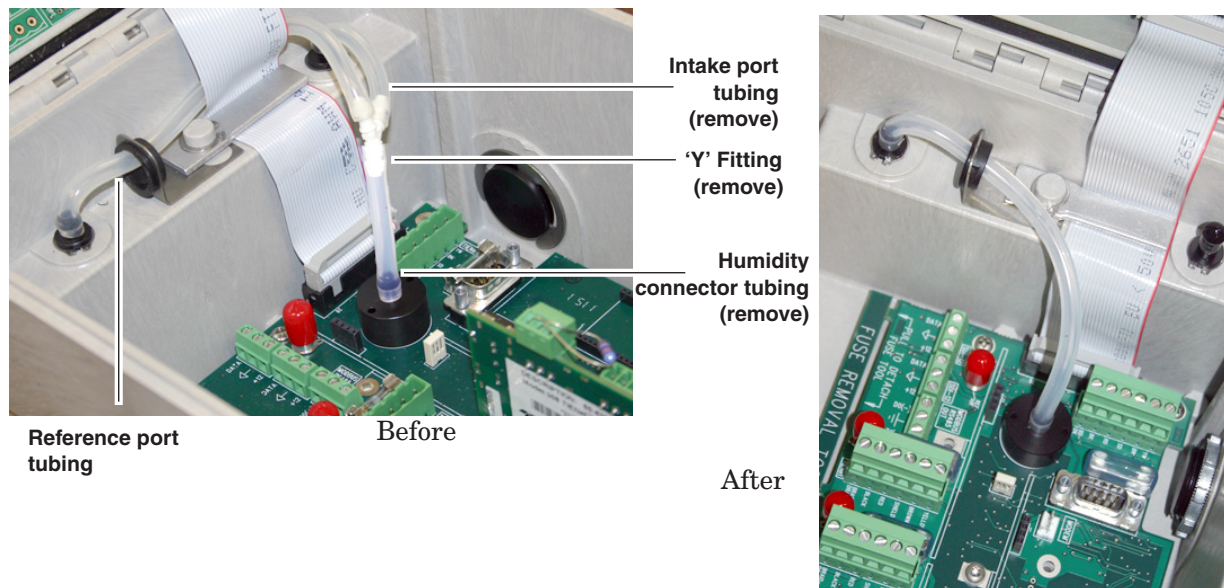


Figure 6-10 Remove extra tubing and fitting (if applicable)

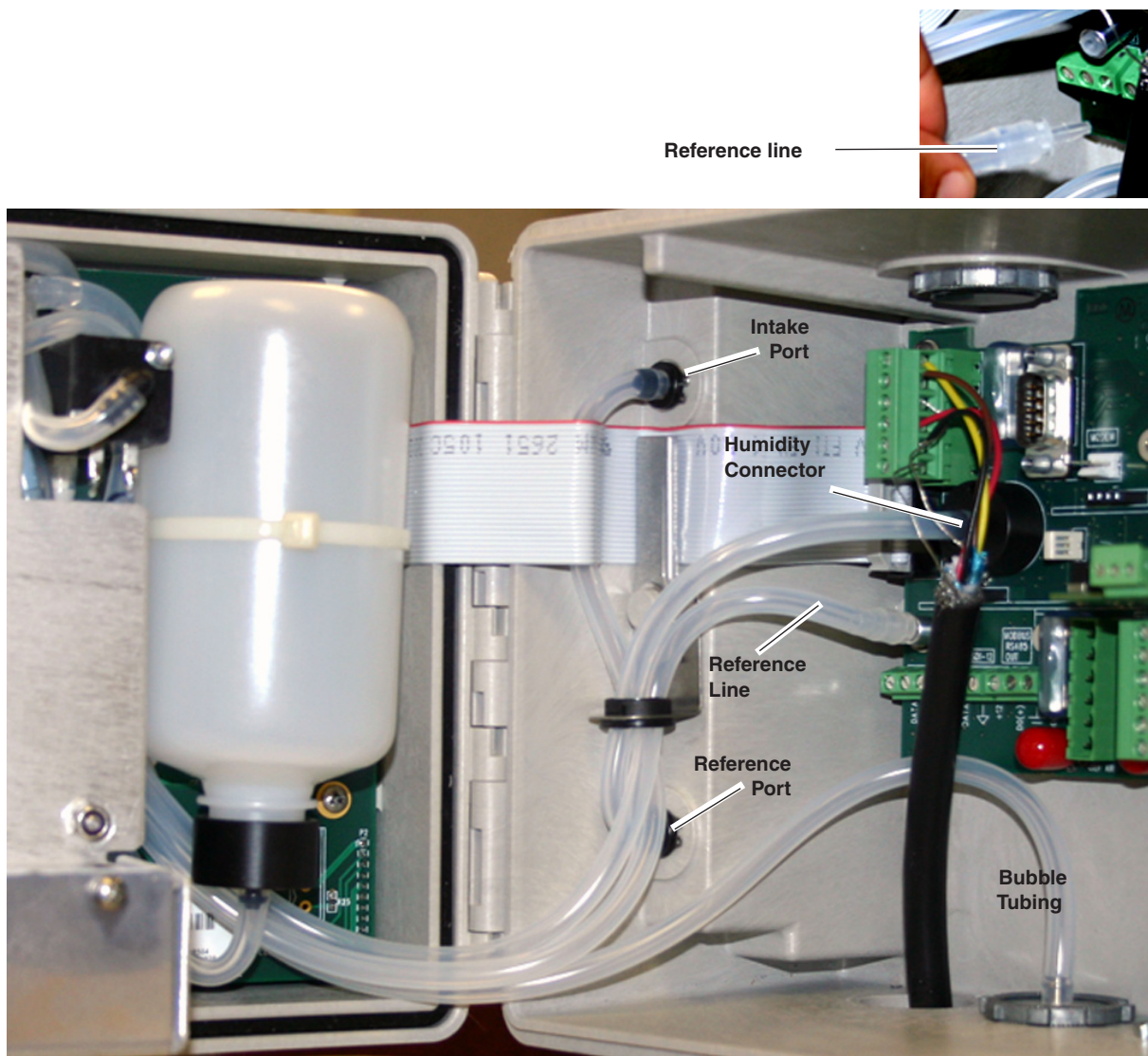


Figure 6-11 Routing and connections of 330 bubbler tubing

6.7 Front Cover Replacement

A replacement front cover (door) comes with latches attached, and two new hinge pins.

Align the hinges of the front cover front panel. Press the pins into the hinge barrels, with each flange facing inward (refer to Figure 6-12), until it is flush against the hinge surface.

Using a vice grip or other tool, spread and flatten the outward facing ends of the pins so they cannot be removed from the hinges.

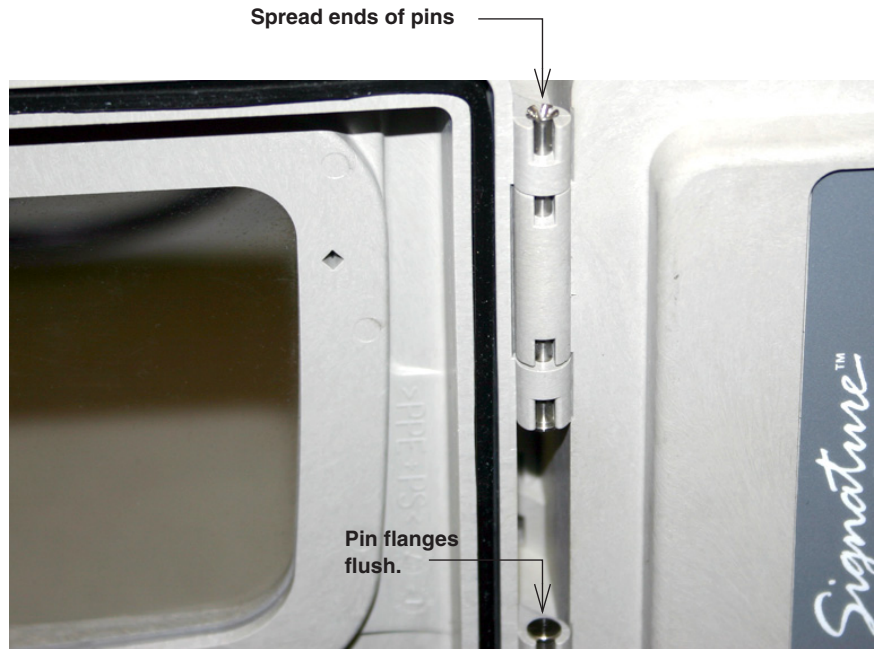


Figure 6-12 Front cover (door) replacement

6.8 System Reset

In the event that the Signature Flow Meter becomes unresponsive, operation may be restored by removing and then restoring line power.

If the problem persists, operation may be restored by performing a hard reset.

CAUTION

A hard reset erases site data and restores the program to factory default settings.

To perform a hard reset, first remove line power and any external battery power and wait 30 seconds. Then, while holding down both the Home key and the Delete key, restore line power.

6.9 Service and Repair

Service tasks described in this manual may be performed on site by properly trained personnel. Other service and repairs must be performed at the factory. If your Teledyne Isco equipment requires repair, contact Teledyne Isco technical support.

Teledyne Isco

Technical Service Dept.
P.O. Box 82531
Lincoln, NE 68501 USA

Phone:866 298-6174
402 464-0231
FAX:402 465-3085

E-mail:
IscoService@teledyne.com

Speaking with a Teledyne Isco Technical Service representative can often resolve the problem without the need to return the item. If the issue cannot be resolved by phone or email, you will receive a Return Authorization Number (RAN) and information on returning the equipment to the factory.

Signature® Flow Meter

Appendix A Replacement Parts

Replacement parts are called out in illustrations in this section. Reference the call-outs in the accompanying tables to determine the part number for the item.

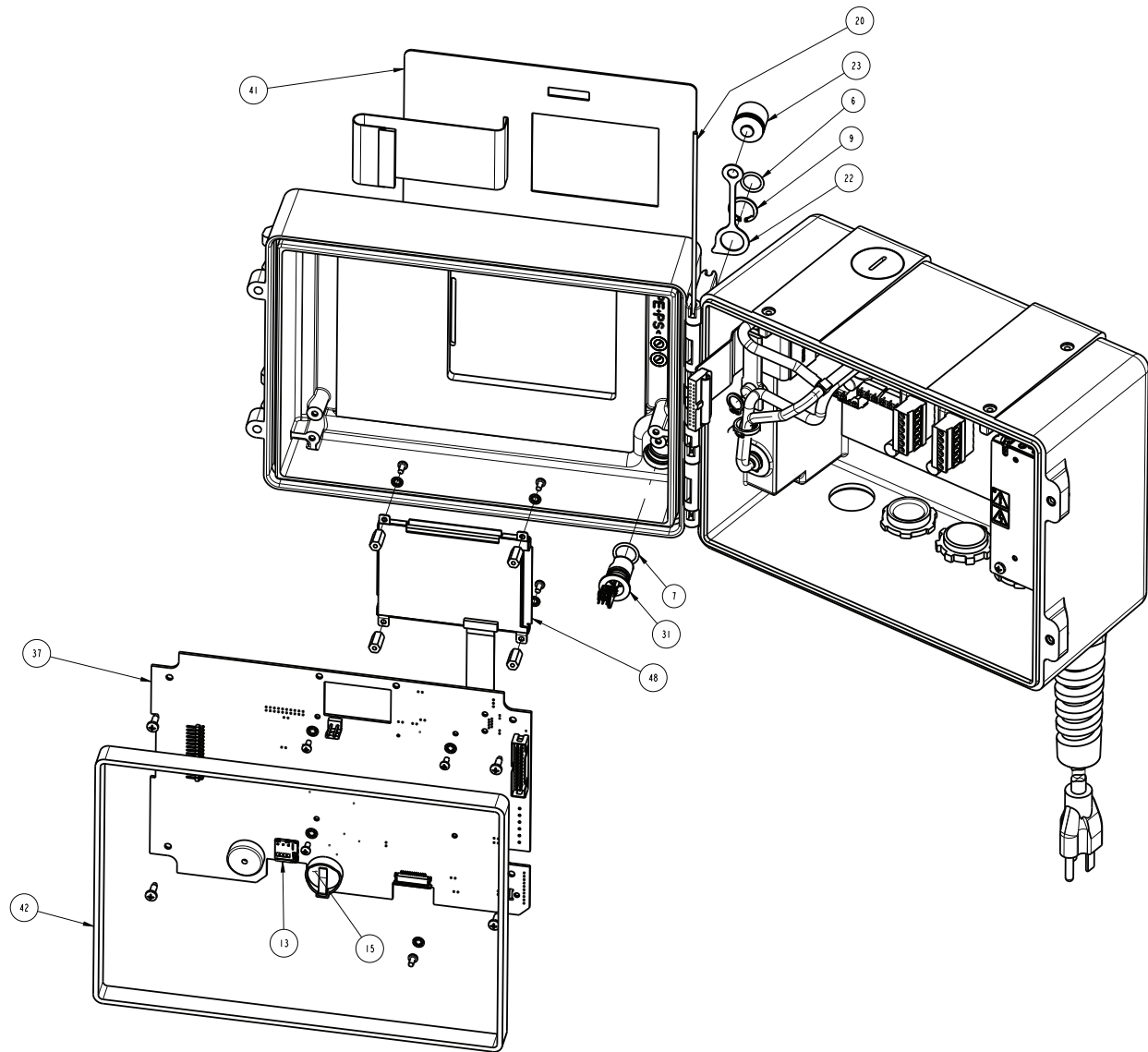
A.1 How to Order

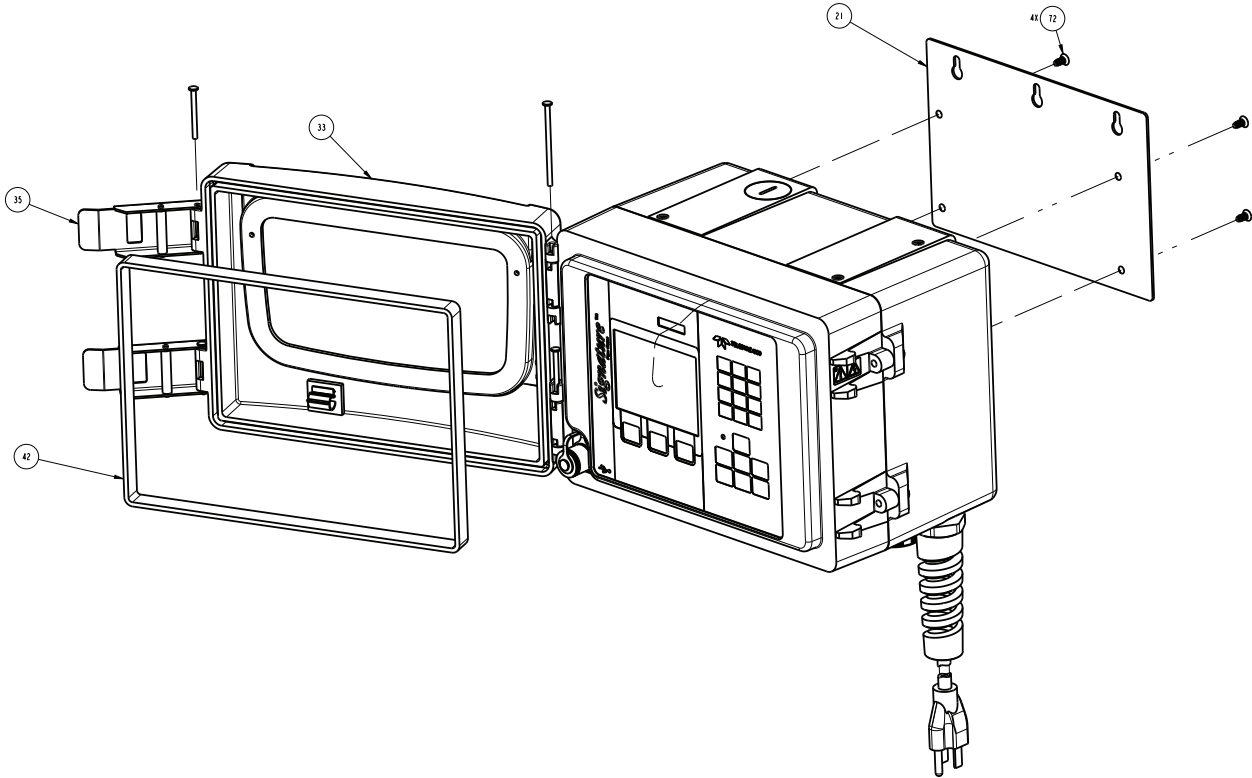
Replacement parts can be purchased by contacting Teledyne Isco's Customer Service Department.

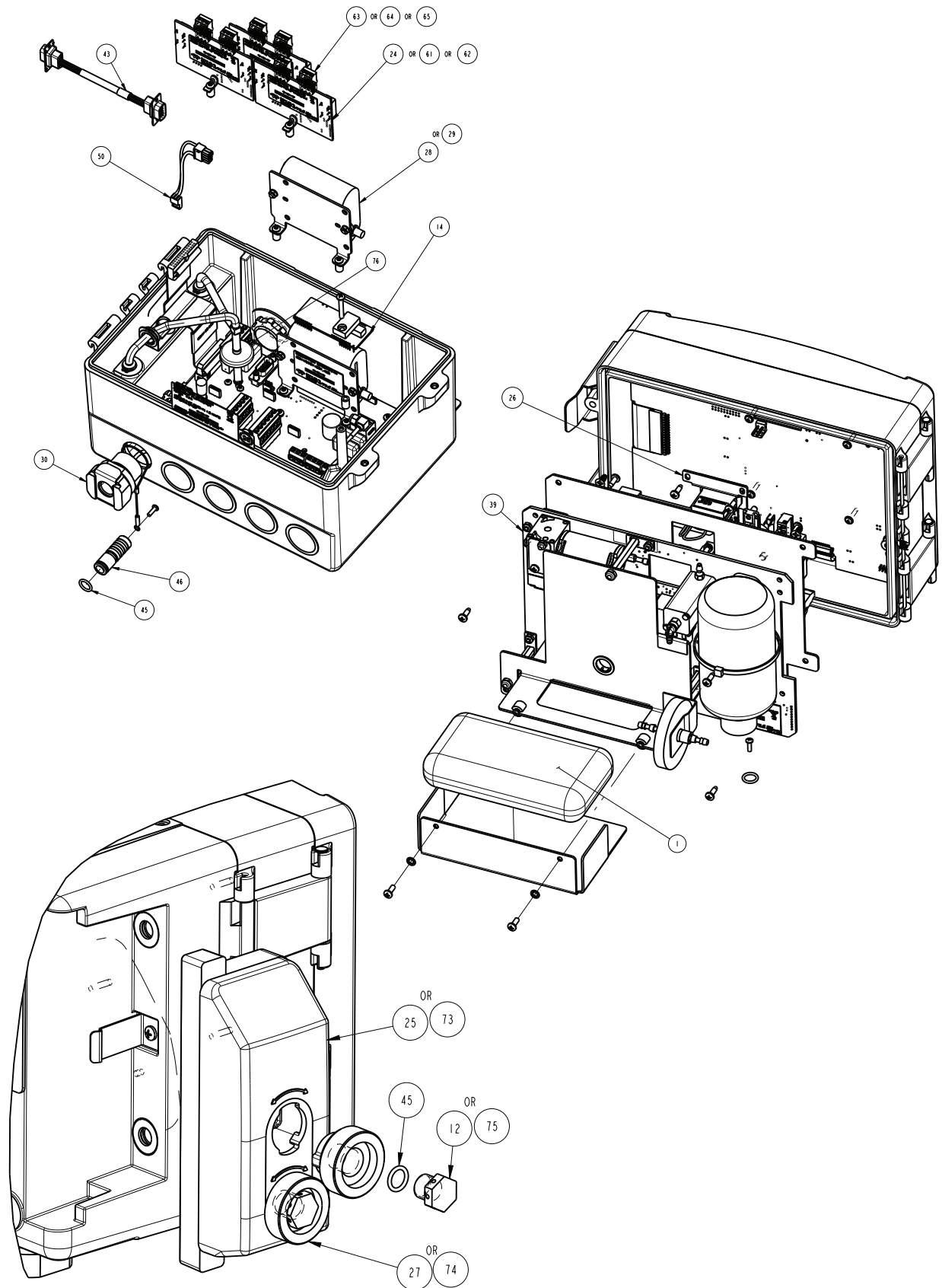
Teledyne Isco
Customer Service Dept.
P.O. Box 82531
Lincoln, NE 68501 USA

Phone: 800 228-4373
402 464-0231
FAX: 402 465-3022

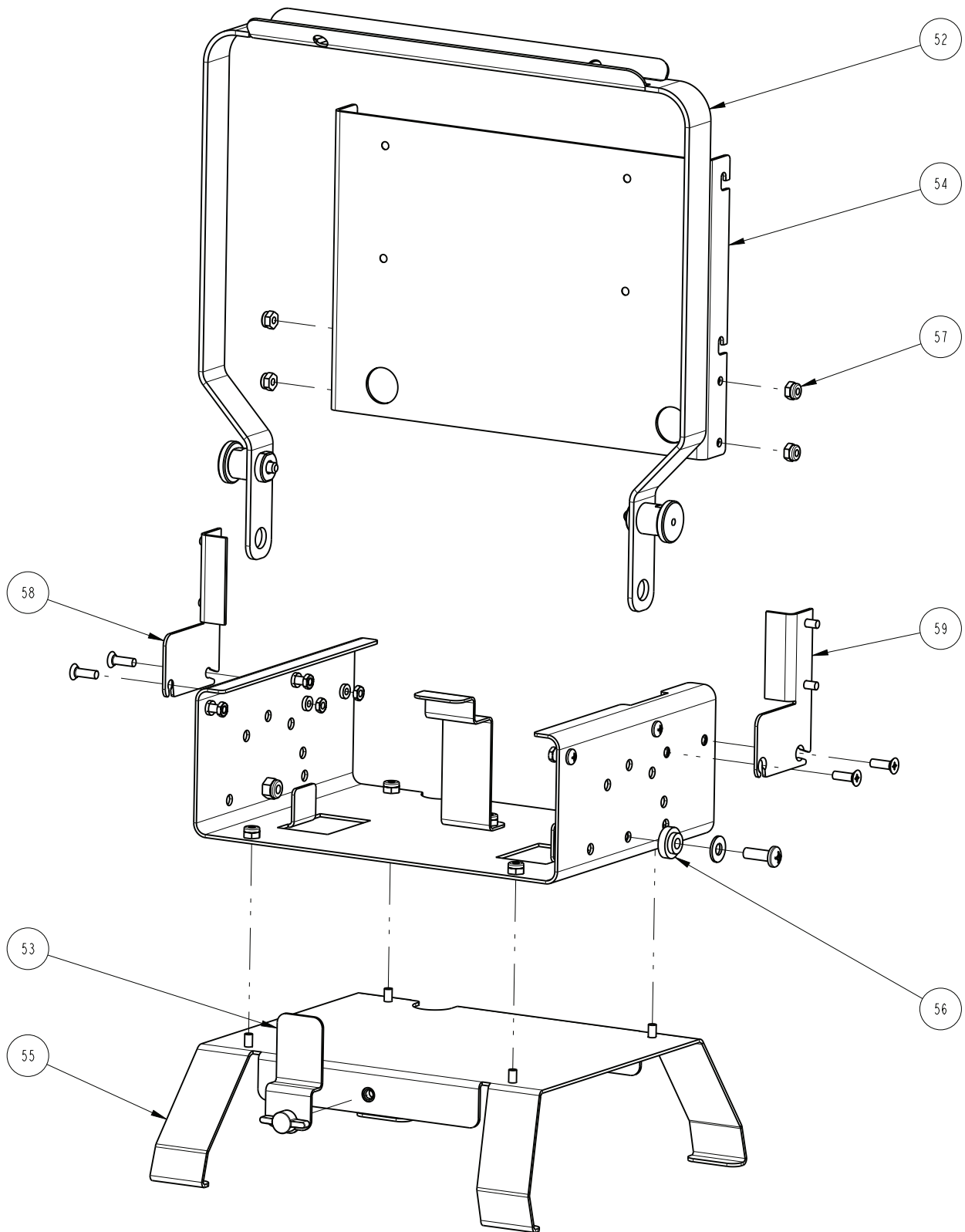
E-mail: IscoInfo@teledyne.com

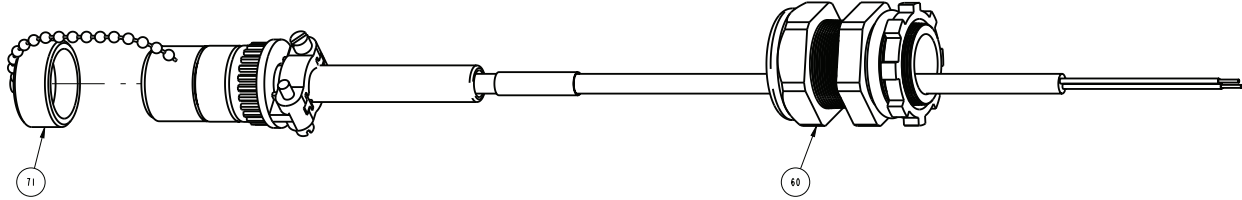
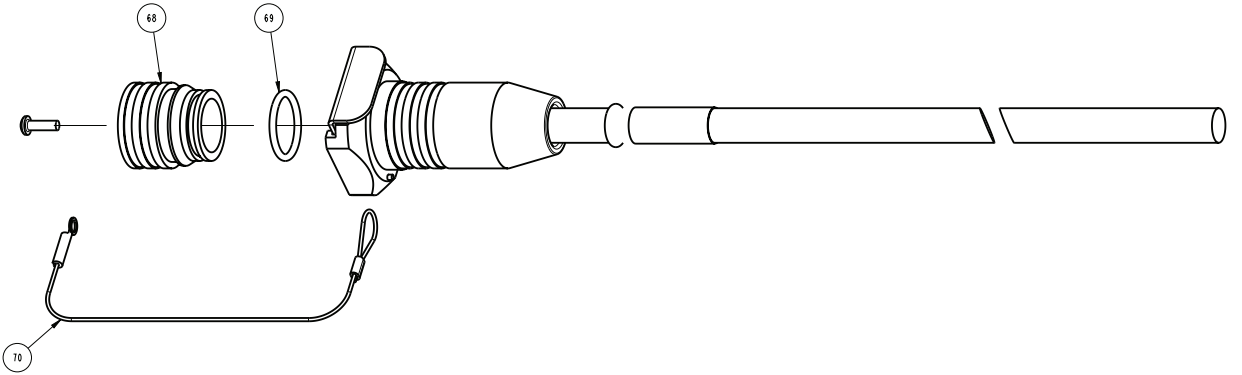






REPLACEMENT PARTS LIST		604302038
TELEDYNE ISCO		SHEET: 8 OF 12
ITEM NO.	PART NUMBER	DESCRIPTION
1	099000200	DESICCANT 8OZ BAG
12*	209009393	SCREW-IN HYDROPHOBIC FILTER
14	250300067	10/100 BASE T ETHERNET MODEM
24	604304006	ANALOG OUTPUT CARD ASSEMBLY
25*	604354019	DESICCATOR ASSEMBLY W/ DESICCANT
26	604304015	COUNTER ASSEMBLY
27*	604304016	DESICCANT CAP ASSEMBLY
28	604304100	CDMA MODEM ASSEMBLY
29	604304101	GSM MODEM ASSEMBLY
30	604304027	COAX CABLE AND CLIP ASSEMBLY
39	604334003	BUBBLER MODULE ASSEMBLY
43	694304028	SERIAL CABLE ASSEMBLY (CDMA & GSM)
45	202307012	O-RING .364ID .070
46	602003568	PLUG FEMALE ANTENNA
50	602004530	8 PIN POWER CABLE ASSEMBLY
51	602004233	SILICA GEL DESICCANT BOTTLE (NOT SHOWN)
61	604304069	CONTACT OUPUT CARD ASSEMBLY
62	604304054	ANALOG INPUT CARD ASSEMBLY
63	604304083	3 PIN CONNECTOR ANALOG IN
64	604304084	3 PIN CONNECTOR CONTACT OUT
65	604304085	3 PIN CONNECTOR ANALOG OUT
73	604304092	DESICCATOR ASSEMBLY W/ DESICCANT
74	604304090	ASSEMBLY DESICCANT CAP
75	604303130	DESICCANT PLUG
76	209009225	INLN AIR FILTER
*	USE ONLY W/ SIGNATURE METER S/N LOWER THAN 215D03048	
NOTE: 1. For current prices and quotations on parts, contact Teledyne Isco Service Department. 2. This list is subject to change without notice.		





Signature® Flow Meter

Appendix B Options and Accessories

B.1 Ordering Information Options and accessories can be purchased by contacting Teledyne Isco's Customer Service Department.

Teledyne Isco
Customer Service Dept.
P.O. Box 82531
Lincoln, NE 68501 USA

Phone: 800 228-4373
402 464-0231
FAX: 402 465-3022

E-mail: IscoInfo@teledyne.com

Note

For options and accessories exclusive to the external TIENet devices, refer to the appropriate TIENet user manuals (found at www.isco.com and listed in Section B.6 *Manuals*).

B.2 Signature Flow Meter Accessories

Cord grip fitting for TIENet cable	209-0073-12
<i>³/₄" NPT .375/.437" OD</i>	
Cord grip fitting for Battery backup cable	209-0073-11
<i>³/₄" NPT .250/.375" OD</i>	
Cord grip fitting with flexible strain protection	60-4307-022
Cord grip fitting for rain gauge and option card circuits, 3 hole	60-4304-080
Exterior desiccator - Required for use with 330 and 350 TIENet devices.....	60-4304-092
Silica gel desiccant, 1.5-lb container	099-0011-03
Model 674 rain gauge connect cable for Signature.....	60-4304-055
TIENet connection cable for Signature	60-4304-056
TIENet connection cable for Signature, cut to length	60-4304-068
TIENet 'Y' connection cable	60-4304-066
TIENet Header 6 screw clamp plug	69-4303-102
Analog Output 3 screw clamp header clip.....	60-4304-085
Analog Input 3 screw clamp header clip	60-4304-083
Contact Output 3 screw clamp header clip	60-4304-084
Power Supply Assembly with wiring harness.....	60-4304-037
TIENet Expansion Box w/ 10 ft cable.....	60-4307-023
TIENet Expansion Box w/ 10 ft cable and reference air support.....	60-4357-018
Bulk TIENet Cable, cut to Length	60-4304-050
USB Flash drive, 2GB.....	250-3000-42

Adaptor cable, USB Micro to USB-A.....	480-2946-02
USB connect cable, Signature to PC	480-2946-01
USB Flash drive, 2GB	250-3000-42
Option wire 3Conductor 22 GA (use with 604304080).....	480-1446-01
ProHanger SST Suspension bracket for 18 - 24in. manhole shaft	69-2003-599
Spreader bar for suspension of sensor or flow meter in manhole shaft	60-3004-110
Suspension harness	60-1704-016
7-Digit, non-resettable mechanical totalize	60-4304-015
Portable Stand Assembly	60-4304-079
Cord Grip 3-Hole for option wiring.....	60-4304-080
Rain Gauge 0.1in.....	60-3284-001
Rain Gauge 0.1 mm	60-3284-006
Model 674 rain gauge connect cable for Signature.....	60-4304-055
Reference port tubing kit	60-4307-017
8oz. Desiccant bag	099-0002-00
Gore Filter.....	209-0093-93
External Desiccator Assembly	60-4304-092

B.3 Power Accessories

Battery Backup: 946 Lead-acid battery pack, connect cable, and battery mounting hardware.....	60-4307-015
DC Power Cable with cord grip	60-4304-086
117V Power cord kit	60-4304-044
<i>Includes strain relief cord-grip fitting</i>	
117V Power cord.....	60-1683-216
240V Power cord kit	60-4304-045
<i>Includes strain relief cord-grip fitting</i>	
240V Power cord.....	48-0124-101
946 Lead Acid Battery	60-3004-106
948 Lead Acid Battery 45A-H	68-3000-948
948 Batttery Charger 12V 6A.....	34-1011-812
913 Power Pack 117V.....	60-1684-088
914 Power Pack w/ Battery Backup 117 V	68-3004-130
923 Power Pack 240V.....	68-3004-190
924 Power Pack w/ Battery Backup 240 V	68-3004-160
Cord grip w/protection	60-4307-022
965 Battery Charger 5 station 117V.....	68-3000-965
966 Battery Charger 5 station 117V	68-3000-966
963 Battery Charger 1 station 117/240V	68-3004-198

Signature Power Loss Alarm Box	60-5324-024
<i>Contact the Teledyne Isco Special Product Applications department for ordering information</i>	
240V Power cord	48-0124-101

B.4 TIENet Accessories

B.4.1 Internal to Signature

Analog Output Option Card.....	60-4304-006
Analog Input Option Card	60-4304-054
Contact Output Card	60-4304-069

B.4.2 Sensor and Cabling

TIENet connection cable for Signature	60-4304-056
TIENet connection cable for Signature, cut to length	60-4304-068
CA Assembly TIENet Y w/ connector	60-4304-066
TIENet Expansion Box (includes 10 ft TIENet cable and 2 cord grips).....	60-4307-023
TIENet Expansion Box with reference line support	60-4357-018
Cord grip fitting, 3/4" NPT, for TIENet cable	209-0073-12
Bulk TIENet Cable, cut-to-length, order by the foot	60-4304-050

B.4.3 301 pH/Temperature Device with Signature Connection Ending in Unterminated Leads

For use with Signature 6 position plug-in (green) terminal strip.

Includes cord grip, combination pH probe with built-in exposed temperature probe and 25 ft. probe cable, and one package of each buffer and rinse solution for probe calibration.

10 m cable*	60-4307-018
23 m cable*	60-4307-019
Cut-to-length cable*	60-4307-025

*Cable lengths from Signature to TIENet 301 device

B.4.4 301 pH/Temperature Device with Signature Connection Ending in TIENet Plug

For use with portable Signature TIENet receptacle.

Includes combination pH probe with built-in exposed temperature probe and 25 ft. probe cable and one package of each buffer and rinse solution for probe calibration

10 m cable*	60-4307-070
23 m cable*	60-4307-071
Cut-to-length cable*	60-4307-072

*Cable lengths from Signature to TIENet 301 device

B.4.5 306 Sampler Interface Cable with Signature Connection Ending in Unterminated Leads **For use with Signature 6 position plug-in (green) terminal strip.**
Includes cord grip and sensor with cable. (See cable lengths below).

306 Sampler Interface w/ 10 m (32.8 ft) cable	60-4304-007
306 Sampler Interface w/ 23 m (75 ft) cable	60-4304-008
306 Sampler Interface w/ CTL cable	60-4304-088
Assembly Model 306 5m (5800/4700 OLNy)	60-5804-178
Assembly Model 306 10m (5800/4700 OLNy)	60-5804-179
Assembly Model 306 23m (5800/4700 OLNy)	60-5804-180

B.4.6 306 Sampler Interface Cable with Signature Connection Ending in TIENet Plug. **For use with portable Signature TIENet receptacle.**

306 Sampler Interface w/ connector and 10m (32.8 ft) cable	60-4304-076
306 Sampler Interface w/ connector and 23 m (75 ft) cable	60-4304-077
306 Sampler Interface w/ connector and CTL cable	60-4304-078
4700/5800 Sampler Interface cable	60-5314-697

B.4.7 310 Ex Ultrasonic Level Sensor with Signature Connection Ending in Unterminated Leads. **For use with Signature 6 position plug-in (green) terminal strip.**
Includes cord grip and sensor with cable. (See cable lengths below).

310 Ultrasonic sensor w/ 10m cable	60-4314-005
310 Ultrasonic sensor w/ 23m cable	60-4314-006
310 Ultrasonic sensor Cut-to-length*	60-4314-014

. *Cable lengths can go up to 150 m with an expansion box.

B.4.8 310 Ex Ultrasonic Level Sensor with Signature Connection Ending in TIENet Plug. **For use with portable Signature TIENet receptacle.**
Includes cord grip and sensor with cable. (See cable lengths below).

310 Ultrasonic sensor w/ connector and 10m cable	60-4314-009
310 Ultrasonic sensor w/ connector and 23m cable	60-4314-011
310 Ultrasonic sensor w/ connector Cut-to-length*	60-4314-013

*Cable lengths can go up to 150 m with an expansion box.

B.4.9 350 Area Velocity Sensor with Signature Connection Ending in Unterminated Leads **For use with Signature 6 position plug-in (green) terminal strip.**
Includes cord grip and sensor with cable (See cable lengths below).

350 Area Velocity sensor w/ 10m cable	60-4354-113
350 Area Velocity sensor w/ 23m cable	60-4354-114

350 Area Velocity sensor w/ Cut-to-length*	60-4354-126
*Cable lengths can go up to 150 m with an expansion box.	

**B.4.10 350 Area Velocity
sensor with Signature
Connection Ending in
TIENet Plug**

For use with portable Signature TIENet receptacle.
*Includes sensor with cable and connector (See cable lengths
below).*

350 Area Velocity sensor w/ connector and 10m cable	60-4354-123
350 Area Velocity sensor w/ connector and 23m cable	60-4354-124
350 Area Velocity sensor w/ connector Cut-to-length*	60-4354-125
*Cable lengths can go up to 150 m with an expansion box.	

B.5 Modems

CDMA Digital cellular modem (Cellular service not included.)	60-4307-100
GSM Digital cellular modem (Global) (Cellular service not included.)	60-4307-101
LTE Digital cellular modem (Cellular service not included.)	60-4307-102
Magnetic mount antenna for CDMA, GSM, LTE	60-4804-035
Ethernet modem	60-4307-016

B.6 Manuals

Signature Flow Meter	69-4303-070
Signature Bubbler Flow Meter	69-4333-004
TIENet 301 pH/Temperature Device	69-4303-071
TIENet 306 Sampler Interface	69-4303-072
TIENet 310 Ultrasonic Sensor	69-4313-010
TIENet 350 Area Velocity Sensor	69-4353-024
TIENet 360 LaserFlow Sensor	69-4363-043
Mounting Rings	60-3203-061
Flow Metering Insert	60-3234-064
Flowlink 5.1 Software	69-2543-213
Isco Open Channel Flow Measurement Handbook, 6th Ed.	60-3003-041

B.7 Sensor Mounting Rings

B.7.1 Spring Rings

Probe Mounting Ring for 6" pipe	68-3200-007
Probe Mounting Ring for 8" pipe	68-3200-008
Probe Mounting Ring for 10" pipe	68-3200-009
Probe Mounting Ring for 12" pipe	68-3200-010
Probe Mounting Ring for 15" pipe	68-3200-011

B.7.2 Scissor Rings

Base Section (with tabs for mounting up to five probes)	60-3004-169
Scissors Assembly	60-3004-170
Extension 1 (9.0")	60-3004-172
Extension 2 (21.5")	60-3004-173

Extension 3 (31.5")	60-3004-174
Extension 4 (41.5")	60-3004-175
16-24" Pipe ID	68-3000-042
26-38" Pipe ID	68-3000-043
38-44" Pipe ID	68-3000-044
44-48" Pipe ID	68-3000-045
60" Pipe ID	68-3000-046
72" Pipe ID	68-3000-047
16-60" Pipe ID	68-3000-048
Base Section (with plastic ties and manual)	60-3004-169

Note

Scissor Mounting Ring Assemblies will require a base and scissors section for all sizes. Each scissors ring includes a base section, scissors mechanism, extensions, plastic ties, and a manual). Sizes from 16" to 80" will also require two or more extension sections.

Signature® Flow Meter

Appendix C Modbus Output Protocol

Sections C.1 through C.3 give an overview of the basic capabilities and operation of Modbus output protocol as it applies to the Isco Signature Flow Meter.

For a Glossary of Terms and Common Acronyms, see Section C.4.

C.1 Introduction

Modbus is a simple command/response mechanism to read from and write to specific memory locations called *registers*. A register is a holding place for a piece of digital information within the equipment. The Signature uses Modbus ASCII and Modbus RTU protocols, providing a standard protocol for real-time data retrieval. The data can be sent to a central computer for display, data collection, or process control. Modbus cannot be used to retrieve historical data from the Signature's memory.

This section describes the overall capabilities and operation of Modbus.

C.2 Operation

There are many standard, third party Modbus drivers and OPC servers that may be used to link a remote Modbus device, such as the Signature Flow Meter, to SCADA or process control software, such as Wonderware®¹ or Intellution®². The OPC server communicates with the flow meter and accesses registers. The definition of what information is contained and where (the register number, or address) is set by Teledyne Isco.

The Signature register addresses, and what parameters are held where, are available in Table C-1 in Section C.6.1.

By accessing these registers you can obtain the current value of whatever parameter you desire. The reading(s) can then be displayed or stored wherever you designate as a destination; for example, a process control computer.

Not all registers are limited to read-only data storage. You can also use two of the registers for control purposes. For example, writing a "1" value to register 25 ("TakeReadingFlag" register), tells the Signature to update its readings.

1. Wonderware® is a registered trademark of Wonderware Software Development Corporation.

2. Intellution® is a registered trademark of Intellution, Inc.

C.3 Configurations

A variety of configurations can be made with Modbus, either through direct connection or through a modem.

In the example shown in Figure C-1, you are direct-connecting a server PC to two individual Signature sites through Modbus, using the COM ports on the OPC Server, which are directly connected to the remote sites.

Connection to the flow meter is made via the RS-485 terminal on the Signature case board (refer to Figure 3-2 *Connector case, connectors, and fuses*).

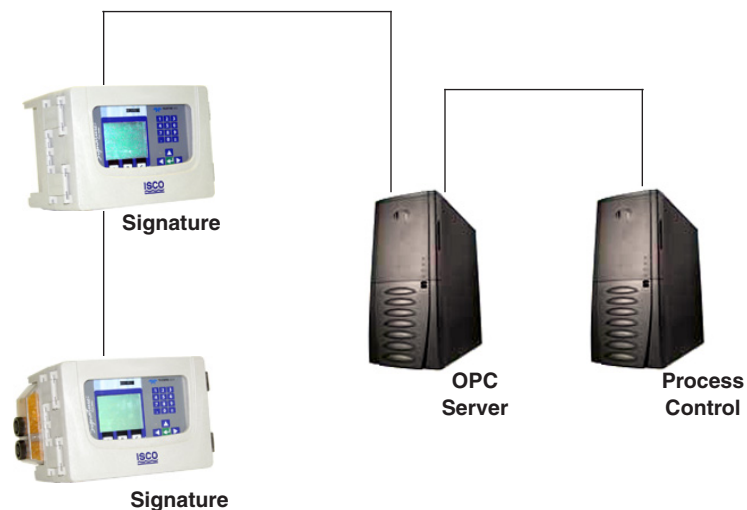


Figure C-1 Configuration example

The operation sequence for the example above can be summarized in the following steps:

1. Signatures take readings from sensors.
2. Signatures store readings (level, velocity, flow rate, etc.) in their specified registers.
3. The user requests data through Process Control.
4. Process Control asks the OPC server to gather information.
5. OPC connects to the specified Signature flow meter through the cable (direct connection), retrieves site data and populates the OPC server's holding index.
6. Process Control takes the data from the OPC server's holding index and gives the data to the user.

Note that Process Control can be either manual or automated in this example, and that the OPC server and Process Control may be located physically on the same computer.

C.4 Glossary of Terms

Address – An address is a digital location specified for a device (such as the Signature Flow Meter).

ASCII – Short for American Standard Code for Information Interchange, ASCII is a code that represents English characters with numbers. Most computers represent text with ASCII code, making it possible for one computer or device to share data with another.

DCS – Distributed Control Systems

Dedicated Line – A telecommunications path reserved for communication between two specified points and not shared among multiple points.

Modbus Protocol – Modbus Protocol is a messaging structure used to establish master-slave/client server communications between intelligent devices. Modbus is a simple command/response mechanism to read from and write to registers.

MTU – Master Terminal Unit

OPC – OPC (OLE for Process Control) means open connectivity via open (free for use) standards. It is a series of software standards specifications that fill a need in automation (like printer drivers did for Windows), acting as a translator for data transmission and process control.

The specification defines a standard set of objects, interfaces, and methods for use in process control and manufacturing automation applications to facilitate interoperability. There are hundreds of OPC Data Access servers and clients.

PLC – Programmable Logic Controller

Registers – A register is a location in memory for a specific data type. The definition of what data is contained and where (the registry number, or address) is set by the equipment manufacturer (in this case Teledyne Isco).

RTU – Short for Remote Terminal Unit (or Remote Telemetry Unit), RTU is a code that represents data using a compact binary format.

SCADA – SCADA (Supervisory Control And Data Acquisition) is a computer system for gathering and analyzing real-time data. SCADA systems are used to monitor and control plant operation, or equipment in industries.

The SCADA system transfers the information (for example, where a leak has occurred in a pipeline), back to a central site, alerting the home station of the leak, performing necessary analysis and control (such as determining if the leak is critical), and displaying the information in a logical and organized manner.

SCADA systems can be relatively simple, such as one that monitors the environmental conditions of a small office building, or very complex, such as a system that monitors all the activity in a nuclear power plant or a municipal water system.

TCP/IP – Transmission Control Protocol/Internet Protocol

C.5 Signature ASCII or RTU Address

The Signature's address (Device ID) is user-programmable between 2 and 247.

CAUTION

Be careful not to assign the same address to more than one flow meter.

C.6 Register Definitions

The register definitions for the Signature flow meter are provided in the following table.

Where no other Unit Of Measure exists for a parameter, percent (%) can be used in most situations.

C.6.1 Modbus Registers

Table C-1 Modbus Output Registers for Signature Flow Meter

Register Number	Name	Data Type	Units of Measure	Read/Write	Description
40025	TakeReadingFlag	Word		R/W	Set to 1 to update readings, 2 for automatic update
40026	UpdateInterval	Word	Seconds	R/W	The reading update interval in seconds
40027	Activeflags	Word		R	The bit fields to indicate which sensors are active
40040 40041	Level	Float	Meters	R	Level
40042	Levelstatus	Word		R	The level status - non-zero is an error
40043 - 48	Leveltime	Word		R	The last level reading time, sec-min-hour-day-month-year
40055 40056	Level1	Float	Meters	R	Level 1
40057	Level1status	Word		R	The level 1 status - non-zero is an error
40058 - 63	Level1time	Word		R	The last level 1 reading time, sec-min-hour-day-month-year
40070 40071	Level2	Float	Meters	R	Level 2
40072	Level2status	Word		R	The level 2 status - non-zero is an error
40073 - 78	Level2time	Word		R	The last level 2 reading time, sec-min-hour-day-month-year
40085 40086	Level3	Float	Meters	R	Level 3
40087	Level3status	Word		R	The level 3 status - non-zero is an error
40088 - 93	Level3time	Word		R	The last level 3 reading time, sec-min-hour-day-month-year
40100 40101	Velocity	Float	Meters/Sec	R	Velocity

Table C-1 Modbus Output Registers for Signature Flow Meter

Register Number	Name	Data Type	Units of Measure	Read/Write	Description
40102	Velocitystatus	Word		R	0 = Good, 1 = Failed to Measure, 4 = below min Depth
40103 - 08	Velocitytime	Word		R	The last velocity reading time, sec-min-hour-day-month-year
40115 40116	Velocity1	Float	Meters/Sec	R	Velocity 1
40117	Velocity1status	Word		R	0 = Good, 1 = Failed to Measure, 4 = below min Depth
40118 - 23	Velocity1time	Word		R	The last velocity 1 reading time, sec-min-hour-day-month-year
40130 40131	Velocity2	Float	Meters/Sec	R	Velocity 2
40132	Velocity2status	Word		R	0 = Good, 1 = Failed to Measure, 4 = below min Depth
40133 - 38	Velocity2time	Word		R	The last velocity 2 reading time, sec-min-hour-day-month-year
40145 40146	Velocity3	Float	Meters/Sec	R	Velocity 3
40147	Velocity3status	Word		R	0 = Good, 1 = Failed to Measure, 4 = below min Depth
40148 - 53	Velocity3time	Word		R	The last velocity 3 reading time, sec-min-hour-day-month-year
40160 40161	Flowrate	Float	Cubic Meters/Sec	R	Flow rate
40162	Flowratestatus	Word		R	The flow rate status - non-zero is an error
40163 - 68	Flowratetime	Word		R	The last flow rate reading time, sec-min-hour-day-month-year
40175 40176	Flowrate1	Float	Cubic Meters/Sec	R	Flow rate 1
40177	Flowrate1status	Word		R	The flow rate 1 status - non-zero is an error
40178 - 83	Flowrate1time	Word		R	The last flow rate1 reading time, sec-min-hour-day-month-year
40190 40191	Flowrate2	Float	Cubic Meters/Sec	R	Flow rate 2
40192	Flowrate2status	Word		R	The flow rate 2 status - non-zero is an error
40193 - 98	Flowrate2time	Word		R	The last flow rate 2 reading time, sec-min-hour-day-month-year
40205 40206	Flowrate3	Float	Cubic Meters/Sec	R	Flow rate 3
40207	Flowrate3status	Word		R	The flow rate 3 status - non-zero is an error
40208 - 13	Flowrate3time	Word		R	The last flow rate 3 reading time, sec-min-hour-day-month-year

Table C-1 Modbus Output Registers for Signature Flow Meter

Register Number	Name	Data Type	Units of Measure	Read/Write	Description
40220 40221	Temperature	Float	Degrees Celsius	R	Temperature
40222	Temperaturestatus	Word		R	The temperature status - non-zero is an error
40223 - 28	Temperaturetime	Word		R	The last temperature reading time, sec-min-hour-day-month-year
40235 40236	Temperature1	Float	Degrees Celsius	R	Temperature 1
40237	Temperature1status	Word		R	The temperature 1 status - non-zero is an error
40238 - 43	Temperature1time	Word		R	The last temperature 1 reading time, sec-min-hour-day-month-year
40250 40251	Temperature2	Float	Degrees Celsius	R	Temperature 2
40252	Temperature2status	Word		R	The temperature 2 status - non-zero is an error
40253 - 58	Temperature2time	Word		R	The last temperature reading time, sec-min-hour-day-month-year
40265 40266	Temperature3	Float	Degrees Celsius	R	Temperature 3
40267	Temperature3status	Word		R	The temperature 3 status - non-zero is an error
40268 - 73	Temperature3time	Word		R	The last temperature 3 reading time, sec-min-hour-day-month-year
40280 40281	Volume	Float	Cubic Meters	R	Volume
40282	Volumestatus	Word		R	The volume status - non-zero is an error
40283 - 88	Volumetime	Word		R	The last volume reading time, sec-min-hour-day-month-year
40295 40296	Volume1	Float	Cubic Meters	R	Volume 1
40297	Volume1status	Word		R	The volume 1 status - non-zero is an error
40298 - 303	Volume1time	Word		R	The last volume 1 reading time, sec-min-hour-day-month-year
40310 40311	Volume2	Float	Cubic Meters	R	Volume 2
40312	Volume2status	Word		R	The volume 2 status - non-zero is an error
40313 - 18	Volume2time	Word		R	The last volume 2 reading time, sec-min-hour-day-month-year
40325 40326	Volume3	Float	Cubic Meters	R	Volume 3
40327	Volume3status	Word		R	The volume 3 status - non-zero is an error
40328 - 33	Volume3time	Word		R	The last volume 3 reading time, sec-min-hour-day-month-year
40340 40341	Voltage	Float	Volts	R	Voltage

Table C-1 Modbus Output Registers for Signature Flow Meter

Register Number	Name	Data Type	Units of Measure	Read/Write	Description
40342	Voltagestatus	Word		R	The voltage status - non-zero is an error
40343 - 48	Voltage1time	Word		R	The last voltage reading time, sec-min-hour-day-month-year
40355 40356	Voltage1	Float	Volts	R	Voltage 1
40357	Voltage1status	Word		R	The voltage 1 status - non-zero is an error
40358 - 63	Voltage1time	Word		R	The last voltage 1 reading time, sec-min-hour-day-month-year
40370 40371	Voltage2	Float	Volts	R	Voltage 2
40372	Voltage2status	Word		R	The voltage 2 status - non-zero is an error
40373 - 78	Voltage2time	Word		R	The last voltage 2 reading time, sec-min-hour-day-month-year
40385 40386	Voltage3	Float	Volts	R	Voltage 3
40387	Voltage3status	Word		R	The voltage 3 status - non-zero is an error
40388 - 93	Voltage3time	Word		R	The last voltage 3 reading time, sec-min-hour-day-month-year
40400 40401	Analog/%	Float	4-20mA/ 0-100%	R	Analog output or percentage
40402	Analog/status	Word		R	The Analog output or percentage status - non-zero is an error
40403 - 08	Analog/time	Word		R	The last analog or percentage reading time, sec-min-hour-day-month-year
40415 40416	Analog/1	Float	4-20mA/ 0-100%	R	Analog 1 output or percentage
40417	Analog/1status	Word		R	The Analog 1 output or percentage status - non-zero is an error
40418 - 23	Analog/1time	Word		R	The last analog 1 or percentage reading time, sec-min-hour-day-month-year
40430 40431	Analog/2	Float	4-20mA/ 0-100%	R	Analog 2 output or percentage
40432	Analog/2status	Word		R	The Analog 2 output or percentage status - non-zero is an error
40433 - 38	Analog/2time	Word		R	The last analog 2 or percentage reading time, sec-min-hour-day-month-year
40445 40446	Analog/3	Float	4-20mA/ 0-100%	R	Analog 3 output or percentage
40447	Analog/3status	Word		R	The Analog 3 output or percentage status - non-zero is an error
40448 - 53	Analog/3time	Word		R	The last analog 3 or percentage reading time, sec-min-hour-day-month-year

Table C-1 Modbus Output Registers for Signature Flow Meter

Register Number	Name	Data Type	Units of Measure	Read/Write	Description
40460 40461	Analog/4	Float	4-20mA/ 0-100%	R	Analog 4 output or percentage
40462	Analog/4status	Word		R	The Analog 4 output or percentage status - non-zero is an error
40463 - 68	Analog/4time	Word		R	The last analog 4 or percentage reading time, sec-min-hour-day-month-year
40475 40476	Analog/5	Float	4-20mA/ 0-100%	R	Analog 5 output or percentage
40477	Analog/5status	Word		R	The Analog 5 output or percentage status - non-zero is an error
40478 - 83	Analog/5time	Word		R	The last analog 5 or percentage reading time, sec-min-hour-day-month-year
40490 40491	Analog/6	Float	4-20mA/ 0-100%	R	Analog 6 output or percentage
40492	Analog/6status	Word		R	The Analog 6 output or percentage status - non-zero is an error
40493 - 98	Analog/6time	Word		R	The last analog 6 or percentage reading time, sec-min-hour-day-month-year
40505 40506	Analog/7	Float	4-20mA/ 0-100%	R	Analog 7 output or percentage
40507	Analog/7status	Word		R	The Analog 7 output or percentage status - non-zero is an error
40508 - 13	Analog/7time	Word		R	The last analog 7 or percentage reading time, sec-min-hour-day-month-year
40520 40521	Analog/8	Float	4-20mA/ 0-100%	R	Analog 8 output or percentage
40522	Analog/8status	Word		R	The Analog 8 output or percentage status - non-zero is an error
40523 - 28	Analog/8time	Word		R	The last analog 8 or percentage reading time, sec-min-hour-day-month-year
40535 40536	Analog/9	Float	4-20mA/ 0-100%	R	Analog 9 output or percentage
40537	Analog/9status	Word		R	The Analog 9 output or percentage status - non-zero is an error
40538 - 43	Analog/9time	Word		R	The last analog 9 or percentage reading time, sec-min-hour-day-month-year
40550 40551	Analog/10	Float	4-20mA/ 0-100%	R	Analog 10 output or percentage
40552	Analog/10status	Word		R	The Analog 10 output or percentage status - non-zero is an error
40553 - 58	Analog/10time	Word		R	The last analog 10 or percentage reading time, sec-min-hour-day-month-year
40565 40566	Analog/11	Float	4-20mA/ 0-100%	R	Analog 11 output or percentage

Table C-1 Modbus Output Registers for Signature Flow Meter

Register Number	Name	Data Type	Units of Measure	Read/Write	Description
40567	Analog/11status	Word		R	The Analog 11 output or percentage status - non-zero is an error
40568 - 73	Analog/11time	Word		R	The last analog 11 or percentage reading time, sec-min-hour-day-month-year
40580 40581	Analog/12	Float	4-20mA/ 0-100%	R	Analog 12 output or percentage
40582	Analog/12status	Word		R	The Analog 12 output or percentage status - non-zero is an error
40583 - 88	Analog/12time	Word		R	The last analog 12 or percentage reading time, sec-min-hour-day-month-year
40595 40596	Analog/13	Float	4-20mA/ 0-100%	R	Analog 13 output or percentage
40597	Analog/13status	Word		R	The Analog 13 output or percentage status - non-zero is an error
40598 - 603	Analog/13time	Word		R	The last analog 13 or percentage reading time, sec-min-hour-day-month-year
40610 40611	Analog/14	Float	4-20mA/ 0-100%	R	Analog 14 output or percentage
40612	Analog/14status	Word		R	The Analog 14 output or percentage status - non-zero is an error
40613 - 18	Analog/14time	Word		R	The last analog 14 or percentage reading time, sec-min-hour-day-month-year
40625 40626	Analog/15	Float	4-20mA/ 0-100%	R	Analog 14 output or percentage
40627	Analog/15status	Word		R	The Analog 15 output or percentage status - non-zero is an error
40628 - 33	Analog/15time	Word		R	The last analog 15 or percentage reading time, sec-min-hour-day-month-year
40700 40701	Fluoresence	Float	%	R	
40702	Fluoresencestatus	Word		R	
40703	Fluoresencetime	Word		R	
40715 40716	Fluoresence1	Float	%	R	
40717	Fluoresence1status	Word		R	
40718 - 23	Fluoresence1time	Word		R	
40730 - 31	Fluoresence2	Float	%	R	
40732	Fluoresence2status	Word		R	
40733 - 38	Fluoresence2time	Word		R	
40745 - 46	Fluoresence3	Float	%	R	
40747	Fluoresence3status	Word		R	

Table C-1 Modbus Output Registers for Signature Flow Meter

Register Number	Name	Data Type	Units of Measure	Read/Write	Description
40748 - 53	Fluoresence3time	Word		R	
40760 40761	Battery	Float	Volts	R	
40762	Batterystatus	Word		R	
40763 - 68	Batterytime	Word		R	
40775 40776	Battery1	Float	Volts	R	
40777	Battery1status	Word		R	
40778 - 83	Battery1time	Word		R	
40790 40791	Battery2	Float	Volts	R	
40792	Battery2status	Word		R	
40793 - 98	Battery2time	Word		R	
40805 40806	Battery3	Float	Volts	R	
40807	Battery3status	Word		R	
40808 - 13	Battery3time	Word		R	
40820 40821	Dissolved Gas	Float	mmHg	R	
40822	Dissolved Gasstatus	Word		R	
40823 - 28	Dissolved Gastime	Word		R	
40835 40836	Dissolved Gas1	Float	mmHg	R	
40837	Dissolved Gas1status	Word		R	
40838 - 43	Dissolved Gas1time	Word		R	
40850 40851	Dissolved Gas2	Float	mmHg	R	
40852	Dissolved Gas2status	Word		R	
40853 - 58	Dissolved Gas2time	Word		R	
40865 40866	Dissolved Gas3	Float	mmHg	R	
40867	Dissolved Gas3status	Word		R	
40868 - 73	Dissolved Gas3time	Word		R	
40940 40941	Photosyn Rad	Float	umol s1 m2	R	
40942	Photosyn Radstatus	Word		R	
40943 - 48	Photosyn Radtime	Word		R	
40955 40956	Photosyn Rad1	Float	umol s1 m2	R	

Table C-1 Modbus Output Registers for Signature Flow Meter

Register Number	Name	Data Type	Units of Measure	Read/Write	Description
40957	Photosyn Rad1status	Word		R	
40958 - 63	Photosyn Rad1time	Word		R	
40970 40971	Photosyn Rad2	Float	umol s1 m2	R	
40972	Photosyn Rad2status	Word		R	
40973 - 78	Photosyn Rad2time	Word		R	
40985 40986	Photosyn Rad3	Float	umol s1 m2	R	
40987	Photosyn Rad3status	Word		R	
40988 - 93	Photosyn Rad3time	Word		R	
41000 41001	Transmissivity	Float	%	R	
41002	Transmissivitystatus	Word		R	
41003 - 08	Transmissivitytime	Word		R	
41015 41016	Transmissivity1	Float	%	R	
41017	Transmissivity1status	Word		R	
41018 - 23	Transmissivity1time	Word		R	
41030 41031	Transmissivity2	Float	%	R	
41032	Transmissivity2status	Word		R	
41033 - 38	Transmissivity2time	Word		R	
41045 41046	Transmissivity3	Float	%	R	
41047	Transmissivity3status	Word		R	
41048 - 53	Transmissivity3time	Word		R	
41060 41061	Conductivity	Float	uS/cm	R	
41062	Conductivitystatus	Word		R	
41063 - 68	Conductivitytime	Word		R	
41075 41076	Conductivity1	Float	uS/cm	R	
41077	Conductivity1status	Word		R	
41078 - 83	Conductivity1time	Word		R	
41090 41091	Conductivity2	Float	uS/cm	R	
41092	Conductivity2status	Word		R	
41093 - 98	Conductivity2time	Word		R	

Table C-1 Modbus Output Registers for Signature Flow Meter

Register Number	Name	Data Type	Units of Measure	Read/Write	Description
41105 41106	Conductivity3	Float	uS/cm	R	
41107	Conductivity3status	Word		R	
41108 - 13	Conductivity3time	Word		R	
41120 41121	Specific Conductance	Float	uS/cm	R	
41122	Specific Conductancestatus	Word		R	
41123 - 28	Specific Conductancetime	Word		R	
41135 41136	Specific Conductance1	Float	uS/cm	R	
41137	Specific Conductance1status	Word		R	
41138 - 43	Specific Conductance1time	Word		R	
41150 41151	Specific Conductance2	Float	uS/cm	R	
41152	Specific Conductance2status	Word		R	
41153 - 58	Specific Conductance2time	Word		R	
41165 41166	Specific Conductance3	Float	uS/cm	R	
41167	Specific Conductance3status	Word		R	
41168 - 73	Specific Conductance3time	Word		R	
41180 41181	Dissolved Solid	Float	mg/l	R	
41182	Dissolved Solidstatus	Word		R	
41183 - 88	Dissolved Solidtime	Word		R	
41195 41196	Dissolved Solid1	Float	mg/l	R	
41197	Dissolved Solid1status	Word		R	
41198 - 203	Dissolved Solid1time	Word		R	
41210 41211	Dissolved Solid2	Float	mg/l	R	
41212	Dissolved Solid2status	Word		R	
41213 - 18	Dissolved Solid2time	Word		R	

Table C-1 Modbus Output Registers for Signature Flow Meter

Register Number	Name	Data Type	Units of Measure	Read/Write	Description
41225 41226	Dissolved Solid3	Float	mg/l	R	
41227	Dissolved Solid3status	Word		R	
41228 - 33	Dissolved Solid3time	Word		R	
41240 41241	Salinity	Float	mg/l	R	
41242	Salinitystatus	Word		R	
41243 - 48	Salinitytime	Word		R	
41255 41256	Salinity1	Float	mg/l	R	
41257	Salinity1status	Word		R	
41258 - 63	Salinity1time	Word		R	
41270 41271	Salinity2	Float	mg/l	R	
41272	Salinity2status	Word		R	
41273 - 78	Salinity2time	Word		R	
41285 41286	Salinity3	Float	mg/l	R	
41287	Salinity3status	Word		R	
41288 - 93	Salinity3time	Word		R	
41300 41301	Dissolved Oxygen	Float	mg/l	R	
41302	Dissolved Oxygenstatus	Word		R	
41303 - 08	Dissolved Oxygen-time	Word		R	
41315 41316	Dissolved Oxygen1	Float	mg/l	R	
41317	Dissolved Oxygen1status	Word		R	
41318 - 23	Dissolved Oxygen1time	Word		R	
41330 401331	Dissolved Oxygen2	Float	mg/l	R	
41332	Dissolved Oxygen2status	Word		R	
41333 - 38	Dissolved Oxygen2time	Word		R	
41345 41346	Dissolved Oxygen3	Float	mg/l	R	

Table C-1 Modbus Output Registers for Signature Flow Meter

Register Number	Name	Data Type	Units of Measure	Read/Write	Description
41347	Dissolved Oxygen3status	Word		R	
41348 - 53	Dissolved Oxygen3time	Word		R	
41360 41361	pH	Float	pH	R	
41362	pHstatus	Word		R	
41363 - 68	pHtime	Word		R	
41375 41376	pH1	Float	pH	R	
41377	pH1status	Word		R	
41378 - 83	pH1time	Word		R	
41390 41391	pH2	Float	pH	R	
41392	pH2status	Word		R	
41393 - 98	pH2time	Word		R	
41405 41406	pH3	Float	pH	R	
41407	pH3status	Word		R	
41408 - 13	pH3time	Word		R	
41420 41421	ORP	Float	Volts	R	
41422	ORPstatus	Word		R	
41423 - 28	ORPtime	Word		R	
41435 41436	ORP1	Float	Volts	R	
41437	ORP1status	Word		R	
41438 - 43	ORP1time	Word		R	
41450 41451	ORP2	Float	Volts	R	
41452	ORP2status	Word		R	
41453 - 58	ORP2time	Word		R	
41465 41466	ORP3	Float	Volts	R	
41467	ORP3status	Word		R	
41468 - 73	ORP3time	Word		R	
41480 41481	NH4 Nitrogen	Float	mg/l	R	
41482	NH4 Nitrogenstatus	Word		R	

Table C-1 Modbus Output Registers for Signature Flow Meter

Register Number	Name	Data Type	Units of Measure	Read/Write	Description
41483 - 88	NH4 Nitrogentime	Word		R	
41495 41496	NH4 Nitrogen1	Float	mg/l	R	
41497	NH4 Nitrogen1status	Word		R	
41498 - 503	NH4 Nitrogen1time	Word		R	
41510 41511	NH4 Nitrogen2	Float	mg/l	R	
41512	NH4 Nitrogen2status	Word		R	
41513 - 18	NH4 Nitrogen2time	Word		R	
41525 41526	NH4 Nitrogen3	Float	mg/l	R	
41527	NH4 Nitrogen3status	Word		R	
41528 - 33	NH4 Nitrogen3time	Word		R	
41540 41541	NO3 Nitrogen	Float	mg/l	R	
41542	NO3 Nitrogenstatus	Word		R	
41543 - 48	NO3 Nitrogentime	Word		R	
41555 41556	NO3 Nitrogen1	Float	mg/l	R	
41557	NO3 Nitrogen1status	Word		R	
41558 - 63	NO3 Nitrogen1time	Word		R	
41570 41571	NO3 Nitrogen2	Float	mg/l	R	
41572	NO3 Nitrogen2status	Word		R	
41573 - 78	NO3 Nitrogen2time	Word		R	
41585 41586	NO3 Nitrogen3	Float	mg/l	R	
41587	NO3 Nitrogen3status	Word		R	
41588 - 93	NO3 Nitrogen3time	Word		R	
41600 41601	Turbidity	Float	NTU	R	
41602	Turbiditystatus	Word		R	
41603 41608	Turbiditytime	Word		R	
41615 41616	Turbidity1	Float	NTU	R	
41617	Turbidity1status	Word		R	
41618 - 23	Turbidity1time	Word		R	

Table C-1 Modbus Output Registers for Signature Flow Meter

Register Number	Name	Data Type	Units of Measure	Read/Write	Description
41630 41631	Turbidity2	Float	NTU	R	
41632	Turbidity2status	Word		R	
41633 - 38	Turbidity2time	Word		R	
41645 41646	Turbidity3	Float	NTU	R	
41647	Turbidity3status	Word		R	
41648 41653	Turbidity3time	Word		R	
41660 41661	Chloride	Float	mg/l	R	
41662	Chloridestatus	Word		R	
41663 - 68	Chloridetime	Word		R	
41675 41676	Chloride1	Float	mg/l	R	
41677	Chloride1status	Word		R	
41678 - 83	Chloride1time	Word		R	
41690 41691	Chloride2	Float	mg/l	R	
41692	Chloride2status	Word		R	
41693 - 98	Chloride2time	Word		R	
41705 41706	Chloride3	Float	mg/l	R	
41707	Chloride3status	Word		R	
41708 - 13	Chloride3time	Word		R	
41720 41721	Resistivity	Float	Ohm-cm	R	
41722	Resistivitystatus	Word		R	
41723 41728	Resistivitytime	Word		R	
41735 41736	Resistivity1	Float	Ohm-cm	R	
41737	Resistivity1status	Word		R	
41738 - 43	Resistivity1time	Word		R	
41750 41751	Resistivity2	Float	Ohm-cm	R	
41752	Resistivity2status	Word		R	
41753 - 58	Resistivity2time	Word		R	
41765 41766	Resistivity3	Float	Ohm-cm	R	

Table C-1 Modbus Output Registers for Signature Flow Meter

Register Number	Name	Data Type	Units of Measure	Read/Write	Description
41767	Resistivity3status	Word		R	
41768 - 73	Resistivity3time	Word		R	
41780 41781	Pressure	Float	mmHg	R	
41782	Pressurestatus	Word		R	
41783 - 88	Pressuretime	Word		R	
41795 41796	Pressure1	Float	mmHg	R	
41797	Pressure1status	Word		R	
41798 - 803	Pressure1time	Word		R	
41810 41811	Pressure2	Float	mmHg	R	
41812	Pressure2status	Word		R	
41813 - 18	Pressure2time	Word		R	
41825 41826	Pressure3	Float	mmHg	R	
41827	Pressure3status	Word		R	
41828 - 33	Pressure3time	Word		R	
41840 41841	Reserved	Float		R	
41842	Reservedstatus	Word		R	
41843 - 48	Reservedtime	Word		R	
41855 41856	Generic	Float		R	
41857	Genericstatus	Word		R	
401858 - 63	Generictime	Word		R	
401870 401871	Generic1	Float		R	
41872	Generic1status	Word		R	
41873 - 78	Generic1time	Word		R	
41885 41886	Generic2	Float		R	
41887	Generic2status	Word		R	
41888 - 93	Generic2time	Word		R	
41900 41901	Generic3	Float		R	
41902	Generic3status	Word		R	
41903 - 08	Generic3time	Word		R	

Table C-1 Modbus Output Registers for Signature Flow Meter

Register Number	Name	Data Type	Units of Measure	Read/Write	Description
41915 41916	Generic4	Float		R	
41917	Generic4status	Word		R	
41918 - 23	Generic4time	Word		R	
41930 41931	Generic5	Float		R	
41932	Generic5status	Word		R	
41933 - 38	Generic5time	Word		R	
41945 41946	Generic6	Float		R	
41947	Generic6status	Word		R	
41948 - 53	Generic6time	Word		R	
41960 41961	Generic7	Float		R	
41962	Generic7status	Word		R	
41963 - 68	Generic7time	Word		R	
41975 41976	Generic8	Float		R	
41977	Generic8status	Word		R	
41978 - 83	Generic8time	Word		R	
41990 41991	Wireless Power	Float		R	
41992	Wireless Powerstatus	Word		R	
41993 - 98	Wireless Powertime	Word		R	

Signature® Flow Meter

Appendix D Material Safety Data Sheets

This appendix provides Material Safety Data Sheets for the desiccant used by the Signature Flow Meter.

Teledyne Isco cannot guarantee the accuracy of the data. Specific questions regarding the use and handling of the products should be directed to the manufacturer listed on the MSDS.

SORB-IT® is a registered trademark of N. T. Gates Company.

MATERIAL SAFETY DATA SHEET



sSORB®



Health	1
Fire	0
Reactivity	0
Personal Protection	2

Section 1: CHEMICAL PRODUCT & COMPANY IDENTIFICATION			
Product Name: sSORB®	Supplier: Interra Global Corporation	371 Edgemont Lane	
Chemical Name: Yellow Indicating Silica Gel		Park Ridge, IL 60068	
Synonyms: Orange Indicating Silica Gel		USA	
Emergency Assistance			
USA	+ 1.847.292.8600	Telephone:	+ 1.847.292.8600
Outside USA	+ 1.847.292.8600	Fax:	+ 1.847.292.8601

Section 2: COMPOSITION & INFORMATION ON INGREDIENTS
CAS Numbers: 1343-98-2, 77-09-8
Molecular Formula: SiO ₂ · nH ₂ O + C ₂₀ H ₁₄ O ₄

Section 3: HAZARDS IDENTIFICATION
Potential Health Effects
Inhalation: May cause dryness and irritation to mucous membranes, nose and throat. Symptoms may include coughing, sore throat, and wheezing.
Ingestion: No adverse effects expected.
Skin Contact: May cause irritation with dryness and abrasion.
Eye Contact: May cause irritation, redness and pain.
Chronic Exposure: Repeated exposure may cause symptoms similar to those listed for acute effects. Synthetic amorphous silica does not produce silicosis.

Section 4: FIRST AID MEASURES
Eye Contact: Check for and remove any contact lenses. In case of contact, immediately flush eyes with plenty of water for at least 15 minutes. Get medical attention if irritation occurs.
Skin Contact: Wash with soap and water. Cover the irritated skin with an emollient. Get medical attention if irritation develops.
Ingestion: Give several glasses of water to drink to dilute. If large amounts were swallowed, get medical advice.
Inhalation: If inhaled, remove to fresh air. If breathing is difficult, get medical attention.

Section 5: FIRE & EXPLOSION DATA
Fire: Not considered to be a fire hazard.
Explosion: Not considered to be an explosion hazard.
Fire Fighting Media and Instructions: Use any means suitable for extinguishing surrounding fire.
Special Remarks: Use protective clothing and breathing equipment appropriate for surrounding fire.

INTERRA Global Corporation

msds sSORB



p1

MATERIAL SAFETY DATA SHEET

Section 6: ACCIDENTAL RELEASE MEASURES

Small Spill: Use appropriate tools to put the spilled solid in a convenient waste disposal container. Use respiratory protection and eye protection.

Large Spill: Use a shovel to put the material into a convenient waste disposal container. Vacuuming or wet sweeping may be used to avoid dust dispersal. Use respiratory protection and eye protection.

Section 7: HANDLING & STORAGE

Storage: Keep container tightly closed. Suitable for any general chemical storage area. Containers of this material may be hazardous when empty since they retain product residues (dust, solids); observe all warnings and precautions listed for the product.

Section 8: EXPOSURE CONTROLS / PERSONAL PROTECTION

Engineering Controls: Use process enclosures, local exhaust ventilation, or other engineering controls to keep airborne levels below recommended exposure limits. If user operations generate dust, fume or mist, use ventilation to keep exposure to airborne contaminants below the exposure limit.

Personal Protection: Safety glasses. Lab coat. Respirator (NIOSH Approved). Gloves.

Section 9: PHYSICAL & CHEMICAL PROPERTIES

Physical state:	Solid	Boiling Point:	2230C (4046F)
Color:	Yellow/Orange-Dry:Green-Saturated	Melting Point:	1610C (2930F)
Odor:	Odorless	Vapor Pressure:	Not applicable.
Solubility:	Insoluble	Vapor Density:	Not applicable.
Specific Gravity:	2.1 (Water=1)	Evaporation Rate:	Not available.
pH :	3 - 8 (in 5% slurry)	% Volatiles by volume @ 21C (70F):	0

Section 10: STABILITY & REACTIVITY

Stability: The product is stable.

Hazardous Decomposition Products: Oxides of carbon and silicon may be formed when heated.

Hazardous Polymerization: Will not occur.

Incompatibility with powerful oxidizers: Reacts with hydrogen fluoride, fluorine, oxygen difluoride, chlorine trifluoride, strong acids, strong bases, and oxidizers.

Conditions to Avoid: Moisture, extreme heat, and incompatibles.

Section 11: TOXICOLOGICAL INFORMATION

Routes of Entry: Absorbed through skin. Eye contact. Inhalation. Ingestion.

Toxicity to Animals:

LD50: Not available.

LC50: Not available.

Section 12: ECOLOGICAL INFORMATION

Ecotoxicity: This material is not expected to be toxic to aquatic life.

MATERIAL SAFETY DATA SHEET

Section 13: DISPOSAL CONSIDERATIONS

Waste Disposal: Waste must be disposed of in accordance with federal, state and local environmental control regulations.

Section 14: TRANSPORT INFORMATION

DOT Classification: Not a DOT controlled material (United States).
Identification: Not applicable.

Section 15: OTHER REGULATORY INFORMATION

HMIS (U.S.A.):

Health Hazard: 1
Fire Hazard: 0
Reactivity: 0
Personal Protection: E

National Fire Protection Association (U.S.A.):

Health: 1
Flammability: 0
Reactivity: 0

Section 16: OTHER INFORMATION

References: Not available.
Other Special Considerations: Not available.

Created: 04/03/2009 11:20 AM
Last Updated: 03/25/2010 10:40 AM

The purpose of this Safety Data Sheet is to describe the products in terms of their safety requirements. The information above is believed to be accurate and represents the best information currently available to us. However, we make no warranty of merchantability or any other warranty, express or implied, with respect to such information, and we assume no liability resulting from its use. Users should make their own investigations to determine the suitability of the information for their particular purposes. In no event shall Interra Global Corporation be liable for any claims, losses, or damages of any third party or for lost profits or any special, indirect, incidental, consequential or exemplary damages, howsoever arising, even if Interra Global Corporation has been advised of the possibility of such damages.

MATERIAL SAFETY DATA SHEET

SÜD-CHEMIE
Creating Performance Technology



Date Issued: 07/06/2004
MSDS No: 5008
Date-Revised: 11/28/2011
Revision No: 3

Desi Pak®

1. PRODUCT AND COMPANY IDENTIFICATION

PRODUCT NAME: Desi Pak®
GENERAL USE: Desiccant

MANUFACTURER

Süd-Chemie Performance Packaging
101 Christine Drive
Rio Grande Industrial Park
Belen, NM 87002
Customer Service: 505-864-6691

24 HR. EMERGENCY TELEPHONE NUMBERS

CHEMTREC : (800) 424 - 9300
Outside the U.S. Call Collect : 001 (703) 527-3887

2. HAZARDS IDENTIFICATION**EMERGENCY OVERVIEW**

PHYSICAL APPEARANCE: Performance packaging product, size and type vary.

IMMEDIATE CONCERNS: Poses little or no immediate hazard.

POTENTIAL HEALTH EFFECTS

EYES: Route of exposure unlikely. Dust may cause a mechanical irritation which can scratch the eye.

SKIN: No adverse effects expected.

INGESTION: Non-toxic by ingestion. Packets or canisters may pose a choking hazard. Keep away from children and pets.

INHALATION: Route of exposure unlikely. This material is normally packaged and contained in a pouch, bag or canister. If the container is opened, prolonged or repeated inhalation of high dust concentrations may cause lung damage.

3. COMPOSITION / INFORMATION ON INGREDIENTS

INGREDIENT(S)	CAS	Wt.%
Pouch, Bag, Canister, Stopper, or Cap		1 - 75
Clay	1302-78-9	25 - 99
Silica, quartz	14808-60-7	<0.5

See Section 8 for Exposure Limits

4. FIRST AID MEASURES

EYES: Do not rub eyes. Flush with lukewarm, gently flowing water for 5 minutes or until the particle/dust is removed, while holding the eyelid(s) open. Obtain medical attention.

SKIN: Wash with soap and water.

Desi Pak®

INGESTION: Normally not needed. If large quantities are ingested, call your local Poison Control Center (1-800-222-1222 in the U.S.).

INHALATION: Normally not needed. If exposed to excessive levels of dust or fumes, remove to fresh air and seek medical attention of cough or other symptoms develop or persist.

5. FIRE FIGHTING MEASURES

FLASHPOINT AND METHOD: Material is not flammable

EXTINGUISHING MEDIA: Use extinguishing agent applicable to surrounding fire.

FIRE FIGHTING PROCEDURES: As in any fire, wear self-contained breathing apparatus operated in pressure-demand mode, (NIOSH approved or equivalent) and full protective gear.

6. ACCIDENTAL RELEASE MEASURES

SMALL SPILL: No special precautions required.

LARGE SPILL: With shovel or scoop, place material into appropriate container.

7. HANDLING AND STORAGE

HANDLING: Use of proper hygiene practices in the workplace is recommended.

STORAGE: Store in a dry area.

8. EXPOSURE CONTROLS / PERSONAL PROTECTION**EXPOSURE GUIDELINES**

		HAZARDOUS COMPONENTS			
		EXPOSURE LIMITS			
Chemical Name		OSHA PEL		ACGIH TLV	
		ppm	mg/m ³	ppm	mg/m ³
Clay	TWA	[1]	[1]	[1]	[1]
Silica, quartz	TWA	[2]	[2]	[3]	0.025 [3]

OSHA TABLE COMMENTS:

1. Exposure limits not established.
2. Total Dust = (30 mg/m³)/(%SiO₂+2)
3. Respirable

ENGINEERING CONTROLS: If user operations generate dust, fume or mist, use ventilation to keep exposure to airborne contaminants below the exposure limit.

PERSONAL PROTECTIVE EQUIPMENT

EYES AND FACE: Follow facility guidelines.

SKIN: Use of proper hygiene practices in the workplace is recommended.

RESPIRATORY: Use local exhaust if dusting occurs. Good general ventilation is adequate in the absence of dusts.

COMMENTS: All inert or nuisance dusts, whether mineral, inorganic, or organic, not listed specifically by substance name are covered by the Particulates Not Otherwise Regulated (PNOR) limit which is 5 mg/m³ for respirable fraction and 15 mg/m³ for total dust. ACGIH exposure guidelines of less than 3 mg/m³ (respirable) and 10 mg/m³ (inhalable) have been established for particles (insoluble/poorly soluble) not otherwise specified (PNOS).

Desi Pak®**9. PHYSICAL AND CHEMICAL PROPERTIES**

PHYSICAL STATE: Solid
ODOR: None
pH: Not Determined
PERCENT VOLATILE: None
VAPOR PRESSURE: Not Applicable
VAPOR DENSITY: Not applicable.
EVAPORATION RATE: Not Applicable
VISCOSITY: Not Applicable
OXIDIZING PROPERTIES: None

10. STABILITY AND REACTIVITY

STABLE: Yes
HAZARDOUS POLYMERIZATION: No

11. TOXICOLOGICAL INFORMATION**ACUTE**

Chemical Name	ORAL LD ₅₀ (rat)	DERMAL LD ₅₀ (rabbit)	INHALATION LC ₅₀ (rat)
Clay	> 5000 gm/kg(b.w.)		> 200 mg/L/1H
Silica, quartz	500 gm/kg(b.w.)	No Data Available	No Data Available

CARCINOGENICITY

Chemical Name	NTP Status	IARC Status	OSHA Status
Clay	Not listed.	Not listed.	Not listed.
Silica, quartz	Known Carcinogen	Group I	Not listed.

SENSITIZATION: Not sensitizing

GENERAL COMMENTS: Crystalline silica present is contained within a pouch, canister or bag. No exposure to airborne particles of respirable size is expected under normal conditions of use.

12. ECOLOGICAL INFORMATION

ENVIRONMENTAL DATA: Low hazard for usual industrial or commercial handling.
CHEMICAL FATE INFORMATION: This material is of mineral origin. It is not biodegradable.

13. DISPOSAL CONSIDERATIONS

DISPOSAL METHOD: This product, if discarded as sold, is not a Federal RCRA hazardous waste. Processing, use or

03/21/2012 14:05 FAX 14137368257

005

Desi Pak®

Page 4 of 5

contamination of this product may change the waste management options. State and local disposal regulations may differ from federal disposal regulations.

14. TRANSPORT INFORMATION**DOT (DEPARTMENT OF TRANSPORTATION)****PROPER SHIPPING NAME:** Not regulated**ROAD AND RAIL (ADR/RID)****PROPER SHIPPING NAME:** Not regulated**AIR (ICAO/IATA)****SHIPPING NAME:** Not regulated**VESSEL (IMO/IMDG)****SHIPPING NAME:** Not regulated**CANADA TRANSPORT OF DANGEROUS GOODS****SHIPPING NAME:** Not regulated**15. REGULATORY INFORMATION****UNITED STATES****SARA TITLE III (SUPERFUND AMENDMENTS AND REAUTHORIZATION ACT)****FIRE:** No **PRESSURE GENERATING:** No **REACTIVITY:** No **ACUTE:** No **CHRONIC:** Yes**313 REPORTABLE INGREDIENTS:** Not listed.**CERCLA (COMPREHENSIVE RESPONSE, COMPENSATION, AND LIABILITY ACT)****CERCLA REGULATORY:** Not listed.**TSCA (TOXIC SUBSTANCE CONTROL ACT)****TSCA STATUS:** All components are listed on the TSCA Inventory or are excluded or exempt.**REGULATIONS****STATE REGULATIONS:** California**CALIFORNIA PROPOSITION 65:** This product does not contain chemical(s) known to the state of California to cause cancer, birth defects, or reproductive harm.

Crystalline silica present is contained within a pouch, canister or bag. There is no exposure to airborne particles of respirable size under normal conditions of use.

Chemical Name	Wt.%	Listed
Silica, quartz	<0.5	Cancer

RCRA STATUS: This product, if discarded as sold, is not a Federal RCRA hazardous waste. Processing, use or contamination of this product may change the waste management options. State and local disposal regulations may differ from federal disposal regulations.**CANADA****WHMIS HAZARD SYMBOL AND CLASSIFICATION**

Does not meet classification criteria pursuant to the Canadian Hazardous Products Act.

WHMIS (WORKPLACE HAZARDOUS MATERIALS INFORMATION SYSTEM): This MSDS has been prepared according to the hazard criteria of the Controlled Products Regulations (CPR) and the MSDS contains all of the information required by the CPR.**CANADA INGREDIENT DISCLOSURE LIST:** Contains component(s) listed on the Canadian Hazardous Products Act Ingredient Disclosure List.**CANADIAN ENVIRONMENTAL PROTECTION ACT:** All ingredients are listed on the Canadian Domestic Substances List inventory.

Desi Pak®

**EUROPEAN COMMUNITY
EEC LABEL SYMBOL AND CLASSIFICATION**

Not classified as dangerous

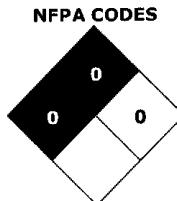
16. OTHER INFORMATION

APPROVED BY: Prepared and approved by SHE Dept. Sud-Chemie Inc.

INFORMATION CONTACT: E-mail - MSDS_US@sud-chemie.com

REVISION SUMMARY: This MSDS replaces the 01/21/2009 MSDS. Revised: **Section 1: INFORMATION CONTACT. Section 16: HMIS RATING (HEALTH, PHYSICAL HAZARD, HMIS RATINGS NOTES, CHRONIC).**

HMIS RATING	
HEALTH	* 1 0
PHYSICAL HAZARD	0
PERSONAL PROTECTION	



HMIS RATINGS NOTES: Personal Protection should be determined based on workplace conditions.

MANUFACTURER DISCLAIMER: The information presented herein is believed to be accurate but is not warranted. Recipients are advised to confirm in advance that the information is current, applicable and suitable to their circumstances.

Signature™ Flow Meter

Index

Numerics

- 301 pH/temperature device, 5-15
- 306 sampler interface, 5-14
- 310 ultrasonic sensor, 5-12
- 330 bubbler module, 5-13
- 350 area velocity sensor, 5-13
- 360 laser velocity sensor, 5-13

A

- AC wiring, 5-2
- accessories, B-1
- adjust display, 1-7
- adjust levels, 2-25, 3-14
- administration, 2-30
 - display license information, 2-32
 - display signature information, 2-32
 - language options, 2-31
 - restore to factory defaults, 2-32
 - sensor diagnostics, 2-31
 - set new passcode, 2-31
 - update firmware, 2-31
- alarm
 - local, 2-27
 - SMS & server, 2-28
- alarms, 2-27
- alphanumerics, 2-8
- analog output, 2-27
 - programming, 5-18, 5-23, 5-27
- area velocity sensor, 5-13

B

- battery backup, 5-4
- browser window, 2-6
- bubbler, 5-13

C

- case board, 3-1
 - layout, 3-3
- CDMA, 5-34
- cellular modems, 5-34
 - CDMA, 5-34
 - GSM, 5-35
 - installation, 5-36
 - setup, 5-39
- character grid, 2-8
- clock, 2-21
- compliance, 2-35
- components, 1-5

- conditions, 2-25
- configure measurements, 2-12
- configure options, 2-20
 - adjust, 2-25
 - data storage/push, 2-27
 - equation/trigger setup, 2-25
 - flow settings, 2-23
 - measurement setup, 2-21
 - outputs, 2-27
 - reports/history, 2-30
 - reset totalizers, 2-30
 - sampler, 2-27
 - site, 2-21
- connecting TIENet devices, 3-7
- connecting via Flowlink, 2-2
- connecting via USB, 2-2
- connections, 3-1, 3-3, 3-4
 - power, 3-11
- contact Teledyne Isco, 6-21
- control panel
 - display, 1-7
 - keypad, 1-7, 2-1
 - LED indicator, 1-7
- cord-grip, 3-5

D

- data
 - compliance, 1-3, 2-35
 - download, 2-35
 - dump, 2-34
 - events, 1-3
 - export, 2-35
 - integrity, 1-3, 2-33, 2-35, 2-36
 - push, 2-27
 - storage, 2-27
- default settings, 2-32
- default units, 2-21
- description, 1-1
- desiccant, 6-5
 - external, 5-11, 6-6
 - internal, 6-5
- device info, 2-5
- diagnostics, 2-31
- display, 1-7
- display contrast, 1-7
- display equipment info, 2-32
- display license info, 2-32
- drop down menus, 2-9
- dump data, 2-34

E

- equations, 2-25
- equipment options, 4-1, 5-1
- ethernet modem, 5-29
 - configuration, 5-32
 - MAC address, 5-33
- event viewer, 2-35
 - export data, 2-35
- events, 1-3
- expansion box, 5-15

F

- factory defaults, 2-32
- firmware, 2-31, 2-34
- firmware updates, 6-2
- flash drive, 2-32, 6-2
- flow conversions, 2-23
- flow measurement, 2-23
- Flowlink, 2-35, 5-29
 - browser, 2-6
 - connecting, 2-2
 - devices, 2-5
 - event viewer, 2-35
 - program window, 2-6
 - site info, 2-4

G

- GSM, 5-35

H

- hardware scan, 2-12
- hardware setup, 2-11
 - Modbus input, 2-14
 - Modbus output, 2-18
 - modem, 2-18
 - SDI-12, 2-14
 - smart sensor, 2-12
- histograph, 2-7
- history, 2-30
- home display, 2-21
- home screen, 2-7

I

- installation, 3-1, 4-1
 - mounting, 3-12
 - outdoor, 3-13
- interior, 3-1
- introduction, 1-1

K

- keypad, 1-6, 1-7, 2-1

L

- language, 2-31
- laser velocity sensor, 5-13
- level adjustment, 2-7, 3-14

M

- maintenance, 6-1
 - desiccant, 6-5
 - firmware updates, 6-2
- Material Safety Data Sheets, D-1
- measurement setup
 - flow input, 2-21
 - level input, 2-21
 - volume input, 2-21
- measurements, 2-12
- mechanical totalizer, 5-8
- menus, 2-9, 2-10
- Modbus
 - configurations, C-2
 - glossary, C-3
- Modbus input setup, 2-14
- Modbus output setup, 2-18
- modem
 - cellular, 5-34
 - ethernet, 5-29
- modem setup, 2-18
- mounting options, 3-12
- MSDS, D-1

O

- off-screen content, 2-8
- optional equipment, 1-3, 4-1, 5-1, B-1
 - AC power cord, 5-2
 - battery backup, 5-4
 - cellular modems, 5-34
 - ethernet modem, 5-29
 - expansion box, 5-15
 - external desiccator, 5-11
 - Flowlink, 5-29
 - mechanical totalizer, 5-8
 - TIENet devices, 5-12
- order parts, A-1, B-1
- outputs
 - alarm, 2-27
 - analog, 2-27

P

- passcode, 2-31
- pH/temperature device, 5-15
- port holes, 3-1, 3-4
 - fittings, 3-5
 - plugs, 3-6
- power, 3-11
 - battery backup, 5-4
- power supply replacement, 5-2
- program window, 2-6
- programming, 2-8
 - administration, 2-30
 - alphanumerics, 2-8
 - analog output, 5-18, 5-23, 5-27
 - cellular modem, 5-39
 - character grid, 2-8
 - configure, 2-20

- general rules, 2-8
- hardware setup, 2-11
- menus, 2-10
- navigation, 2-8
- pull down menus, 2-9
- scrolling, 2-8
- top menu, 2-10
- USB options, 2-32

pull down menus, 2-9

pushed data, 2-27

Q

quick start, 1-2

R

repairs, 6-21

replacement parts, A-1

report view, 2-8

reports, 2-30, 2-33

- export, 2-35
- verification, 2-36

reset, 6-20

reset passcode, 2-31

S

safety, 1-v

sampler interface, 2-27, 5-14

scan, 2-12

scrolling, 2-8

SDI-12, 2-14

security, 1-3

select operation, 2-10

sensor diagnostics, 2-31

sensor differences, 2-12

servicing, 6-1, 6-21

setup and programming, 2-1

shield, 3-13

shortcuts, 2-7

- histograph, 2-7
- level adjustment, 2-7
- report view, 2-8

site information, 2-4

site name, 2-21

site setup, 2-21

smart sensor setup, 2-12

software, 2-2, 5-29

specifications, 1-7

system reset, 6-20

T

Technical Service, 6-21

technical specifications, 1-7

TIENet devices, 5-12

- 301 pH/temperature device, 5-15
- 306 sampler interface, 2-27, 5-14
- 310 ultrasonic level sensor, 5-12
- 330 bubbler module, 5-13

- 350 area velocity sensor, 5-13
- 360 laser velocity sensor, 5-13
- connecting, 3-7
- expansion box, 5-15

totalizer reset, 2-30

totalizer, mechanical, 5-8

triggers, 2-25

typing characters, 2-8

U

ultrasonic level sensor, 5-12

units, 2-21, 2-31

update firmware, 2-31, 2-34

USB drivers, 2-2

USB options, 2-32

- dump data, 2-34
- none of the above, 2-34
- retrieve text reports, 2-33
- update firmware, 2-34

user interface, 2-1

- browser, 2-2, 2-6
- Flowlink, 2-2
- keypad, 2-1

V

verification, 2-33, 2-35

verification tool, 2-36

产品中有毒有害物质或元素的名称及含量
Name and amount of Hazardous Substances or Elements in the product

部件名称 Component Name	有毒有害物质或元素 Hazardous Substances or Elements					
	铅 (Pb)	汞 (Hg)	镉 (Cd)	六价铬 (Cr(VI))	多溴联苯 (PBB)	多溴二联苯 (PBDE)
线路板 Circuit Boards	O	O	O	O	O	O
显示 Display	O	O	O	O	O	O
接线 Wiring	O	O	O	O	O	O
内部电缆 Internal Cables	O	O	O	O	O	O
直流电机 DC Motor	O	O	O	O	O	O
接头 Connectors	O	O	O	O	O	O
电池 Battery	X	X	X	O	O	O
电磁阀 Solenoid valve	O	O	O	O	O	O

产品中有毒有害物质或元素的名称及含量：Name and amount of Hazardous Substances or Elements in the product

O: 表示该有毒有害物质在该部件所有均质材料中的含量均在ST/ 标准规定的限量要求以下。

O: Represent the concentration of the hazardous substance in this component's any homogeneous pieces is lower than the ST/ standard limitation.

X: 表示该有毒有害物质至少在该部件的某一均质材料中的含量超出ST/ 标准规定的限量要求。(企业可在此处，根据实际情况对上表中打“X”的技术原因进行进一步说明。)

X: Represent the concentration of the hazardous substance in this component's at least one homogeneous piece is higher than the ST/ standard limitation.

(Manufacturer may give technical reasons to the "X"marks)

环保使用期由经验确定。

The Environmentally Friendly Use Period (EFUP) was determined through experience.

生产日期被编码在系列号码中。前三位数字为生产年(207 代表 2007 年)。随后的一个字母代表月份：A 为一月，B 为二月，等等。

The date of Manufacture is in code within the serial number. The first three numbers are the year of manufacture (207 is year 2007) followed by a letter for the month. "A" is January, "B" is February and so on.

DECLARATION OF CONFORMITY



Application of Council Directive: 2014/30/EU – The EMC Directive
2014/35/EU – The Low Voltage Directive
2012/19/EU – The WEEE Directive
2011/65/EU – The RoHS Directive

Manufacturer's Name: Teledyne Isco
Manufacturer's Address: 4700 Superior, Lincoln, Nebraska 68504 USA
Mailing Address: P.O. Box 82531, Lincoln, NE 68501

Equipment Type/Environment: Laboratory Equipment for Light Industrial/Commercial Environments
Trade Name/Model No: Signature Flow Meter (AC or DC power) with 350, 360, 301 sensors, 306 Sampler Interface, 330 Bubbler, RS485 and Ethernet Modem options

Year of Issue: 2017

Standards to which Conformity is Declared:	EN 61326-1:2013	EMC Requirements for Electrical Equipment for Measurement, Control, and Laboratory Use
	EN 61010-1:2010	Safety Requirements for Electrical Equipment for Measurement, Control, and Laboratory Use
	EN60529	Special Protection offered by the Signature's Enclosure: IP-66
	EN 61000-3-2:2014	Limits for harmonic current emissions (equipment input current \leq 16 A per phase)
	EN 61000-3-3:2013	Limitation of voltage changes, voltage fluctuations and flicker in public low- voltage supply systems, for equipment with rated current \leq 16 A

We, the undersigned, hereby declare that the design of the equipment specified above conforms to the above Directive(s) and Standards as of July 17, 2017.

USA Representative



Edward J. Carter
Director of Engineering
Teledyne Isco
4700 Superior Street
Lincoln, Nebraska 68504
Phone: (402) 464-0231
Fax: (402) 464-3799

60-4302-021
Rev E

Teledyne Isco One Year Limited Factory Service Warranty*

This warranty exclusively covers Teledyne Isco instruments, providing a one-year limited warranty covering parts and labor.

Any instrument that fails during the warranty period due to faulty parts or workmanship will be repaired at the factory at no charge to the customer. Teledyne Isco's exclusive liability is limited to repair or replacement of defective instruments. Teledyne Isco is not liable for consequential damages.

Teledyne Isco will pay surface transportation charges both ways within the 48 contiguous United States if the instrument proves to be defective within 30 days of shipment. Throughout the remainder of the warranty period, the customer will pay to return the instrument to Teledyne Isco and Teledyne Isco will pay surface transportation to return the repaired instrument to the customer. Teledyne Isco will not pay air freight or customer's packing and crating charges. This warranty does not cover loss, damage, or defects resulting from transportation between the customer's facility and the repair facility.

The warranty for any instrument is the one in effect on date of shipment. The warranty period begins on the shipping date, unless Teledyne Isco agrees in writing to a different date.

Excluded from this warranty are normal wear; expendable items such as desiccant, pH sensors, charts, ribbon, lamps, tubing, and glassware; fittings and wetted parts of valves; check valves, pistons, piston seals, wash seals, cylinders, pulse damper diaphragms, inlet lines and filter elements; and damage due to corrosion, misuse, accident, or lack of proper **installation or** maintenance. This warranty does not cover products not sold under the Teledyne Isco trademark or for which any other warranty is specifically stated.

No item may be returned for warranty service without a return authorization number (RMA) issued by Teledyne Isco.

This warranty is expressly in lieu of all other warranties and obligations and Teledyne Isco specifically disclaims any warranty of merchantability or fitness for a particular purpose.

The warrantor is Teledyne Isco, 4700 Superior, Lincoln, NE 68504, U.S.A.

***This warranty applies to the USA and countries where Teledyne Isco does not have an authorized dealer. Customers in countries outside the USA, where Teledyne Isco has an authorized dealer, should contact their Teledyne Isco dealer for warranty service.**

Problems can often be diagnosed and corrected without returning the instrument to the factory. Before returning any instrument for repair, please contact the Teledyne Isco Service Department for instructions and to obtain a return material authorization number (RMA).

Instruments needing factory repair should be packed carefully and shipped to the attention of the service department. Small, non-fragile items can be sent by insured parcel post. **PLEASE WRITE THE RMA NUMBER ON THE OUTSIDE OF THE SHIPPING CONTAINER** and enclose a note explaining the problem.

Shipping Address: Teledyne Isco - Attention Repair Service
4700 Superior Street
Lincoln, NE 68504 USA

Mailing Address: Teledyne Isco
PO Box 82531
Lincoln, NE 68501 USA

Phone: Repair service: (800) 775-2965 (lab instruments)
(866) 298-6174 (samplers & flow meters)
Sales & General Information: (800) 228-4373 (USA & Canada)

Fax: (402) 465-3001

Email: IscoService@teledyne.com



March 2, 2016 P/N 60-1002-040 Rev J



