

Alpha RES 1000

Controller/Transmitter
Resistivity



AQUAfast, Cahn, ionplus, KNIPHE, No Cal, ORION, perpHect, PerpHecT, PerpHecTion, pHISA, pHuture, Pure Water, Sage, Sensing the Future, SensorLink, ROSS, ROSS Ultra, Sure-Flow, Titrator PLUS and TURBO2 are registered trademarks of Thermo Fisher.

1-888-pHAX-ION, A+, All in One, Aplus, AQUAsnap, AssuredAccuracy, AUTO-BAR, AUTO-CAL, AUTO DISPENSER, Auto-ID, AUTO-LOG, AUTO-READ, AUTO-STIR, Auto-Test, BOD AutoEZ, Cable-Free, CERTI-CAL, CISA, DataCOLLECT, DataPLUS, digital LogR, DirectCal, DuraProbe, Environmental Product Authority, Extra Easy/Extra Value, FAST QC, GAP, GLPcal, GLPcheck, GLPdoc, ISEasy, KAP, LabConnect, LogR, Low Maintenance Triode, Minimum Stir Requirement, MSR, NISS, One-Touch, One-Touch Calibration, One-Touch Measurement, Optimum Results, Orion Star, Pentrode, pHuture MMS, pHuture Pentrode, pHuture Quatrode, pHuture Triode, Quatrode, QuiKcheK, rf link, ROSS Resolution, SAOB, SMART AVERAGING, Smart CheK, SMART STABILITY, Stacked, Star Navigator 21, Stat Face, The Enhanced Lab, ThermaSense, Triode, TRIUMpH, Unbreakable pH, Universal Access are trademarks of Thermo Fisher.

Guaranteed Success and The Technical Edge are service marks of Thermo Fisher.

Preface

This instruction manual serves to explain the use of the Alpha RES 1000 series Resistivity controller/transmitter. The manual functions in two ways: firstly as a step by step guide to help the user operate the instrument. Secondly, it serves as a handy reference guide. This instruction manual is written to cover as many anticipated applications of the Alpha RES 1000 Resistivity controller/transmitter. If you have doubts in the use of the instrument, please do not hesitate to contact the nearest Thermo Scientific Authorised Distributor.

The information presented in this manual is subject to change without notice as improvements are made, and does not represent a commitment on part of Thermo Fisher Scientific.

Thermo Fisher Scientific cannot accept any responsibility for damage or malfunction of the unit due to improper use of the instrument.

All rights reserved.

TABLE OF CONTENTS

1	INTRODUCTION	1
1.1	DESCRIPTION OF UNIT	1
1.2	APPLICATIONS	1
2	ASSEMBLY AND INSTALLATION	2
2.1	MEASUREMENT AND CONTROL SYSTEM	2
2.2	UNIT DIMENSIONS	2
3	ELECTRICAL CONNECTION	3
3.1	CONNECTION DIAGRAM	3
3.2	BACK PANEL	4
4	OVERVIEW	5
4.1	KEYPAD AND DISPLAY	5
4.1.1	Keypad	5
4.1.2	Display	5
4.2	FUNCTION GROUPS	6
4.3	CONTROL CONCEPT	7
5	MEASUREMENT	8
5.1	DISPLAY IN MEASUREMENT MODE	8
5.1.1	Check electrode performance	8
5.1.2	Checking set points	8
5.2	SECURITY CODES	8
5.2.1	How to enter and change parameters in Calibration mode	8
5.2.2	How to enter and change parameters in Advanced Setup mode	9
6	CALIBRATION MODE	10
6.1	RESISTIVITY CALIBRATION	10
7	ADVANCED SET-UP MODE	10
7.1	TEMPERATURE COEFFICIENT SUB-FUNCTION	11
7.1.1	Selecting Pure-water or Linear Temperature Coefficient	11
7.2	TEMPERATURE CALIBRATION (ATC MODE ONLY)	12
7.2.1	Setting manual temperature compensation	12
7.3	CONTROL RELAY A/CONTROL RELAY B (SP1/SP2) SUB-FUNCTION	13
7.3.1	Entering the Set point 1 (Set point 2) sub-function	13
7.3.2	Selecting the set point values	13
7.3.3	Choosing High or Low set points	13
7.3.4	Selecting a hysteresis (dead band) value (0.000 to 0.200 m Ω or 0.00 to 2.00 m Ω)	13
7.3.5	Setting an on-delay time lag	14
7.3.6	Setting an off-delay time lag	15
7.4	CONTROLLER (CNTR) SUB-FUNCTION	15
7.4.1	Entering the Controller sub-function	15
7.4.2	Choosing the controller type (limit or proportional)	15
7.4.3	Choosing break/make contact relay type	16
7.4.4	Selecting proportional range value Xp	16
7.4.5	Maximum Pulse Length (tPL) or Maximum Frequency (FPF)	17

7.5	MEASUREMENT RANGE SUB-FUNCTION.....	17
7.5.1	<i>Entering the Measuring Range sub-function.....</i>	17
7.5.2	<i>Selecting Measuring Range sub-function</i>	17
7.5.3	<i>Measurement Range available in the Controller.....</i>	18
7.5.4	<i>Current Output (rng) sub-function</i>	18
7.5.5	<i>Choosing the output type</i>	18
7.5.6	<i>Selecting Resistivity value at 0(4)mA.....</i>	18
7.5.7	<i>Selecting Resistivity value at 20mA</i>	19
7.6	CONFIGURATION (CONF) SUB-FUNCTION	19
7.6.1	<i>Entering Configuration sub-function.....</i>	19
7.6.2	<i>Selecting Filter Function and the Alarm or Wash Function.....</i>	19
7.6.3	<i>Selecting the alarm time lag (if the relay 3 is set to Alarm).....</i>	20
7.6.4	<i>Selecting steady or pulse contact for the alarm relay (if the relay 3 is set to Alarm).....</i>	20
7.6.5	<i>Wash Contact (if the relay 3 is set to Wash).....</i>	20
7.6.6	<i>Input Line Resistance Adjust.....</i>	21
7.6.7	<i>Reverting to factory default settings.....</i>	21
7.7	CALIBRATION (CAL) SUB-FUNCTION	21
7.7.1	<i>Entering Calibration mode from Advanced Set-up mode.....</i>	21
8	AUTO/MANUAL MODE	22
8.1	AUTO MODE (MODE AFTER SWITCH-ON).....	22
8.2	MANUAL MODE	22
9	TECHNICAL SPECIFICATIONS.....	23
10	GENERAL INFORMATION.....	24
10.1	PACKAGING	24
10.2	RETURN OF GOODS.....	24
10.3	GUIDELINES FOR RETURNING UNIT FOR REPAIR	24
11	APPENDICES	25
	APPENDIX 1 – JUMPER POSITIONS	25
	APPENDIX 2 – CONDUCTIVITY / RESISTIVITY OF VARIOUS AQUEOUS SOLUTIONS AT 25°C.....	26
	APPENDIX 3 - SIMPLE EXPLANATION ON THE FUNCTION OF HYSTERESIS	26
	APPENDIX 4 – PURE WATER CURVE.....	27

1 Introduction

1.1 Description of Unit

Thank you for purchasing the Alpha ¼ DIN Alpha RES 1000 Resistivity process controllers. This unit is used for measuring the Resistivity of a solution in mega-ohms. You can use this unit to measure Resistivity with limit control. This controller has many user-friendly and safety features which include:

- **Menu-driven program** that simplifies set-up
- **Two ranges** of Resistivity measurements-software selectable (*Section 7.5.3*).
- **Built-in memory backup** to ensure that calibration data and other information are not erased if power supply fails
- **Automatic temperature compensation (ATC)** with Pt100 or Pt 1000
- **Manual temperature compensation** with independent setting for calibration and process temperature
- Temperature coefficient variable between 0.00 to 10.00 % per °C. Separate pure water compensation curve stored in memory. Reference temperature at 25°C.
- 0 to 1999 second **time delay adjustment** on all relays – minimise false alarms
- Separately adjustable **high and low set point hysteresis** (dead bands) prevent chattering of relays around the set points. Selectable **Filter** function stabilises rapid measurement changes.
- **Three control modes**: limit, proportional pulse length or proportional pulse frequency.
- **Large dual display LCD** for easy reading with clear multiple annunciators, alarm status and operational message annunciators
- **Two switching contacts as set-point triggering relays** and an alarm output relay
- Separate **alarm relay** alerts you when set points have exceeded the limits and if the Pt100/Pt1000 wires are broken or disconnected during the ATC function
- **Hold** function freezes output current (**0/4...20mA**) and releases control relays
- **LED indicators** signal control activities to monitor controller status from a distance
- **Protection against electromagnetic interference** - galvanically isolated 0/4..20mA output provides safety for data logging and control purposes

1.2 Applications

Use this controller in panel mounted enclosures for applications in Pure water and R.O. Systems.

2 Assembly and Installation

2.1 Measurement and Control System

A typical measurement system consists of:

- an Alpha RES 1000 process controller
- a suitable Resistivity electrode with the appropriate Cell constant and integrated temperature sensor Pt 1000 or Pt 100,
- an immersion, flow or process assembly
- a final control element such as pump or valve and
- a chart recorder

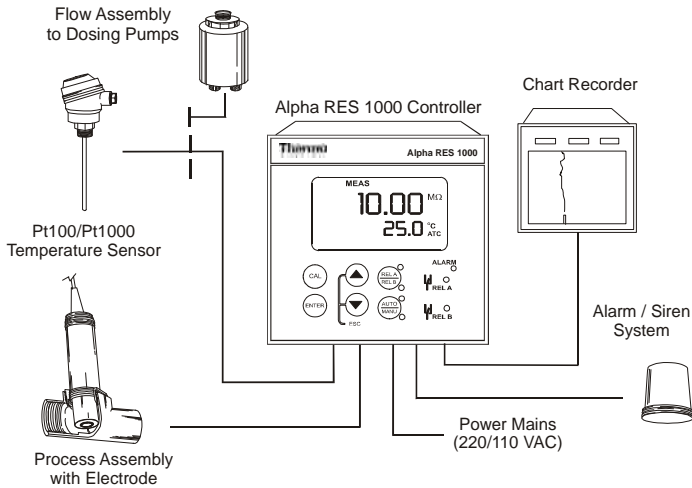

2.2 Unit Dimensions

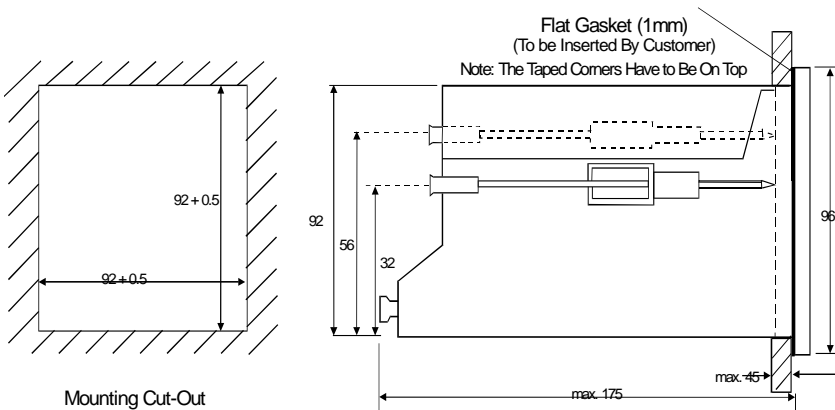

The field-tested control panel housing is 96 x 96 mm; with protection class IP 54 (front).

3 Electrical Connection

3.1 Connection Diagram

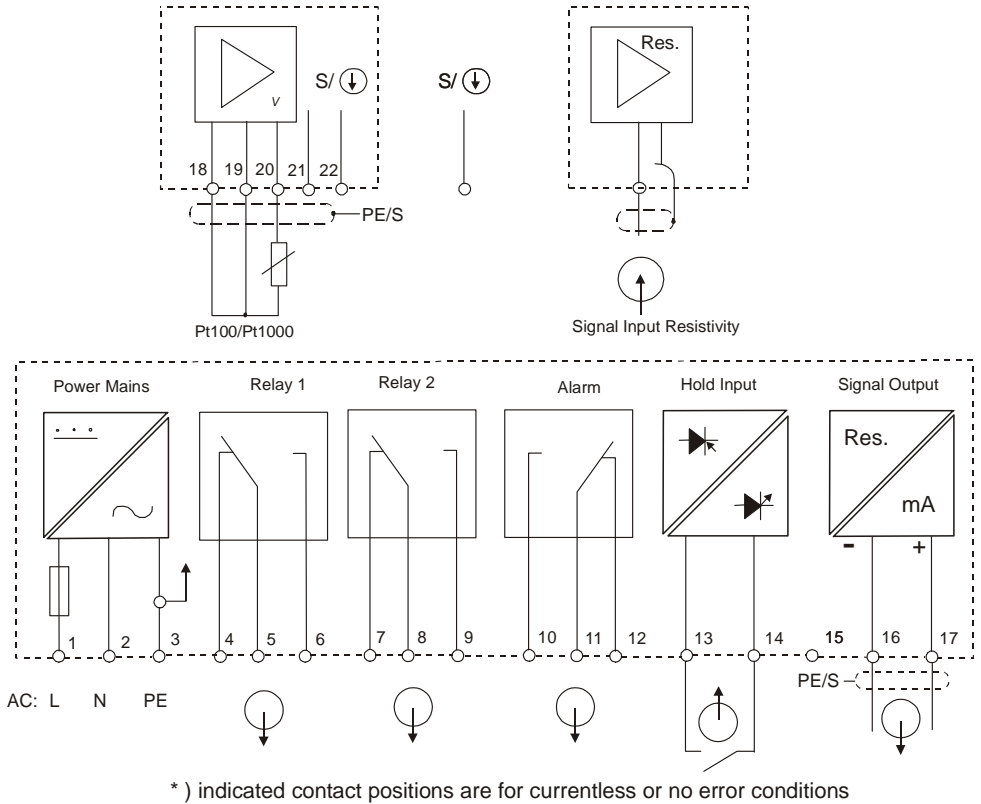

3.2 Back Panel

The back panel consists of two connectors. The first connector is the 17-way PCB edge connector and the other is the 5-way connector.

Connection for the 17-way screw terminals (from left to right):

- | | |
|--|--|
| 1. AC mains live wire | 10. Alarm/Wash relay resting position (NO) |
| 2. AC mains neutral wire | 11. Alarm/Wash relay common |
| 3. AC mains protective earth wire | 12. Alarm/Wash relay working position (NC) |
| 4. Relay 1 relay resting position (NC) | 13. Hold function switch terminal 1 |
| 5. Relay 1 relay common | 14. Hold function switch terminal 2 |
| 6. Relay 1 relay working position (NO) | 15. No connection |
| 7. Relay 2 relay resting position (NC) | 16. 0/4 - 20 mA for -ve connection |
| 8. Relay 2 relay common | 17. 0/4 - 20 mA for +ve connection |
| 9. Relay 2 relay working position (NO) | |

Connections for the 5-way screw terminals:

- 18. Pt1000/Pt100 lead 1 terminal (red)
- 19. Pt1000/Pt100 sense lead terminal (short 18 & 19 if using a two-wire system)
- 20. Pt1000/Pt100 lead 2 terminal (green)
- 21. Resistivity lead 1 (black)
- 22. Resistivity lead 2 (white)

*cable wire colours stated above are applicable to EC-CS10 series. For other electrodes, please check electrode specifications.

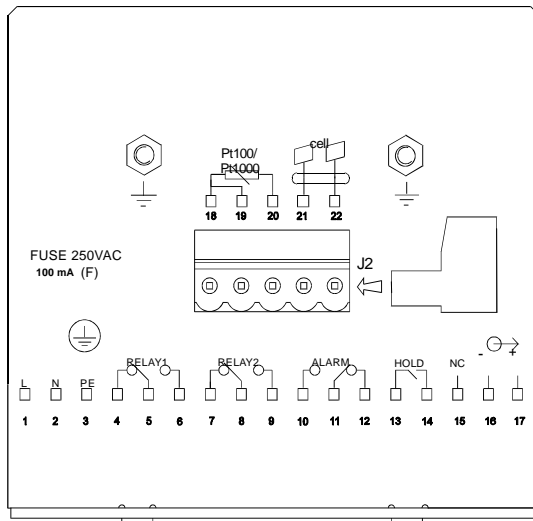

IMPORTANT: The Alarm relay functions as an "Active Low" device i.e. it switches OFF under Alarm condition. Therefore the Alarm display device should be connected to the 'NC' contacts of the relay. If the relay is configured as "wash", then it works in the 'Active High' mode. Therefore the wash pump has to be connected across its "NO" contacts.

4 Overview

4.1 Keypad and Display

4.1.1 Keypad



- Perform rapid calibration



- Allows entry to Set up mode
- Select individual functions within the function group of Set up mode
- Store input data in the **Set up** mode
- Start calibration in the calibration mode

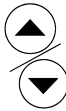

- Select various function groups in the Set up mode.
- Set parameters and numerical values in sub functions of **Set up** mode
If pressed continuously, the setting speed increases



- Control the relays in the **MANUAL** function
- Return to the Measurement mode when both keys are pressed together



- Switch between **AUTO** and **MANUAL** relay operation using a code



- Display set-point values for the switch contacts in **AUTO** operation mode
- Switch between **RELAY A** and **RELAY B** in **MANUAL** relay operation mode

4.1.2 Display

The LCD display features two numerical displays that show status messages and measured values for easy, quick reference. The display provides short-text information for setting parameters and configuration.

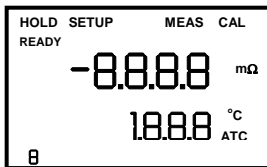

- **HOLD:** Relay position and current output are frozen
- **SETUP:** Set-up mode of function groups
- **MEAS:** Measurement mode
- **CAL:** Calibration mode of Resistivity
- **READY:** Comes on after a successful calibration
- **ATC:** Comes on in the ATC mode. Disappears in the Manual temperature Compensation mode. "ATC" flashes if the temperature probe is faulty in its ATC mode
- **Range No.:** Indicates the measurement range selected



- Display for RELAY A/B. Green LED indicates measured value within limit while RED LED indicates measured value outside limit.



- Alarm display if limit value overshoot or the ATC connection is broken.

4.2 Function Groups

The main function and sub-function groups are organised in a matrix format for configuration and selection of parameters. The main function groups are:

- 1) Temperature Coefficient settings (**tc**)
- 2) Temperature Measurement / compensation settings (**SEt °C**)
- 3) Control relay 1 configuration (**SP1**)
- 4) Control relay 2 configuration (**SP2**)
- 5) Control type (**Cntr**)
- 6) Current output (**rng**)
- 7) Configuration (**ConF**)
- 8) Calibration (**CAL rES**)

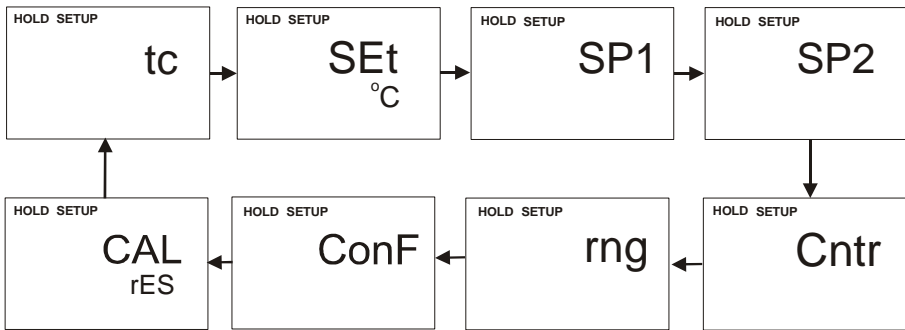

Set-up parameters can be viewed or changed by entering a security code. See Section 5.2 for security code information.

4.2.1 How to view operating parameters without access to change them:

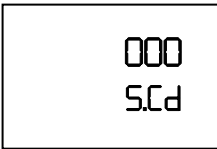

- a) Press **ENTER** key. Display will prompt to enter security code (S.Cd). Leave security code at "000" (do not enter a security code).
- b) Press **ENTER** key again. This allows for viewing (not change) any sub-functions' settings.
- c) Press **Δ** or **∇** keys to scroll through sub-functions.
- d) Press **ENTER** key at a particular sub-function to view in detail.
- e) Press **ENTER** key to return to sub-function menu.
- f) Press **Δ** and **∇** keys simultaneously (Escape key) at any time to return to Measurement mode.

Note: To simplify operations, the controller will not display parameters that are not relevant to a particular sub-function.

4.3 Control Concept

The main function and sub-function groups are organised in a matrix format as shown below. These functions can be accessed via the front keypad for configuration and selection of parameters.

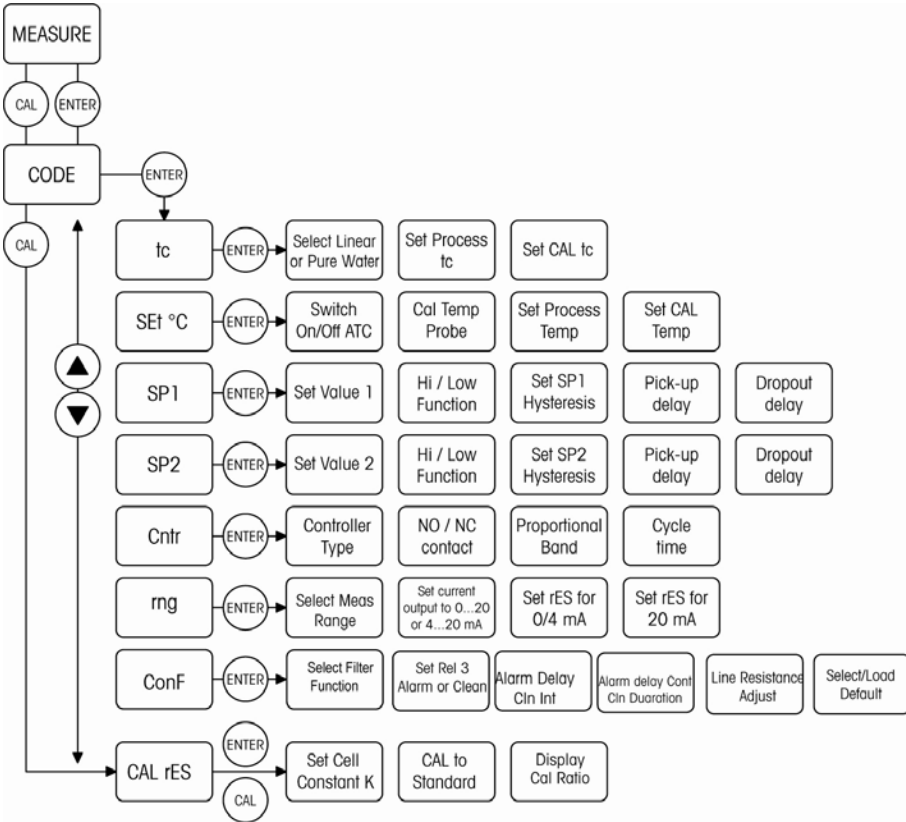

Controller offers three levels of password protection: (1) for viewing all SETUP Configuration without the facility to make changes; (2) for direct access to calibration function; and (3) for setting or editing specific controller parameters or functions in SETUP mode.

Note: Passwords are not user-defined and are set by factory. Please keep passwords confidential to avoid unauthorised tampering of the system.

5 Measurement

5.1 Display in Measurement mode

When controller is powered on, it automatically enters into the Measurement mode after large dual LCD briefly displays all segments.

The upper display shows the measured Resistivity value, while lower display shows temperature value. Annunciators at right side of the display indicate $m\Omega$ and $^{\circ}C$. Similarly annunciators or icons at the top or left side of the display shows current status of controller, e.g. "HOLD", "SETUP", "MEAS", "CAL", "READY", etc.

5.1.1 Check electrode performance

To read current electrode condition without changing them:

- 1) Press the **CAL** key followed by the **ENTER** key without adjusting the security code (leave code at "000"). The upper display shows the last cell constant as a percentage with the lower display shows "CEL". Press **ENTER** key and the next upper display shows the last calibration factor.

Note: If security code is changed to a value other than "000", pressing **ENTER** key will return to Measurement mode, without displaying electrode information.

- 2) Press **ENTER** key a second time to return to Measurement mode.

5.1.2 Checking set points

To read current set point values without changing them:

Press **RELAY Selection (Rel A / Rel B)** key. Upper display shows set point for Relay A; lower display shows "SP1".

After two seconds upper display shows set-point value for Relay B; lower display shows "SP2".

After an additional two seconds, controller returns to Measurement mode.

5.2 Security Codes

Two levels of security protection with separate security codes are provided. First level allows entry into the Calibration mode: security code = 11; second allows entry into SETUP mode: security code = 22.

Security codes protect controller from unauthorised tampering. Parameters cannot be changed unless the security code is entered.

5.2.1 How to enter and change parameters in Calibration mode

- 1) Press **CAL** key. Upper display shows "000" and lower display shows "C.Cd" to prompt for Calibration security code.
- 2) Press **Δ** or **∇** keys to scroll upper display to Calibration security code "11".
- 3) Press **ENTER** key. Display shows "CAL RES".
- 4) Press **ENTER** again to begin calibration. Refer to Section 6 for full details on calibration.
- 5) Press **Δ** and **∇** keys simultaneously (escape) to return to Measurement mode.

NOTE: To view (not change) electrode condition, push **ENTER** key when the security code reads "000".

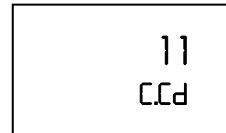

5.2.1.1 Clearing Calibration security code from display

The calibration security code automatically resets from "11" to "000" after returning to Measurement mode.

5.2.2 How to enter and change parameters in Advanced Setup mode

- 1) Press **ENTER** key once. Upper display shows "000" and lower display shows "S.Cd" to prompt for Advanced Setup security code.
- 2) Press **Δ** or **∇** keys to scroll display to Setup security code "22". **NOTE:** Pressing **ENTER** key at a value other than "22" causes the controller to revert to Measurement mode.
- 3) Press **ENTER** key.
- 4) Upper display reads "tc". You are now in the Advanced Setup mode. See Section 7 for complete instructions. To return to Measurement mode, **press Δ and ∇ keys** simultaneously (escape).
NOTE: If to view (not change) set up parameters, push **ENTER** key when security code reads "000".

5.2.2.1 Clearing Advanced Setup security code from display

Having entered the security code and returned to the Measurement mode, security code "22" still appears on display whenever **ENTER** key is pressed. To conceal the security code, it must be manually reset. To clear Advanced Setup security code from display:

- 1) Press **ENTER** key in Measurement mode.
- 2) Set to any security code (not 11 or 22) and complete by pressing **ENTER**.

NOTE: When you enter the Calibration mode with code "11" or Advanced Setup mode with security code "22", unit automatically enters into HOLD mode until you return back to Measurement mode. The HOLD annunciator is displayed at the upper left of the display. While on HOLD, current (0/4..20mA) output is frozen and set point relays are deactivated.

6 Calibration Mode

Calibration mode can be accessed directly from Measurement mode by pressing CAL key and entering the Calibration security code; or from the Advanced Setup mode.

6.1 Resistivity Calibration

Calibration is always carried out in the specific range selected. The Resistivity Controller allows a one-point calibration.

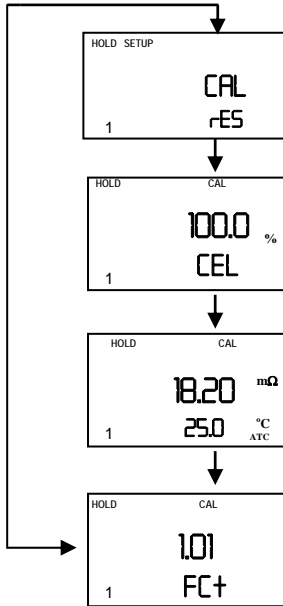

- 1) **Enter Calibration mode.** While in Measurement mode, press CAL key and scroll to Calibration code "11". Press ENTER key. The upper display reads "CAL" and lower display, "rES".
- 2) **Press the ENTER key.** The controller displays its last set Cell Constant (k) of the cell as a percentage of the theoretical value. Using the up and down key, the value can be set to anywhere from 80 to 120%. Press the ENTER key again to carry out calibration.
- 3) Immerse the Conductivity cell in a suitable standard solution, whose value is within the measurement range selected in the controller. Agitate the Cell in the solution to remove any trapped air-bubbles. Note: The calibration standard should have a value that is between 20% to 100% of the range selected. For example, if the range in the controller is selected to be 19.99 mΩ (range 1), then the calibration standard value should be 4.00 mΩ to 19.99 mΩ.
- 4) Once the reading has stabilized, use the Δ or ∇ keys to adjust the measured value to that of the standard solution. Press the ENTER key to accept the value and the controller displays the revised condition of the probe. The lower display shows the factor "FCt" while the upper display shows the ratio of ideal to adjusted calibration value.

Note: The acceptable calibration window is $\pm 40\%$ of the displayed (default) value. If the displayed is 10.00 mΩ standard, the values to which it can be adjusted is 6.00 to 14.00 mΩ. If there is a calibration error, the controller displays "ERR" annunciator. To recalibrate repeat step 3. To exit from calibration, push both Δ and ∇ keys (escape) to resume to Measurement mode.

- 5) **Press ENTER key.** If you entered calibration mode using CAL key, controller will return to Measurement mode. If you entered calibration mode from Advanced Set-up mode, controller will return to sub-function menu.

Note: When calibrating with manual temperature compensation, controller automatically changes from preset process temperature to calibration temperature. After leaving the Calibration mode, controller switches back to process temperature (for setting calibration temperature and process temperature, see section 7.2).

7 Advanced Set-Up Mode

7.1 Temperature Coefficient sub-function

This sub-function allows you to select correct temperature coefficient for optimum operations. For applications in pure water or ultra-pure water industries, select "Pur" temperature coefficient option. For all other applications, select "Lin" temperature coefficient. Controller allows further input of temperature coefficient values, independently for process and for calibrating solutions. Default is "Pur".

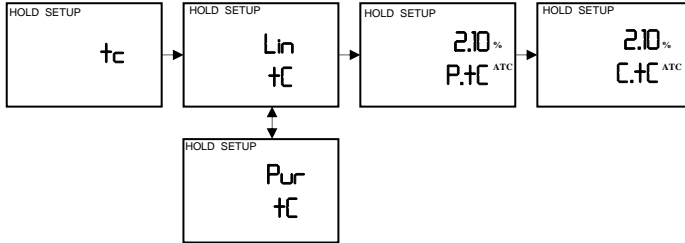

7.1.1 Selecting Pure-water or Linear Temperature Coefficient

- 1) Enter **Advanced set-up mode**. Push ENTER key and scroll to Advanced Set-up security code "22". Push ENTER key. Controller displays "tC". Press ENTER key again. Controller displays "Pur" in upper display and "tC" in lower display. *Default is "Pur"*.
- 2) Press **▲ or ▼ keys** to select between "Pur" and "Lin" temperature coefficients. If "Lin" tC is to be selected, press **ENTER key** when controller displays "Lin".
- 3) If **"Lin" is selected**, upper display shows "2.10%", while lower display show "P.tC". This option allows input of Process Temperature coefficient, from 0 to 10%. *Default is 2.10%*. Use **▲ or ▼ keys** to enter required temperature coefficient value.
- 4) Press **ENTER key**. Next, enter the calibration solution temperature coefficient value, "C.tC", from 0 to 10%. *Default is 2.10%*.
- 5) Press **▲ or ▼ keys** to input desired calibration solution temperature coefficient.
- 6) Press **ENTER key** to accept.
- 7) Continue with additional Advance setup procedures or return to Measurement mode by pressing **▲ and ▼ keys** (escape) simultaneously.

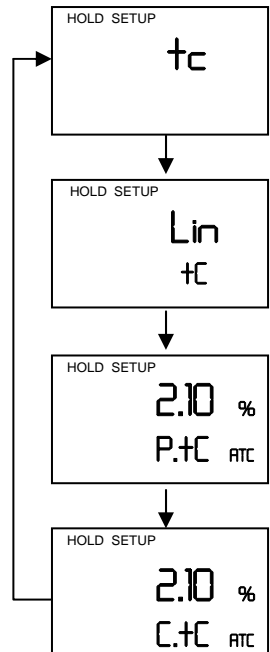

7.2 Temperature calibration (ATC mode only)

- 1) **Enter Advanced Set-up mode.** Push the ENTER key and scroll to Advanced Set-up security code "22". Push the ENTER key again.
- 2) **Press the Δ or ∇ keys** to scroll through the sub-menus until the display shows "Set °C". Press the ENTER key.
- 3) **Press the Δ or ∇ keys** to scroll until the upper display shows "ATC", and the lower display shows "on". Default setting is "ATC on".
- 4) **Press the ENTER key.** In this mode, the ATC probe can be calibrated. The upper display indicates the current temperature offset. The current measured temperature is shown in the lower display.
- 5) Compare the current measured temperature on the controller display to a thermometer known to be accurate. Note down the correct temperature value.
- 6) **Press the Δ or ∇ keys** to scroll the lower display to match the correct value. The upper display will now show the offset value. You can offset temperature up to ± 10 °C.
- 7) **Press the ENTER key** to confirm your selection.
- 8) Continue with additional Advanced Set-up procedures, or return to the Measurement mode by pressing the Δ and ∇ keys (escape) simultaneously.

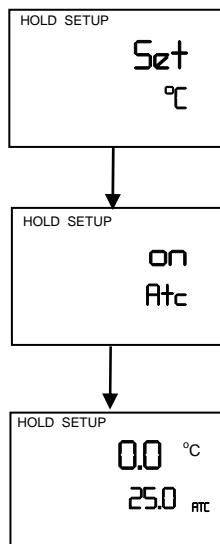

7.2.1 Setting manual temperature compensation

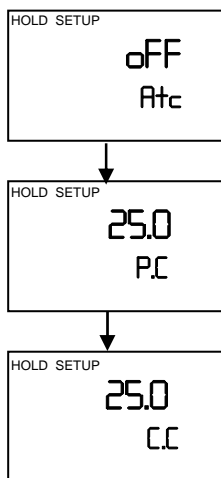

Note: This parameter is unavailable if ATC is selected.

For manual temperature compensation, two different temperatures: process and calibration can be input independently. Example: setting a calibration temperature of 25 °C lets you calibrate using standard buffer solutions at 25 °C, even if process temperature is different.

- 1) **Enter Advanced set-up mode.** Push ENTER key and scroll to Advanced Set-up security code "22". Push ENTER key and **Press Δ or ∇ keys** to scroll till display shows "Set oC". Press ENTER.
- 2) Pressing the **Δ or ∇ keys** toggle between ATC 'on' or 'off' (*default setting is ATC on*). Select "ATC off".
- 3) **Press ENTER key.** Upper display shows current process temperature and lower display shows "P.°C" to indicate process temperature.
- 4) **Press Δ or ∇ keys** to adjust process temperature value from -9.9 to 125 °C.
- 5) **Press ENTER key.** Upper display shows current calibration temperature and lower display shows "C.°C" to indicate calibration temperature.
- 6) **Press Δ or ∇ keys** to adjust calibration temperature value, -9.9 to 125 °C. **Press ENTER key.**
- 7) Continue with additional Advanced Set-up procedures, or return to Measurement mode by pressing Δ and ∇ keys (escape) simultaneously.

7.3 Control Relay A/Control Relay B (SP1/SP2) sub-function

SP1 option sets operating parameters for Relay A; and SP2 for relay B. Since these groups have the same set-up parameters, they are described together.

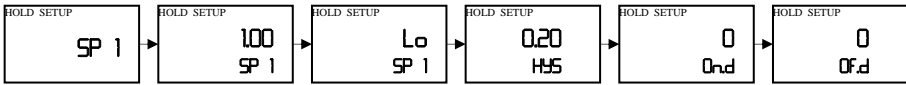

7.3.1 Entering the Set point 1 (Set point 2) sub-function

- 1) **Enter Advanced Set-up mode.** Push the ENTER key and scroll to Advanced Set-up security code "22". Push the ENTER key again.
- 2) **Press the Δ or ∇ keys** to scroll until the upper display shows SP1 (SP2).

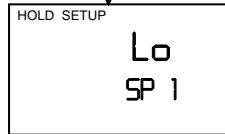
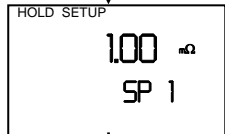
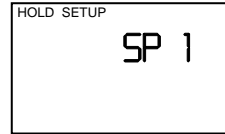

7.3.2 Selecting the set point values

This lets you choose the value that will cause your controller to activate (Default: SP1 = 1.00 m Ω ; SP2 = 19.00 m Ω).

- 1) **Follow directions in 7.3.1** to enter Control Relay mode. If you are in this mode, skip to step 2.
- 2) **Press the ENTER key.** The upper display shows the current set point value and the lower display shows SP1 (SP2).
- 3) **Press the Δ or ∇ keys** to select your value for Set point 1 (Set point 2). Your controller will activate at the value you select.
- 4) **Press the ENTER key** to confirm your selection.
- 5) **Proceed to 7.3.3,** or return to Measurement mode by pressing the Δ and ∇ keys simultaneously (escape).

7.3.3 Choosing High or Low set points

When 'Lo' is selected, the control relay is activated when the value is lower than SP1 (SP2). When 'Hi' is selected, the control relay is activated when the value is higher than the set point (SP1/SP2). Using both SP1 and SP2, you can select lo/lo, lo/hi, hi/lo, or hi/hi set points (Default: SP1 = Lo; SP2 = Hi).

- 1) **Follow directions in 7.3.1** to enter Control Relay mode.
- 2) **Press the ENTER key** until the upper display shows Lo or Hi (for low or high set point) and the lower display shows SP1 (SP2).
- 3) **Press Δ or ∇ keys** to select low (lo) or high (hi) set point for SP1 (SP2). **Press ENTER key.**
- 4) **Proceed to 7.3.4,** or return Measurement mode by pressing Δ and ∇ keys simultaneously (escape).

7.3.4 Selecting a hysteresis (dead band) value (0.000 to 0.200 m Ω or 0.00 to 2.00 m Ω)

Hysteresis prevents rapid contact switching if the value is fluctuating near the set point. It does this by overshooting the set point value to a specified hysteresis value (default is 0.20 m Ω). You can set the hysteresis value from 0.000 to 0.200 m Ω or 0.00 to 2.00 m Ω .

Example: Set point 1 (Lo) is at 1.00 mΩ and hysteresis limit value is at 0.20 mΩ. If measured value undershoots low set point of 1.00 mΩ, relay activates, which in turn activates an external device such as a pump or valve. Actions of the external device will cause the value to rise above 1.00 mΩ. When the value has increased to 1.20 mΩ, relay, and hence the pump will switch off.

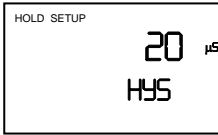

- 1) **Follow directions in 7.3.1** to enter Control Relay mode.
 - 2) **Push the ENTER key.** The upper display shows the hysteresis (dead band) value and the lower display shows "HYS".
 - 3) **Press Δ or ▽ keys** to enter hysteresis value for Set point 1 (Set point 2). Controller will activate at the value selected. **Note:** All settings for SP1 and SP2 are completely independent of each other.
 - 4) **Press ENTER key** to confirm your selection.
 - 5) **Proceed to 7.3.5,** or return to Measurement mode by pressing the Δ and ▽ keys simultaneously (escape).
- NOTE:** Please refer to Appendix 4 for a graphical representation of the Hysteresis.

7.3.5 Setting an on-delay time lag

You can set as time delay for each relay, which stops the relay from switching on the moment the set point is exceeded. This controller lets you set a 0 to 1999 seconds time delay before the relay activates.

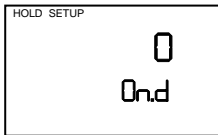

- 1) **Follow directions in 7.3.1** to enter Control Relay mode.
- 2) **Push the ENTER key.** The upper display shows "0" time and the lower display shows "On.d".
- 3) **Press the Δ or ▽ keys** to enter on-delay time for Set point 1 (Set point 2). The controller will delay activation for the number of seconds (0 to 1999) you select.
- 4) **Press the ENTER key** to confirm your selection.
- 5) **Proceed to 7.3.6,** or return to Measurement mode by pressing the Δ and ▽ keys simultaneously (escape).

7.3.6 Setting an off-delay time lag

You can set as time delay for each relay, which stops the relay from switching off the moment the value reached the set point and hysteresis. This controller lets you set a 0 to 1999 seconds time delay before your relay deactivates.

- 1) Follow directions in 7.3.1 to enter Control Relay mode.
- 2) Push the ENTER key. The upper display shows "0" time and the lower display shows "OF.d".
- 3) Press the Δ or ▽ keys to enter on-delay time for Set point 1 (Set point 2). Controller will delay activation for the number of seconds (0 to 1999) selected (*Default off delay is 0*).
- 4) Press the ENTER key to confirm your selection.
- 5) Continue with Advanced Set-up mode procedures, or return to Measurement mode by pressing the Δ and ▽ keys simultaneously (escape).

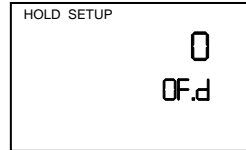

7.4 Controller (Ctr) sub-function

You can set the controller's parameters in this sub-function.

7.4.1 Entering the Controller sub-function

- 1) Enter Advanced Set-up mode. Push ENTER key and scroll to Advanced set-up security code "22". Push ENTER key.
- 2) Press Δ or ▽ keys to scroll until upper display shows "Ctr".

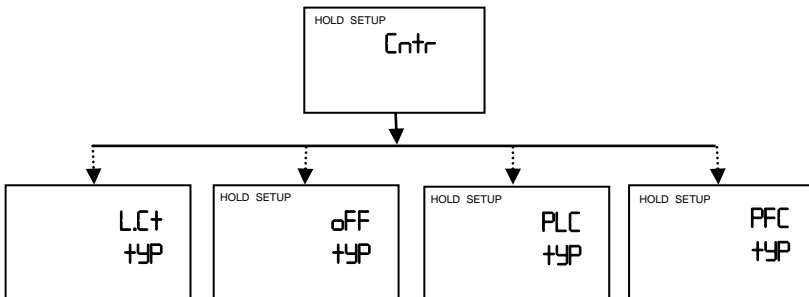

7.4.2 Choosing the controller type (limit or proportional)

This mode lets you choose your controller type: limit control, pulse length proportional control, pulse frequency proportional control, or control off.

- Use limit control with pumps or valves for fast response.
- Use pulse frequency proportional control to operate your pumps smoothly.
- Use pulse length proportional control for precise control of proportioning valves.
- Use control off to operate controller as a monitor only or to keep relays from switching.

- 1) **Follow directions in 7.4.1** to enter Controller mode.
- 2) **Press the ENTER key.** The upper display shows the current controller type and the lower display shows "YP".
- 3) **Press the Δ and ▽ keys** to select your controller type.
 - L.Ct = limit value pickup (on/off control).
 - oFF = controller off.
 - PLC = pulse length control.
 - PFC = pulse frequency control.
- 4) **Press the ENTER key** to confirm your selection.
- 5) **Proceed to 7.4.3 step 3,** or return to Measurement mode by pressing the Δ and ▽ keys simultaneously (escape).

7.4.3 Choosing break/make contact relay type

Note: If the controller type "oFF" is set, the parameters listed in 7.4.4 and 7.4.5 are blanked out.

This mode lets you determine the relay-state under Non-Alarm condition – dEEN (de-energised) or EN (energised).

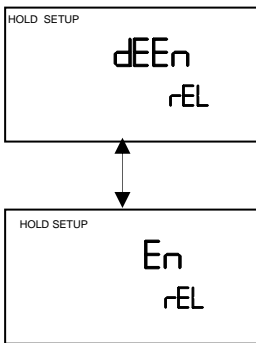

- 1) **Follow directions in 7.4.1** to enter Controller mode.
- 2) **Press the ENTER key.** Scroll until the lower display shows "rEL" and the upper display shows the current selection (de-energised = dEEN or energised = EN).
- 3) **Press the Δ or ▽ keys** to choose de-energised or energised relay state.
- 4) **Press the ENTER key** to confirm your selection.
- 5) Continue with Advanced Set-up mode procedures, or return to Measurement mode by pressing the Δ and ▽ keys simultaneously (escape).

7.4.4 Selecting proportional range value Xp

Note: If the controller type "oFF" or "L.Ct" is set, the parameters listed in 7.4.4 and 7.4.5 are blanked out.

This mode lets you set a band as a percentage of its full scale value. You can select this range from 10 to 200%, and the lower display shows "PrP".

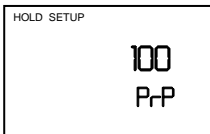

- 1) **Follow directions in 7.4.1** to enter Controller mode.
- 2) **Press the ENTER key.** Scroll until the upper display shows the proportional range (a number from 10 to 200%), and the lower display shows "PrP".
- 3) **Press the Δ and ▽ keys** to choose the proportional range value Xp.
- 4) **Press the ENTER key** to confirm your selection.
- 5) **Proceed to 7.4.5 step 3,** or return to Measurement mode by pressing the Δ and ▽ keys simultaneously (escape).

7.4.5 Maximum Pulse Length (tPL) or Maximum Frequency (FPF)

Note: If the controller type "oFF" or "L.Ct" is set, the parameters listed in 7.4.4 and 7.4.5 are blanked out.

This mode lets you set the maximum pulse length or the maximum frequency at which the relay will operate.

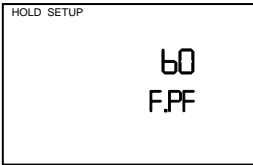
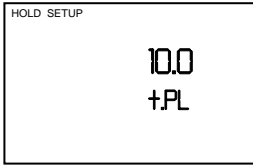

- 1) Follow directions in 7.4.1 to enter Controller mode.
- 2) Press the ENTER key. Scroll until the lower display shows "t.PL" or "F.PF".
 - In PLC (pulse length) mode: The lower display shows "t.PL" to indicate pulse length. The upper display shows your current pulse length. You can select any value from 0.5 to 20 seconds.
 - In PFC (pulse frequency) mode: The lower display shows F.PF to indicate pulse frequency. The upper display shows your current maximum pulse rate. You can select any value from 60 to 120 pulses per minute. When the measured value exceeds the Proportional Band in 7.4.4, the controller will pulse the relay at this rate.
- 3) Press the Δ and ▽ keys to choose the period duration or maximum frequency, depending on your mode.
- 4) Press the ENTER key to confirm your selection and to return to Advanced Set-up mode, or return to Measurement mode by pressing the Δ and ▽ keys simultaneously (escape).

7.5 Measurement Range sub-function

In this sub-function, appropriate range is selected with the appropriate cell constant.

7.5.1 Entering the Measuring Range sub-function

- 1) Enter Advanced Set-up mode. Push ENTER key and scroll to Advanced Set-up security code "22". Push ENTER key.
- 2) Press Δ or ▽ keys to scroll until upper display shows "rng".

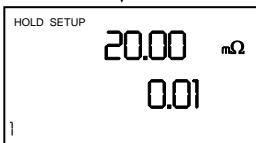
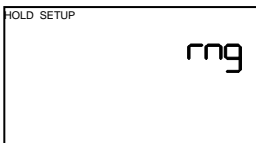

7.5.2 Selecting Measuring Range sub-function

- 1) Follow directions in 7.5.1 to enter Controller mode and press ENTER key.
- 2) Press Δ or ▽ keys to select correct range. (Please refer to 7.5.3 for full list of measurement ranges). Note the upper display shows maximum measurement range, while lower display shows Cell constant. Lower left-corner of LCD displays the number corresponding to the respective range.
- 3) Press ENTER key to confirm.
- 4) Proceed to 7.5.4 to set current output or return to Measurement mode by pressing Δ and ▽ keys simultaneously (escape).

7.5.3 Measurement Range available in the Controller

Range No.	Range	Resolution	Default cell K
1	0.000 – 19.99 m Ω	0.01 m Ω	0.01
2	0.00 – 1.999 m Ω	0.001 m Ω	0.1

7.5.4 Current Output (rng) sub-function

This sub-function lets you set the transmitter current output range of this unit. The difference between the upper and lower range has to be a minimum of 20% of Full Scale, anywhere on the scale.

- 1) Follow directions in 7.5.2 to enter Controller mode.
- 2) Press ENTER key. Please refer to 7.5.5 for current output sub-function.

7.5.5 Choosing the output type

This parameter lets you choose between 0-20 mA or 4-20 mA output.

- 1) Follow directions in 7.5.4 to enter Current Output mode.
- 2) Scroll with the ENTER key until the upper display shows the output type (0-20 or 4-20), and the lower display shows "out".
- 3) Press the Δ or ∇ keys to select your output type: 0-20 or 4-20 mA.
- 4) Press ENTER key to confirm your selection.
- 5) Proceed to 7.5.6, or return to Measurement mode by pressing the Δ and ∇ keys simultaneously (escape).

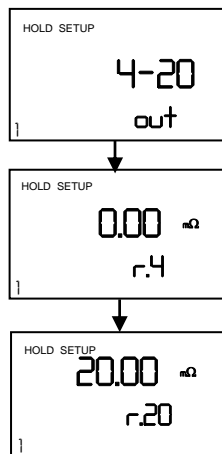

7.5.6 Selecting Resistivity value at 0(4)mA

This parameter selects the resistivity value at which transmitter output will be 0(4) mA. Follow directions in 7.5.4 to enter Current Output mode.

- 1) Press ENTER key until upper display shows a resistivity value and lower display shows "r.0(4)".
- 2) Press Δ or ∇ keys to select required resistivity value to be equivalent to 0(4) (Default is 0.00 m Ω). Please note that difference between value at 4mA and 20mA must be at least 20% of F.S. Press ENTER key.
- 3) Press ENTER key to return to Advanced Set-up mode, or return to Measurement mode by pressing Δ and ∇ keys simultaneously (escape).

7.5.7 Selecting Resistivity value at 20mA

This parameter selects the resistivity value at which transmitter output will be 20mA.

- 4) Follow directions in 7.5.4 to enter Current Output mode.
- 5) Press the ENTER key until upper display shows a resistivity value and lower display shows "r.20".
- 6) Press the Δ or ▽ keys to select the required resistivity value to be equivalent to 20 mA (Default is 20.00 mΩ). Note that difference between the value at 4mA and 20mA must be at least 20% of F.S.
- 7) Press the ENTER key to confirm your selection.
- 8) Press the ENTER key to return to Advanced Set-up mode, or return to Measurement mode by pressing the Δ and ▽ keys simultaneously (escape).

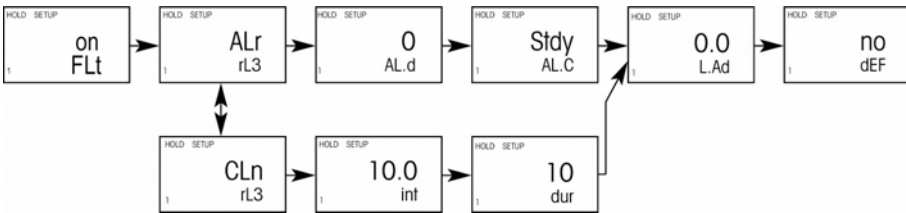

7.6 Configuration (ConF) sub-function

This group of parameters lets you configure the controller to suit your requirements.

7.6.1 Entering Configuration sub-function

- 1) Enter Advanced Set-up mode. Push ENTER key and scroll to Advanced Set-up security code "22". Push ENTER key.
- 2) Press Δ or ▽ keys to scroll until upper display shows "ConF". Press ENTER key to enter configuration sub-function.

7.6.2 Selecting Filter Function and the Alarm or Wash Function

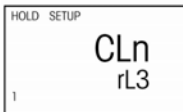

In this configuration sub-function, you have the 'Filter' selection which lets you filter rapid measurement changes and stabilising the measurement. This configuration sub-function also allows you to use the Alarm relay as Wash or Clean contact. The Wash (Clean) contact is used in combination with automatic cleaning systems. During the wash cycle, the analog output is set on hold.

- 1) In Filter selection mode, use the arrow keys to choose filter "on" or "off".
- 2) Press the ENTER key to confirm. Display will now show "ALr" or "CLn".
- 3) Press the Δ or ▽ keys to choose "ALr" (Alarm) or "CLn" (Clean) function.
- 4) Press the ENTER key to confirm your selection.
- 5) Proceed to 7.6.3, or return to Measurement mode by pressing the Δ and ▽ keys simultaneously (escape).

Note: The factory default setting for the Filter selection is "on".

7.6.3 Selecting the alarm time lag (if the relay 3 is set to Alarm)

This parameter group lets you select a period of time before the alarm activates when your set point has been overshoot. You can select from 0 to 1999 seconds.

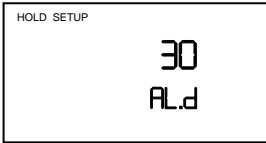

- 1) Follow directions in 7.6.1 to enter Configuration mode.
- 2) Press the ENTER key until the upper display shows a numerical value (in seconds) and the lower display shows "AL.d".
- 3) Press the Δ or ▽ keys to select how long of an alarm delay (0 to 1999 seconds) you want.
- 4) Press the ENTER key to confirm your selection.
- 5) Proceed to 7.6.4, or return to Measurement mode by pressing the Δ and ▽ keys simultaneously (escape).

7.6.4 Selecting steady or pulse contact for the alarm relay (if the relay 3 is set to Alarm)

This parameter group selects whether alarm contact will operate as a steady contact or a fleeting (single pulse) contact. Pulse contact closing time is 1 second.

- 1) Follow directions in 7.6.1 to enter Configuration mode. Press ENTER key until the upper display shows "StdY" or "FLEt" and lower display shows "AL.C.".
 - AL.C = alarm contact
 - StdY = steady contact
 - FLEt = fleeting (single pulse) contact
- 2) Press Δ or ▽ keys to select steady or pulse contact. Press ENTER key.
- 3) Proceed to 7.6.5, or return to Measurement mode by pressing Δ and ▽ keys simultaneously (escape).



7.6.5 Wash Contact (if the relay 3 is set to Wash)



- 1) Follow directions in 7.6.1 to enter Configuration mode. Press the ENTER key when choosing CLn.
- 2) Press the Δ or ▽ keys to select the wash cycle (int. 0.1 to 199.9 hours).
- 3) Press the ENTER key to confirm your selection.
- 4) Press the Δ or ▽ keys to select the wash duration (1 to 1999 seconds) and press ENTER to confirm.
- 5) Proceed to 7.6.6, or return to Measurement mode by pressing the Δ and ▽ keys simultaneously.

7.6.6 Input Line Resistance Adjust

This function compensates for the line resistance of the cable to its cell.

- 1) **Follow directions in 7.6.1** to enter Configuration mode.
- 2) **Press ENTER key** until upper display shows "0.0" and lower display shows "L.Ad". L.Ad = line adjuster resistance (0.0 to 100.0)
- 3) **Press Δ or ▽ keys** to input value. **Press ENTER key**.
- 4) **Proceed to 7.6.7**, or return to Measurement mode by pressing **Δ and ▽ keys** simultaneously (escape).

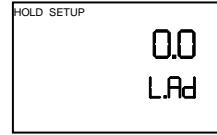

7.6.7 Reverting to factory default settings

Use this parameter to reset all settings or calibration values only to factory default. Changing from "no" to "YES" and pressing the ENTER key resets all settings to factory reset.



- 1) **Follow directions in 7.6.1** to enter Configuration mode.
- 2) **Press the ENTER key**. The upper display shows "no" or "YES", the lower display shows "deF" (default).
- 3) **Press the Δ or ▽ keys** to select "no" or "YES". **WARNING: Press the ENTER key resets all settings and the calibration values will be overwritten as a result!**
- 4) **Press the ENTER key** to confirm your selection and to return to Advanced Set-up mode, or return to Measurement mode by pressing the **Δ or ▽ keys** simultaneously (escape).

7.7 Calibration (CAL) sub-function

The calibration procedure in Advanced Set-up mode is identical to procedure in Calibration mode. The only difference is that the controller will revert back to Set-up mode (instead of Measurement mode) after successful calibration.

7.7.1 Entering Calibration mode from Advanced Set-up mode

- 1) **Enter Advanced Set-up mode**. Push ENTER key and scroll to Advanced Set-up security code "22". Push ENTER key again.
- 2) **Press Δ or ▽ keys** to scroll until upper display shows "CAL". See section 6 for complete calibration procedures.

8 Auto/Manual Mode

Regardless of mode, control devices connected to Relay A or Relay B can be operated from front panel of controller. In Automatic mode, controller's set point values activate relays. In Manual mode, manual control of relays is possible to prime the pump or check pump status.

8.1 Auto mode (mode after switch-on)

To view set-point values:

- 1) Press **RELAY SELECTION (Rel A/Rel B)** key. Upper display shows set-point value for Relay A; lower display shows "SP1".
- 2) After two seconds upper display shows set-point value for Relay B; lower display shows "SP2".
- 3) After an additional two seconds controller returns to Measurement mode.

8.2 Manual mode

- 1) Press **RELAY CONTROL (auto/manu)** key. Upper display shows "000"; lower display shows "S.Cd" to prompt to enter Advanced Set-up code.
- 2) Press **Δ** or **∇** keys to scroll upper display until it reads "22".
- 3) Press **ENTER** key. Manual indicator by the RELAY CONTROL key lights up.

Note: Pressing **ENTER** key at a value other than "22" will cause controller to revert to Measurement mode, and relays will remain in automatic mode.

- 4) Press **RELAY SELECTION** key to select either Relay A or Relay B. LED next to currently selected relay (A or B) will light.

The manual control options are now available.

- **Limit control** selected: Upper display reads current measured value. Lower display shows "oFF" or "on" depending on relay status of currently selected relay.
- 5) Press **Δ** or **∇** keys to change Relay on/off status. LED indicators at the right of controller will also change between Red and Green to indicate Relay status.

Note: If you wish to manually change the status of both relays, press **RELAY SELECTION** key at this point and repeat step 5 for second relay. This first relay will remain under manual control while you are setting the second relay.

- 6) Press **RELAY CONTROL** key to return to Measurement mode. Relays are now back under automatic control.

9 Technical Specifications

Resistivity Range	Resolution	Default Cell Constant, K
0.00 to 19.99 mΩ/cm	0.01 mΩ/cm	0.01
0.000 to 1.999 mΩ/cm	0.001 mΩ/cm	0.1
Temperature		
Temperature		-9.9 to 125 °C
<i>Resolution</i>		0.1 °C
<i>Relative Accuracy</i>		± 0.5 °C
Sensor		Pt 1000/Pt 100
Temperature Compensation		Auto / manual (reference at 25.0 °C)

Set-point and Controller Functions

Controller characteristics	Limit/Proportional controller
Pickup / Dropout delay	0 to 1999 sec.
Switching Conductivity hysteresis	0 to 10% of Full Scale
Contact outputs, controller	2 potential-free change-over contacts
Switching voltage	max. 250 VAC
Switching current	max. 3A
Switching power	max. 600 VA

Alarm/Wash Functions

Function (switchable)	Latching / pulse
Pickup delay	0 to 1999 sec.
Switching voltage	max. 250 VAC
Switching current	max. 3A
Switching power	max. 600 VA

Electrical Data and Connections

Power Requirements	110 / 220 VAC (jumper selectable)
Frequency	48 to 62 Hz
Signal Output	0/4 to 20 mA, galvanically isolated
Signal Output Load	max. 600 Ω
Connection terminal	Terminal blocks 5-pole / 17-pole, removable
Mains fuse / fine wire fuse	slow-blow 250 V / 100 mA

EMC Specifications

Emissions	According to EN 50081-1
Susceptibility	According to EN 50082-1

Environmental Conditions

Ambient temp. operating range	0 to 50 °C
Relative humidity	10 to 95%, non-condensing

Mechanical Specifications

Dimensions (control panel housing - L x H x W)	175 x 96 x 96 mm
Weights (control panel housing)	max. 0.7 kg
Material	ABS with polycarbonate (front housing)
Insulation (Front / Housing)	IP 54 / IP 65

Accessories

Assembly Accessories

Product Description	Code no.
Resistivity Cell, up to 20mΩ; Cell constant, K=0.01 with integrated Pt 100, Material SS316 and 25ft cable (open-ended)	EC-CS10-0-01S
Resistivity Cell, up to 20mΩ; Cell constant, K=0.01 with integrated Pt 100, Material Titanium and 25ft cable (open-ended) – Ultrapure water applications	EC-CS10-0-01T
Resistivity Cell, 0.10 – 2.00mΩ; Cell constant, K=0.1 with integrated Pt 100, Material SS316 and 25ft cable (open-ended)	EC-CS10-0-1S

Note: Above Resistivity Cells can has a pressure tolerance of up to 6 bar. Please ask your authorised distributor or dealer for prices.

10 General Information

Thermo Scientific Instruments warrants this product to be free from significant deviations in material and workmanship for a period of one year from the date of purchase. If repair is necessary and has not been the result of abuse or misuse within the warranty period, please return by freight pre-paid and amendment will be made without any charge. Thermo Scientific Instruments' Customer Service Dept. will determine if product problem is due to deviations or customer abuse. Out of warranty products will be repaired on a charge basis.

10.1 Packaging

The instrument is packaged in a corrugated box with a warranty card, instruction manual and the following accessories:

- 17-way and 5-way (right-angled) terminal block [1 unit each]
- side threaded rod with catch [2 units]
- receptacle cable lug [1 unit]
- rubber gasket [1 unit]

10.2 Return of Goods

Authorisation must be obtained from Thermo Scientific Instruments' Customer Service Dept. to issue a RGA (Return of Goods Authorisation) number before returning items for any reason. When applying for authorisation, please include data requiring the reason of return. Items must be carefully packed to prevent damage in shipment and insured against possible damage or loss. Thermo Scientific Instruments will not be responsible for any damage resulting from careless or insufficient packing.

Warning: Shipping damage as a result of inadequate packaging is the user/distributor's responsibility, whoever applicable. Please follow the guidelines below before shipment.

10.3 Guidelines for Returning Unit for Repair

Use the original packaging material, if possible when shipping the unit for repair. Otherwise wrap it with bubble pack and use a corrugated box for better protection. Include a brief description of any faults suspected for the convenience of Customer Service Dept., if possible.

11 Appendices

Appendix 1 – Jumper Positions

Jumper Positions - Internal to the controller

JP 1	Selects the input voltage 220 VAC.
JP 2	Selects the input voltage 110 VAC.
JP 6	Selects the temperature sensor for Pt1000/Pt100
Fuse	Note that there is a fuse (slow-blow 100mA) internal to the controller. Before opening the unit, ENSURE that the power cable is physically separated from the power supply. Replace fuse with the recommended type only.

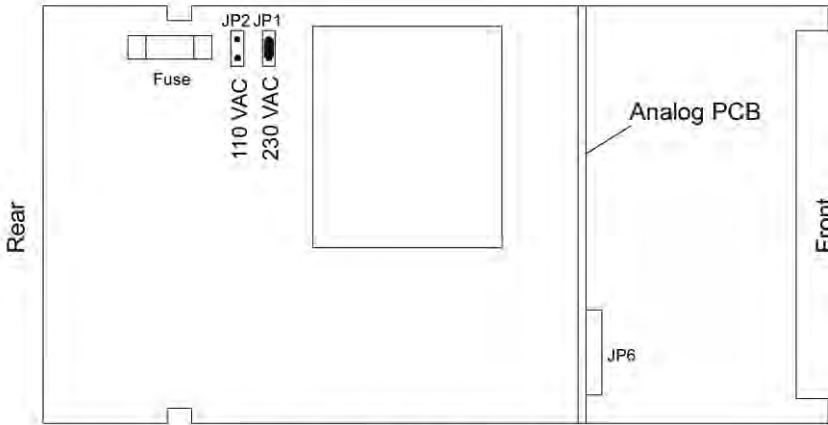

View from the top of Main PCB

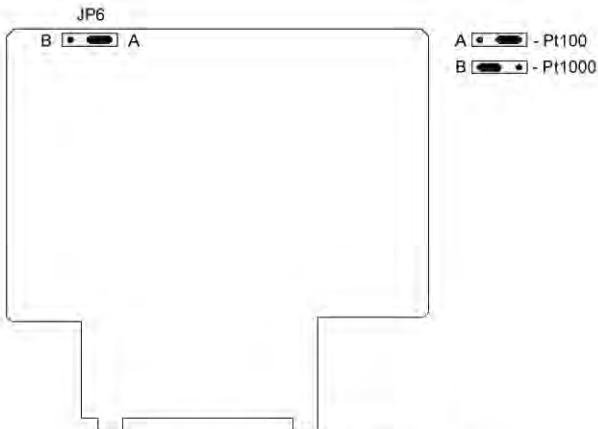

View from the front of the Analog PCB

Appendix 2 – Conductivity / Resistivity of Various Aqueous Solutions at 25°C

	Conductivity		Resistivity	
Pure Water	0.05	uS/cm	18	MΩ-cm
Power Plant Boiler Water	0.05 - 1	uS/cm	1 - 18	MΩ-cm
Distilled Water	0.5	uS/cm	2	MΩ-cm
De-ionized Water	0.1 - 10	uS/cm	0.1 - 10	MΩ-cm
De-mineralised Water	1 - 80	uS/cm	0.01 - 1	MΩ-cm
Mountain Water	10	uS/cm	0.1	MΩ-cm
Drinking Water	0.5 - 1	mS/cm	1 - 2	MΩ-cm
Waste-water	0.9 - 9	mS/cm	0.1 - 1	MΩ-cm
Potable Water Maximum	1.5	mS/cm	0.7	MΩ-cm
Brackish Water	1 - 80	mS/cm	0.01 - 1	MΩ-cm
Industrial Process Water	7 - 140	mS/cm	rarely stated	
Ocean Water	53	mS/cm	rarely stated	

Appendix 3 - Simple Explanation on the Function of Hysteresis

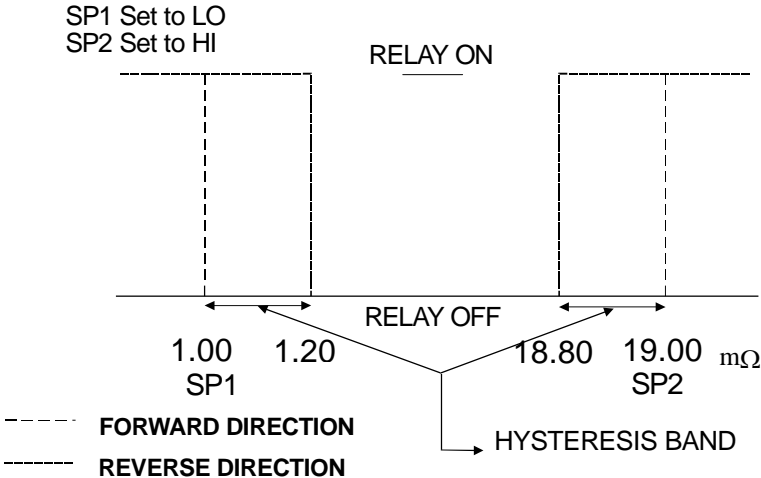

The controller relay activates when the set-point is reached. In the reverse direction, it does not de-activate when the value reaches the set-point. Instead, it continues to be active till the value reaches the amount set by the Hysteresis band.

Appendix 4 – Pure Water Curve

Resistivity of Pure Water

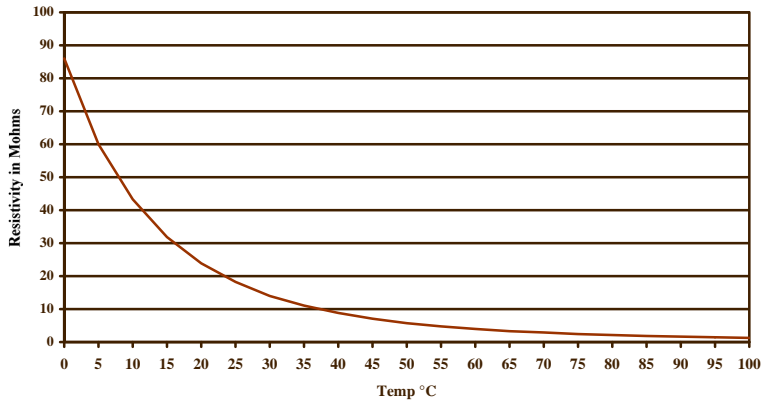

Water Analysis Instruments



North America

166 Cummings Center
Beverly, MA 01915 USA
Toll Free: 1-800-225-1480
Tel: 1-978-232-6000
Dom. Fax: 1-978-232-6015
Int'l Fax: 978-232-6031

Europe

P.O. Box 254, 3860 AG Nijkerk
Wallerstraat 125K, 3862 CN Nijkerk,
Netherlands
Tel: (31) 033-2463887
Fax: (31) 033-2460832

Asia Pacific

Blk 55, Ayer Rajah Crescent
#04-16/24, Singapore 139949
Tel: 65-6778-6876
Fax: 65-6773-0836

www.thermo.com/process

© 2009 Thermo Fisher Scientific Inc.

All rights reserved. Thermo Fisher Scientific Inc.