

DigitalFlow™ GF868

Ultrasonic flare gas mass flowmeter

Programming manual (2-channel)

BH015C32 EN G



[no content intended for this page]

DigitalFlow™ GF868

Ultrasonic flare gas mass flowmeter

Programming manual (2-channel)

BH015C32 Rev. G
April 2024

[no content intended for this page]

Contents

Chapter 1. Programming site data	11
1.1 Introduction	11
1.2 Using the keypad	11
1.3 Obtaining on-line help	14
1.4 Using the console control keys	14
1.4.1 Audio alarm volume	14
1.4.2 Stopwatch totalizer.....	14
1.4.3 Display brightness	14
1.4.4 Display contrast.....	14
1.5 The user program	15
1.5.1 Entering programming mode.....	15
1.6 Entering channel data	16
1.6.1 Activating a channel.....	16
1.6.2 Entering system data for a channel.....	17
1.6.3 Entering pipe data	18
1.6.4 Setting up inputs/outputs.....	19
1.6.5 Entering setup data	21
1.7 Entering global data	25
1.7.1 Setting the clock	25
1.7.2 Entering global system data	26
1.7.3 Setting up global inputs/outputs.....	27
1.7.4 Setting up communications	30
1.7.5 MODBUS register map.....	31
1.7.6 Activating security	34
1.8 Saving site files	35
1.9 Recalling site files	35
Chapter 2. Displaying data	37
2.1 Introduction	37
2.2 The BIG submenu	38
2.3 The DUAL submenu	38
2.4 The GRAPH submenu	39
2.4.1 Setting up the GRAPH Format	39
2.4.2 Using the GRAPH format.....	39

2.5	The LOG submenu	40
2.5.1	Entering the LOG submenu	40
2.5.2	Numeric format	40
2.5.3	Graphical format	41
2.6	Displaying the transducer signal	42
2.7	Setting the LCD backlight	44
2.8	Activating sleep mode	44
 Chapter 3. Logging data		 45
3.1	Introduction	45
3.2	Creating a standard log	46
3.2.1	Log type	47
3.2.2	STARTTIME prompt	47
3.2.3	START DATE prompt	47
3.2.4	END TIME prompt	47
3.2.5	END DATE prompt	47
3.2.6	DURATION prompt	48
3.2.7	LOG TIME prompt	48
3.2.8	TIME INCREMENT prompt	48
3.3	Checking the memory	49
3.4	Stopping a log	49
3.5	Creating an ERROR log	50
3.5.1	Log type	51
3.5.2	STARTTIME prompt	51
3.5.3	START DATE prompt	51
 Chapter 4. Printing data		 52
4.1	Introduction	52
4.2	Print live data	53
4.2.1	Numeric format	53
4.2.2	Graphical format	54
4.3	Printing logs	55
4.3.1	Numeric format	55
4.3.2	Graphical format	55
4.4	Print site file	56
4.5	Stop printing	56
4.6	Setting up a printer	57

4.7	Printing signal array data	57
4.8	Printing RTD data	58
Chapter 5. Clearing data		59
5.1	Introduction	59
5.2	Reset totals	59
5.3	Deleting site files	60
5.4	Deleting log files	60
Chapter 6. Serial communications		61
6.1	Introduction	61
6.2	Wiring the RS232 interface	62
6.3	Checking the GF868 baud rate	62
6.4	Setting up the terminal software	63
6.4.1	Windows 3.X systems	63
6.4.2	Windows 9X/NT systems	63
6.5	The optional RS485 serial interface	64
6.5.1	Interface converter mounting	64
6.5.2	Point-to-point wiring	64
6.5.3	Multi-point wiring	64
6.6	Setting up an Ethernet connection	66
6.7	Setting up a MODBUS/TCP connection	66
Appendix A. Menu maps		67
Appendix B. Data records		74
B.1	Option cards installed	74
B.2	Initial setup data	75
Appendix C. Programming with PanaView		77
C.1	Introduction	77
C.2	Wiring the RS232 interface	77
C.3	Setting up the communications port	78
C.3.1	Setting up Ethernet communications	78

C.4 Adding the GF868	79
C.5 Editing meter properties	80
C.5.1 Setting the meter clock	80
C.5.2 Reading transducer signals	81
C.5.3 Plotting transducer signals	81
C.5.4 Saving transducer signals	81
C.5.5 Clearing totalizers	81
C.5.6 Handling site files	82
C.6 Changing meter settings	84
Appendix D. Foundation fieldbus communications	86
D.1 Optional measurements	86
D.2 Configuration utility setup	87
D.3 Selecting the desired measurements	87
D.4 Selecting units for AI blocks	88
D.5 Resetting Instrument totalizers	88
D.6 Function block application	89
Appendix E. Foundation fieldbus tables	90
Special conditions for safe use	105
Markings	105
EU / EEA installation compliance	105
Increased safety wiring connections	105
Power connection:	105
All other screw terminal connections:	105

Information paragraphs

NOTE:

These paragraphs provide information that provides a deeper understanding of the situation, but is not essential to the proper completion of the instructions.

IMPORTANT:

These paragraphs provide information emphasizing instructions which are essential to proper setup of the equipment. Failure to follow these instructions carefully may cause unreliable performance.



WARNING!

Indicates a potentially hazardous situation which can result in serious personal injury or death, if it is not avoided.



CAUTION!

Indicates a potentially hazardous situation which can result in minor or moderate injury to personnel or damage to the equipment, if it is not avoided.



HIGH VOLTAGE!

This symbol indicates the presence of high voltage. It calls your attention to situations or operations that could be dangerous to you and other persons operating the equipment. Read these messages and follow the instructions carefully.

Safety issues

WARNING!



It is the responsibility of the user to make sure all local, county, state and national codes, regulations, rules and laws related to safety and safe operating conditions are met for each installation.

Auxiliary equipment

Local safety standards

The user must make sure that he operates all auxiliary equipment in accordance with local codes, standards, regulations, or laws applicable to safety.

Working area

WARNING!



Auxiliary equipment may have both manual and automatic modes of operation. As equipment can move suddenly and without warning, do not enter the work cell of this equipment during automatic operation, and do not enter the work envelope of this equipment during manual operation. If you do, serious injury can result.

WARNING!



Make sure that power to the auxiliary equipment is turned OFF and locked out before you perform maintenance procedures on the equipment.

Qualification of personnel

Make sure that all personnel have manufacturer-approved training applicable to the auxiliary equipment.

Personal safety equipment

Make sure that operators and maintenance personnel have all safety equipment applicable to the auxiliary equipment. Examples include safety glasses, protective headgear, safety shoes, etc.

Unauthorized operation

Make sure that unauthorized personnel cannot gain access to the operation of the equipment.

Environmental compliance

Waste Electrical and Electronic Equipment (WEEE) directive

Panametrics is an active participant in Europe's Waste Electrical and Electronic equipment (WEEE) take-back initiative, directive 2012/19/EU.



The equipment that you bought has required the extraction and use of natural resources for its production. It may contain hazardous substances that could impact health and the environment.

In order to avoid the dissemination of those substances in our environment and to diminish the pressure on the natural resources, we encourage you to use the appropriate take-back systems. Those systems will reuse or recycle most of the materials of your end life equipment in a sound way.

The crossed-out wheeled bin symbol invites you to use those systems.

If you need more information on the collection, reuse and recycling systems, please contact your local or regional waste administration.

Chapter 1. Programming site data

1.1 Introduction

The 2-channel model GF868 flowmeter cannot provide accurate flow rate measurements for either channel until the instrument has been properly installed, the channel has been activated, and the basic system and pipe parameters have been programmed into the meter. See the *startup guide* for detailed instructions on performing these tasks. After completing the installation, proceed with this chapter to program the model GF868's advanced features.

IMPORTANT:

If you are using PanaView™ software to program the GF868, refer to Appendix C.

Four submenus within the *user program* provide access to the various programmable features of the model GF868. Step-by-step programming instructions for each submenu are presented in this chapter. Refer to the appropriate section for a discussion of the following *user program* submenus:

- **CHI/CH2** - use this submenu to activate a channel and to enter the basic setup parameters for that channel.
- **GLOBL** - use this submenu to enter global meter parameters (i.e., clock, system, input/output, communications and security), which apply to both channels.
- **SAVE** - use this submenu to store both channel and global data in the meter's memory, as a site file.
- **RECLL** - use this submenu to recall and activate a stored site file.

NOTE:

It is not required that both channels of a 2-channel model GF868 be installed. The second channel connector may simply be left vacant for future expansion.

As an aid in following the programming instructions, a complete menu map of the *user program* is included in Appendix A, *menu maps*.

NOTE:

In the menu map drawings, plain text represents prompt area messages and boxed text represents option bar choices. Fx represents a function key to select an option bar choice.

1.2 Using the keypad

The model GF868 keypad contains 39 keys, which are labeled with their primary (unshifted) functions. In addition, pressing the red [SHIFT] key will access the secondary functions assigned to most of the keys.

The complete keypad is illustrated in figure 1 and a detailed description of both the unshifted and shifted functions for each of the 39 keys is listed in Table 1.

NOTE:

Only the [SHIFT] key and the eight [Fx] keys have no shifted function.

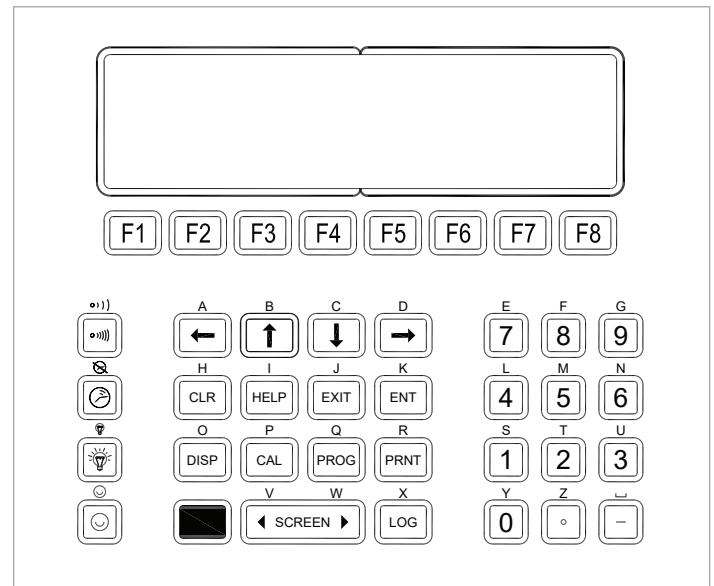

Figure 1: Model GF868 keypad

NOTE:

Although the keypad is essentially the same, the front panel layout of meters supplied in one of the optional enclosures is different. See Appendix C, *optional enclosures*, of the *startup guide* for a picture of the applicable front panel.

Table 1: Model GF868 key functions



Key	Unshifted function	Shifted function
	<p>Software function keys – press to select the functions displayed directly above them in the option bar. These keys apply only to the left pane of the display screen.</p>	None
		
		
		
	<p>Software function keys – press to select the functions displayed directly above them in the option bar. These keys apply only to the right pane of the display screen.</p>	None
		
		
		
	<p>Shift key – use this red key to access the shifted function of the other keys. One press shifts the next keystroke only, while two presses locks the keypad in shifted mode. A third press releases the shift function.</p>	None
	<p>Arrow keys – in measurement mode, use to scroll through function choices on the option bar. In programming mode, use to scroll through menu choices. The [←] also acts as a backspace key in programming mode.</p>	Use to enter the letters A, B, C and D, respectively.
		
		
		
	<p>Program key – press to enter the <i>user program</i>. See 1.5 The user program for details.</p>	Use to enter the letter Q.

Table 1: Model GF868 key functions









Key	Unshifted function	Shifted function
	<p>Display key – use to display data in a variety of numeric and graphic formatting options. See Chapter 2. Displaying data for details.</p>	Use to enter the letter O.
	<p>Log key – use to set up logs. See Chapter 3. Logging data for details.</p>	Use to enter the letter X.
	<p>Print key – use to print live measurements, log files and signal arrays. See Chapter 4. Printing data for details.</p>	Use to enter the letter R.
	<p>Clear key – use to reset totals and to delete site and log files from the model GF868 memory. See Chapter 5. Clearing data for details.</p>	Use to enter the letter H.
	<p>Calibration key – use to calibrate the analog inputs and outputs and to test the alarm relays and the totalizer/frequency outputs. See chapter 1, calibration, in the service manual for details.</p>	Use to enter the letter P.
	<p>Exit key – use to move up one level in the <i>user program</i> or to exit the <i>user program</i>. See this chapter for details.</p>	Use to enter the letter J.
	<p>Enter key – use to confirm the most recent input information.</p>	Use to enter the letter K.
	<p>Help key – use to access the model GF868’s context-sensitive on-line help system. See the next section for details.</p>	Use to enter the letter I.

Table 1: Model GF868 key functions

















Key	Unshifted function	Shifted function
	Screen key - press the left side to select the left display pane or press the right side to select the right display pane.	Press the left side to enter the letter V or press the right side to enter the letter W.
	Decimal point key - press to enter a decimal point during numeric entry.	Use to enter the letter Z.
	Minus key - use to enter a minus sign or a dash.	Use to enter a space character.
	Zero key - use to enter the number 0.	Use to enter the letter Y.
	One key - use to enter the number 1.	Use to enter the letter S.
	Two key - use to enter the number 2.	Use to enter the letter T.
	Three key - use to enter the number 3.	Use to enter the letter U.
	Four key - use to enter the number 4.	Use to enter the letter L.
	Five key - use to enter the number 5.	Use to enter the letter M.
	Six key - use to enter the number 6.	Use to enter the letter N.

Table 1: Model GF868 key functions

Key	Unshifted function	Shifted function
	Seven key - use to enter the number 7.	Use to enter the letter E.
	Eight key - use to enter the number 8.	Use to enter the letter F.
	Nine key - use to enter the number 9.	Use to enter the letter G.
	Audio level key - press to increase the audio alarm volume.	Press to decrease the audio alarm volume.
	Stopwatch timer key - press to turn the stopwatch timer on.	Press to turn the stopwatch timer off.
	Backlight key - press to turn the display backlight on or to increase its brightness.	Press to turn the display backlight off or to decrease its brightness.
	Contrast key - press to increase the contrast of the display screen.	Press to decrease the contrast of the display screen.

1.3 Obtaining on-line help

A context-sensitive, on-line help system is programmed into every model GF868 flowmeter. On-line help, which displays additional information related to the current task, may be accessed at any time by pressing the [HELP] key on the keypad. The help information will be shown on the currently selected pane of the display screen, as shown in figure 2.

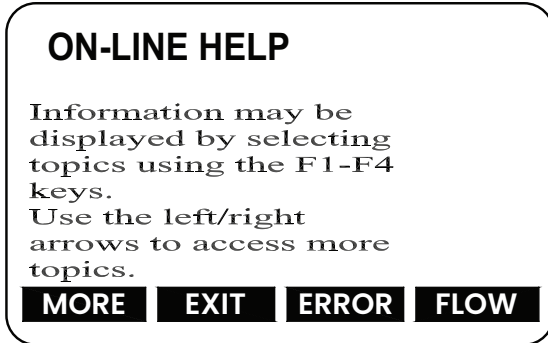

Figure 2: Typical on-line help screen

After entering the on-line help system, the following functions are available on the option bar of the selected display pane:

- **MORE:** Press [F1] (or [F5]) to access this function, and the next screen of text is displayed in the prompt area.
- **EXIT:** Press [F2] (or [F6]) to access this function, and the model GF868 returns to measurement mode.
- **ERROR:** Press [F3] (or [F7]) to access this function, and the various model GF868 error codes are displayed. Use the [F1]-[F4] (or [F5]-[F8]) function keys, in conjunction with the [←] and [→] keys, to obtain additional information on the desired error code or to exit the help system.

NOTE:

See the *service manual* for a complete listing of all error codes and messages.

- **FLOW:** Press [F4] (or [F8]) to access this function, and the various flow measurement parameters are displayed. Use the [F1]-[F4] (or [F5]-[F8]) function keys, in conjunction with the [←] and [→] keys, to obtain additional information on the desired measurement parameter or to exit the help system.

1.4 Using the console control keys

The model GF868 has four console control keys, which are located on the left side of the keypad. Use these keys, which are described and pictured in table 1, in accordance with the following instructions:

1.4.1 Audio alarm volume

Use the top console control key to adjust the audio alarm volume.



Discrete presses will incrementally increase the volume of the audio alarm. Hold the key down for continuous increase. Use the key in shifted mode to decrease the volume of the audio alarm.

1.4.2 Stopwatch totalizer

Use the second console control key for the stopwatch totalizer.



Press the key once to start the stopwatch totalizer. Press the key once, in shifted mode, to stop the stopwatch totalizer.

NOTE:

Instructions on properly setting up the stopwatch totalizer are given later in this chapter. Also, the service manual provides information on the error response of the stopwatch totalizer.

1.4.3 Display brightness

Use the third console control key to adjust the display backlight.



Discrete presses of this key will increase the backlight brightness through settings of off, mid and full. Discrete presses of this key in shifted mode, will decrease the backlight brightness through settings of full, mid and off.

NOTE:

The display backlight has an automatic time-off feature. See 2.7 Setting the LCD backlight for details.

1.4.4 Display contrast

Use the bottom console key to adjust the display contrast.



Discrete presses will incrementally increase the display contrast. Hold the key down for continuous increase. Use the same key, in shifted mode, to decrease display contrast.

1.5 The user program

Use the keypad, as described in chapter 3, *operation*, of the *startup guide* to navigate through the *user program*. The menu maps in Appendix A may be followed in sequence, or the [↑] and [↓] keys may be used to scroll through the prompt screens. The [←] key may be used to delete the last alphanumeric character that was entered from the keypad.

The following discussion assumes that the left screen pane is active. If the right screen pane is active, only the function key designations change. That is, replace [F1]–[F4] with [F5]–[F8]. Also, **channel 1** is used in all examples, but the instructions apply equally to **channel 2**.

NOTE:

Be sure to record all the programming data entered in this chapter in Appendix B, *data records*.

Programming of the ACTIV, SYSTM (ch1 and GLOBL) and PIPE submenus is necessary for operation of the model GF868. Failure to accurately enter all of the required information will result in unreliable flow rate data. Therefore, be sure to complete at least the sections of this chapter pertaining to those three submenus.

NOTE:

Because it is so essential, instructions for programming the ACTIV, SYSTM and PIPE submenus are also included in the *startup guide*. If that programming has already been completed, skip the corresponding sections of this chapter.

Except for the three submenus noted above, it is not necessary to program the model GF868 flowmeter in any particular order. Therefore, the sections of this chapter need not be completed in sequence. Proceed immediately to any section of interest.

1.5.1 Entering programming mode

To access the *user program*, press the [PROG] key on the keypad. The standard measurement mode screen will be replaced by the following initial programming mode screen:

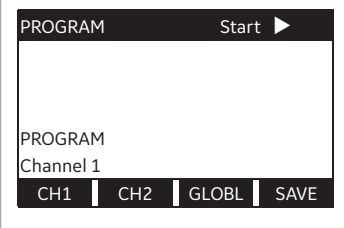

Press the [←] and [→] keys and one of the function keys [F1]–[F4] to select the desired submenu. From this screen, press [EXIT] to return to measurement mode.

NOTE:

If the security feature is active, enter the password and press the [ENT] key to enter the *user program*. See the SECUR submenu section of this chapter for more information on the security feature.

1.6 Entering channel data

After selecting [F1]=CH1 (or [F2]=CH2) at the initial programming screen, the following screen appears:

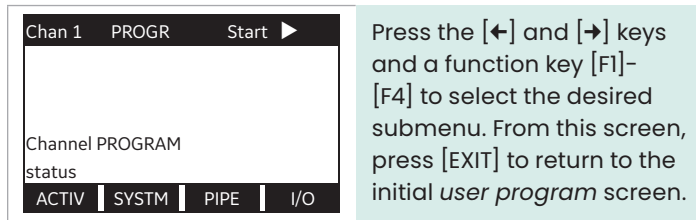

Based on the selection made above, proceed to the appropriate section of this chapter for instructions.

1.6.1 Activating a channel

The ACTIV submenu activates a channel and selects the desired measurement method.

1. To enter the channel PROGRAM menu, press [F1] or [F2] (depending on the desired channel) at the *user PROGRAM* prompt.
2. Enter the ACTIV submenu by pressing [F1] at the channel PROGRAM prompt.
3. Press [F1] (OFF) to deactivate the channel and return to the channel PROGRAM prompt, or press [F2] to activate the channel in BURST mode.
4. Press [F1] to select skan mode or [F2] to select skan/measure mode. The meter will exit the ACTIV submenu and return to the channel menu screen.

As indicated in the above prompt, the model GF868 flowmeter can take measurements in two different ways:

- **Skan** is the preferred technique for locating the acoustic signal and for high velocity measurements. It is more robust in a noisy environment than the measure technique.
- **Measure** is the preferred technique to use for making low velocity measurements.

If Skan is selected at the next prompt, the instrument uses this technique exclusively. However, if S/M is selected, the meter uses skan to find the acoustic signal and then tries to use the measure technique for a more precise measurement.

NOTE:

To change the skan and measure parameters, see the SIGNAL submenu section.

1.6.1a Procedure options

After completing the above steps, the meter returns to the channel PROGRAM prompt. Continue as follows:

- To continue programming the meter, refer to the menu maps in Appendix A and navigate to the desired menu. Then, proceed to the appropriate section of this manual for instructions.
- To leave the *user program* and retain the previous settings, press [EXIT] twice and then press [F1] = NO at the SAVE prompt. Any programming changes will be discarded and you will be returned to the data display.
- To leave the *user program* and return to measurement mode, press [EXIT] twice and then press [F2] = YES at the SAVE prompt. Your programming changes will be entered into the meter's memory, and you will be returned to the data display.

NOTE:

See the SAVE submenu section for more information on this function.

1.6.2 Entering system data for a channel

Refer to figure 11.

1. To enter the channel PROGRAM menu, press [F1] or [F2] (depending on the desired channel) at the *user PROGRAM* prompt.
2. To program the SYSTM submenu, press [F2] at the channel PROGRAM prompt.

IMPORTANT:

Do not confuse this SYSTM submenu, which is used to enter channel-specific information, with the SYSTM submenu of the GLOBL menu, which is used to enter information applicable to both channels.

3. Enter a *channel label* of up to 9 characters. Press [ENT].
4. Enter a *channel message* of up to 21 characters. Press [ENT].
5. Use the [→] and [F1]-[F4] keys to select the volumetric units for the data display, as shown in table 2.

Table 2: Available volumetric/totalizer units

English	Metric
Actual units	
ACF = Actual cubic feet	ACM = Actual cubic meters
KACF = Thousands of ACF	KACM = Thousands of ACM
MMACF = Millions of ACF	MMACM = Millions of ACM
Standard units	
SCF = Standard cubic feet	SCM = Standard cubic meters
KSCF = Thousands of SCF	KSCM = Thousands of SCM
MMSCF = Millions of SCF	MMSCM = Millions of SCM

6. Use the [F1]-[F4] keys to select the *volumetric time* for the data display.
7. Use the [F1]-[F4] keys to select the *vol decimal digits* (the number of digits to the right of the decimal point) in the data display.
8. Use the [→] and [F1]-[F4] keys to select the *totalizer units* for the data display.
9. Use the [F1]-[F4] to select the *total decimal digits* (the number of digits to the right of the decimal point) in the data display.

10. Use the [F1]-[F4] keys to select the *mass flow units* for the data display, as shown in table 3.

Table 3: Available mass flow units

English	Metric
LB = Pounds	KG = Kilograms
KLB = Thousands of LB	TONNE = Metric tons (1000 KG)
MMLB = Millions of LB	
TONS = Tons (2000 LB)	

11. Use the [F1]-[F4] keys to select the *mass flow time* units for the data display.
12. Use the [F1]-[F4] to select the *MDOT decimal digits* (the number of digits to the right of the decimal point) in the data display.
13. Use the [F1]-[F4] to select the *mass (totalizer)* for the data display.
14. Use the [F1]-[F4] to select the *mass decimal digits* for the data display.

1.6.2a Procedure options

After completing the above steps, the meter returns to the channel PROGRAM prompt. Continue as follows:

- To continue programming the meter, refer to the menu maps in Appendix A and navigate to the desired menu. Then, proceed to the appropriate section of this manual for instructions.
- To leave the *user program* and retain the previous settings, press [EXIT] twice and then press [F1] = NO at the SAVE prompt. Any programming changes will be discarded and you will be returned to the data display.
- To leave the *user program* and return to measurement mode, press [EXIT] twice and then press [F2] = YES at the SAVE prompt. Your programming changes will be entered into the meter's memory, and you will be returned to the data display.

1.6.3 Entering pipe data

To program the transducer and pipe parameters via the PIPE submenu, complete the following steps and refer to figure 11.

1. To enter the channel PROGRAM menu, press [F1] or [F2] (depending on the desired channel) at the user PROGRAM prompt.
2. Press [F3] at the channel PROGRAM prompt.
3. Enter the *transducer number* (normally engraved on the head of the transducer). Press [ENT]. If there is no engraved number, complete the steps below. Otherwise, proceed to step 4.

IMPORTANT:

Special transducers, which have no engraved number on the head, are rarely used. Examine the transducer head carefully for a number.

1.6.3a Special transducers

- a. Assign a number between 91 and 99 to the *special transducer* and press [ENT]. (The meter will only accept values from 1 to 199.)
- b. Use the [→] and [F1]–[F4] keys to select the *frequency* of the special transducer. The meter can not transmit an excitation voltage at the transducer’s natural frequency without this data.
- c. Enter the special transducer *time delay* (T_w) value supplied by the factory. Press [ENT]. (The meter will only accept values from 0 to 1000 μ sec.)

NOTE:

T_w is the time required for the transducer signal to travel through the transducer and its cable. This time delay must be subtracted from the transit times of the upstream and downstream transducers to ensure an accurate measurement.

1.6.3b Pipe OD

4. Enter the known *pipe OD* or circumference and use the [F1]–[F4] keys to select the appropriate units. Press [ENT]. (The meter will accept values only from 1/8 to 648 in.)

Table 4: Available pipe OD units

English	Metric
inch = pipe OD in inches	mm = pipe OD in millimeters
feet = pipe OD in feet	m = pipe OD in meters
in/PI = pipe circumference in inches	mm/PI = pipe circumference in millimeters
ft/PI = pipe circumference in feet	m/PI = pipe circumference in meters

The required pipe data may be obtained by measuring either the pipe outside diameter (OD) or circumference at the transducer installation site. Alternatively, the information may be obtained from tabulated data for standard pipe sizes.

1.6.3c Pipe wall

5. Enter the known thickness of the *pipe wall*, in the same units used for the pipe OD. Press [ENT]. (The meter will only accept values from 0 to 4 in.)

If the pipe wall thickness is not known and cannot be conveniently measured, look up the value in a table of standard pipe size data or use the model GF868’s on-line help menu.

1.6.3d Path length

6. Press [F1] = inch or [F2] = feet to select the units. Then, enter the *path length* (P) of the ultrasonic signal. Press [ENT]. (The meter will only accept values from 1/8 to 900 in.)

NOTE:

The factory has calculated both the transducer signal path length (P) and the transducer signal axial length (L), based on the exact transducer configuration used for the application. These values are engraved on the flowcell and/or are included in the documentation supplied with the meter.

1.6.3e Axial length

- Press [F1] = inch or [F2] = feet to select the units. Then, enter the *axial length (L)* of the ultrasonic signal and press [ENT].

1.6.3f Reynolds correction

- Press [F1] to turn *Reynolds correction* off, or [F2] to turn it on.

NOTE:

Reynolds correction is a number based on the Kinematic Viscosity and flow rate of the fluid. It should be enabled for most applications.

- When you enable the Reynolds correction factor, you must also enter the *kinematic viscosity* of your gas, as listed in *sound speeds and pipe size data*. Use the numeric keys to enter a value, and press [ENT].

1.6.3g Calibration factor

- Enter a value for the flow *calibration factor* and press [ENT]. The default value is 1.00. (The meter will only accept values from 0.5000 to 2.0000.)

1.6.3h Procedure options

After completing the above steps, the meter returns to the channel PROGRAM prompt. Continue as follows:

- To continue programming the meter, refer to the menu maps in Appendix A and navigate to the desired menu. Then, proceed to the appropriate section of this manual for instructions.
- To leave the *user program* and retain the previous settings, press [EXIT] twice and then press [F1] = NO at the SAVE prompt. Any programming changes will be discarded and you will be returned to the data display.
- To leave the *user program* and return to measurement mode, press [EXIT] twice and then press [F2] = YES at the SAVE prompt. Your programming changes will be entered into the meter's memory, and you will be returned to the data display.

1.6.4 Setting up inputs/outputs

The following specific tasks may be performed via the I/O submenu:

- Enter a zero cutoff value to eliminate low flow reading fluctuations
- Set up any optional temperature and/or pressure inputs. Refer to the menu map in figure 12.

NOTE:

Remember to record all programmed data in Appendix B, *data records*.

- To enter the channel PROGRAM menu, press [F1] or [F2] (depending on the desired channel) at the user PROGRAM prompt.
- To enter the I/O submenu, press [F4] at the channel PROGRAM prompt.

1.6.4a Zero cutoff

- Enter the desired *zero cutoff* value and press the [ENT] key. A value of 0.1 ft/s (0.03 m/s) is recommended, but values from 0–1 ft/s (0–0.3 m/s) are acceptable.

1.6.4b Temperature input

NOTE:

This option appears only if you have selected *standard* as the equation type in the SYSTM submenu.

- At the *temperature input* prompt, press [F1] to enter a constant temperature value or press [Fx] to select the option card in slot x that will supply the live temperature input.

NOTE:

Each slot that contains an option card with an analog input assigned to TEMP or an RTD input will appear on the option bar. If the process temperature is stable, a fixed value may be used, but most applications require a live temperature input.

5. Do one of the following:

- If you selected FIXED, enter the known fixed process temperature. Press [ENT]. (The meter will accept values only from -148 ° to 662 °F.)
- If you selected SLOT X:
 - a. Press [F1] to select input A or press [F2] to select input B. The inputs were labeled during setup.

NOTE:

The set up of input A is used as an example. Identical procedures would be used to set up input B.

- b. Enter the *base temperature* (from -148 ° to 662°F), and press [ENT]. The ratio of this value to the actual temperature is used to calculate the standard volumetric flow.

1.6.4c Pressure input

6. At the *pressure input* prompt, press [F1] to enter a constant pressure value or press [Fx] to select the option card in slot X that will supply the live pressure input.

NOTE:

Each slot that contains an option card with an analog input assigned to PRESR will appear on the option bar. If the process pressure is stable, a fixed value may be used, but most applications require a live pressure input.

7. Do one of the following:

- If you selected FIXED, enter the known fixed process pressure. Press [ENT]. (The meter will only accept values from 0–5000 psia.)
- If you selected SLOT X:
 - a. Press [F1] to select input A or press [F2] to select input B. The inputs were labeled during setup.
 - b. Enter the *base pressure* (standard) value for the process, and press the [ENT] key. (The meter will only accept values from 0–5000 psia .)

IMPORTANT:

If an installed option card does not appear on the option bar for the TEMPERATURE INPUT or PRESSURE INPUT, the card may not have been initialized or it may be defective. Call the factory for assistance.

8. At the *N2 input* prompt, press [F1] to enter a constant nitrogen (N2) percentage or press [Fx] to select the option card in slot X that will supply the live N2 percentage.

9. Do one of the following:

- If you selected FIXED, enter the known fixed N2 value. Press [ENT]. (The meter accepts values from 0–100%.)
- If you selected SLOT X,
 - a. Press [F1] to select input A or press [F2] to select input B. The inputs were labeled during setup.

1.6.4d Procedure options

After completing the above steps, the meter returns to the channel PROGRAM prompt. Continue as follows:

- To continue programming the meter, refer to the menu maps in Appendix A and navigate to the desired menu. Then, proceed to the appropriate section of this manual for instructions.
- To leave the *user program* and retain the previous settings, press [EXIT] twice and then press [F1] = NO at the SAVE prompt. Any programming changes will be discarded and you will be returned to the data display.
- To leave the *user program* and return to measurement mode, press [EXIT] twice and then press [F2] = YES at the SAVE prompt. Your programming changes will be entered into the meter's memory, and you will be returned to the data display.

1.6.5 Entering setup data

The signal limits and response times for the model GF868 are specified via the SETUP submenu. It includes three submenus:

- **SIGNL** – set the parameters related to the transducer signal
- **AVRG** – specify the response of the meter to step changes
- **INIT** – initialize all parameters to default values.
- **ADVAN** – set up mass flow and enter a table of K factors

To enter the SETUP submenu, press [→] and [F1] at the channel PROGRAM prompt, and refer to figure 12.

Remember to record all programmed data in Appendix B, data records.

1.6.5a Setting signal limits

Use this option to set the limits for the incoming signal and other parameters affecting the transducer signal. For example, the programmed signal strength low limit may be used to determine the trigger point for an alarm.

Table 5 summarizes the default values and limits for parameters in this menu.



CAUTION!

The SIGNL default settings are suitable for most applications. Before changing any of these parameters, consult the factory.

Only after consultation with the factory, complete the following steps to enter the signal parameters:

1. Press [→] and [F1] = SIGNL to enter the SIGNAL submenu.
2. Press [ENT] to accept the current *signal low limit* value or enter a new value and press [ENT]. (The meter will only accept values from -20 to 100.)

The default value for this parameter is 20. The E1: LOW SIGNAL error message appears when the signal strength falls below the programmed SIGNAL LOW LIMIT value.

NOTE:

See the *service manual* for a discussion of error codes.

3. Press [ENT] to accept the current *cor. (correlation) peak limit* value or enter a new value and press [ENT]. The default value for this parameter is 100 and values from 0 to 500 are acceptable. The E4: SIGNAL QUALITY error message appears when the signal quality falls below the programmed COR. PEAK LIMIT value.
4. Press [ENT] to accept the current *velocity low limit* value or enter a new value and press [ENT].
The default value for this parameter is -300.0 ft/sec (-85 m/sec) and values from -500 to 500 ft/sec (-150 to 150 m/sec) are acceptable. The E3: VELOCITY RANGE error message appears when the calculated

fluid velocity is less than the programmed VELOCITY LOW LIMIT value.

5. Press [ENT] to accept the current *velocity high limit* value or enter a new value and press [ENT].

The default value for this parameter is 300.0 ft/sec (85 m/sec) and values from -500 to 500 ft/sec (-150 to 150 m/sec) are acceptable. The E3: VELOCITY RANGE error message appears when the calculated fluid velocity exceeds the programmed VELOCITY HIGH LIMIT value.

6. Press [ENT] to accept the current *acceleration* value or enter a new value and press [ENT].

The default value for this parameter is 100.0 ft/sec² (30.48 m/sec²) and values from 0 to 250 ft/sec² (0 to 76 m/sec²) are acceptable. The E6: CYCLE SKIP error message appears when the calculated fluid velocity changes by more than the programmed ACCELERATION LIMIT value from one reading to the next.

7. Press [ENT] to accept the current *amp. discrim low* value or enter a new value and press [ENT].

IMPORTANT:

Consult the factory before performing this step.

The amplitude discriminator measures the size of the transducer signal received by the model GF868. The default value for this parameter is 14 and values from 0 to 100 are acceptable. The E5: AMPLITUDE error message appears when the amplitude discriminator falls below the programmed AMP. DISCRIM LOW value.

8. Press [ENT] to accept the current *amp. discrim high* value or enter a new value and press [ENT].

The amplitude discriminator measures the size of the transducer signal received by the model GF868. The default value for this parameter is 34 and values from 0 to 100 are acceptable. The E5: AMPLITUDE error message appears when the amplitude discriminator exceeds the programmed AMP. DISCRIM HIGH value.

9. Press [ENT] to accept the current *delta T offset* value or enter a new value and press [ENT].

IMPORTANT:

Consult the factory before performing this step.

An offset between the upstream and downstream transit times is specified at this prompt. The default value for this parameter is 0 μsec and values from -1000 to 1000 μsec are acceptable.

10. Press [ENT] to accept the current *skan T offset* value or enter a new value and press [ENT].

At the above prompt, specify a time measurement offset that compensates for any shift resulting from cross-correlation. The default value for this parameter is 58 μsec and values from -500 to $500 \mu\text{sec}$ are acceptable.

NOTE:

If you enter a value of 0 for this command, you enable a special mode of operation, ACTIVE SKAN T-OFFSET, that dynamically calculates the offset.

11. Press [ENT] to accept the current *% of peak* value or enter a new value and press [ENT].

The percentage of peak used to calculate the transit times and delta T is specified at this prompt. The default value for this parameter is 50% and values from 1 to 100% are acceptable.

12. Use the [→] and [F1]-[F4] keys to select one of the preset values for the *XMIT sample size* from the option bar.

Both the upstream and downstream transducers transmit ultrasonic pulses in bursts, which consist of a series of transmit pulses. XMIT SAMPLE SIZE determines how many bursts are sent in one direction before sending in the other direction. The default value for this parameter is 8 and values of 2, 4, 8, 16 and 32 are acceptable.

13. Press [ENT] to accept the current *M>S_Switch* value or enter a new value and press [ENT].

If the burst mode is set to skan/measure (S/M), the meter switches from skan to measure mode when delta T is less than the M>S_switch value. **DO NOT** change this value unless advised to do so by the factory. The default value for this parameter is 50 μsec and values from 0 to 250 μsec are acceptable.

14. Press [ENT] to accept the current *# shifts* value or enter a new value and press [ENT].

The number of shifts corresponds to the actual number of transmits per cycle (number of signals added together in one direction to produce an averaged signal for one interrogation of the fluid) and need only be changed if the environment is very noisy or the acoustic signal is weak. The default value for this parameter is 3 and values from 0 to 10 are acceptable.

15. Press [ENT] to accept the current *a divisor* value or enter a new value and press [ENT].

A divisor is used in the calculation of the measure mode integrated threshold level and is not normally changed. The default value for this parameter is 2.5 and values from 0.1 to 10 are acceptable.

16. Press [ENT] to accept the current *# transmit pulses* value or enter a new value and press [ENT].

transmit pulses specifies the number of pulses in a burst. The default value for this parameter is 4 and values from 1 to 16 are acceptable. For difficult conditions (i.e., long paths, high velocity or high temperature), settings as high as 16 may be necessary.

17. Press [ENT] to accept the current *T window (cycles)* value or enter a new value and press [ENT].

Normally, the model GF868 calculates the size of the transmit window based on pipe size and fluid sound speed. However, for special diagnostic purposes, it may sometimes be necessary to reset the window size. The default value for this parameter is 0 and values from 0 to 1000 are acceptable.

18. Press [ENT] to accept the current *R window (cycles)* value or enter a new value and press [ENT].

Normally, the model GF868 calculates the size of the receive window based on pipe size and fluid sound speed. However, for special diagnostic purposes, it may sometimes be necessary to reset the window size. The default value for this parameter is 10 and values from 10 to 300 are acceptable.

NOTE:

If the T WINDOW prompt is set to 0, the R WINDOW prompt does not appear, and the GF868 uses a R WINDOW width based on the expected arrival of the signal.

After completing these steps, the program returns to the SETUP window.

Table 5: Default values and limits for SETUP Parameters

Parameter	Default value	Low limit	High limit
Signal low limit	20	-20	100
Cor. peak limit	100	0	500
Velocity low limit	-300.0 ft/sec (-85 m/sec)	-500 ft/sec (-150 m/sec)	+500 ft/sec (+150 m/sec)
Velocity high limit	300.0 ft/sec (85 m/sec)	-500 ft/sec (-150 m/sec)	+500 ft/sec (+150 m/sec)
Acceleration limit	100.0 ft/sec ² (30.48 m/sec ²)	0	250 ft/sec ² (76 m/sec ²)
Amp. discrim low	14	0	100
Amp. discrim high	34	0	100
Delta T offset	0	-1,000 µsec	1,000 µsec
Skat T offset	58 µsec	-500 µsec	500 µsec
% of peak	50%	1%	100%
XMIT sample size	8	2	32
M>S switch	50 µsec	0 µsec	250 µsec
# shifts	3	0	10
A divisor	2.5	0.1	10
# transmit Ppulses	4	1	16
T window	0	0	1,000
R window	10	10	300

1.6.5b Setting response time

Use this option to specify the number of readings that occur before the meter will respond to a step change in flow rate. In general, the smaller the number of readings, the less steady the display will appear.

1. Press [→] and [F2] = AVRG to enter the AVERAGE submenu.
2. Use the [→] and [F1]-[F4] keys to select the desired option. The available response time options are 1, 2, 5, 10, 30, 60 readings and STATS. For best results, select STATS (statistics), as this increases the response time under steady flow conditions while still allowing a rapid response to changes in flow rate.

After completing this step, the program returns to the SETUP window.

1.6.5c Initializing the system

Use this option to initialize (reset) many of the parameters within the SETUP menu to their default values. These parameters include: signal low limit, correlation peak limit, velocity low and high limits, Acceleration limit, Amplitude discrimination low, Amplitude discrimination high, Delta T offset, skat T offset, % of peak and XMIT sample size. They do **not** include: M>S_Switch, # Shifts, A divisor, # transmit Pulses, T WINDOW and R WINDOW, which remain at their last programmed values.

1. Press [→] and [F3] = INIT.
2. Press [F1] = NO to keep the current values or press [F2] = YES to reset all values to their default settings.

1.6.5d Setting advanced parameters

The ADVAN option enables you to access the more advanced features of the GF868. In this option you can perform two functions:

- enable mass flow (calculated for static fluid density)
- enter a table of K-factors (based on velocity or Reynolds number) that compensates for non-linear flow rates (see Editing K factors below)

To enter the ADVAN submenu, press [F4] at the SETUP window.

Entering mass flow

1. Press [F1] = MASS to enter the mass flow option.
2. At the *static density?* prompt, press [F1] = NO or [F2] = YES. If you press NO, the GF868 returns to the advanced features prompt.
3. If you press YES, enter the *fluid density* of the gas to be measured and press [ENT]. (The meter will only accept values from 0.00001-100 lb/ft³.)

The GF868 returns to the advanced features prompt.

Editing K factors

1. Press [F2] = MULTK to enter the MultiK option.
2. Press [F1] = NO to disable or [F2] = YES to enable multiple K-factors.
 - If you press NO, the GF868 returns to the advanced features prompt.
 - If you press YES, complete the steps below.
 - a. The GF868 asks for the type of K factor. Press [F1] to select CstV (custom velocity) or [F2] to select CstR (custom Reynolds number).
 - If you enable CstR, you must also enter the kinematic viscosity of your gas, as listed in *sound speeds and pipe size data*. Use the numeric keys to enter a value, and press [ENT].
 - b. Press [F1] = NO to retain the current K-factor table and return to the advanced features prompt, or press [F2] = YES to edit The K-factor table.

NOTE:

If velocity vs. K-factor data was not provided with the model GF868, the K-factor table can not be edited.

- c. Enter the *number of K-factors* to be entered into the table. Press [ENT]. (The meter will only accept values from 2 to 20.)

IMPORTANT:

When editing the K-factor table, the velocities must be entered in increasing order.

- d. Enter the *velocity value* for K-factor number "x". Press [ENT]. (The meter will only accept values from - 30,000 to +30,000 ft/sec.)
 - e. Enter the *K-factor* corresponding to velocity number "x". Press [ENT].
3. Repeat steps c and d until all of the data points have been entered.
 4. The GF868 returns to the advanced features prompt.

1.6.5e NHV programming

Enable NHV (net heating value)

The GF868 can be equipped with an additional feature that calculates the Net heating valve (NHV) of the gas mixture based on its molecular weight.

If you purchased the optional NHV feature, the following prompts will be available.

1. Press [F3] = NHV to enter the NHV option.
2. Press [F1] = NO to disable or [F2] = YES to enable *NHV calculations*.
 - If you press NO, the GF868 returns to the advanced features prompt.
 - If you press YES, complete the steps below.
 - a. The GF868 asks for the NHV units. Press [F1] to select BTU (BTU/SCF), [F2] to select MJ/m³ (mega Joules per cubic meter), or [F3] to select KJ/m³ (Kilo Joules per cubic meter).
3. Press [F1] = NO to disable, or press [F2] = YES to *enable H₂ compensation*.
 - If you press NO, the GF868 returns to the advanced features prompt.
 - If you press YES, complete the steps below.
 - a. At the H₂ input prompt, press [F1] to enter a constant hydrogen (H₂) percentage or press [Fx] to select the option card on slot X that will supply the live H₂ percentage.
 - b. Do one of the following:
 - If you selected FIXED, enter the known fixed H₂ value. Press [ENT]. (The meter accepts values from 0-100%)
 - If you select slot X. Press [F1] to select input A or press [F2] to select input B. The inputs were labeled during setup.

1.6.5 f Procedure options

After completing the above steps, the meter returns to the ADVANCED FEATURES prompt. Continue as follows:

- To continue programming the meter, refer to the menu maps in Appendix A and navigate to the desired menu. Then, proceed to the appropriate section of this manual for instructions.
- To leave the *user program* and retain the previous settings, press [EXIT] twice and then press [F1] = NO at the SAVE prompt. Any programming changes will be discarded and you will be returned to the data display.
- To leave the *user program* and return to measurement mode, press [EXIT] twice and then press [F2] = YES at the SAVE prompt. Your programming changes will be entered into the meter's memory, and you will be returned to the data display.

1.7 Entering global data

The GLOBL menu is used to enter information that is not specific to one of the individual channels. Information programmed via this menu is used to compute parameters such as the sum, difference or average of the channel 1 and channel 2 signals. In addition, several general system parameters may be entered in the GLOBL menu.

IMPORTANT:

When calculating the SUM, DIF or AVE readouts, data from the GLOBL-SYSTEM submenu is used.

Any conflicting data entered in the CH1-SYSTEM or CH2-SYSTEM submenus is overridden.

The following submenus are included in the GLOBL menu:

- **CLOCK** - used to enter the current date and time
- **SYSTEM** - used to specify the units of measure used in calculations
- **I/O** - used to set up error handling and to configure analog inputs and outputs
- **COMM** - used to set up the serial communications port
- **SECUR** - used to specify a programming access password.

After selecting [F3]=GLOBL at the initial programming screen, the following screen appears:

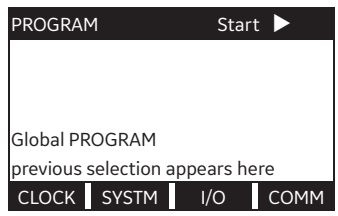

PROGRAM Start ▶

Global PROGRAM
previous selection appears here

CLOCK | SYSTEM | I/O | COMM

Use the [←] and [→] keys and [F1]-[F4] function keys to select the desired submenu. Complete the steps listed to program each submenu.

Refer to figure 13 and figure 14, and remember to record all programming data in Appendix B, *data records*.

1.7.1 Setting the clock

Use the CLOCK submenu to enter the current date and time. Refer to figure 13. To program the CLOCK submenu, press [F1] at the Global PROGRAM prompt and complete the following steps:

1.7.1a Setting the date

1. The first prompt displays the programmed *date*.
 - If the displayed date is correct, press [F1] = OK and proceed to step 2.
 - If the displayed date is incorrect, press [F2] = EDIT to change the date, and complete the steps below.
 - a. Enter the current year and press [ENT]. The allowable range is 0 to 99.
 - b. Use the [←], [→] and [F1]-[F4] keys to select the current month.
 - c. Enter the current day and press [ENT]. The allowable range is 1 to the number of days in the current month.

1.7.1b Setting the time

2. The next prompt displays the programmed *time*.
 - If the displayed time is correct, press [F1] = OK to return to the GLOBL prompt.
 - If the displayed time is incorrect, press [F2] = EDIT to change the time, and complete the steps below.
 - a. Press [F1] = AM or [F2] = PM. Then enter the current hour and press [ENT]. The allowable range is 1 to 12.

NOTE:

A time of 12 PM represents noon and a time of 12 AM represents Midnight.

- b. Enter the current *minutes* and press [ENT]. The allowable range is 0 to 59.
- c. Enter the current *seconds* and press [ENT]. The allowable range is 0 to 59. After completing the above steps, the program returns to the GLOBL window.

1.7.2 Entering global system data

Refer to figure 13. To program this submenu, press [F2] at the global PROGRAM prompt, and complete the following steps:

1. At the *system units* prompt, press [F1] = ENG to display parameters and measurements in English units or [F2] = METRC to display parameters and measurements in metric units.
2. Use the [F1]-[F4] keys to select the desired type of *pressure units* for display, as shown in table 6.

Table 6: Available Pressure units

English	Metric
PSIa = pounds per square inch absolute	BARa = bar absolute
PSIg = pounds per square inch gauge	BARg = bar gauge
kPaa = kiloPascals absolute	
kPag = kiloPascals gauge	

NOTE:

The choices shown on the option bar are determined by the selections made at the previous SYSTEM UNITS prompt.

- If you have entered gauge pressure, or the local atmospheric pressure (PSIg, BARg or kPag), the GF868 asks for a *gauge pressure* value. Enter the value, and press [ENT].
3. At the *stopwatch totalizer* prompt, press [F1] = AUTO to measure totals automatically or press [F2] = MNU-AL to measure totals manually with the stopwatch timer.

If AUTO is selected above, the meter automatically begins totalizing upon leaving the *user program*. If MNUAL is selected, the console key on the keypad may then be used to start and stop the totalizer. The manner in which the stopwatch totalizer responds to an error condition may be set in the I/O submenu.

IMPORTANT:

After setting up the stopwatch totalizer, press [CLR] to clear the stopwatch totalizer, or the new totals will be added to any previously accumulated totals.

NOTE:

The manner in which the stopwatch totalizer responds to an error condition may be set in the I/O submenu.

1.7.2a Entering volumetric data

4. Use the [F1]-[F4] and [→] keys to select the desired *volumetric units* for the flow rate display. (See figure 13 for all available volumetric and totalizer units.)
5. Use the [F1]-[F4] and [→] keys to select the desired *volumetric time* units for the display.
6. Use the [F1]-[F4] keys to select the desired number of *vol decimal digits* to the right of the decimal point in the display.
7. Use the [F1]-[F4] and [→] keys to select the desired *totalizer units*.
8. Use the [F1]-[F4] keys to select the desired number of *total decimal digits* to the right of the decimal point in the display.

1.7.2b Entering mass flow data

9. Use the [F1]-[F4] and [→] keys to select the desired *mass flow* units for the flow rate display. (See figure 13 for all available mass flow units.)
10. Use the [F1]-[F4] keys to select the desired *mass flow time* units for the display.
11. Use the [F1]-[F4] keys to select the desired number of *MDOT decimal digits* in the mass flow rate display.
12. Use the [F1]-[F4] keys to select the desired units for the *mass totalizer*.
13. Use the [F1]-[F4] keys to select the number of *mass decimal digits* in the totalized mass flow display. After completing the above steps, the program returns to the GLOBL window.

1.7.2c Procedure options

After completing the above steps, the meter returns to the GLOBL window. Continue as follows:

- To continue programming the meter, refer to the menu maps in Appendix A and navigate to the desired menu. Then, proceed to the appropriate section of this manual for instructions.
- To leave the *user program* and retain the previous settings, press [EXIT] twice and then press [F1] = NO at the SAVE prompt. Any programming changes will be discarded and you will be returned to the data display.
- To leave the *user program* and return to measurement mode, press [EXIT] twice and then press [F2] = YES at the SAVE prompt. Your programming changes will be entered into the meter's memory, and you will be returned to the data display.

NOTE:

See the SAVE submenu section for more information on this function.

1.7.3 Setting up global inputs/outputs

The I/O submenu allows users to program error handling responses, as well as both built-in and optional analog outputs and cards. To program this submenu, press [F3] at the global PROGRAM prompt, and refer to figure 14.

- Press [F1] to set up error handling, or
- Press [F2] to set up any in-puts or outputs. Complete the steps below to program each submenu.

NOTE:

Be sure to record all programmed data in Appendix B, *data records*.

1.7.3a Selecting error handling

This menu option permits programming of the manner in which the model GF868's totalizers respond during an error condition. See chapter 2, *error codes and screen messages*, of the *service manual* for a discussion of the built-in error codes.

1. At the I/O prompt, press [F1] (error).
2. Press [F1] if you want the GF868 to *hold* the last "good" reading and continue to totalize, based on that reading, or press [F2], *no up*, if you want the meter to stop totalizing.
3. Press [F1] = NO to disable 2-path error handling, or press [F2] = YES to enable 2-path error handling.

For the AVE mode, the 2-path error handling option is intended for applications where two sets of transducers are installed in the same location in the same pipe to improve accuracy. With this function enabled, the model GF868 performs error handling only if both channels are in error. If this function is disabled, error handling occurs when either channel goes into error. Specific responses of the display and the totalizer to the 2-path error handling option are listed in table 7.

Table 7: 2-Path error response options

Option	Totalizer response
NO	Outputs the average of CH1 and CH2 totals, regardless of the error state of either channel.
YES	<ol style="list-style-type: none"> 1. If one channel is in error, totalizing continues. 2. If both channels are in error, totalizing stops.

1.7.3b Self-Calibration Option

4. Press [F1] = NO to disable CAL?, or press [F2] = YES to enable CAL?.
5. If you enabled self-calibration in the previous step, press [F1] = SPAN to use the Span method or [F2] = RANGE to use the Range method.

Span Method

6. Enter the VELOCITY FULL SPAN value. This is the maximum operational velocity for your application, and the default value is 275 ft/sec. Press [ENT].
7. Use the [←] and [→] to select the desired SPAN LOW % value from the available options, and press [ENT]. The default value is 20%.
8. Use the [←] and [→] to select the desired SPAN HIGH % value from the available options, and press [ENT]. The default value is 80%.
9. Input the HOUR (1-12) at which you want the self-calibration to run each day. Then press [F1] to select AM or [F2] to select PM.

Range Method

6. Enter the CAL Velocity 1 value. This is the low-end velocity for the lower range calibration. Press [ENT].
7. Enter the CAL Velocity 2 value. This is the high-end velocity for the lower range calibration. Press [ENT].
8. Enter the CAL Velocity 3 value. This is the low-end velocity for the higher range calibration. Press [ENT].
9. Enter the CAL Velocity 4 value. This is the high-end velocity for the higher range calibration. Press [ENT].
10. Input the HOUR (1-12) at which you want the self-calibration to run each day. Then press [F1] to select AM or [F2] to select PM.

The *User Program* automatically returns to the Global I/O prompt after the step above is completed.

1.7.3c Setting up option cards

The model GF868 has two built-in analog outputs, which are assigned to slot 0. Also, a variety of option cards may be installed in the six expansion slots. See chapter 1, *installation*, of the *startup guide* for a complete description of the available option cards.

NOTE:

For this discussion, *slot x* will be used to reference any of the specific expansion slots (slot 1 – slot 6). If the number of a slot with an installed option card does not appear, the card may not have been initialized or it may be defective. Call the factory for assistance.

- Use the [←] and [→] and the [F1]-[F4] keys to select the desired slot number. (Only those slots which contain an option card will appear on the option bar.)

Refer to the menu map in figure 14 in Appendix A, *menu maps*, and complete the following steps to setup and/or scale the model GF868's analog inputs and outputs.

Slot X analog outputs

1. Use the [F1]-[F2] keys to set up outputs A or B respectively.

NOTE:

The set up of output A is used as an example. Identical procedures would be used to set up output B.

2. Press [F1] = OFF to disable output A and return to the previous prompt, or press [F2] = 0-20 m or [F3] = 4-20 m to specify the desired range for output A.
3. Use the [←] and [→] and [F1]-[F4] keys to select a *channel* option for the data source.
4. Use the [←] and [→] and [F1]-[F4] keys to specify the desired *output measurement* parameter.
5. Enter the *zero* value for the low end of the chosen output range. Press [ENT].
6. Enter the *full* value for the high end of the chosen output range. Press [ENT].
7. Press [F1]-[F4] to set up another output or press [EXIT] to select another slot for set up.

Alarms

1. Use the [F1]-[F3] keys to set up alarm relays A, B, or C, respectively.

NOTE:

The set up of alarm A is used as an example. Identical procedures would be used to set up the other alarms.

2. Press [F1] = OFF to disable alarm A and return to the previous prompt, or press [F2] = HIGH, [F3] = LOW or [F4] = FAULT to specify the type for Alarm A.
3. Press [F1] = NO for standard operation or [F2] = YES for failsafe operation.
4. Use the [←] and [→] and [F1]-[F4] keys to select a channel option for the data source.
5. The prompts now vary with your choice in step 2.
 - If you selected FAULT, proceed to step 6.
 - If you selected HIGH or LOW, complete the steps below.
 - a. Use the [←] and [→] and [F1]-[F4] keys to specify the desired output measurement parameter.
 - b. Enter a value for the trigger point of the alarm and press [ENT].
6. Press [F1]-[F3] to set up another alarm or press [EXIT] to select another slot for set up.

1.7.3d Totalizer/frequency outputs

1. Press [F1]-[F4] to set up outputs A, B, C or D, respectively.
2. Press [F1] = OFF to disable output A and return to the previous prompt, or press [F2] = FREQ or [F3] = TTLZR to designate output A as a frequency or a totalizer output, respectively.

NOTE:

The setup of output A is used as an example. Identical procedures would be used to set up the other outputs.

3. Use the [←] and [→] and [F1]-[F4] keys to select a channel option for the data source.
 - To program a frequency output, go to step 4.
 - To program a totalizer output, go to step 5.

Frequency output

1. The FREQ output, [F2], produces a frequency pulse that is proportional to the output measurement. Complete the steps below to program the frequency output.
 - a. Use the [←] and [→] and [F1]-[F4] keys to specify the desired output measurement parameter.
 - b. Enter the *base* value for the low end of the frequency output range and press [ENT].
 - c. Enter the *full* value for the high end of the frequency output range. Press [ENT].
 - d. Enter a value between 1 and 10,000 for the *full scale frequency*. Press [ENT].

Totalizer output

1. The TTLZR output, [F3], issues one pulse per selected volume of flow. The meter produces a pulse each time the programmed amount of flow passes through the pipe. Complete the steps below to program the totalizer output.
 - a. Press [F1] = +TOTL to totalize the forward flow, [F2] = -TOTL to totalize the reverse flow, [F3] = +MASS (if available) to totalize the forward mass flow or [F4] = -MASS (if available) to totalize reverse mass flow.
 - b. Enter a value from 50 to 500,000 μ sec for the *minimum pulse ON* time and press [ENT].

NOTE:

A complete pulse consists of equal amounts of ON and OFF times. Choose a value that is compatible with the frequency counter to be used.

- c. Enter a value for the number of measurement *units/pulse* and press [ENT].
2. Press [F1]-[F4] to set up another totalizer/frequency output or press [EXIT] to select another slot for setup.

Analog inputs

1. Press [F1] to set up input A or [F2] to set up input B.

NOTE:

The set up of input A is used as an example in this manual. Identical procedures would be used to set up input B. (An analog input option card may contain one standard analog input and one RTD analog input.)

2. Enter a *label* of up to eight characters for input A and press [ENT].
3. At the *input measurement* prompt, press [F1] = OFF to disable input A and return to the previous prompt, or press [F2] = PRESR (pressure), [F3] = TEMP (temperature) or [F4] = SPEC (special) to designate the input.
4. Do one of the following:
 - If you selected PRESR or TEMP, proceed to step 5.
 - If you selected SPEC, complete the steps below.
 - a. Enter an *input name* and press [ENT].
 - b. Enter the *input units* of measurement and press [ENT].
5. Enter the *zero value* for the low end of the chosen input range and press [ENT].
6. Enter the *full scale value* for the high end of the chosen input range and press [ENT].
7. Press [F1]-[F2] to set up another input or press [EXIT] to select another slot for setup.

Option card RTD inputs

Option cards with RTD inputs have a temperature range of -100 ° to 350 °C. Complete the following steps to set up the two RTD inputs of an option card installed in slot x:

1. Press [F1] to set up RTD input A or [F2] to set up RTD input B.

NOTE:

The setup of RTD input A is used as an example. Identical procedures would be used to set up RTD input B.

2. Enter a label of up to eight characters and press [ENT].
3. At the *input measurement* prompt, press [F1] = OFF to disable RTD input A and return to the previous prompt, or press [F2] = TEMP to enable RTD input A.
4. Enter the *zero value* for the low end of the chosen input range and press [ENT].
5. Enter the *full scale value* for the high end of the chosen input range and press [ENT].
6. Press [F1]-[F2] to set up another input or press [EXIT] to select another slot for set up.

For instructions on setting up additional inputs and/or outputs, proceed to the appropriate section. Otherwise, press [EXIT] twice to return to the Global PROGRAM prompt.

Procedure options

After completing the above steps, the meter returns to the global I/O prompt. Continue as follows:

- To continue programming the meter, refer to the menu maps in Appendix A and navigate to the desired menu. Then, proceed to the appropriate section of this manual for instructions.
- To leave the *user program* and retain the previous settings, press [EXIT] twice and then press [F1] = NO at the SAVE prompt. Any programming changes will be discarded and you will be returned to the data display.
- To leave the *user program* and return to measurement mode, press [EXIT] twice and then press [F2] = YES at the SAVE prompt. Your programming changes will be entered into the meter's memory, and you will be returned to the data display.

NOTE:

See the SAVE submenu section for more information on this function.

1.7.4 Setting up communications

The model GF868 flowmeter can transmit stored data and displayed readings to a remote ANSI terminal or a personal computer by connecting the meter's RS232 interface to the serial port of the PC. In addition, the model GF868 can receive and execute remote commands via this link. The meter can also be configured with a MODBUS option card for MODBUS (RS485) communications, a foundation fieldbus option card for foundation fieldbus communications or with a MODBUS/TCP option card for MODBUS communications over the Ethernet, if desired.

NOTE:

To set fieldbus communications parameters, see Appendix D, *foundation fieldbus communications*.

Use the COMM submenu to set the RS232, MODBUS, Ethernet and MODBUS/TCP communications port parameters and to enter a network identification number. A network identification number is required to use the Panametrics *instrument data manager* or *PanaView* software. To program the COMM submenu, press [F4] at the initial Global PROGRAM screen and complete the following steps. Refer to the menu map in figure 13.

1. Use the [←] and [→] and [F1]-[F4] keys to select the desired *baud rate*. The available rates are 300, 600, 1200, 2400, 4800, 9600 and 19,200 baud.
2. Use the [←] and [→] and [F1]-[F4] keys to select the number of *UART bits*.
3. Enter a *network ID* number between 1 and 254 and press [ENT]. The default number is 1.

A network ID number is only necessary for communication with the Panametrics *Instrument Data Manager™* or *PanaView™* software. See the software user's manual for more information.

IMPORTANT:

If the network ID number is changed, communication with the instrument data manager or PanaView must be reestablished with the new ID number.

1.7.4a MODBUS (RS485) parameters

If your GF868 does not include an option card for MODBUS communications, you have completed programming the COMM submenu. However, if you have installed a MODBUS option card, the following additional prompts appear.

1. Press [F1]-[F4] to select the desired MODBUS baud rate from four selections: 2400, 4800, 9600 and 19,200.
2. Press [F1]-[F3] to set the MODBUS parity as none, odd or even.
3. Press [F1] to select one MODBUS stop bit, or [F2] to select two stop bits.
4. Use the numeric keys to enter a MODBUS address (from 1 to 247) and press [ENT].

1.7.4b MODBUS/TCP parameters

If your GF868 does not include an option card for MODBUS/TCP communications, you have completed programming the COMM submenu. However, if you have installed a MODBUS/TCP option card, complete the following steps:

1. Press [F3] to select the appropriate *MODBUS baud rate* of 9600.
2. Press [F1]-[F3] to set the *MODBUS parity* as none, odd or even.
3. Press [F1] to select one *MODBUS stop bit*, or [F2] to select two stop bits.
4. Use the numeric keys to enter a *MODBUS address* (from 1 to 247) and press [ENT].

1.7.4c Procedure options

After completing the above steps, the meter returns to the global PROGRAM prompt. Continue as follows:

- To continue programming the meter, refer to the menu maps in Appendix A and navigate to the desired menu. Then, proceed to the appropriate section of this manual for instructions.
- To leave the *user program* and retain the previous settings, press [EXIT] twice and then press [F1] = NO at the SAVE prompt. Any programming changes will be discarded and you will be returned to the data display.
- To leave the *user program* and return to measurement mode, press [EXIT] twice and then press [F2] = YES at the SAVE prompt. Your programming changes will be entered into the meter's memory, and you will be returned to the data display.

NOTE:

See the SAVE submenu section for more information on this function.

1.7.5 MODBUS register map

When equipped with the optional MODBUS output card, the GF868 flow transmitter can send flow data and diagnostic information to a flow computer (or SCADA) serially, using a Gould-type RTU protocol. In this case, only the MODBUS function command, 3 (read multiple registers), 6 (write multiple registers) is valid. The format for the data exchange is as follows:

- The **send** command (initiated by the host flow computer or controller) comes in the form:
[time delimiter]<Addr><3><first register MSB>
<First register LSB><register count MSB>
<Register count LSB><CRC low><CRC high>[time delimiter]
- The response (initiated by the host flow computer or controller) comes in the form:
[time delimiter]<Addr><3><byte count><data.....>
<CRC low><CRC high>[time delimiter]

The format for the returned data types is as follows:

- Integer (16 bit integer) <MSB><LSB>
1 register - 16 bit integer
- Integer (32 bit integer) <MSB><LSB><LSB><LSB>
2 register - 32 bit integer
- Floating point (FP) <EXP><MAN><MAN><MAN>
2 registers - 32 bit IEEE floating point number

To request specific parameters from the GF868 via the MODBUS, the control system must enter the appropriate register number. Only registers 1 through 90 are available for MODBUS communications, while registers 508 through 512 are used by the GF868 to store the MODBUS parameters. For details, see table 8.

Table 8: MODBUS registers for a 2-channel GF868

MODBUS reg #	DPR hex addr	Description	Scaling (decimal places)	Size in bytes
1	0	1" Clear ch1 totalizers"	--	2 (16 bit signed)
2	2	1" Clear ch2 totalizers"	--	2 (16 bit signed)
3	4	Ch1 velocity	2	4 (2 16-bit int)
5	8	Ch1 Act volumetric	#Q DIGITS	4 (IEEE 32 bit)
7	C	Ch1 std volumetric	#Q DIGITS	4 (IEEE 32 bit)
9	10	Ch1 fwd totals	#T DIGITS	4 (2 16 bit int)
11	14	Ch1 rev totals	#T DIGITS	4 (2 16 bit int)
13	18	Ch1 #tot digits	0	2
14	1A	Ch1 mass flow	#M DIGITS	4 (IEEE 32 bit)
16	1E	Ch1 fwd mass totals	#MT DIGITS	4 (2 16-bit int)
18	22	Ch1 rev mass totals	#MT DIGITS	4 (2 16-bit int)
20	26	Ch1 #mass tot digits	0	2
21	28	Ch1 timer	2	4 (2 16-bit int)
23	2C	Ch1 error code	0	2
24	2E	Ch1 sound speed	3	4 (2 16-bit int)
26	32	Ch1 molecular weight	4	4 (2 16-bit int)

Table 8: MODBUS registers for a 2-channel GF868

MODBUS reg #	DPR hex addr	Description	Scaling (decimal places)	Size in bytes
28	36	Ch1 sig strength upstream	1	4 (2 16-bit int)
30	3A	Ch1 sig strength downstream	1	4 (2 16-bit int)
32	3E	Ch1 temperature	2	4 (2 16-bit int)
34	42	Ch1 pressure	3	4 (2 16-bit int)
36	46	Ch2 velocity	2	4 (2 16-bit int)
38	4A	Ch2 act volumetric	#Q DIGITS	4 (IEEE 32 bit)
40	4E	Ch2 std volumetric	#Q DIGITS	4 (IEEE 32 bit)
42	52	Ch2 fwd totals	#T DIGITS	4 (2 16 bit int)
44	56	Ch2 rev totals	#T DIGITS	4 (2 16 bit int)
46	5A	Ch2 #tot digits	0	2
47	5C	Ch2 mass flow	#M DIGITS	4 (IEEE 32 bit)
49	60	Ch2 Fwd mass totals	#MT DIGITS	4 (2 16-bit int)
51	64	Ch2 rev mass totals	#MT DIGITS	4 (2 16-bit int)
53	68	Ch2 #mass tot digits	0	2
54	6A	Ch2 timer	2	4 (2 16-bit int)
56	6E	Ch2 error code	0	2
57	70	Ch2 sound speed	3	4 (2 16-bit int)
59	74	Ch2 molecular weight	4	4 (2 16-bit int)
61	78	Ch2 sig strength upstream	1	4 (2 16-bit int)
63	7C	Ch2 sig strength downstream	1	4 (2 16-bit int)
65	80	Ch2 temperature	2	4 (2 16-bit int)
67	84	Ch2 pressure	3	4 (2 16-bit int)
69	88	Avg velocity	2	4 (2 16-bit int)
71	8C	Avg act volumetric	#Q DIGITS	4 (IEEE 32 bit)
73	90	Avg std volumetric	#Q DIGITS	4 (IEEE 32 bit)

Table 8: MODBUS registers for a 2-channel GF868

MODBUS reg #	DPR hex addr	Description	Scaling (decimal places)	Size in bytes
75	94	Avg fwd totals	#T DIGITS	4 (2 16 bit int)
77	98	Avg rev totals	#T DIGITS	4 (2 16 bit int)
79	9C	Avg #tot digits	0	2
80	9E	Avg mass flow	#M DIGITS	4 (IEEE 32 bit)
82	A2	Avg fwd mass totals	#MT DIGITS	4 (2 16-bit int)
84	A6	Avg rev mass totals	#MT DIGITS	4 (2 16-bit int)
86	AA	Avg #mass tot digits	0	2
87	AC	Avg timer	2	4 (2 16-bit int)
89	B0	⁵ Avg error code	0	2
90	B2	Avg sound speed	3	4 (2 16-bit int)
480	3BE	CalDate as YYYYMMDD	0	4 (2 16-bit int)
482	3C2	CalTime as HHMM	0	4 (2 16-bit int)
484	3C6	Ch1 Zero or Range1 Zero Pct	2	4 (2 16-bit int)
486	3CA	Ch1 Full or Range1 Full Pct	2	4 (2 16-bit int)
488	3CE	Ch1 Range2 Zero Pct (if appl)	2	4 (2 16-bit int)
490	3D2	Ch1 Range2 Full Pct (if appl)	2	4 (2 16-bit int)
492	3D6	Ch1 Zero or Range1 Zero Pct	2	4 (2 16-bit int)
494	3DA	Ch2 Full or Range1 Full Pct	2	4 (2 16-bit int)
496	3DE	Ch2 Range2 Zero Pct (if appl)	2	4 (2 16-bit int)
498	3E2	Ch2 Range2 Full Pct (if appl)	2	4 (2 16-bit int)
508	3F6	² MODBUS baud rate	0	2
509	3F8	³ MODBUS parity	0	2
510	3FA	⁴ MODBUS stop bits	0	2
511	3FC	MODBUS meter addr	0	2
512	3FE	RESERVED	---	---

Notes:

1. Clear totalizers: flag from the 8051 to clear either the channel 1 or channel 2 totalizers.
2. MODBUS baud rate: 5 = 2400, 6 = 4800, 7 = 9600, 8=19200
3. MODBUS parity: 0 = none, 1 = odd, 2 = even
4. MODBUS stop bits: 1 = 1 stop bit, 2 = 2 stop bits
5. AVG error code: 0=both ch1 and ch2 are in error. 1=ch1 only is in error
2=ch2 only is in error
3=Both channels are error free
6. You must scale measurements in the host system. For example, velocity scaling is two decimal places; thus, if the MODBUS card reports that the velocity is 100, the host system must interpret the number as 1.00 (two decimal places)

1.7.6 Activating security

In order to prevent unauthorized tampering with the flowmeter's programming, the model GF868 is equipped with a security feature that locks out the following menus:

- Program menu [PROG]
- Calibration menu [CAL]
- Log menu [LOG]
- Clear menu [CLR]

When the system is locked, access to the above menus will be denied unless the correct password is entered. The model GF868 is shipped with a *default password*, which is given later in this section. For increased security, the default password should be changed.

IMPORTANT:

Once the system has been locked, it can only be unlocked by entering the password, because access to the SECUR submenu is restricted.

To program the SECUR submenu, press [→] and [F1] at the Global PROGRAM prompt. Refer to figure 13.

IMPORTANT:

It is recommended that all program parameters be recorded **before** changing the password. (This information should be recorded in Appendix B, data records, as a matter of routine.) If the password is lost, the site data is **not** retrievable and will have to be reentered.

1. At the *lock out* prompt, press [F1] = UNICK to unlock the system and return to the Global PROGRAM prompt, or press [F2] = LOCK to lock the system.

NOTE:

If the system was unlocked at the above prompt, the following three prompts do not appear.

2. Enter the current *password* (**2719** is the default password) and press [ENT].
3. At the *?edit password* prompt, press [F1] = NO to leave the password unchanged and return to the Global PROGRAM prompt, or press [F2] = YES to enter a new password.

IMPORTANT:

Since the default password is printed in this manual, a new password should be entered. If the password is ever lost, contact the factory for assistance.

4. Enter the *new password* and press [ENT]. Any combination of letters and numbers up to a total of 21 characters may be used as a password.

NOTE:

Keep in mind that the password may have to be entered frequently from the keypad. A long and/or complex password may soon become annoying to use.

5. *Verify the new password* by entering it again and press [ENT]. Be sure to record the new password in a safe place.

1.7.6a Procedure options

After completing the above steps, the meter returns to the Global PROGRAM prompt. Continue as follows:

- To continue programming the meter, refer to the menu maps in Appendix A and navigate to the desired menu. Then, proceed to the appropriate section of this manual for instructions.
- To leave the *user program* and retain the previous settings, press [EXIT] twice and then press [F1] = NO at the SAVE prompt. Any programming changes will be discarded and you will be returned to the data display.
- To leave the *user program* and return to measurement mode, press [EXIT] twice and then press [F2] = YES at the SAVE prompt. Your programming changes will be entered into the meter's memory, and you will be returned to the data display.

NOTE:

See the SAVE submenu section for more information on this function.

1.8 Saving site files

The currently programmed site data may be stored in the model GF868's nonvolatile memory by saving it as a site file. Up to ten site file names, consisting of up to five characters each, may be stored at any given time. To enter the SAVE menu, press [F4] at the initial *user program* screen. Refer to figure 13.

1. Enter a new site file name and press [ENT], or use the [←], [→] and [F1]-[F4] keys to select and overwrite an existing site file.

NOTE:

The option bar will show only as many choices as there are existing site files.

If ten site files are already stored in memory, an existing site file must be deleted before a new site file name can be assigned. See chapter 5, *clearing data*, for details.

When a site file is stored in memory, it becomes the active site file until another site file is created or retrieved. (See the next section for instructions on retrieving a site file.) To verify that the site file has been saved, use the [←] key to scroll back to the SITE NAME prompt and see if the name appears on the option bar (use the [←] and [→] keys to scroll through the list, if necessary). Whenever a new site file name is saved, it is automatically assigned to the next available function key.

IMPORTANT:

The CLOCK and I/O data is **not** saved with the site file, while the SYSTM and COMM data **is** saved with the site file.

2. Use the [←] and [→] and [F1]-[F4] keys to select another menu, or press [EXIT] to leave the *user program* and return to measurement mode.

1.9 Recalling site files

Any site file currently stored in the model GF868's nonvolatile memory may be recalled at any time. Up to ten site file names, consisting of up to five characters each, may be stored at any given time. To enter the RECALL menu, press [→] and [F1] at the initial *user program* screen.

1. Use the [←] [→] and [F1]-[F4] keys to select and recall an existing site file.

NOTE:

The option bar shows only as many choices as there are existing site files. The files are listed in chronological order by creation date.

Upon recall, the selected site file becomes active and all of its programmed parameters become current.

IMPORTANT:

The CLOCK and I/O data is **not** recalled with the site file, while the SYSTM and COMM data **is** recalled with the site file.

NOTE:

If you have loaded a site file into a GF868, but the option cards are not in the same slots or programmed the same way as when the site file was first saved, the GF868 displays a warning to review slot information. This display does not mean that the option cards have lost their program information!

2. Use the [←] and [→] and [F1]-[F4] keys to select another menu, or press [EXIT] to leave the *user program* and return to measurement mode.

[no content intended for this page]

Chapter 2. Displaying data

2.1 Introduction

This chapter explains how to display measurement data in various formats. Each of the two display screen panes may be programmed independently.

NOTE:

The instructions in this chapter assume that the left display pane is active. If the right display pane is active, simply change all [F1]-[F4] designations to [F5]-[F8].

The following submenus are included in the display menu:

- **BIG** - displays a single measurement in large size text
- **DUAL** - permits the simultaneous display of two measurements, in the same screen pane, in standard size text
- **GRAPH** - displays a graph of either velocity or volumetric flow versus time
- **LOG** - displays the data stored in a log file either graphically or numerically
- **SIGNL** - graphically displays any one of five transducer signals versus time
- **BACKL** - sets the time that the LCD display backlight remains on before it is automatically turned off.
- **SLEEP** - blanks out the display screen until a key is pressed.

Refer to figure 15, and proceed to the appropriate section to set up the model GF868 display screen(s), using one of the listed submenus.

2.2 The BIG submenu

The BIG format, which is the model GF868's default power up format, displays one measurement in large print. To select the BIG format and the measurement to display in this format, follow the instructions in this section.

Upon power up, a standard measurement mode display (similar to the one shown below) appears. Press the appropriate side of the [SCREEN] key to activate the desired pane of the display screen, and complete the following steps:

site label site file ▶

Velocity Ft/s

6.95

(error codes appear here)

VEL | VOLUM | +TOTL | -TOTL

The default power up screen is already in BIG mode. If a different display mode is active, access the *display menu* by pressing the [DISP] key.

DISPLAY FEATURES ▶

DISPLAY FORMAT

previous selection appears here

BIG | DUAL | GRAPH | LOG

Press [F1] to select the BIG option. The measurement mode screen reappears with the display in the BIG format.

site label site file ▶

Velocity Ft/s

6.95

(error codes appear here)

VEL | VOLUM | +TOTL | -TOTL

Use the [F1]-[F4], [←] and [→] keys to select the desired display parameter option. See table 9 for a complete description of the available options.

2.3 The DUAL submenu

The DUAL format displays two measurements simultaneously in normal print. To select the DUAL format and the measurements to display in this format, follow the instructions in this section.

Upon power up, a standard measurement mode display (similar to the one shown below) appears in BIG format. Press the appropriate side of the [SCREEN] key to activate the desired pane of the display screen, and complete the following steps:

1. To access the *display menu*, press the [DISP] key.
2. Press [F2] = DUAL. The measurement mode display reappears and the display is now in the DUAL format.
3. Use the [F1]-[F4], [←] and [→] keys to select the desired display parameter option. See table 9 for a complete description of the available options.

Table 9: Measurement parameter options

Option bar choice	Description
[F1] = VEL	Flow velocity
[F2] = VOLUM	Volumetric flow
[F3] = +TOTL	Forward totalized volume flow
[F4] = -TOTL	Reverse totalized volume flow
[→] + [F1] = TIME	Total flow measurement time
[→] + [F2] = MDOT	Mass flow
[→] + [F3] = +MASS	Forward totalized mass flow
[→] + [F4] = -MASS	Reverse totalized mass flow
[→] + [→] + [F1] = DIAG	Diagnostic

NOTE:

See chapter 3, *operation*, of the *startup guide* for more details on selecting a measurement parameter to display.

NOTE:

See chapter 3, *operation*, of the *startup guide* for more details on selecting a measurement parameter to display.

With the DUAL format display screen active, when a measurement parameter is selected, the top line of the prompt area will be changed to show that parameter. The parameter previously displayed at the top of the display is moved to the bottom of the display, and the previous bottom parameter is no longer shown.

2.4 The GRAPH submenu

The GRAPH submenu permits the display of either the flow velocity, mass flow or the volumetric flow on an XY bar graph, with a specified time interval on the x-axis. This section describes the procedures for setting up and using the graph format.

2.4.1 Setting up the GRAPH Format

Press the appropriate side of the [SCREEN] key to activate the desired pane of the display screen, and complete the following steps:

1. To access the *display menu*, press the [DISP] key.
2. Press [F3] = GRAPH.
3. Press [F1]-[F3] to graph the flow *velocity*, *volumetric flow* or *mass flow*, respectively.
4. Use the [←], [→] and [F1]-[F4] keys to select the desired *time increment*.
5. Enter a maximum value for the Y-axis (vertical) scale that is larger than the maximum expected reading and press [ENT].
6. At the Y *range* prompt, press [F1] to graph only positive Y values or press [F2] to graph both positive and negative Y values.

After the Y RANGE is entered, the model GF868 automatically begins taking measurements and displays them in the specified graphical format. Proceed to the next section for a discussion of manipulating the graphical display.

2.4.2 Using the GRAPH format

While viewing data in the GRAPH format, the function keys are programmed to permit a variety of actions. These options are described in detail below.

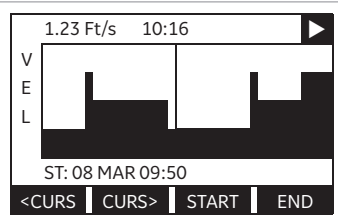

Use the [←], [→] and [F1]-[F4] keys to select the desired option. See table 10 for a listing of the available choices.

At any given time, 120 data points will be shown on the GRAPH screen. The cursor, which is displayed as a vertical line that extends the full height of the graph window, can be used to select any one of these data points.

The typical screen shown above is for a *velocity vs. time* graph with only the positive y-axis displayed. The measurement parameter (VEL) is shown to the left of the y-axis and there is a *message line* below the graph that initially indicates the starting date and time of the graphed data. Notice that most of the locator bar has been replaced by a *status line* in standard video that shows the value, units and time of the measurement at the current cursor location.

However, there is an inverse video *pointer* at the far right of this line to indicate that additional option bar choices are available.

NOTE:

The date in the message line includes only the day and the month (not the year), and the times in the status line and the message line include only the hours and minutes (not the seconds).

Because the times displayed in the GRAPH format are in whole minutes only, movement of the cursor may not result in a visible change in the posted times. For example, if a TIME INCREMENT of 30 seconds has been programmed, two presses of either cursor movement key will be required to change the displayed time by one minute.

Table 10: Graph display options

Option bar choice	Description
[F1] = <CURS	Moves the cursor to the left and displays the corresponding measurement value and time in the status line: (i.e. 6.85 Ft/s 10:38)
[F2] = CURS>	Moves the cursor to the right and displays the corresponding measurement value and time in the status line: (i.e. 5.31 Ft/s 10:38)
[F3] = START	Moves the cursor all the way to the left side of the graph and posts the starting date and time in the message line: (i.e. ST: 08 MAR 10:38)
[F4] = END	Moves the cursor all the way to the right side of the graph and posts the ending date and time in the message line: (i.e. END 08 MAR 11:14)
[→] + [F1] = YMAX	Displays the programmed maximum Y value in the message line: (i.e. YMAX 25.0 Ft/s)
[→] + [F2] = T INC	Displays the programmed time increment value in the message line: (i.e. T INC 30 seconds)
[→] + [F3] = EXIT	Leaves the GRAPH format and returns the display to the previous data format. (The [EXIT] key on the keypad will also perform this function.)

2.5 The LOG submenu

The LOG submenu permits the display of the data in a log file either graphically or numerically. Although the model GF868 can display all of the data in a log file, screen size limitations prevent the simultaneous display of the complete log file. Therefore, the function keys must be used to view the remaining data. Follow the instructions in this section to display a log file in the desired format.

2.5.1 Entering the LOG submenu

Press the appropriate side of the [SCREEN] key to activate the desired pane of the display screen, and complete the following steps:

1. To access the *display menu*, press the [DISP] key.
2. Press [F4] = LOG.
3. Use the [←], [→] and [F1]-[F4] keys to select the desired log file to display. At the NAME prompt, the option bar will show the names of all log files that are currently stored in memory. If there are no log files currently stored in memory, the following prompt will appear instead:

```

DISPLAY FEATURES
DISPLAY FORMAT
logging
All Logs Cleared!
hit key
        
```

There are no log files currently stored in memory. Either all of the log files have been cleared or no log files have yet been created. Press any key to return to measurement mode.

If the all logs cleared! prompt appears, at least one log file must be created and stored in memory before the *display log* function can be accessed. See chapter 3, logging data, for instructions on creating a log file. After at least one log file is stored in memory and selected at the NAME prompt of the LOG submenu, proceed to the next step.

4. At the *format* prompt, press [F1] to display the selected log in numeric format or press [F2] to display the selected log in graphical format.
5. Do one of the following:
 - If you pressed [F1], go to 2.5.2 Numeric format for details.
 - If you pressed [F2], go to 2.5.3 Graphical format for details.

2.5.2 Numeric format

The model GF868 can log up to three parameters simultaneously. Each set of data values is called a record, and up to 120 consecutive records can be stored in a page. A log file can consist of up to 120 pages. The numeric log display, which shows one record at a time, includes the following components:

- page number
- record number
- time and date of creation
- measurement value set
- error messages (if any)

Upon choosing NUM at the FORMAT prompt, the first record of the selected log file is displayed in a screen similar to the following:

```

PAGE# 1      REC# 80
              09 MAR 98
              11.66 Ft/s
              1.32 KACF/MI
              6.91 KACF
E5: Amplitude
<CURS CURS> <PAGE PAGE>
        
```

Use the [←], [→] and [F1]-[F4] keys to view additional records or to exit the log display. The options are listed in table 11.

In the numeric display screen, the locator bar (except for the inverse video pointer at the far right) is replaced by a standard video display of the page number and record number. The first line of the prompt area shows the time and date that the record was created, and the next three lines list the values for the three logged parameters.

Finally, any error condition that existed at the time the record was taken is indicated by an error code in the bottom line of the prompt area.

Table 11: Numeric log display options

Option bar choice	Description
[F1] = <CURS	Display the previous record on the current page
[F2] = CURS>	Display the next record on the current page
[F3] = <PAGE	Display the previous page
[F4] = PAGE>	Display the next page
[→] + [F1] = START	Display the first record on the current page
[→] + [F2] = END	Display the last record on the current page
[→] + [F3] = EXIT	Leave the numeric LOG display and return to the previous data format. (The [EXIT] key on the keypad will also perform this function.)

2.5.3 Graphical format

After choosing PLOT at the FORMAT prompt, the programming sequence continues as follows:

6. Enter a maximum value for the Y-axis (vertical) scale that is larger than the maximum expected reading. Press [ENT].
7. At the Y range prompt, press [F1] to graph only positive Y values or press [F2] to graph both positive and negative Y values.

After the Y RANGE is entered, the model GF868 automatically displays the chosen log file records in the specified graphical format.

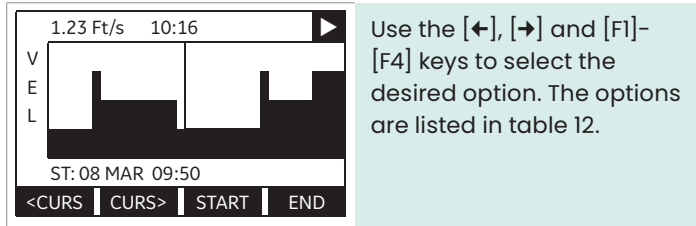

At any given time, the 120 records stored in one page of the log file will be graphed on the display screen. The *cursor*, which is shown as a vertical line that extends the full height of the graph window, can be used to highlight any one of these records.

IMPORTANT:

Only the first of the three logged parameters is displayed in the graphical format of the LOG submenu.

Therefore, when creating a log file, be sure to specify the parameter to be graphed at the 1st value logged prompt. See chapter 3, logging data, for details on creating a log file.

In the typical graphical display shown, the first logged parameter (VEL) is shown to the left of the y-axis and there is a message line below the graph that initially indicates the starting date and time of the current page. Notice that most of the locator bar has been replaced by a status line in standard video that shows the value, units and time of the record at the current cursor location. However, there is still an inverse video pointer at the far right of this line to indicate that additional option bar choices are available.

NOTE:

The date in the message line includes only the day and the month (not the year). The times in the status line and the message line include only hours and minutes (not seconds).

Because the times displayed in the LOG graph are in whole minutes only, movement of the cursor may not result in a visible change in the posted times. For example, if a TIME INCREMENT of 30 seconds has been programmed, two presses of either cursor movement key will be required to change the displayed time by one minute.

Table 12: Graphical log display options

Option bar choice	Description
[F1] = <CURS	Move the cursor one record to the left and display the value and time of that record in the status line: (i.e. 6.85 Ft/s 10:38)
[F2] = CURS>	Move the cursor one record to the right and display the value and time of that record in the status line: (i.e. 5.31 Ft/s 10:38)
[F3] = <PAGE	Display the previous page of records
[F4] = PAGE>	Display the next page of records
[→] + [F1] = START	Move the cursor to the first record on the current page and post the date and time of that record in the message line: (i.e. ST: 08 MAR 10:38)
[→] + [F2] = END	Move the cursor to the last record on the current page and post the date and time of that record in the message line: (i.e. END 08 MAR 11:14)
[→] + [F3] = YMAX	Display the programmed maximum Y value in the message line: (i.e. YMAX 25.0 Ft/s)
[→] + [F4] = T INC	Display the time increment value, as set when the log file was created, in the message line: (i.e. T INC 30 seconds)
[←] + [F1] = EXIT	Leave the graphical LOG display and return the display to the previous data format. (The [EXIT] key on the keypad will also perform this function.)

2.6 Displaying the transducer signal

The SIGNAL submenu permits the direct graphical display of several transducer signals. Specifically, the signals listed in table 13 may be viewed in this format.

Table 13: Available transducer signals

Transducer signal	Description
Skam types	
Sup	upstream skan signal
Sdown	downstream skan signal
Cup	upstream skan correlation
Cdown	downstream skan correlation
Measure types	
Mup	upstream measure signal
Mdown	downstream measure signal

NOTE:

The measure type signals (Mup and Mdown) are available only if the S/M burst technique was selected in the ACTIV menu.

Refer to figure 15 and complete the following steps to display the transducer signals. Press the appropriate side of the [SCREEN] key to activate the desired pane of the display screen, then proceed as follows:

NOTE:

For this discussion, it is assumed that the left pane of the display screen is active. If the right pane is active, it is only necessary to replace the [F1]-[F4] keys designations by the [F5]-[F8] keys.

1. To access the *display menu*, press the [DISP] key.
2. Press [→] and [F1] = SIGNAL.
3. Press [F1] to display the skan type signals or press [F2] to display the measure type signals.

NOTE:

If the skan burst technique was selected in the ACTIV menu, the signal to display prompt does not appear and the measure type signals are not available. To access these signals, the S/M burst technique must be selected.

The signal graph is a plot of signal amplitude (y-axis) vs. time in microseconds (x-axis). When the SIGNAL display screen first appears, it may briefly remain blank. As soon as the signal is acquired, processed and loaded into the display memory, the graph will appear. A cursor, which is displayed as a vertical line that extends the full height of the graph window, is used to highlight any point in time along the x-axis.

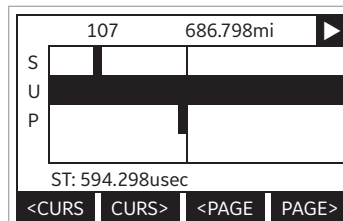

Use the [←], [→] and [F1]-[F4] keys to select the desired option. The options are listed in table 14.

The typical display screen shown has the sup transducer signal listed to the left of the y-axis and there is a *message line* below the graph that initially indicates the starting date and time of the graphed signal. Notice that most of the locator bar has been replaced by a status line in standard video that shows the signal amplitude and the time (in microseconds) of the measurement at the current cursor location. However, there is still an inverse video pointer at the far right of this line to indicate that additional option bar choices are available.

Table 14: Graphical log display options

Option bar choice	Description
[F1] = <CURS	Move the cursor to the left and display amplitude and time in the status line: (i.e. 107 686.798mi)
[F2] = CURS>	Move the cursor to the right and display amplitude and time in the status line: (i.e. 107 686.798mi)
[F3] = <PAGE	Display the previous page
[F4] = PAGE>	Display the next page
[→] + [F1] = START	Move the cursor to the start of the current page and post the starting date and time in the message line: (i.e. ST: 451.798usec)
[→] + [F2] = END	Move the cursor to the end of the current page and post the ending date and time in the message line: (i.e. END: 744.298usec)
[→] + [F3] = YMAX	Display the maximum Y value, set to 128 divisions in arbitrary units, in the message line.
[→] + [F4] = T INC	Display the time increment value in the message line. This is based on the frequency of the transducers (equal to 0.125 μsec for a 1 MHz transducer).
[←] + [F1] = EXIT	Leave the graphical SIGNAL display and return the display to the previous data format. (The [EXIT] key on the keypad will also perform this function.)

In addition to the functions available on the option bar, some of the numeric keys are used to specify which transducer signal is displayed and to scale the resulting graph. Table 15 lists these functions.

Table 15: Numeric key functions

Key	Function
1	Scroll down the transducer signal list
2	Scroll up the transducer signal list
4	Expand the graph vertically
5	Return expanded graph to previous size
7	Compress graph horizontally
8	Return compressed graph to previous size

In summary, three basic functions are performed with the numeric keys:

- **Signal selection:** use the “1” and “2” keys to select a transducer signal for display by scrolling through the list of available signals.
- **Vertical scaling:** The “4” and “5” keys are used to scale the graph vertically. Each press of the “4” key doubles the height of the graph, while each press of the “5” key halves the height of the graph. The three available scale factors are 1x, 2x and 4x.
- **Horizontal scaling:** The “7” and “8” keys are used to scale the graph horizontally. Each press of the “7” key doubles the T INC value (2x horizontal compression), while each press of the “8” key halves the T INC value (2x horizontal expansion). The four available compression ratios are 1x, 2x, 4x and 8x.

To return to the standard data screen either select EXIT from the option bar or press the [EXIT] key on the keypad.

2.7 Setting the LCD backlight

Use the BACKL submenu to specify the number of minutes the LCD display backlight remains on before it is automatically turned off. Press the appropriate side of the [SCREEN] key to activate the desired pane of the display screen, then proceed as follows:

NOTE:

For this discussion, it is assumed that the left pane of the display screen is active. If the right pane is active, replace the [F1]-[F4] keys designations by the [F5]-[F8] keys.

1. To access the *display menu*, press the [DISP] key.
2. Press [→] and [F2] = BACKL.
3. Use the numeric keys to enter a value from 1 to 60 minutes and press [ENT]. To keep the backlight on constantly, enter a value of 0 and press [ENT].

The model GF868 will automatically return to the previous data display screen and the programmed backlight time-out interval will begin.

If no entries are made from the keypad before the backlight time-out interval expires, the backlight will automatically be turned off. At the next keypad entry, the backlight will be turned on and the specified time-out interval will begin again.

2.8 Activating sleep mode

During times when the display is not in use, use the SLEEP submenu to temporarily suspend LCD display activity, which allows the model GF868 to process data more quickly. Press the appropriate side of the [SCREEN] key to activate the desired pane of the display screen, then proceed as follows:

NOTE:

For this discussion, it is assumed that the left pane of the display screen is active. If the right pane is active, replace the [F1]-[F4] keys designations by the [F5]-[F8] keys.

1. To access the *display menu*, press the [DISP] key.
2. Press [→] and [F3] = SLEEP. The message "LCD SLEEP MODE -Press any key. . ." appears.
3. To reactivate the display and return to the previous data screen, press any key on the keypad. The model GF868 will automatically return to the previous data display screen.

NOTE:

With BIG as the selected display format, exiting SLEEP mode may not erase the sleep mode message and the data screen will be superimposed on the message. If this occurs, simply enter the DISP menu and reselect the BIG format to refresh the screen. See the instructions earlier in this chapter.

Chapter 3. Logging data

3.1 Introduction

This chapter explains how to use the model GF868's data logging capability. The LOG menu, which is accessed by pressing the [LOG] key on the keypad, is divided into four submenus:

- **STD** - used to log up to three of the available measurement data parameters
- **MEM** - used to check the data logger memory to determine if the specified log will exceed the available memory
- **STOP** - used to terminate current data logging activity
- **ERROR** - used to log any generated error messages.

Up to twenty standard or error log files may be created and stored in battery-backed memory. Each log file contains up to three measurement parameters, the log start time and date, the log end time and date, the time interval between updates, and any error messages. error logs record data only when an error message is generated.

The model GF868 allocates up to 120 pages of memory, each of which can contain up to 120 records, for data logging. Each page is assigned a header, to distinguish one page from another. The header contains the log title, start date and time, end date and time, and the time increment. Each record contains the date and time of the measurement and the values for the three logged parameters.

NOTE:

Each log file uses at least one page of memory, and the same page can not be shared by two different logs.

Since a fixed amount of memory is allocated for data logging, the number of active logs, the log time increments, and the length of the log runs will all affect how much memory is available for additional logging. For example, a log that updates every 5 seconds will use more memory than a log that updates every 6 minutes, assuming that they both run for the same length of time.

After a log file has been created, it may be displayed, printed, cleared or uploaded to a personal computer. Refer to the appropriate chapters of this manual for specific instructions.

Refer to figure 17 in Appendix A, *menu maps*, and proceed to the appropriate section for the desired LOG submenu. Each submenu may be followed in the sequence shown or the [↑] and [↓] keys may be used to scroll through the prompts.

3.2 Creating a standard log

Use the STD submenu to create a new standard log and to select the parameters to log, the log start time and date, the log end time and date, and the time increment. Also, any log file already stored in memory may be inspected and/or changed.

Press the appropriate side of the [SCREEN] key to activate the desired pane of the display screen, and complete the following steps:

1. To access the *log menu*, press the [LOG] key.
 - a. If you have activated the security feature (see chapter 1, programming site data, for details), enter the assigned password and press [ENT].
2. Press [F1] = STD.
3. Use the [←], [→] and [F1]-[F4] keys to inspect a completed log or to change an active log, or enter a new name (up to 5 characters) and press [ENT] to create a new log file.

NOTE:

At the NAME prompt, the option bar will show the names of all completed or active log files that are currently stored in memory. Recall that a flashing asterisk (*) appears at the far right of the locator bar if the model GF868 is currently logging data (see chapter 3, *operation*, of the *startup guide*).

4. At the log message prompt, enter a brief description (up to 21 characters) of the log. press [ENT].
5. Use the [←], [→] and [F1]-[F4] keys to select the first parameter to be logged. See table 16 for a list of the available options.

IMPORTANT:

Only the **first** parameter logged may be graphically displayed in the LOG submenu of the display menu.

Keep this in mind when selecting a parameter. See chapter 2, *displaying data*, for instructions.

Table 16: Measurement parameter options

Option bar choice	Description
[F1] = VEL	Flow velocity
[F2] = VOLUM	Volumetric flow
[F3] = +TOTL	Forward totalized volume flow
[F4] = -TOTL	Reverse totalized volume flow
[∅] + [F1] = MDOT	Mass flow
[∅] + [F2] = +MASS	Forward totalized mass flow
[∅] + [F3] = -MASS	Reverse totalized mass flow
[∅] + [F4] = DIAG	Diagnostic

Refer to chapter 3, *diagnostics*, of the service manual for a discussion of the many parameters accessible via the DIAG option.

NOTE:

The units assigned to the parameters in table 16 are those selected in the User program (SYSTEM submenu)

6. Use the [←], [→] and [F1]-[F4] keys to select the second parameter to be logged.
7. Use the [←], [→] and [F1]-[F4] keys to select the third parameter to be logged.
 - If you selected a totalized value for display, go to step 8.
 - If you did not, go to step 9.
8. At the Set log totals to 0 prompt, press [F1] to leave the log totals at their present value or press [F2] to reset the log totals to zero. Choosing YES at this prompt only resets the log totals to zero and has no effect on the meter totals.

3.2.1 Log type

9. Press [F1] to create a non-circular log or press [F2] to create a circular log.

A non-circular log automatically stops when the meter runs out of memory or the specified END TIME is reached. A circular log runs continuously until manually stopped, but only the data from the most recent log cycle is saved. At the start of each cycle, the oldest recorded data is overwritten by the new data from the current cycle.



CAUTION!

If data from one circular log cycle exceeds the meter's memory capacity, the earliest logged data will be lost.

3.2.2 STARTTIME prompt

10. Press [F1] to accept the displayed start time or press [F2] to enter a different start time. To start logging immediately, press [F3].
 - If OK was selected, proceed to step 11.
 - If NOW was selected, proceed to step 12 if you selected a the non-circular log or to step 14 for a circular log.
 - If EDIT was selected, complete the steps listed below.
 - a. Press [F1]-[F2] to select AM or PM. Then, enter the desired hour (1-12) and press [ENT]. (Entry of a start time earlier than the current time will generate an error message.)
 - b. Enter the desired *minutes* and press [ENT]. The acceptable range is 0 to 59.
 - c. Enter the desired *seconds* and press [ENT]. The acceptable range is 0 to 59.

3.2.3 START DATE prompt

11. Press [F1] to accept the displayed *start date* or press [F2] to enter a different start date. To start logging today, press [F3].
 - If OK or TODAY was selected, proceed to step 12 for a non-circular log or to step 13 for a circular log.
 - Otherwise, complete the following steps to edit the start date.
 - a. Enter the desired year and press [ENT]. The acceptable range is 0 to 99.
 - b. Use the [←], [→] and [F1]-[F4] keys to select the desired month.
 - c. Enter the desired *day* and press [ENT]. The acceptable range is 1 to the number of days in the selected month (28, 29, 30 or 31).

3.2.4 END TIME prompt

12. Press [F1] to accept the displayed *end time* or press [F2] to enter a different end time. To select a specific time period for the log to run, press [F3].
 - If OK was selected, proceed to the END DATE prompt.
 - If TIMED was selected, proceed to the LOG TIME prompt.
 - If EDIT was selected, complete the steps on the next page.

NOTE:

The log END TIME must exceed the log START TIME by at least five minutes. Failure to observe this restriction will result in an error message.

- a. Press [F1]-[F2] to select AM or PM. Then, enter the desired *hour* (1-12) and press [ENT]. (Entry of a start time earlier than the current time will generate an error message.)
- b. Enter the desired *minutes* and press [ENT]. The acceptable range is 0 to 59.
- c. Enter the desired *seconds* and press [ENT]. The acceptable range is 0 to 59.

3.2.5 END DATE prompt

13. Press [F1] to accept the displayed end date or press [F2] to enter a different end date. To end the log today, press [F3].
 - If OK or TODAY was selected, proceed to the TIME INCREMENT prompt. Refer to figure 17 in Appendix A, *menu maps* for a flow diagram of the programming sequences.
 - Otherwise, complete the steps below.
 - a. Enter the desired *year* and press [ENT]. The acceptable range is 0 to 99.
 - b. Use the [←], [→] and [F1]-[F4] keys to select the desired *month*.
 - c. Enter the desired *day* and press [ENT]. The acceptable range is 1 to the number of days in the selected month (28, 29, 30 or 31). The program proceeds to step 15.

3.2.6 DURATION prompt

If a circular log was specified, the programming sequence continues here after the log start time and/or start date is entered.

14. Press [F1] and enter a log duration in hours or press [F2] and enter a log duration in days. When the desired value has been entered, press [ENT]. The program proceeds to step 16.

3.2.7 LOG TIME prompt

If TIMED was selected at step 12, the programming sequence continues here.

15. Use the [←], [→] and [F1]-[F4] keys to select the desired log duration. The available options are: 10min, 30min, 60min, 3 HR, 6 HR, 12 HR and 24 HR.

3.2.8 TIME INCREMENT prompt

Regardless of which of the various options were selected during the previous programming steps, all of the paths converge at this point.

16. Use the [←], [→] and [F1]-[F4] keys to select the desired time increment. The available options are: 5sec, 10sec, 30sec, 1min, 3min, 6min, 12min, 30min and 60 min.

The time increment is the frequency at which the model GF868 takes and records data measurements. If any reading takes longer than the programmed time increment, the log is filled in with the next consecutive reading. For example, assume that a velocity value of 3 ft/sec is recorded at 12:00:00 in a log with a time increment of five seconds. If the next reading is 8 ft/sec and it takes the meter 12 seconds to read this value, then both of the missed readings (12:00:05 and 12:00:10) will be filled in with the 8 ft/sec value.

3.2.8a Procedure options

You have completed entering data for a standard log. You can now do one of the following:

- Use [↑] and [↓] to review the previous menu prompts.
- Press [F1]-[F4] to select one of the LOG submenus.
- To return to the data screen and begin logging data, press the [ENT] key.

Although each log is restricted to only three logged parameters, it is still possible to log more than three parameters. Simply reenter the STD submenu as many times as necessary to set up additional logs. Select the other desired parameters, and run these logs simultaneously with the first log.

3.3 Checking the memory

Use the MEM submenu to verify that the available log memory is sufficient for the desired log. If the expected amount of logged data will exceed the remaining memory capacity, the model GF868 suggests that some old logs be cleared to make room for the new log.

Press the appropriate side of the [SCREEN] key to activate the desired pane of the display screen, and complete the following steps:

1. To access the *log menu*, press the [LOG] key.
 - a. If you have activated the security feature (see chapter 1, *programming site data*, for details), enter the assigned password and press [ENT].
2. Press [F2] = MEM.
3. After noting the information, press [ENT] to return to the main *log menu* screen.

The MEM screen lists the number of remaining unused memory pages out of the total number of 120 available pages. Also, the number of pages expected to be used by all currently programmed logs is given. If the number of pending pages exceeds the number of free pages, additional memory may be made available by clearing some old logs (see chapter 5, *clearing data*).

If it is undesirable to delete old logs to free up additional memory, the number of pages pending may be reduced by altering the parameters of one or more of the currently active logs. For example, either increasing the time increment or decreasing the total logging time will reduce the memory requirements for a log file. Use the following equations to calculate the number of pages used by a log:

$$\text{number of records} = \frac{\text{length of log}}{\text{time increment}} \quad (1)$$

$$\text{number of pages} = \frac{\text{number of records}}{120} \quad (2)$$

Consider a log that is set to run for 24 hours with a time increment of 3 minutes. From equation 1, the number of records = $(24 \times 60)/3 = 480$ records. Then, from equation 2, the number of pages = $480/120 = 4$ pages. Thus, at least four pages of memory must be available for this log to run to completion. Notice that increasing the time increment to 6 minutes or decreasing the length of the log to 12 hours would reduce the memory requirement to only 2 pages.

3.4 Stopping a log

Use the STOP submenu to terminate a logging process that is currently active. Press the appropriate side of the [SCREEN] key to activate the desired pane of the display screen, and complete the following steps:

1. To access the *log menu*, press the [LOG] key.
 - a. If you have activated the security feature (see chapter 1, *programming site data*, for details), enter the assigned password and press [ENT].

NOTE:

Once a log is stopped it cannot be restarted, but the log remains in memory. To clear the log from memory, refer to chapter 5, *clearing data*, for instructions.

2. Press [F3] = STOP.
3. Use the [←], [→] and [F1]-[F4] keys to select a log file to stop.

NOTE:

At the NAME prompt, the option bar will show the names of all completed or active log files that are currently stored in memory. Recall that a flashing asterisk (*) appears at the far right of the locator bar if the model GF868 is currently logging data (see chapter 3, *operation*, of the *startup guide*).

4. Press [F1] to continue logging and return to the initial *log menu* screen. Press [F2] to stop logging and return to the initial *log menu* screen.

3.4.0a Procedure options

Do one of the following:

- Press [F1]-[F4] to enter another LOG submenu.
- Press [EXIT] to return to the data screen.

3.5 Creating an ERROR log

Use the ERROR submenu to create a new error log and to select the logging parameters. An error log updates every 5 seconds (when the display updates), but only if a new error condition occurs. Error logs have a fixed length of 2 pages and contain sixty records per page. Each record shows the time of the error, the measurement parameter values at that time, and the error code message. The logged values of the chosen measurement parameters at the time of the error condition provide valuable troubleshooting information.

Press the appropriate side of the [SCREEN] key to activate the desired pane of the display screen, and complete the following steps:

1. To access the log menu, press the [LOG] key.
 - a. If you have activated the security feature (see chapter 1, programming site data, for details), enter the assigned password and press [ENT].
2. Press [F4] = ERROR.
3. Use the [←], [→] and [F1]-[F4] keys to inspect a completed log or to change an active log, or enter a new name (up to 5 characters) and press [ENT] to create a new log file.

NOTE:

The option bar lists all error logs currently stored in memory. Recall that a flashing asterisk (*) appears at the far right of the locator bar if the model GF868 is currently logging data (see chapter 3, operation, of the startup guide).

4. At the log message prompt, enter a brief description (up to 21 characters) of the log. Press [ENT].
5. Use the [←], [→] and [F1]-[F4] keys to select the first parameter to be logged. See table 17 for a list of the available options.

IMPORTANT:

Only the **first** parameter logged may be graphically displayed (see chapter 2, displaying data).

Table 17: Measurement parameter options

Option bar choice	Description
[F1] = VEL	Flow velocity
[F2] = VOLUM	Volumetric flow
[F3] = +TOTL	Forward totalized volume flow
[F4] = -TOTL	Reverse totalized volume flow
[∅] + [F1] = MDOT	Mass flow
[∅] + [F2] = +MASS	Forward totalized mass flow
[∅] + [F3] = -MASS	Reverse totalized mass flow
[∅] + [F4] = DIAG	Diagnostic

In addition, refer to chapter 3, diagnostics, of the service manual for a discussion of the many parameters accessible via the DIAG option.

NOTE:

The units assigned to the parameters in table 17 are those selected in the User program (SYSTEM submenu).

6. Use the [←], [→] and [F1]-[F4] keys to select the second parameter to be logged.
7. Use the [←], [→] and [F1]-[F4] keys to select the third parameter to be logged.
 - If you selected a totalized value for display, go to step 8.
 - If you did not, go to step 9.
8. At the *set log totals to 0* prompt, press [F1] to leave the log totals at their present value or press [F2] to reset the log totals to zero. Choosing YES at this prompt only resets the log totals to zero and has no effect on the meter totals.

3.5.1 Log type

9. Press [F1] to create a non-circular log or press [F2] to create a circular log.

A non-circular log automatically stops when the meter runs out of memory or the specified END TIME is reached. A circular log runs continuously until manually stopped, but only the data from the most recent log cycle is saved. At the start of each cycle, the oldest recorded data is overwritten by the new data from the current cycle.



CAUTION!

If data from one circular log cycle exceeds the meter's memory capacity, the earliest logged data will be lost.

3.5.2 STARTTIME prompt

10. Press [F1] to accept the displayed start time or press [F2] to enter a different start time. To start logging immediately, press [F3].
- If OK was selected, proceed to step 11.
 - If NOW was selected, you have finished setting up the error log. Proceed to *procedure options*.
 - If EDIT was selected, complete the steps listed on the next page.
 - a. Press [F1]-[F2] to select AM or PM. Then, enter the desired *hour* (1-12) and press [ENT]. (Entry of a start time earlier than the current time will generate an error message.)
 - b. Enter the desired *minutes* and press [ENT]. The acceptable range is 0 to 59.
 - c. Enter the desired *seconds* and press [ENT]. The acceptable range is 0 to 59.

3.5.3 START DATE prompt

11. Press [F1] to accept the displayed start date or press [F2] to enter a different start date. To start logging today, press [F3].
- If OK or TODAY was selected, you have finished setting up the error log. Proceed to *procedure options* below.
 - Otherwise, complete the following steps to edit the start date.
 - a. Enter the desired year and press [ENT]. The acceptable range is 0 to 99.
 - b. Use the [←], [→] and [F1]-[F4] keys to select the desired month.
 - c. Enter the desired day and press [ENT]. The acceptable range is 1 to the number of days in the selected month (28, 29, 30 or 31).

3.5.3 a Procedure options

You have completed setting up the error log. Do one of the following:

- Use [↑] and [↓] to review the previous menu prompts.
- Press [F1]-[F4] to select one of the LOG submenus.
- To return to the data screen and begin logging data, press the [ENT] key. The * on the locator bar indicates that the model GF868 is now compiling the specified error log.

The error log will continue to run until it is manually stopped, the meter runs out of memory (for a non-circular log), or the entire 120 records (2 pages x 60 records/page) have been logged.

Chapter 4. Printing data

4.1 Introduction

The model GF868 flowmeter has the capability to print any of the data stored in its memory via the built-in RS232 communications port. In order to use the function, the RS232 port must be connected to a printer with a serial port input. A printer with a parallel port input may be used with a third-party serial-to-parallel adapter.

NOTE:

See chapter 1, installation, of the *startup guide* for instructions on wiring the RS232 port. For additional information, refer to chapter 6, serial communications.

After connecting the model GF868 to a printer, the print menu is used to print live or logged data in either numeric or graphical format. In addition, any site files stored in memory may be printed. The *print menu* is divided into the following submenus:

- **DATA** - use to print live data in numeric or graphical format
- **LOG** - use to print a log file in numeric or graphical format
- **PROG** - use to print a site file
- **STOP** - use to terminate any active print jobs
- **PRNTR** - use to specify the printer currently connected
- **SGNLS** - use to print transducer signal array data
- **RTDs** - use to send the numeric point value of a connected RTD device to the RS232 port.

For purposes of this discussion it is assumed that the left pane of the data display screen is active. If the right pane of the data display screen is active, all of the instructions remain the same, except that any references to the [F1]-[F4] keys should be replaced by the [F5]-[F8] keys.

Refer to figure 16 in Appendix A, menu maps, and proceed to the desired section for detailed instructions. As an additional aid, the relevant portion of the full menu map is reproduced in each section of this chapter. Any submenu may be followed in the sequence shown or the [↑] and [↓] keys may be used to scroll through the prompts.

NOTE:

If a printer has not yet been set up, the instructions in "The PRNTR submenu" must be completed before proceeding to any of the other submenus.

4.2 Print live data

Use the DATA submenu to print live measurement data, as it is collected. The data may be printed in either numeric or graphical format, with a user specified time increment.

IMPORTANT:

Make sure that a printer has been properly set up before proceeding with this section.

To print live measurement data, refer to figure 16 of Appendix A, *menu maps*, and complete the following steps:

1. To access the *print menu*, press the [PRNT] key.

NOTE:

The print menu is **not** protected by the security feature and a password is never required to access this menu.

2. Press [F1] to select the DATA option.
3. Press [F1] = NUM to print the data in numeric format or press [F2] = PLOT to print the data in graphical format.
 - If you press [F1], go to step 4.
 - If you press [F2], go to step 8.

4.2.1 Numeric format

4. Use the [←], [→] and [F1]-[F4] keys to select the first parameter to be printed. See table 18 for a list of the available options.

Table 18: Measurement parameter options

Option bar choice	Description
[F1] = VEL	Flow velocity
[F2] = VOLUM	Volumetric flow
[F3] = +TOTL	Forward totalized volume flow
[F4] = -TOTL	Reverse totalized volume flow
[→] + [F1] = MDOT	Mass flow
[→] + [F2] = +MASS	Forward totalized mass flow
[→] + [F3] = -MASS	Reverse totalized mass flow
[→] + [F4] = DIAG	Diagnostic

Refer to chapter 3, *diagnostics*, of the *service manual* for a discussion of the many parameters accessible via the DIAG option.

NOTE:

The units assigned to the parameters in table 18 are those selected in the User program (SYSTEM submenu).

5. Use the [←], [→] and [F1]-[F4] keys to select the second parameter to be printed.
6. Use the [←], [→] and [F1]-[F4] keys to select the third parameter to be printed.
7. Use the [←], [→] and [F1]-[F4] keys to select the desired time increment (the frequency at which measurements are taken). The available options are: 5sec, 10sec, 30sec, 1min, 3min, 6min and 12min.

After the time increment is chosen, the model GF868 returns to the standard data display screen and continues to take measurements. The live data is printed at the specified time intervals, until a STOP command is issued (see the instructions for the STOP submenu). A portion of a typical printout is shown in figure 3.

```

DATA_DUMP OF (SITE NAME)
Ch1 Channel LABEL Channel Message

Start Date          20 OCT 97
Start Time          03:08:40 PM

                CH1          CH1          CH1
                VOLUM        +TOTL        SNDSP
                ACF/HR        ACF          FT/S

03:08:40 P        686.85      218.92      1039.147
03:08:50 P        666.71      220.83      1039.003
03:09:00 P        662.28      222.70      1039.511
03:09:10 P        675.59      224.84      1039.509
03:09:20 P        669.79      226.71      1039.470
03:09:30 P        675.99      228.58      1039.137
03:09:40 P        670.70      230.45      1039.105
03:09:50 P        684.00      232.57      1039.082
03:10:00 P        680.58      234.46      1039.255
03:10:10 P        678.12      236.34      1038.860
.                .                .                .
.                .                .                .
.                .                .                .
    
```

Figure 3: Typical numeric printout

4.2.2 Graphical format

To print live data in graphical format, continue as follows:

- Use the [←], [→] and [F1]-[F4] keys to select the first parameter to be printed. See table 19 for a list of the available options.

Table 19: Measurement parameter options

Option bar choice	Description
[F1] = VEL	Flow velocity
[F2] = VOLUM	Volumetric flow
[F3] = +TOL	Forward totalized volume flow
[F4] = -TOL	Reverse totalized volume flow
[→] + [F1] = MDOT	Mass flow
[→] + [F2] = +MASS	Forward totalized mass flow
[→] + [F3] = -MASS	Reverse totalized mass flow
[→] + [F4] = DIAG	Diagnostic

Refer to chapter 3, *diagnostics*, of the *service manual* for a discussion of the many parameters accessible via the DIAG option.

NOTE:

The units assigned to the parameters in table 19 are those selected in the user program (SYSTM submenu)

- Enter the desired maximum value for the Y (vertical) axis and press [ENT].

NOTE:

Enter a Y AXIS MAX value that is larger than the largest expected measurement value.

- At the *Y range* prompt, press [F1] to show only the positive Y axis or press [F2] to display both the positive and negative y axis.
- Use the [←], [→] and [F1]-[F4] keys to select the desired *time increment* (the frequency at which measurements are taken). The available options are: 5sec, 10sec, 30sec, 1min, 3min, 6min and 12min.

After the time increment is chosen, the model GF868 returns to the standard data display screen and continues to take measurements. The live data is printed at the specified time intervals, until a STOP command is issued (see the instructions for the STOP submenu). A portion of a typical printout is shown in figure 4.

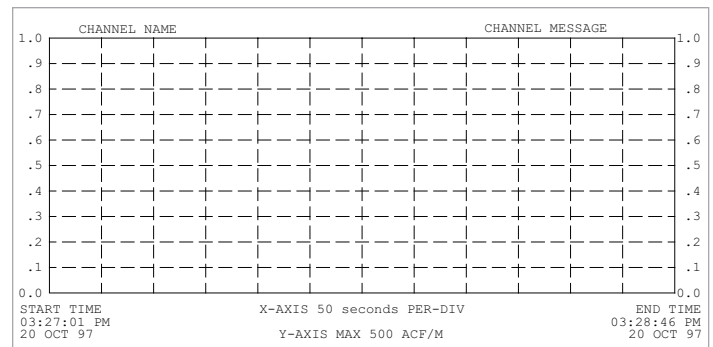

Figure 4: Typical graphical printout

4.3 Printing logs

Use the LOG submenu to print logged measurement data, from a log file in the meter's memory. The data may be printed in either numeric or graphical format, with a user specified time increment.

IMPORTANT:

Make sure that a printer has been properly set up before proceeding with this section.

To print logged measurement data, refer to figure 16 of Appendix A, *menu maps*, and complete the following steps:

1. To access the print menu, press the [PRNT] key.

NOTE:

The print menu is **not** protected by the security feature and a password is never required to access this menu.

2. Press [F2] = LOG.
3. At the format prompt, press [F1] to print the log in numeric format or press [F2] to print the log in graphical format.
4. Use the [←], [→] and [F1]-[F4] keys to select a log file to print.

NOTE:

At the NAME prompt, the option bar shows the names of all completed or active log files currently stored in memory. If an active log is selected for printing, only the data already accumulated at the time of the print command will be printed.

5. Enter the number of the *first page* of the log to print and press [ENT]. (This prompt does not appear if the log file is only one page long.)
6. Enter the total number of log pages to print and press [ENT]. (This prompt does not appear if the log file is only one page long.)
 - If you chose [F1] (numeric) at step 3, see the section below.
 - If you chose [F2] (graphic) at step 3, go to the next page.

4.3.1 Numeric format

After the numeric format (and starting page and number of pages, if applicable) is chosen, the model GF868 returns to the standard data display screen and begins printing the log file. The printout continues until the entire log has been printed or until a STOP command is issued (see the instructions for the STOP submenu). A portion of a typical printout is shown in figure 5.

```

LOG DUMP
LOG NAME   Page# 1

LOG MESSAGE

Start Date   09 SEP 97
Start Time   11:50:43 AM
End Date     09 SEP 97
End Time     11:54:45 PM

                Ch1      Ch1      Ch2
                VOLUM    +TOTL    SNDSP
HH:MM:SS     ACF/HR    ACF      FT/S
11:50:45     600.00    0.00     1000.117
    
```

Figure 5: Typical numeric printout

4.3.2 Graphical format

After the graphical format (and starting page and number of pages, if applicable) is chosen, complete the following additional steps:

1. Enter the desired maximum value for the Y (vertical) axis and press [ENT].

NOTE:

Enter a Y AXIS MAX value that is larger than the largest logged measurement value.

2. At the Y range prompt, press [F1] to show only the positive Y axis or press [F2] to display both the positive and negative y axis.

The model GF868 returns to the standard data display screen and begins printing the log file. The printout continues until the entire log has been printed or until a STOP command is issued (see the instructions for the STOP submenu). A portion of a typical printout is shown in figure 6.

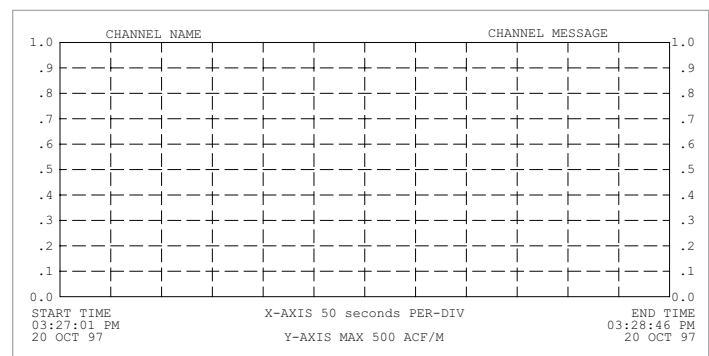

Figure 6: Typical graphical printout

4.4 Print site file

Use the PROG submenu to print the data in a site file that was set up and saved as described in chapter 1, programming site data. To print a site file, refer to figure 16 of Appendix A, menu maps and complete the following steps:

IMPORTANT:

Make sure that a printer has been properly set up before proceeding with this section

1. To access the *print menu*, press the [PRNT] key.

NOTE:

The print menu is **not** protected by the security feature and a password is never required to access this menu.

2. Press [F3] = PROG.
3. Use the [←], [→] and [F1]-[F4] keys to select the desired site file to print.

NOTE:

All site files currently in memory appear on the option bar. The active site file is always listed as the first choice (Work).

The model GF868 returns to the standard data display screen and generates a site file printout similar to the one shown in figure 7. The printout continues until the entire file has been printed or until a STOP command is issued (see the instructions for the STOP submenu.)

```
PROGRAM PARAMETERS of SITE NAME
Model GX868G3G
With 1K FIFO and 1113 receiver board
At 9:54:39 AM on 11 FEB 99

CHAN ACTIVE PARAMETERS

Site status           Burst
Skan/measure mode    Skan Only

CHAN SYSTEM PARAMETERS

Ch1 Channel LABEL Channel MESSAGE
Equation              Standard Equation
Volumetric Units     Thousands ACF
Volumetric Time      /min
VOL Decimal Digits   0
Totalizer Units      Actual cubic ft
TOT Decimal Digits   0
Mass Flow Units       Pounds
Mass Flow Time       /sec
MDOT Decimal Digits  0
```

Figure 7: Typical site file printout

4.5 Stop printing

Use the STOP submenu to terminate the printing of live, logged or site data. To stop any active printing activity, see figure 16 and complete the following steps:

IMPORTANT:

Make sure that a printer has been properly set up before proceeding with this section.

1. To access the print menu, press the [PRNT] key.

NOTE:

The print menu is **not** protected by the security feature and a password is never required to access this menu.

2. Press [F4] = STOP.
3. Press [F1] to continue printing or press [F2] to stop the currently active printing job.

NOTE:

After the STOP command has been issued, the printer will complete the printing of any data already in the printer buffer. Either wait for the printer to finish or turn the printer off to empty the buffer immediately

The model GF868 returns to the standard data display screen and normal measurement taking.

4.6 Setting up a printer

Use the PRNTR submenu to specify the type of printer connected to the model GF868. To set up a printer, refer to figure 16 and complete the following steps:

IMPORTANT:

A printer must be properly set up before proceeding to any of the other sections in this chapter

1. To access the *print menu*, press the [PRNT] key.

NOTE:

The print menu is **not** protected by the security feature and a password is never required to access this menu.

2. Press the [←] or [→] key to display the option bar shown, and then press [F1] to select the PRNTR submenu.
3. Use the [←], [→] and [F1]-[F4] keys to select the desired printer type. See table 20 for a complete list of the available options.

NOTE:

For compatibility with the model GF868, the printer must have an RS232 serial interface. To use a printer with a parallel interface, a serial-to-parallel adapter must be used.

Table 20: Available printer options

Key(s)	Printer type	Description
[F1]	DP411	Seiko model DPU-411 type II
[F2]	XTECH	Extech Mini serial printer 42
[F3]	EPSON	Epson or Epson-compatible
[F4]	KODAK	Kodak Diconix 150 Plus
[→] + [F1]	SP401	Syntest SP-401

After the desired printer type has been selected, the meter returns to the standard data display screen and normal measurement taking.

4.7 Printing signal array data

Use the SGNLS submenu to print signal array data, to help diagnose certain problems. To print the signal data, see figure 16 and complete the following steps:

IMPORTANT:

Make sure that a printer has been properly set up before proceeding with this section.

1. To access the *print menu*, press the [PRNT] key.

NOTE:

The print menu is **not** protected by the security feature and a password is never required to access this menu.

2. Press the [←] or [→] key to display the option bar shown, and then press [F2] to select the SGNLS submenu.
3. Press the [F1]-[F3] keys to select the desired signal array data to print. To abort the procedure, press the [EXIT] key.

NOTE:

The SIGNAL option causes the raw signal array data to print, while the CROSS option causes the cross-correlation data to print. The BOTH option prints both sets of data.

After the desired print selection has been made, the model GF868 returns to the standard data display screen and normal measurement taking. The specified signal array data is printed continuously, until it is manually stopped. To terminate signal array printing, use the STOP submenu, as described earlier in this chapter. A portion of a typical printout is shown in figure 8.

```

CH1      SKAN      SIGNAL
0         2         0
1         2         0
2         2         0
.
.
.
757       40        44
758       41        45
759       40        42
760       34        34
761       32        34
762       36        38
    
```

Figure 8: Typical signal array printout

The data printed via the SIGNAL submenu consists of 1024 lines, each of which lists the following three values:

- **Index** - this is the printout line number, which locates the data point within the complete body of data.
- **Upstream** - this is the amplitude of the signal from the upstream transducer at the listed index number.
- **Downstream** - this is the amplitude of the signal from the downstream transducer at the listed index number.

NOTE:

The printouts generated from the CROSS and BOTH submenus will appear after the SIGNAL printout, as separate listings.

The data printed in this array permits a comparison of the relative signal strengths of the up-stream and downstream transducers, which are used to calculate a single flow measurement.

4.8 Printing RTD data

Use the RTDs submenu to send the numeric point value of a connected RTD device to the RS232 port for display on a terminal or RS232 printer. By viewing the point value of the meter at a given temperature, you can calculate the points at the Set temperature, and the slope of the RTD input in points/degree. (See chapter 1, calibration, of the service manual for more details.)

1. To access the *print menu*, press the [PRNT] key.

NOTE:

The print menu is **not** protected by the security feature and a password is never required to access this menu.

2. Press the [←] or [→] key to display the option bar shown, and then press [F3] to select the RTDs submenu.
3. At the *dump RTD data* prompt, press [F1] to leave the PRINT menu without dumping data, or [F2] to send the RTD data to the RS232 port.

After the selection has been made, the model GF868 returns to the standard data display screen and normal measurement taking. If you have selected YES at the DUMP RTD DATA prompt, the meter continues to send data until you reenter the PRINT menu and select the STOP option.

Chapter 5. Clearing data

5.1 Introduction

This chapter explains how to purge the model GF868's memory of various measurement totals and/or files. The *clear menu*, which is accessed by pressing the [CLR] key on the keypad, is divided into three submenus:

- **TOTAL** - used to reset totalized measurement values
- **SITE** - used to remove site parameter files from memory
- **LOG** - used to clear log files from memory.

NOTE:

For detailed information on creating a log file, see chapter 3, logging data. For detailed information on creating a site file and for setting up the stopwatch totalizer, see chapter 1, programming site data.

For purposes of this discussion it is assumed that the left pane of the data display screen is active. If the right pane of the data display screen is active, all of the instructions remain the same, except that any references to the

[F1]-[F4] keys should be replaced by the [F5]-[F8] keys.

IMPORTANT:

None of the clearing procedures available via the *clear menu* can be undone. Be very sure that the exact consequences of a selected option are thoroughly understood before proceeding.

Refer to figure 17 and proceed to the desired section for detailed instructions. Each submenu may be followed in the sequence shown or the [↑] and [↓] keys may be used to scroll through the prompts.

5.2 Reset totals

The TOTAL submenu permits the user to reset volumetric totals to zero and to reset the stopwatch totalizer. Press the appropriate side of the [SCREEN] key to activate the desired pane of the display screen, and complete the following steps:

1. To access the *clear menu*, press the [CLR] key.
 - a. If you have activated the security feature (see chapter 1, programming site data, for details), enter the assigned password and press [ENT].
2. Press [F1] = TOTAL.
3. Press [F1] to abort the procedure or press [F2] to clear all volumetric totals and reset the stopwatch totalizer. In either case, the initial clear menu prompt returns.

5.2.0a Procedure options

Do one of the following:

- Press [F1]-[F3] to enter one of the CLR submenus.
- Press the [EXIT] key to return to the data measurement display.

5.3 Deleting site files

Use the SITE submenu to clear site files from the GF868's memory. Use the [SCREEN] key to activate the desired display pane, and complete the following steps:

1. To access the *clear menu*, press the [CLR] key.
 - a. If you have activated the security feature (see chapter 1, programming site data, for details), enter the assigned password and press [ENT].
2. Press [F2] = SITE.
3. At the *site name* prompt, use the [←], [→] and [F1]-[F4] keys to select a site file for deletion. To leave the SITE submenu, press the [EXIT] key.

NOTE:

At the *site name* prompt, the option bar shows the names of all site files currently stored in memory.

4. Press [F1] to abort the procedure or press [F2] to *clear* the specified site file. If any site files remain in memory, the *site name* prompt repeats.

When all of the stored site files have been cleared or the [EXIT] key has been pressed at the SITE NAME prompt, the programming sequence resumes at this point.

5.3.0a Procedure options

Do one of the following:

- Press [F1]-[F3] to enter one of the CLR submenus.
- Press the [EXIT] key to return to the data measurement display.

5.4 Deleting log files

Use the LOG submenu to clear log files from the model GF868's memory. Press the appropriate side of the [SCREEN] key to activate the desired pane of the data display screen, and complete the following steps:

1. To access the *clear menu*, press the [CLR] key.
 - a. If you have activated the security feature (see chapter 1, programming site data, for details), enter the assigned password and press [ENT].
2. Press [F3] = LOG.
3. At the *name* prompt, the option bar shows the names of all log files currently stored in memory. Use the [←], [→] and [F1]-[F4] keys to select a log file for deletion. To leave the LOG submenu, press the [EXIT] key.
4. Press [F1] to abort the procedure or press [F2] to *clear* the specified log file. If any log files remain in memory, the *name* prompt repeats.

When all of the stored log files have been cleared or the [EXIT] key has been pressed at the name prompt, the programming sequence resumes at this point.

5.4.0a Procedure options

Do one of the following:

- Press [F1]-[F3] to enter one of the CLR submenus.
- Press the [EXIT] key to return to the data measurement display.

Chapter 6. Serial communications

6.1 Introduction

The model GF868 flowmeter is equipped with a standard RS232 serial interface. By using this interface, any log files stored in the GF868's memory may be easily uploaded to a personal computer. In order to accomplish this, the following steps must be completed:

- Connect the GF868 to the personal computer
- Check the GF868 baud rate setting
- Set up the personal computer's terminal software
- Transfer the log files to the personal computer.

6.2 Wiring the RS232 interface

The first step is to connect the built-in RS232 port in the GF868 to one of the serial ports (COM1 or COM2) on the personal computer. Table 21 lists the standard cables available from the factory for this purpose.

Table 21: Panametrics serial cables		
Part number	PC connector	GF868 connector
704-659	DB25 male	Flying leads (5)
704-660	DB9 male	Flying leads (5)
704-661	DB25 female	Flying leads (5)
704-662	DB9 female	Flying leads (5)

Each of the cables listed in table 21 is available in several standard lengths. However, a user-supplied cable may be used, if preferred. In either case, wire the GF868 end of the serial cable in accordance with the pin designations listed in table 22.

Table 22: RS232 pin connections			
GF868 pin #	Panametrics cable color	DB25 cable pin #	DB9 cable pin #
1 (RTN)	Green	7	5
2 (TX)	Black	3	2
3 (RX)	Red	2	3
4 (DTR)	White	20	4
5 (CTS)	Yellow	5	8

NOTE:

For serial communications between a single GF868 and a single personal computer, no connections are required to pins 4 and 5 of the GF868's serial connector.

However, these pins should be jumpered together to ensure proper operation.

6.3 Checking the GF868 baud rate

For successful serial communications, the GF868 and the personal computer must be set up to send/receive data at the same speed. To check the *baud rate* setting of the GF868, proceed as follows:

Access the *user program*, by pressing the [PROG] key on the keypad. The standard measurement mode screen is replaced by the following initial programming mode screen:

PROGRAM Start ▶

PROGRAM

previous selection appears here

CH1 | CH2 | GLOBL | SAVE

Press the [F3] key to select the GLOBL menu.

PROGRAM Start ▶

Global PROGRAM

previous selection appears here

CLOCK | SYSTM | I/O | COMM

Press the [F4] key to select the COMM submenu.

Global COMM PROGRAM ▶

Global PROGRAM

Comm port

BAUD RATE

current setting appears here

4800 | 9600 | 19200

To change the baud rate, press the [→] key until the desired baud rate appears on the option bar, and then press the appropriate [Fx] function key.

The available rates are 300, 600, 1200, 2400, 4800, 9600 and 19200 baud. After verifying or changing the baud rate setting, press the [EXIT] key three times to return to standard measurement mode.

NOTE:

Refer to chapter 1, programming site data, for a detailed description of using the COMM submenu.

6.4 Setting up the terminal software

Specific instructions are given in this manual for communicating with personal computers running under either the Windows 3.X or Windows 9X/NT operating systems. Proceed to the appropriate section for detailed set up procedures.

NOTE:

For computers operating under other operating systems, contact the factory for assistance or consult the operating system manual supplied with the computer.

6.4.1 Windows 3.X systems

To set up serial communications with a personal computer running under Windows 3.X, make sure the GF868 is powered on and complete the following steps:

1. In Windows 3.X, select the terminal function, which is usually located in the Accessories window.
2. The terminal screen appears, with six menus located at the top of the screen. Using the settings menu, select the communications option.
3. When the communications screen appears, make the following selections:
 - **Baud rate** – set to the same value as the GF868 setting
 - **Data bits** – 8
 - **Stop bits** – 1
 - **Parity** – None
 - **Flow control** – Xon/Xoff
 - **Connector** – select the correct communications port
 - **Parity check** – **not** checked
 - Carrier detect – **not** checked
4. Using the transfer menu, select the receive text file option.
5. A window appears asking for a file name. Select the desired directory and file name (with .prt extension) and then click on OK.
6. From the keypad on the GF868, enter the PRINT menu and select the log file to be up-loaded to the computer in numeric format. See chapter 4, *printing data*, for detailed instructions on this procedure.
7. The logged data will begin appearing on the computer screen. After the transfer has been completed, the uploaded file may be used in any software program, just like any other text file.

NOTE:

If the RS232 link does not function, switching the leads to pins 2 (TX) and 3 (RX) at the RS232 connector on the meter often solves the problem

6.4.2 Windows 9X/NT systems

Windows 9X/NT systems use a program called *hyperterminal* to access the serial ports. To set up serial communications with a personal computer running under Windows 95, Windows 98 or Windows NT, make sure the GF868 is powered on and complete the following steps:

1. From the Windows START menu, select PROGRAMS>ACCESSORIES>HYPERTERMINAL>HYPERTERMINAL.
2. The NEW CONNECTION window should appear (if it does not, select it from the FILE menu). After entering the desired CONNECTION NAME and selecting an ICON, click on OK.
3. When the CONNECT TO window appears, select the serial communications port (COM1 or COM2) to which the GF868 is connected and click on OK.
4. When the COMx PROPERTIES window appears, make sure the settings are as follows:
 - Bits per second: 9600 (must match the GF868 setting)
 - Data bits: 8
 - Parity: none
 - Stop bits: 1
 - Flow control: Xon/XoffAfter making any necessary changes, click on OK.
5. Open the TRANSFER menu and select CAPTURE TEXT. Enter the desired DRIVE:\DIRECTORY\FILENAME for the file about to be transmitted, and click on OK.
6. From the keypad on the GF868, enter the PRINT menu and select the log file to be uploaded to the computer in numeric format. See chapter 4, *printing data*, for detailed instructions on this procedure.
7. The logged data will begin appearing on the computer screen. When the transfer has been completed, open the TRANSFER menu and select CAPTURE TEXT>STOP. The uploaded file may now be used in any software program, just like any other text file.

NOTE:

If the RS232 link does not function, switching the leads to pins 2 (TX) and 3 (RX) at the RS232 connector on the meter often solves the problem.

6.5 The optional RS485 serial interface

Although the standard RS232 serial interface included with the model GF868 is adequate for most applications, Panametrics offers an optional RS485 serial interface upgrade for special situations. The model GF868 is easily modified to provide RS485 communications, and this section describes the wiring and use of the special RS232 to RS485 converter.

NOTE:

For compliance with the European union's low voltage directive, this unit requires an external power disconnect device such as a switch or circuit breaker. The disconnect device must be marked as such, clearly visible, directly accessible, and located within 1.8 m (6 ft) of the electronics console.

6.5.1 Interface converter mounting

A special bracket containing the serial interface converter and a three-terminal barrier strip is mounted inside the model GF868, just below the RS232 terminal block (see figure 9). The standard RS232 terminal block is wired to the input of the serial interface converter, and the RS-485 output of the serial interface converter is wired to the barrier strip.

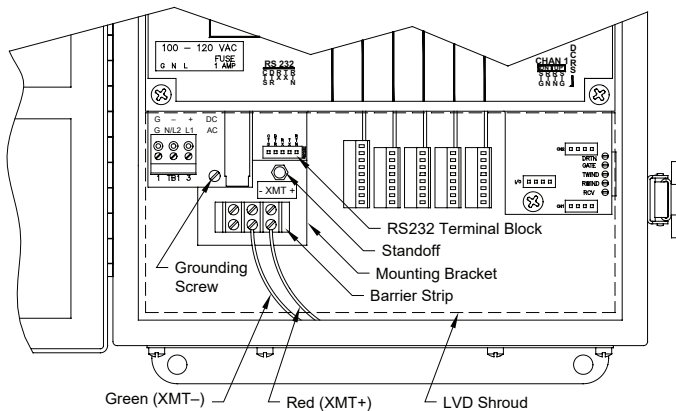

Figure 9: Interface converter mounting

6.5.2 Point-to-point wiring

Standard factory wiring of the RS485 serial interface is configured for point-to-point wiring. That is, a single model GF868 may be wired directly to a single personal computer. To connect the RS485 serial interface, refer to figure 9 and complete the following steps:

NOTE:

For compliance with the European union's low voltage directive, a transparent plastic shroud protects the electrical connections. The shroud must remain in place, except while wiring the unit. Reinstall the shroud after the wiring has been completed.

1. Disconnect the main power to the electronics console and open the cover.



WARNING!

Dangerous voltages exist within the electronics console. Do not perform any wiring operations until the main power to the unit has been disconnected.

2. Remove the clear plastic shroud that covers the electrical connectors.
3. Using a *twisted-wire pair*, connect the XMT+ terminal of the barrier strip to the T+/R+ terminal of the PC's RS485 adapter and connect the XMT- terminal of the barrier strip to the T-/R- terminal of the PC's RS485 adapter (see the documentation provided with the RS485 adapter for details).

NOTE:

The XMT+ terminal on the barrier strip is the screw opposite the red wire connection and the XMT- terminal on the barrier strip is the screw opposite the green wire connection.

4. Reinstall the clear plastic shroud, close the cover to the electronics console and reconnect the main power.

The RS485 serial interface is now ready for point-to-point operation. However, the installed version of the model GF868 software must be *version 3G* or higher to support RS485 operation. If necessary, contact the factory for information about a software upgrade.

6.5.3 Multi-point wiring

The standard point-to-point wiring configuration for the serial interface converter may be modified to permit the use of a multi-point wiring arrangement. In a multi-point RS485 system, one flowmeter (the master) is connected to the personal computer, while a number of additional flowmeters (the slaves) are chained together and connected to the master flow-meter. In order to implement such a system, the DIP switch settings inside each serial interface converter must be changed.

IMPORTANT:

The serial interface converter in the **last** slave unit in the chain should not be reconfigured.

6.5.3a Reconfiguring a serial interface converter

To reconfigure a serial interface converter for multi-point wiring, complete the following steps:

1. Disconnect the main power to the electronics console and open the cover.

	<p>WARNING!</p> <p>Dangerous voltages exist within the electronics console. Do not perform any wiring operations until the main power to the unit has been disconnected.</p>
---	---

2. Remove the clear plastic *shroud* that covers the electrical connectors.
3. Remove the serial interface converter *mounting bracket* by removing the standoff located just below the RS232 terminal block and the grounding screw just to its left (see figure 9).
4. Loosen the two screws that fasten the DB9 connector to the mounting bracket, and remove the *serial interface converter* from the bracket.
5. Use a small screwdriver to pry open the *plastic case* of the serial interface converter, as shown in figure 10.

The serial interface converter contains a main printed circuit board and a daughter printed circuit board. The daughter board has a small terminal block attached to it and the main board has a DIP switch (SW1) mounted near the center of the board.

6. Locate the switch assembly on the main board, and move the switch in position 1 from ON to OFF. The standard ON state for this switch is for point-to-point operation, while the OFF state is needed for multi-point operation. See table 23 for the proper settings of all four switches on the switch assembly.

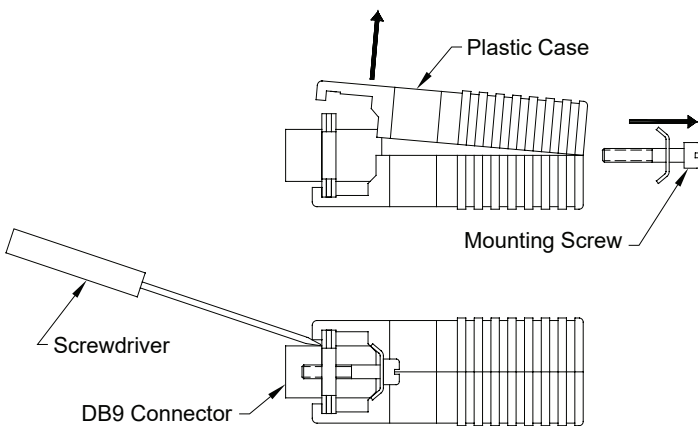

Figure 10: Opening the converter case

Table 23: Switch Assembly settings

Position #	Point-to-point	Multi-point
1	ON	OFF
2	ON	ON
3	ON	ON
4	OFF	OFF

1. Reassemble the serial interface converter and secure it to the mounting bracket with the two mounting screws.
2. Reinstall the mounting bracket into the electronics enclosure and secure it with the standoff and the grounding screw.

6.5.3b Wiring the system

After the serial interface converters have been configured for multi-point operation, the system can be wired.

1. Using *twisted-wire pairs*, connect the XMT+ terminals of all the flowmeters together and connect the XMT- terminals of all the flowmeters together.

IMPORTANT:

Make sure that the flowmeter with the non-modified converter is wired as the last unit in the chain.

2. Using a twisted-wire pair, connect the XMT+ terminal of the barrier strip to the T+/R+ terminal of the PC's RS485 adapter and connect the XMT- terminal of the barrier strip to the T-/R- terminal of the PC's RS485 adapter (see the documentation provided with the RS485 adapter for details).

NOTE:

The XMT+ terminal on the barrier strip is the screw opposite the red wire connection and the XMT- terminal on the barrier strip is the screw opposite the green wire connection.

3. Reinstall the clear plastic shroud, close the cover to the electronics console and reconnect the main power. The RS485 serial interface is now ready for multi-point operation.

IMPORTANT:

The installed version of the model GF868 software must be version 3G or higher to support RS485 operation. If necessary, contact the factory for information about a software upgrade.

6.6 Setting up an Ethernet connection

A modified GF868 can use the Ethernet interface to communicate with an internal network. An optional Ethernet card with a unique MAC (IP) address (installed only in slots 5 or 6) includes an RJ45 connector. To connect the Ethernet-enabled GF868 to the network, insert the jack of an RJ45 cable into the RJ45 connector, route the cable through the bottom of the GF868, and wire the other end of the cable to the LAN according to the manufacturer's instructions.

To establish Ethernet communications with the GF868, you must install the Ethernet device discovery software utility (available with your modified GF868) on a PC connected to the LAN. Once installed and running, the software displays all Ethernet devices currently connected to the subnet. You can identify the GF868 by its MAC address, supplied as part of customer documentation. The default IP port is 2101.

The default IP addressing for the GF868 is DHCP (dynamic). If you need to assign a static IP address to the GF868, complete the following steps:

IMPORTANT:

To assign a static IP address, the GF868 must be connected to an Ethernet network with a dynamic address assignment mechanism (DHCP) first.

1. Run Ethernet device discovery software, and identify the GF868's current IP address.
2. Open your internet browser (Internet Explorer, Netscape, or other) and type the GF868 IP address in the address box.
3. The connect ME configuration and management window opens. Two text boxes ask for the user name and password.
 - a. In the username text box, type root.
 - b. In the password text box, type dbps.
4. At the left of the window, click on network.
5. The IP settings window opens. In the text boxes for IP address, subnet mask, and default gateway, type in the new information.
6. Click apply. The software applies the new address.

6.7 Setting up a MODBUS/TCP connection

A modified GF868 can use the MODBUS/TCP interface to communicate with an internal network. An optional MODBUS/TCP card with a unique MAC (IP) address (installed only in slots 5 or 6) includes an RJ45 connector. To connect the MODBUS/TCP-enabled GF868 to the network, insert the jack of an RJ45 cable into the RJ45 connector, route the cable through the bottom of the GF868, and wire the other end of the cable to the LAN according to the manufacturer's instructions.

To establish MODBUS/TCP communications with the GF868, you must install the ruiping software utility (available with your modified GF868) on a PC connected to the LAN. Once installed and running, the software displays all Ethernet devices currently connected to the subnet. You can identify the GF868 by its MAC address, supplied as part of customer documentation. The default TCP port is 502.

The default IP addressing for the GF868 is DHCP (dynamic). If you need to assign a static IP address to the GF868, complete the following steps:

IMPORTANT:

To assign a static IP address, the GF868 must be connected to an Ethernet network with a dynamic address assignment mechanism (DHCP) first.

1. Run ruiping software, and identify the GF868's current IP address.

NOTE:

"Ruiping" will return the found IP address as well as the MAC address.

2. From a DOS command prompt, type: telnet "ip address" 10000
3. The "Welcome to Net+Works configuration Utility" opens. Type in the login name and password.
 - a. Login: type root.
 - b. Password: type Netsilicon.
4. In the main menu:
 - a. Select IP parameters (1). Enter the desired IP changes and return to the main menu.
 - b. Select Enable DHCP Client (3). Select N (2) to disable, then select 4 for main menu.
 - c. At the main menu, select 4 for quit. Power cycle the GF868 (i.e., turn the meter off and on) to apply the changes.

Appendix A. Menu maps

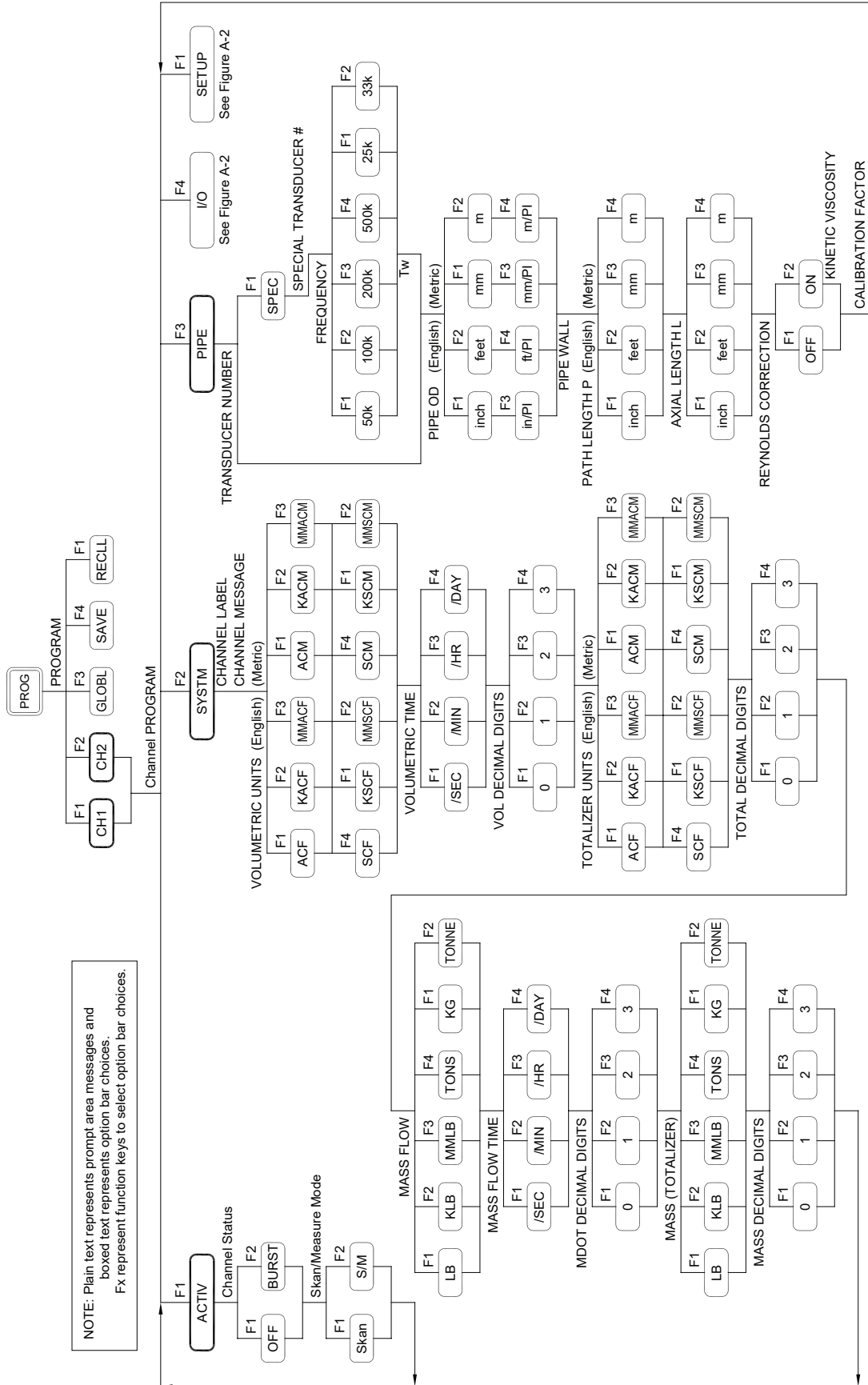

Figure 11: ACTIV, SYSTM and PIPE menu map

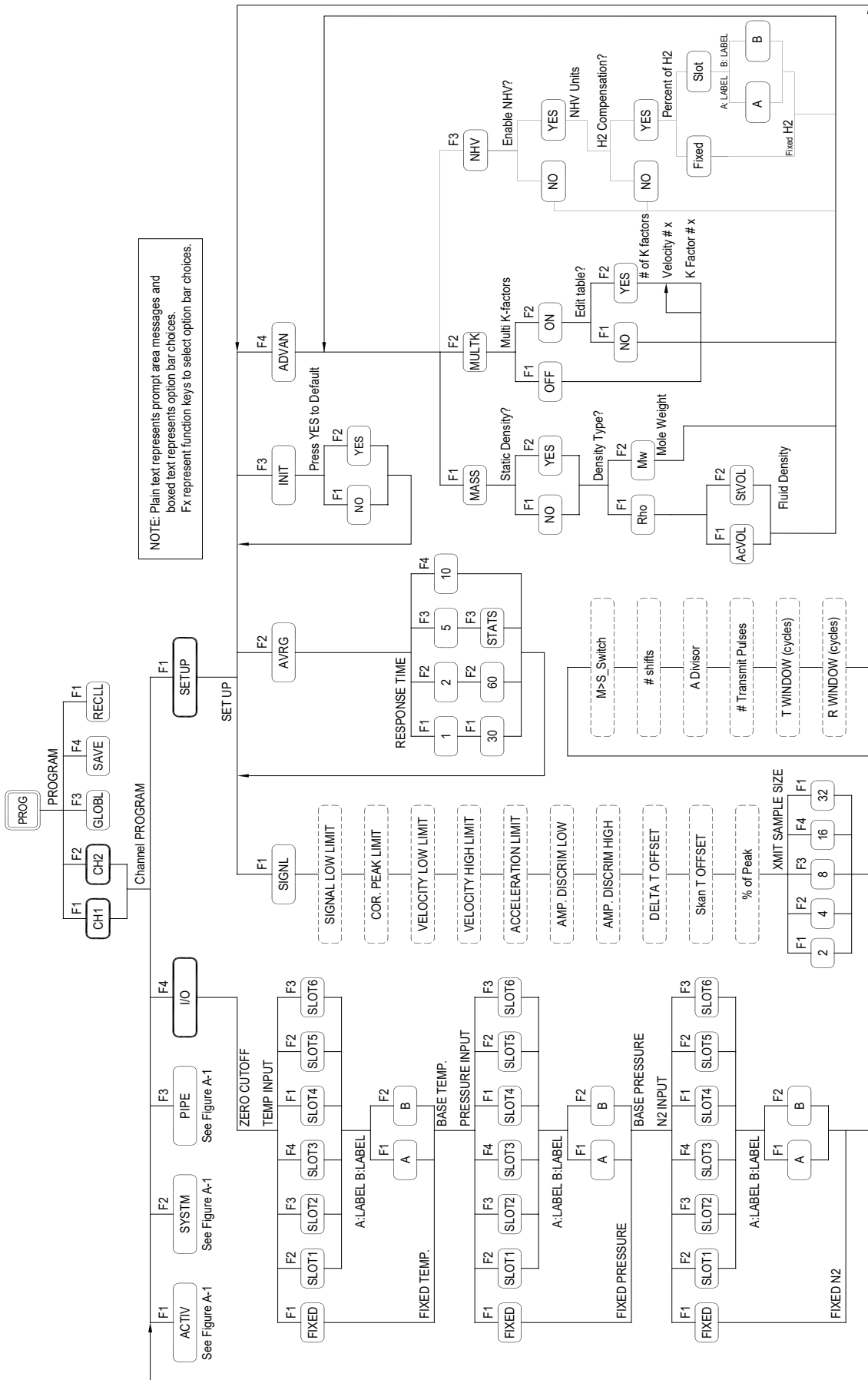

Figure 12: CH1/CH2 - I/O and setup menu map

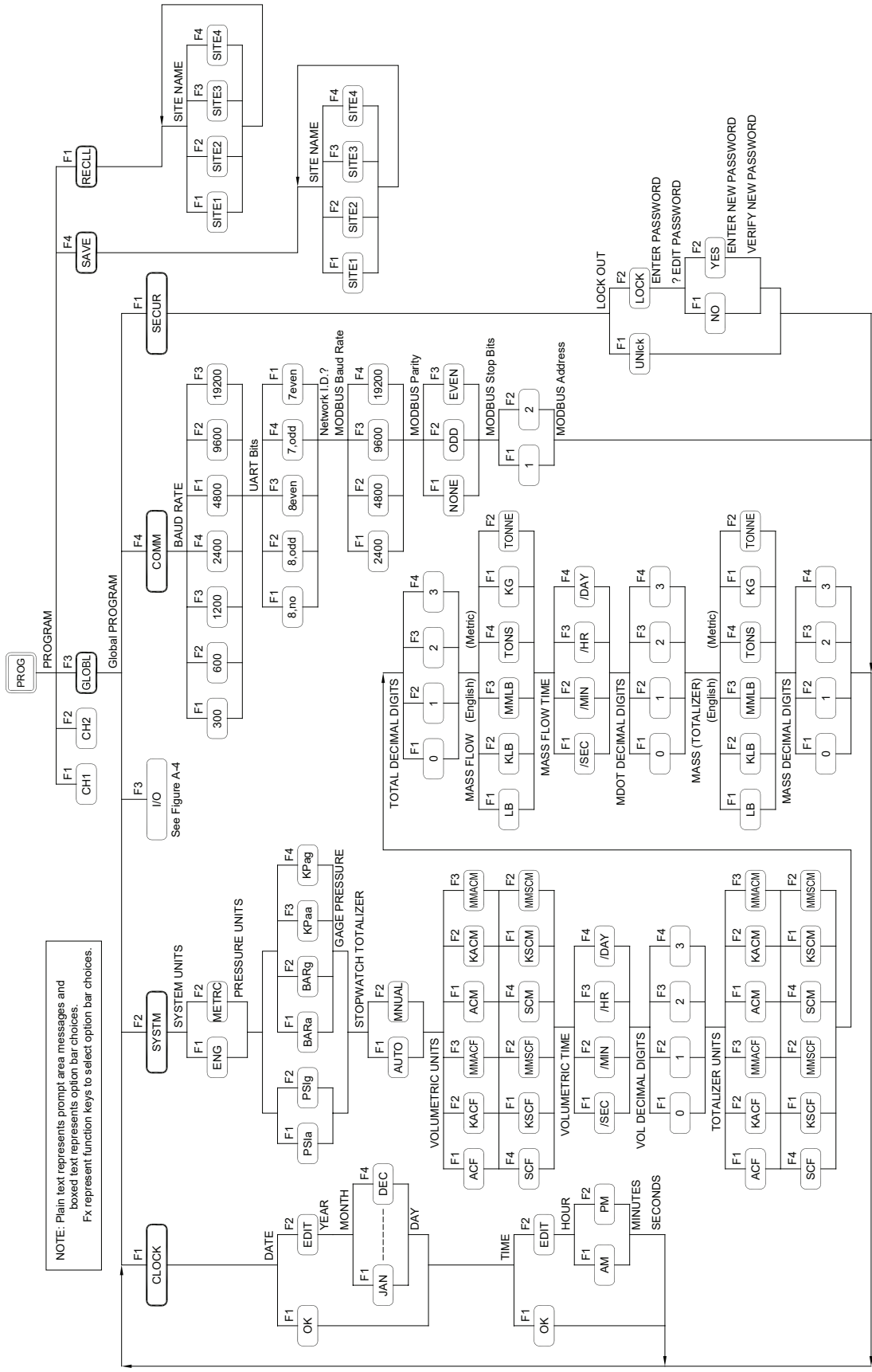

Figure 13: GLOBL (except I/O), SAVE and RECLL menu map

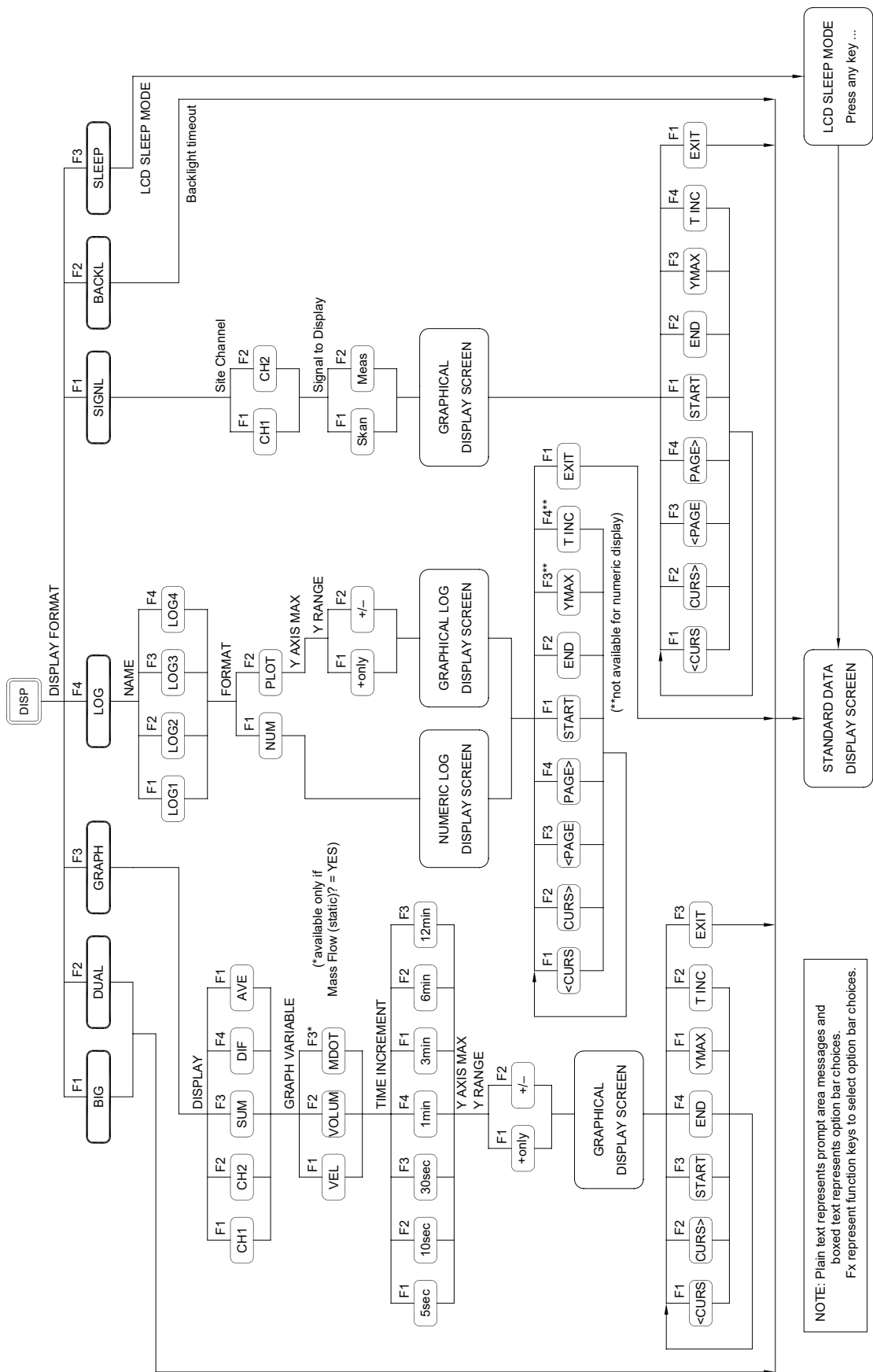

Figure 15: DISP menu map

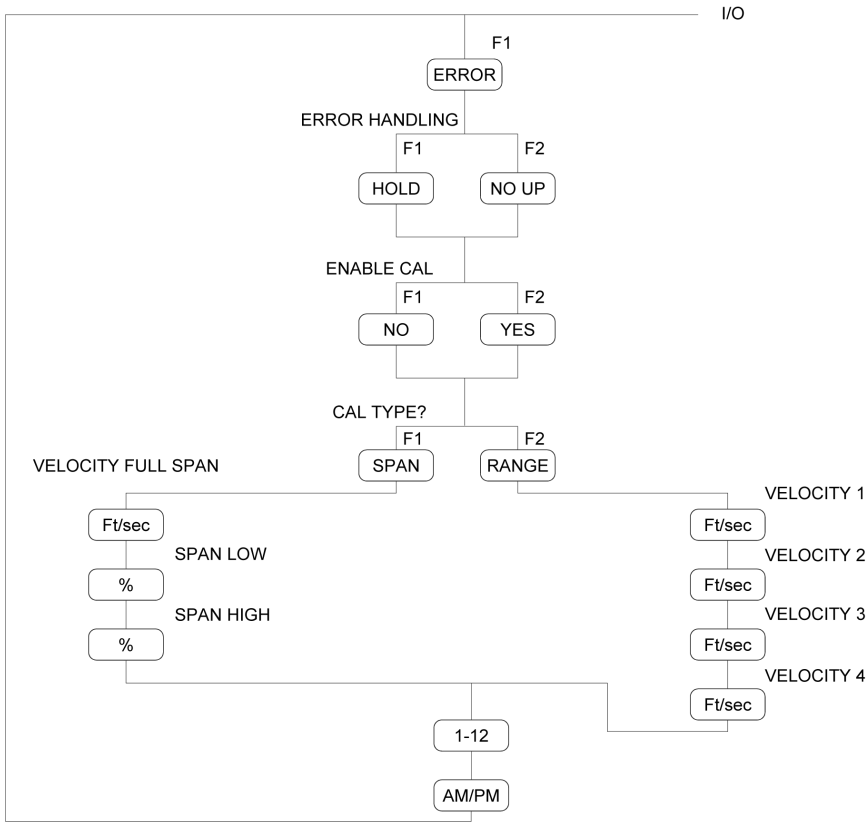

Figure 17

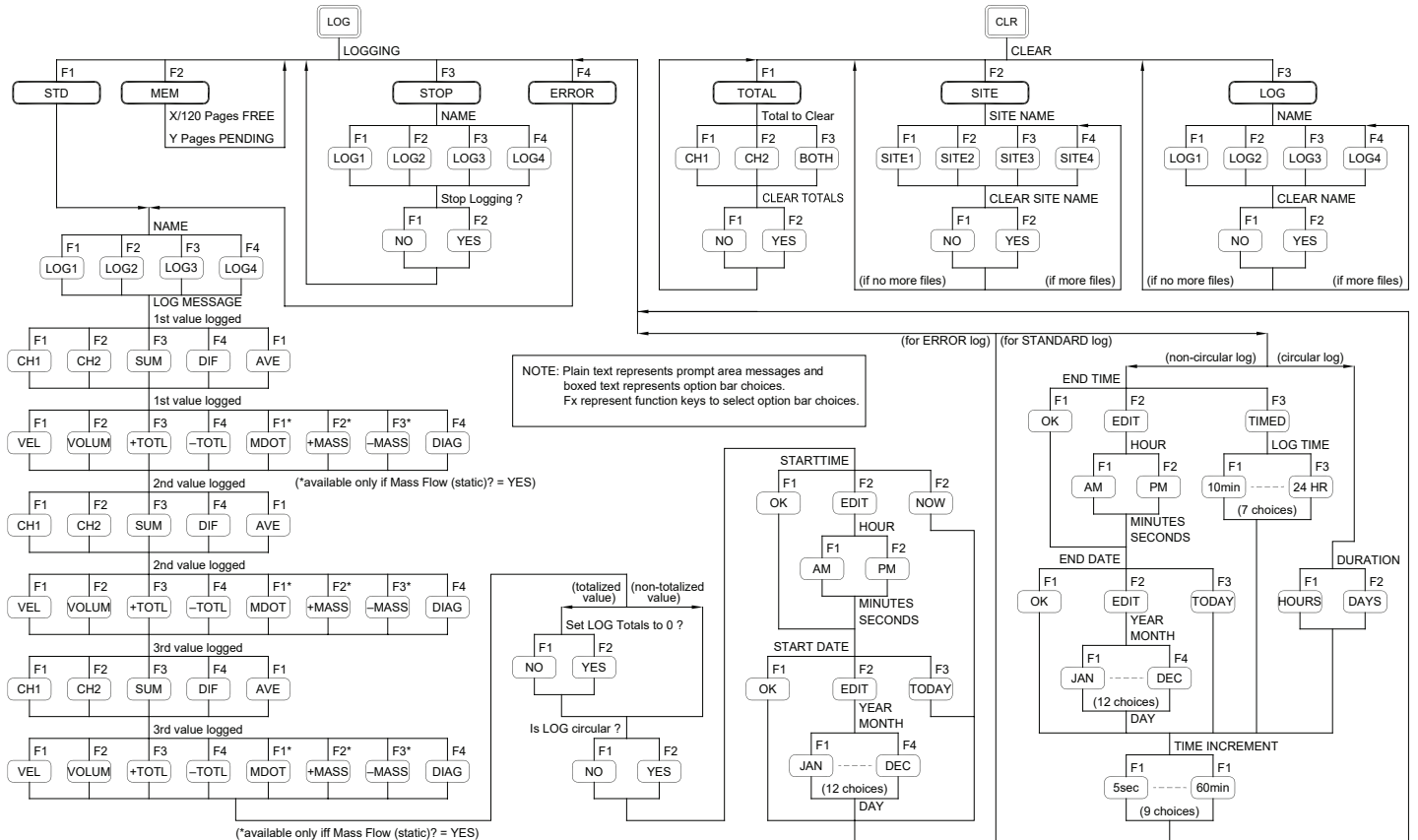

Figure 18: LOG and CLR menu maps

Appendix B. Data records

B.1 Option cards installed

Whenever an option card is installed in one of the model GF868's expansion slots, record the type of card and any additional setup information in the appropriate row of table 24.

Table 24: Option cards installed		
Slot #	Type of option card	Additional setup information
0	Analog outputs (A, B)	
1		
2		
3		
4		
5		
6		

B.2 Initial setup data

After the model GF868 flowmeter has been installed, some initial setup data must be entered via the user program, prior to operation. Record that information in table 25.

Table 25: Initial setup data					
General information					
Model #			Reference		
Software vers.			Date		
serial #			Z dimension		
Measurement method (CH1/CH2-ACTIV)					
Channel 1			Channel 2		
Channel status	Off	Burst	Channel status	Off	Burst
Measure mode	Skon	S/M	Measure mode	Skon	S/M
Channel parameters (CH1/CH2-SYSTEM)					
Channel 1			Channel 2		
Channel label			Channel label		
Channel message			Channel message		
Gas equation	Standard	Actual	Gas equation	Standard	Actual
Vol. units			Vol. units		
Vol. time units			Vol. time units		
Vol. dec. digits			Vol. dec. digits		
Totalizer units			Totalizer units		
Tot. dec. digits			Tot. dec. digits		
Mass flow			Mass flow		
Mass flow time			Mass flow time		
MDOT dec. dig.			MDOT dec. dig.		
Mass (TOT.)			Mass (TOT.)		
Mass dec. dig.			Mass dec. dig.		
System parameters (GLOBL)					
System units	English	Metric	MDOT dec. dig.		
Pressure units			Mass (TOT.)		
Stopwatch total.	Auto	Manual	Mass dec. dig.		
Vol. units			COMM submenu		
Vol. time units			Password		
Vol. dec. digits			Baud rate		
Totalizer units			UART Bits		
Tot. dec. digits			Network ID		
ERROR submenu			MODBUS baud rate		
Error Handling			MODBUS parity		
2-path high	NO	YES	MODBUS stop bits		
Mass flow			MODBUS Address		
Mass flow time					

Table 25: Initial setup data

Pipe/transducer parameters (CH1/CH2-PIPE)

Channel 1			Channel 2		
Trans. #			Trans. #		
Spec. trans. Hz			Spec. trans. Hz		
Spec. trans. Tw			Spec. trans. Tw		
Pipe O.D.			Pipe O.D.		
Pipe wall			Pipe wall		
Path length (P)			Path length (P)		
Axial length (L)			Axial length (L)		
Fluid type	Air	Other	Fluid type	Air	Other
Other/sndspd			Other/sndspd		
Reynolds corr.	Off	On	Reynolds corr.	Off	On
Kin. visc.			Kin. visc.		
Cal. factor			Cal. factor		

Advanced features (CH1/CH2-SETUP-ADVAN)

Static density	No	Yes	Static density	No	Yes
Rho/Mw			Rho/Mw		
Multi K factors	No	Yes	Multi K factors	No	Yes
K factor table			K factor table		
K-factor #	Velocity	K-factor	K factor #	Velocity	K-factor
1			1		
2			2		
3			3		
4			4		
5			5		
6			6		
7			7		
8			8		
9			9		
10			10		
11			11		
12			12		
13			13		
14			14		
15			15		
16			16		
17			17		
18			18		
19			19		
20			20		

Appendix C.

Programming with PanaView

C.1 Introduction

The PanaView™ graphical user interface offers interactive communications between Windows-based PCs and Panametrics instruments compatible with the company's IDM protocol, such as the GF868 ultrasonic gas flowmeter. PanaView is compatible with 32-bit Windows operating systems such as Windows 98SE, NT 4.0 (with service pack 6), 2000, XP and ME. With PanaView, you can:

- load and save site file data
- create and save graph and log files
- display text output and graphs of live measurement data
- create custom templates for displaying text, graph and log data
- interface with multiple Panametrics instruments.

This document focuses on particular applications suitable for the GF868. For general PanaView applications such as creating graph and log files, displaying live measurement data, and creating custom templates, please refer to the general PanaView *user's manual* (910-211).

C.2 Wiring the RS232 interface

All IDM-protocol instruments utilize an RS232 interface to communicate with a PC. For details on wiring your RS232 interface, please refer to the Installation chapter of your instrument's User's manual, and to the document *EIA-RS serial communications* (916-054).

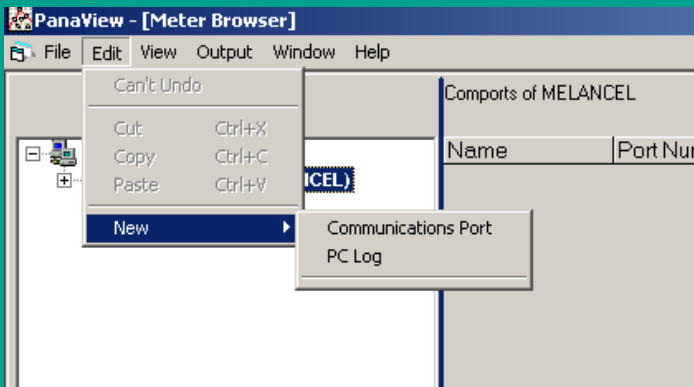

Figure 18: Edit menu

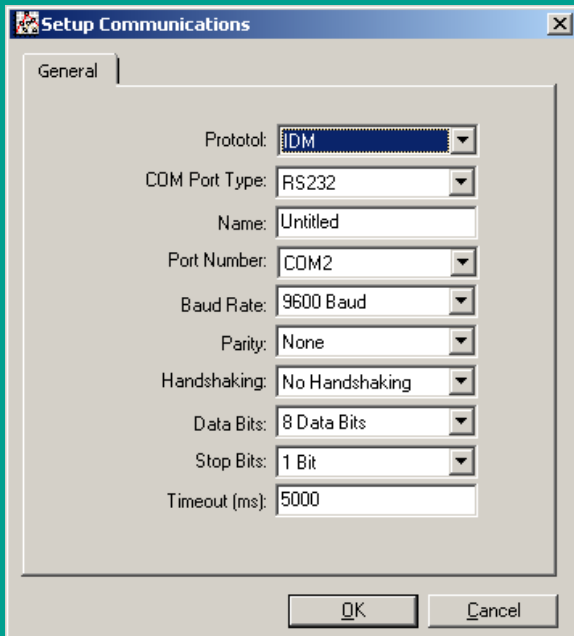

Figure 19: Setup communications screen

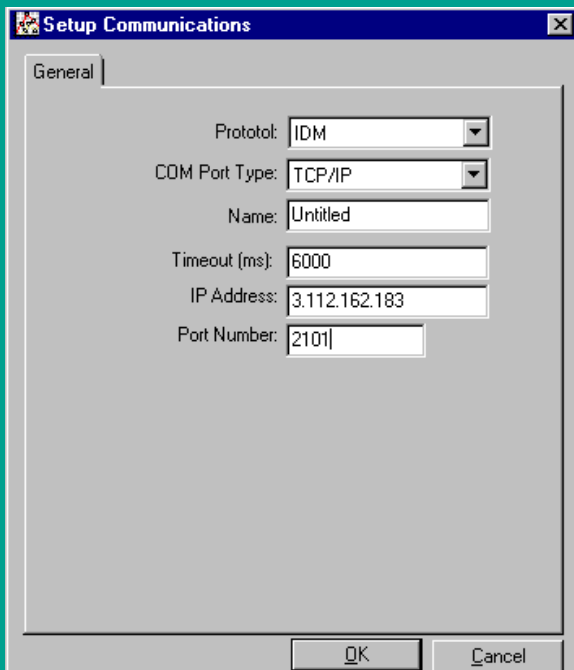

Figure 20: Setup communications for TCP/IP

C.3 Setting up the communications port

Use the steps below to establish communications with the GF868.

1. Open the “new meter browser” window and expand the network tree. Then, highlight the *my computer(name)* branch by clicking on it.
2. Pull down the “edit” menu by clicking on it in the menu bar.
3. Click on the “new” menu option to select it, and a submenu opens with two choices on it (see figure 18).
4. Click on the “communications port” option to select it. The setup communications screen appears similar to figure 19.
5. Open the protocol menu (the first of the drop-down menus) and click on IDM.
6. Open the COM port type menu and click on the desired type (or on TCP/IP, if the GF868 is using an Ethernet connection).

NOTE:

If you select TCP/IP, the menu changes. See C.3.1 Setting up Ethernet communications.

7. Select any suitable available baud rate. A baud rate of 19,200 is appropriate for almost all applications. However, if you experience periodic communication reliability problems, you may wish to consider lowering the baud rate on your instrument and in PanaView.

IMPORTANT:

Be sure all the communications port settings match those made in setting up the meter’s serial port.

8. Click [OK] to complete data entry.

C.3.1 Setting up Ethernet communications

If you have selected TCP/IP in step 6, the setup communications window appears similar to figure 20.

1. Type in the desired *name* and *timeout* (in milliseconds).
2. In the *IP address* text box, enter the IP address. If the IP address is unknown, run the device discovery software utility. All units found will be identified by their MAC address and the assigned IP address. In the *port number* box, enter 2101 (the default value).
3. Click [OK] to complete data entry.

IMPORTANT:

If you are using Ethernet communications, be sure the GF868 is set up with the default communications parameters: 9600 baud, no parity, no handshaking, 8 data bits and 1 stop bit. The port number must match the “Enable raw TCP access using TCP port” assignment shown under the device discovery “TCP server settings” menu (configuration>serial ports>port).

C.4 Adding the GF868

To add the GF868 on the IDM-configured communications port, complete the following steps:

1. Highlight the communication port to which the meter will be added by clicking on it, and then open the “edit” menu on the menu bar (if the communication port is not highlighted first, the “new meter” option is not active in the “edit” menu).
2. Click on the “new” option in the “edit” menu (see figure 21).
3. After clicking on the “new” option, the “meter” menu option appears. Click on this option to select it.
4. The “new IDM meter” screen (shown in figure 22) opens. Enter the network ID number for the meter, and click [OK].

IMPORTANT:

The Network ID number must match the Network ID programmed in the meter’s communications menu.

If the initialization is successful, the meter browser shows a listing similar to figure 23.

NOTE:

The model number and version that appear will vary with your particular meter and software version.

However, if the settings do not match, or there is some other difficulty, a screen appears similar to figure 24.

The screen offers the options of trying again or of canceling the operation. Click on the desired choice, and then on [OK] to confirm the choice or on [exit Application] to close PanaView.

NOTE:

If you cannot resolve the problem, contact the factory for help.

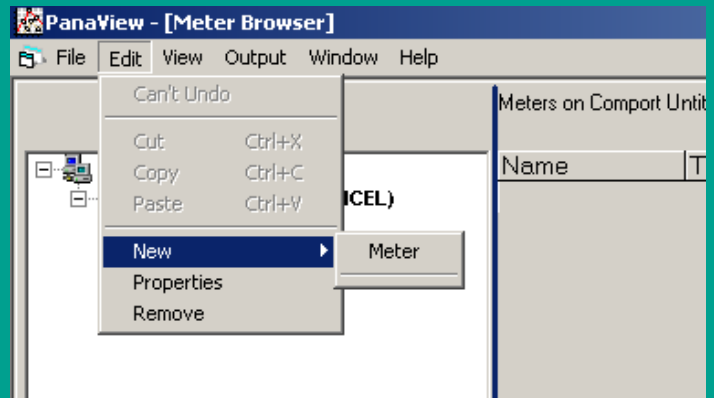

Figure 21: “New” option in the “edit” menu

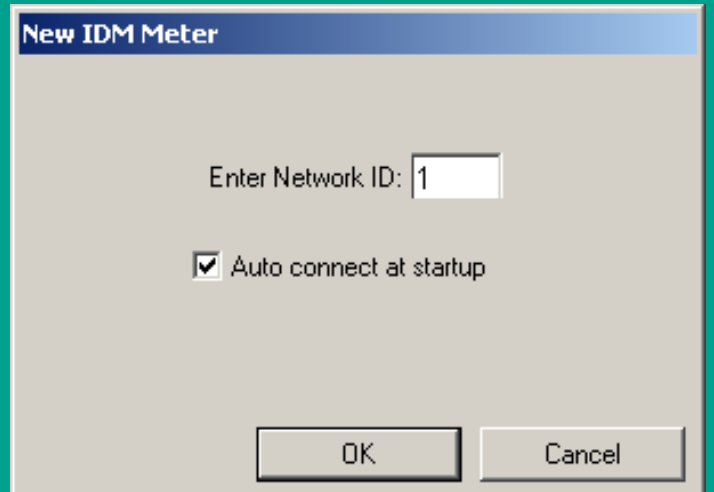

Figure 22: New IDM meter screen

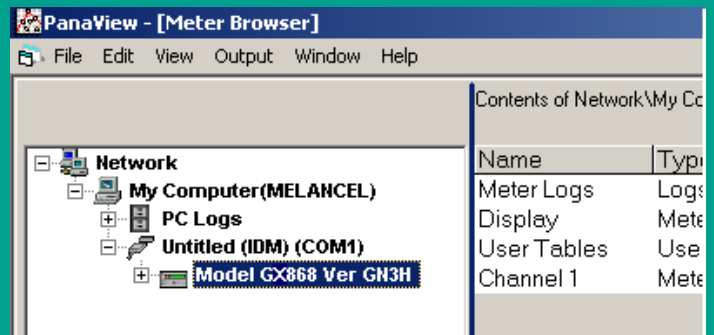

Figure 23: Updated network tree

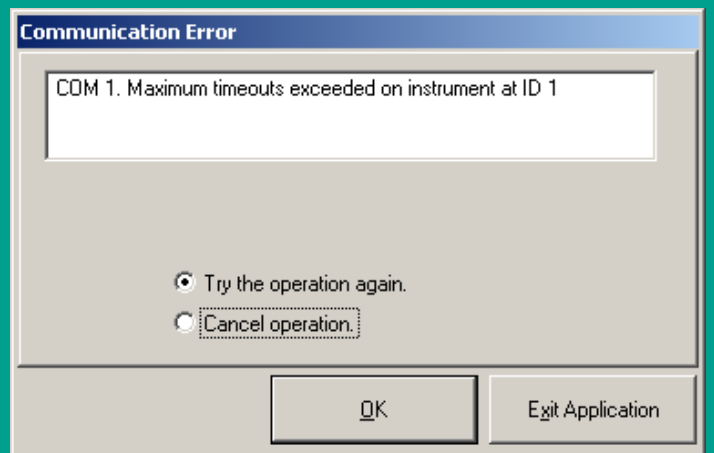

Figure 24: Communication error screen

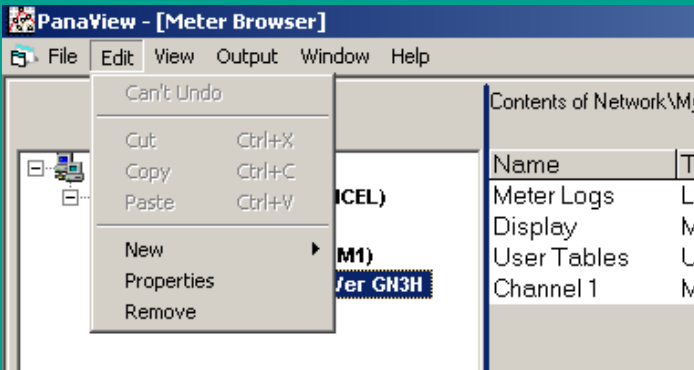

Figure 25: Properties option in the edit menu

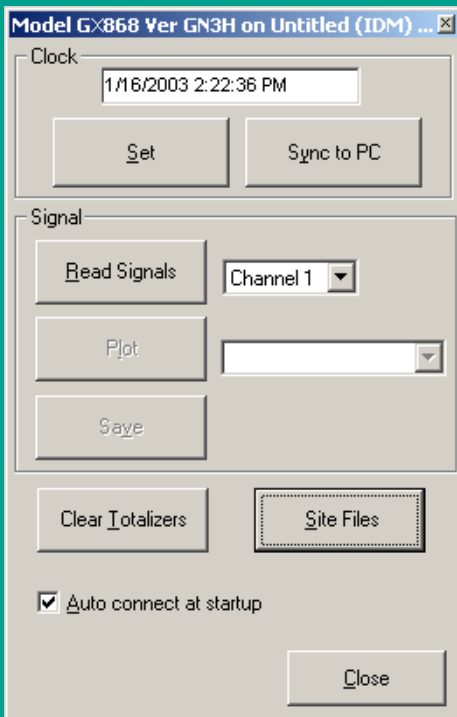

Figure 26: Properties window for IDM-based meter



Figure 27: Time and date selection window

C.5 Editing meter properties

Through PanaView, you can edit the properties of your GF868. You can:

- Set the meter clock, or synchronize it with the PC clock
- Read, plot and save transducer signals
- Clear totalizers
- Save site files to the meter or PC
- Clear sites from the meter
- Print site files to the PC

To edit the properties of your GF868:

1. Highlight the meter (as shown in figure 23).
2. Open the "edit" menu and select the "properties" option, as shown in figure 25.

The window appears similar to figure 26. To perform a specific task, refer to the appropriate section.

- Setting the meter clock
- Reading transducer signals
- Plotting transducer signals
- Saving transducer signals
- Clearing totalizers
- Handling site files

NOTE:

For illustration purposes, the meter shown here is a one-channel GX868 flowmeter. Specific parameters will vary with your particular meter.

C.5.1 Setting the meter clock

The meter's time may be reset in three different ways:

- Manually enter the time and date in the text box, or
- Click on the [sync to PC] option button to have PanaView set the time and date to the current PC setting, or
- Click on the [set] option button to open the dialog box shown in figure 27. Set the desired date and time as indicated, and click on the [OK] option button.

C.5.2 Reading transducer signals

To read a signal from the meter:

1. Click on the *read signals* button. (If the meter is a multi-channel instrument, open the channel drop-down menu and click on the desired channel.) After a moment, the *properties* window appears similar to figure 28.
2. To select a different signal type, open the signal menu at the right (shown here with *raw up-stream* highlighted) and click on the desired signal.

C.5.3 Plotting transducer signals

To plot the selected signal, click on *plot*. A graphical window opens, as shown in figure 29.

C.5.4 Saving transducer signals

To save the raw signal, click *save*. A window opens similar to figure 30. Enter the desired name, and click *save* to save the signal as a text file.

C.5.5 Clearing totalizers

To clear the meter totalizers, click on the *clear totalizers* button in the properties window. The meter totalizers are reset to 0.

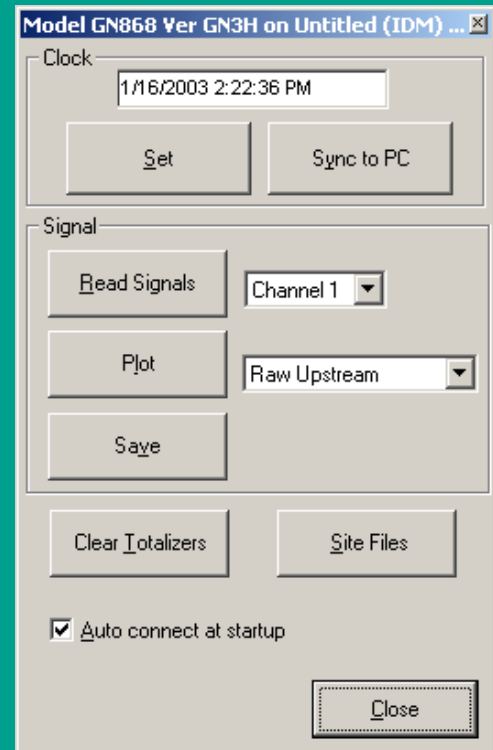

Figure 28: Active signal options in properties window

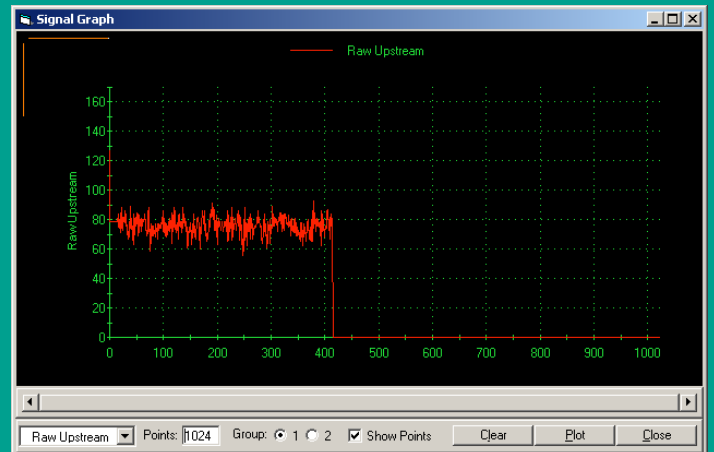

Figure 29: signal graph window

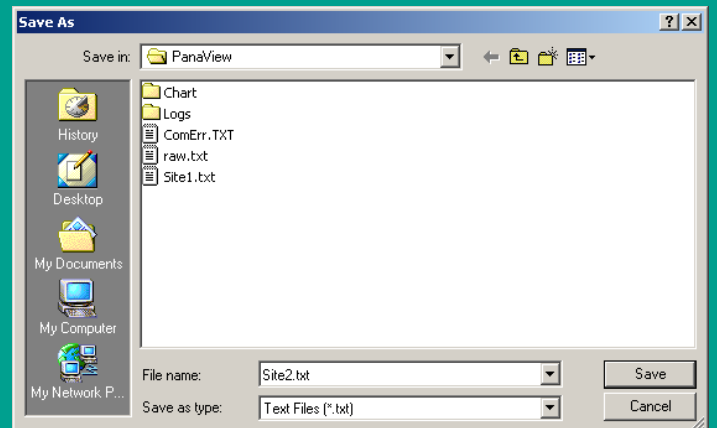

Figure 30: Save as window

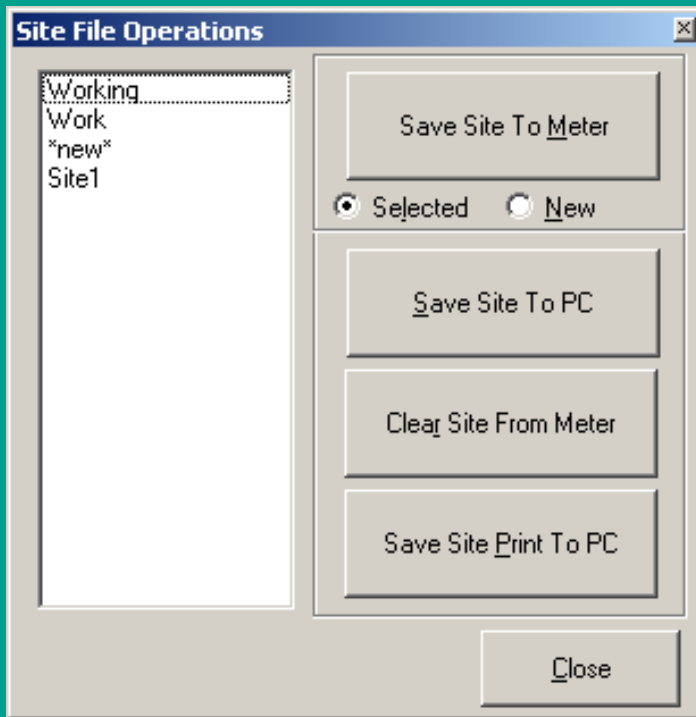

Figure 31: Site file operations window

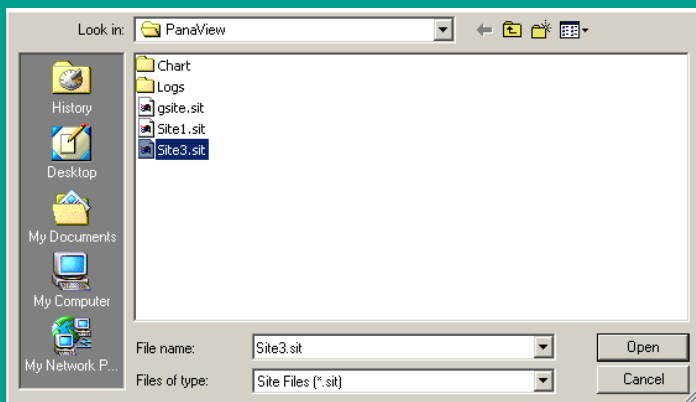

Figure 32: Site file selection

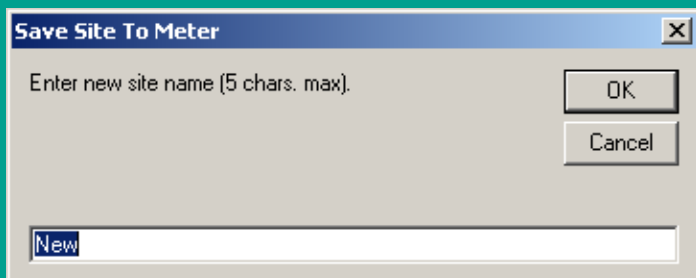

Figure 33: Site name entry window

C.5.6 Handling site files

To access site files, click on the *site files* button in the *properties* window. The site file operations window (shown in figure 31) opens.

C.5.6a Saving an existing site to the meter

To save an existing site to the meter:

1. Select the radio button for *selected* and highlight an existing site in the left pane.
2. Then click on the *save site to meter* button. A screen opens similar to figure 32.
3. Highlight the desired site and click *open*. PanaView sends the site to the meter.

C.5.6b Saving a New site to the meter

To save a new site to the meter:

1. Select the radio button for *new* and click on the *save site to meter* button.
2. A window opens similar to figure 33. Enter the desired name, and click [OK].
3. The *site file selection* window (figure 32) opens. Highlight a site with the desired settings, and click [open]. PanaView saves the site in the meter with the new name and the desired settings.

C.5.6c Saving a site to the PC

To save a site to the PC:

1. Highlight the desired site in the left pane. (see figure 31.)
2. Click *save site to PC*. A window opens similar to figure 30.
3. Enter the desired site name and click [save]. PanaView saves the site in the PanaView folder unless otherwise specified.

NOTE:

If you have created a site on the meter after opening the site file operations window, you must close and reopen the window to click on the new site.

C.5.6d Clearing a site from the meter

To clear a site from the meter:

1. Highlight the site in the left pane. (see figure 31.)
2. Click *clear site from meter*.
3. The program asks for confirmation. Click [OK].
The meter deletes the designated file.

C.5.6e Saving a site in text form

To store the data from a site file as a text file for display or printout:

1. Highlight the site in the left pane. (see figure 31.)
2. Click *save site print to PC*.
3. The *site file selection* window opens (refer to figure 32).
Enter the desired site name (now with a .prt suffix) and click [save]. PanaView displays a text version of the site, as shown in figure 34.
4. Click [close] once to close the *site file operations* window, and a second time to close the properties window and return to the meter browser.

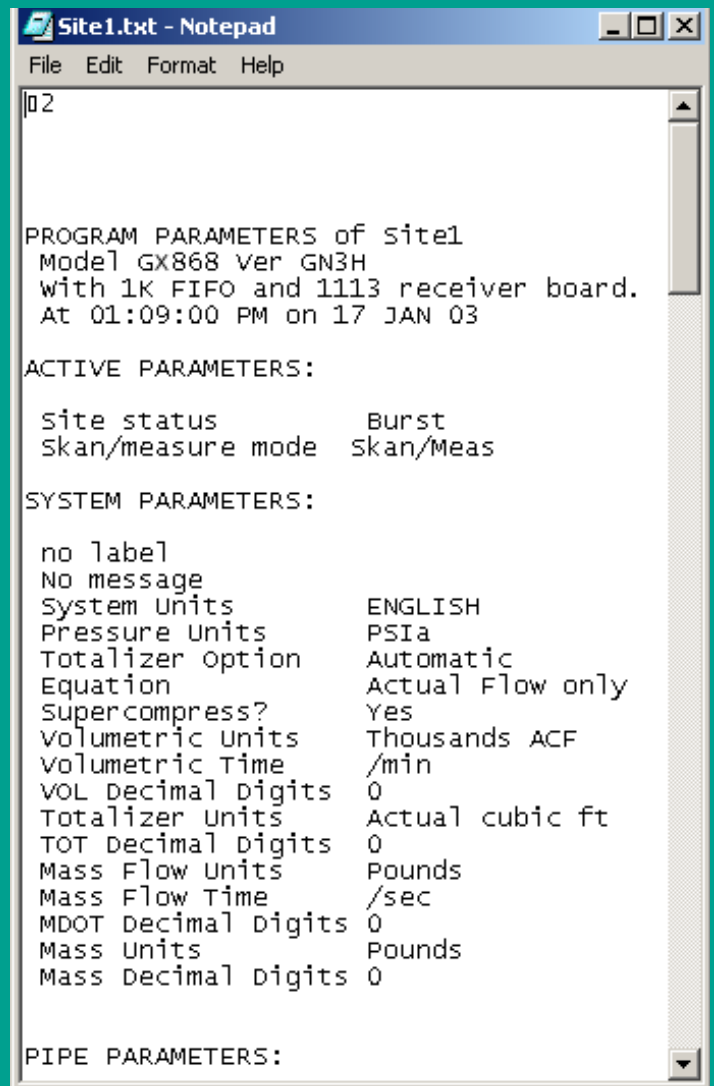

```
Site1.txt - Notepad
File Edit Format Help

02

PROGRAM PARAMETERS of Site1
Model GX868 Ver GN3H
with 1K FIFO and 1113 receiver board.
At 01:09:00 PM on 17 JAN 03

ACTIVE PARAMETERS:

site status           Burst
Skan/measure mode    Skan/Meas

SYSTEM PARAMETERS:

no label
No message
System Units          ENGLISH
Pressure Units        PSIA
Totalizer Option      Automatic
Equation              Actual Flow only
Supercompress?       Yes
Volumetric Units      Thousands ACF
volumetric Time       /min
VOL Decimal Digits   0
Totalizer Units       Actual cubic ft
TOT Decimal Digits   0
Mass Flow Units       Pounds
Mass Flow Time        /sec
MDOT Decimal Digits  0
Mass Units            Pounds
Mass Decimal Digits  0

PIPE PARAMETERS:
```

Figure 34: Printout of site file

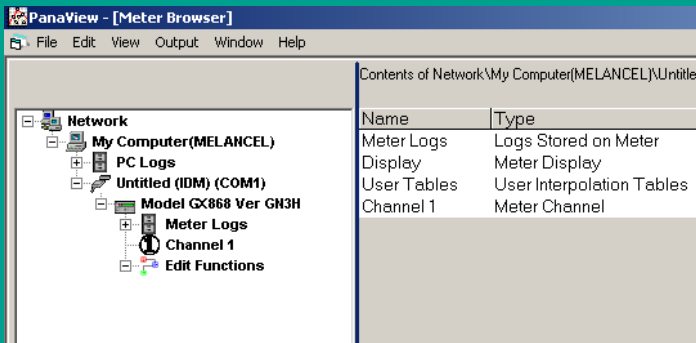

Figure 35: New meter browser with meter branch

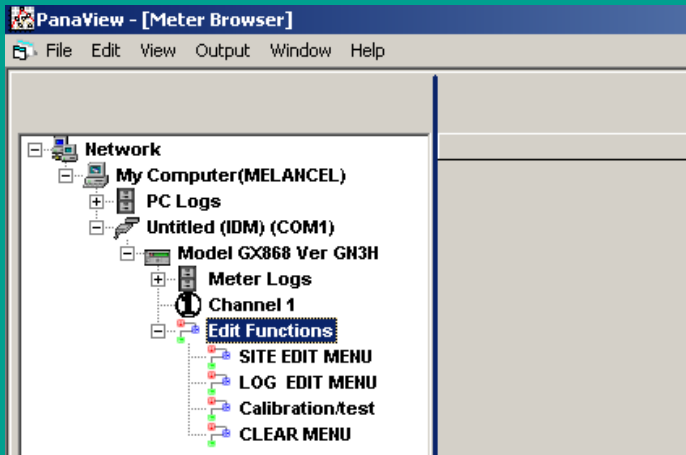

Figure 36: Meter tree with edit functions option

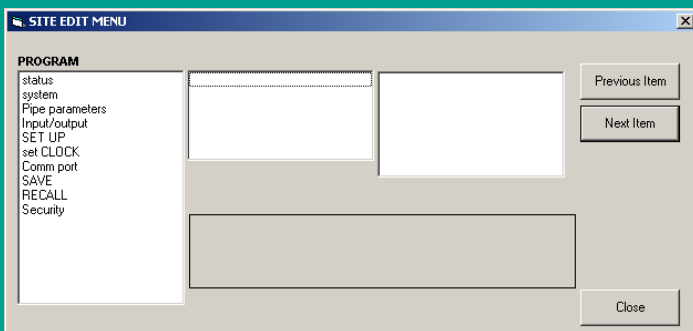

Figure 37: Site edit menu window

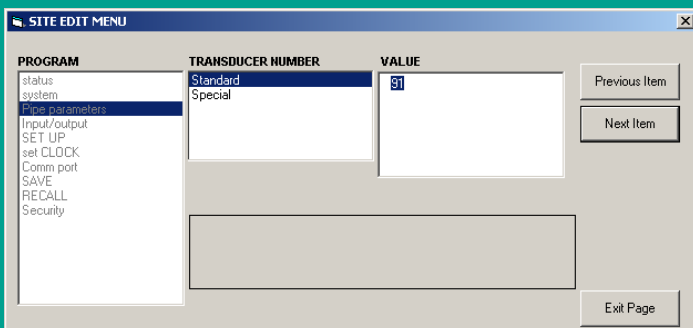

Figure 38: Pipe parameters option in site edit menu

C.6 Changing meter settings

Through PanaView, GF868 users can handle remote programming of the meter. They can:

- Program and change a meter’s operating parameters;
- Set up, start, and stop logs;
- Calibrate and test inputs and outputs;
- Clear various files.

To access meter programming:

1. Enter the *new meter browser* option from the “file” menu.
2. expand the network tree until you reach the desired meter.
3. Then expand the meter tree as shown in figure 35.
4. From the meter tree, expand the *edit functions* option. The window now appears similar to figure 36, with a list of available menus. The menus listed are those available on the meter.
5. To open a particular menu, double-click on that menu on the tree. For example, if you double-click on the site edit menu, a window opens similar to figure 37.

NOTE:

The options listed in the left pane correspond to the options available in the GX868 PROGRAM menus. For more information about the options in your instrument program and about appropriate parameters for the GF868, consult the previous chapters in this manual.

6. To enter a particular option:
 - a. Highlight and double-click on the desired option in the left pane. figure 38 shows the first entry (transducer number) in the *pipe parameters* option. The title above the center pane lists the current entry, while the center pane displays the available selections for that entry.
 - b. Click on the desired choice; if the entry requires a numeric value, change the value displayed in the right pane.
 - c. Do one of the following:

Click on [next item] to proceed to the next menu item,

or

Click on [previous item] to return back through the menu to a previous item.

NOTE:

If you click on either [next item] or [previous item] without changing the settings, the current settings remain unchanged.

As you step through the menu, the bottom panel lists the current settings you have modified or left unchanged (see figure 39). If you modify or step through more than five items, a scroll bar at the right of the panel lets you review the earlier settings.

7. When you have completed entering parameters in a given option, click [exit page] to close the option. You can then double-click on another option, or click [close] to close the window.

You can double-click on another menu to modify its settings, or return to the *new meter browser*. For additional PandaView functions, refer to the *PandaView user's manual*.

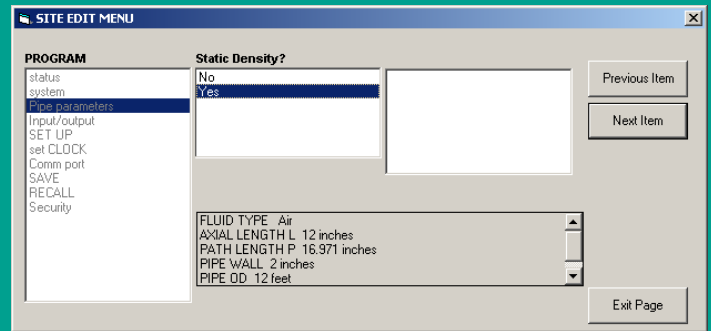

Figure 39: Site Edit menu with current settings

Appendix D. Foundation fieldbus communications

D.1 Optional measurements

Foundation fieldbus provides a means of communicating with the flowmeter. The patent numbers which apply are 5,909,363 and 6,424,872.

This foundation fieldbus device supports 6 analog input (AI) blocks, which can be configured to supply the following measurements on the network (see table 26).

Table 26: Available measurements Using a foundation fieldbus device					
Channel 1	Units	Channel 2	Units	Average	Units
Ch1 velocity	ft/s or m/s*	Ch2 velocity	ft/s or m/s*	Avg velocity	ft/s or m/s*
Ch1 act volumetric	VOL_U	Ch2 act volumetric	VOL_U	Avg act volumetric	VOL_U
Ch1 std volumetric	VOL_U	Ch2 std volumetric	VOL_U	Avg std volumetric	VOL_U
Ch1 fwd totals	TOT_U	Ch2 fwd totals	TOT_U	Avg fwd totals	TOT_U
Ch1 rev totals	TOT_U	Ch2 rev totals	TOT_U	Avg rev totals	TOT_U
Ch1 #tot digits**	none	Ch2 #tot digits**	none	Avg #tot digits**	none
Ch1 mass flow	MASS_U	Ch2 mass flow	MASS_U	Avg mass flow	MASS_U
Ch1 fwd mass totals	MTOT_U	Ch2 fwd mass totals	MTOT_U	Avg fwd mass totals	MTOT_U
Ch1 rev mass totals	MTOT_U	Ch2 rev mass totals	MTOT_U	Avg rev mass totals	MTOT_U
Ch1 #mass tot digits	none	Ch2 #mass tot digits	none	Avg #mass tot digits	none
Ch1 timer	sec	Ch2 timer	sec	Avg timer	sec
Ch1 error code	none	Ch2 error code	none	Avg error code	none
Ch1 SSUP	none	Ch2 SSUP	none	Avg SSUP	none
Ch1 SSDN	none	Ch2 SSDN	none	Avg SSDN	none
Ch1 sound speed	ft/s or m/s*	Ch2 sound speed	ft/s or m/s*	Avg sound speed	ft/s or m/s*
Ch1 density***	see note	Ch2 density***	see note		
Ch1 temperature	deg F or C*	Ch2 temperature	deg F or C*		
Ch1 pressure	PRESS_U	Ch2 pressure	PRESS_U		

*Metric or English units are determined by the setup of the flowmeter.

**Totalizer digits are available for informational purposes only. Respective totals are automatically scaled by the tot digits value selected in the flowmeter setup.

***If the meter is outputting mole weight, the unit is "mw", otherwise it is the programmed pressure unit.

VOL_U, TOT_U, MASS_U, MTOT_U and PRESS_U are determined by the units chosen for these measurements in the flowmeter setup. See the instrument user's manual for the setup of these parameters.

D.2 Configuration utility setup

The following is an example setup using national Instruments configuration utility v3.1. figure 40 shows the configuration utility with a flowmeter on the network (Panametrics Flow-XMT).

NOTE:

The following procedures assume that the device has been placed in the OOS (out-of-service) mode before executing.

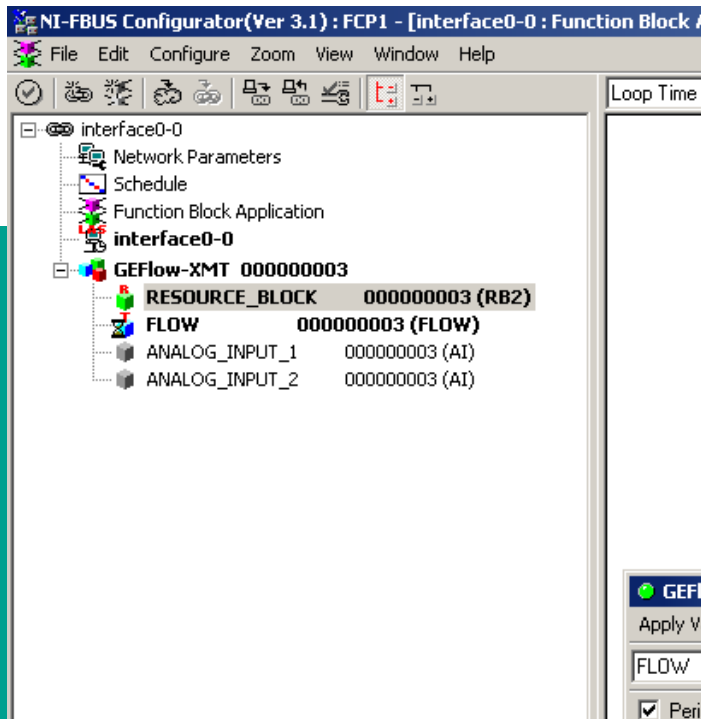

Figure 40: Configuration utility setup example

D.3 Selecting the desired measurements

To set the measurement unit for each AI:

1. Double click on the FLOW transducer block (in the tree under GEFLOW-XMT).
2. Select the **others** tab and open the drop down list for the PRIMARY_SELECTOR and SECONDARY_SELECTOR (see figure 41).
3. Choose the unit from the list (see figure 41).

This unit will correspond to the unit that is available in the AI block for network connection. The PRIMARY_SELECTOR unit will correspond to ANALOG_INPUT_1 and the SECONDARY_SELECTOR will correspond to ANALOG_INPUT_2.

4. After the desired measurements have been selected for the PRIMARY and SECONDARY SELECTOR, choose the unit system (UNIT_SELECTOR above the PRIMARY_SELECTOR) that has been programmed in the flowmeter (English or SI).

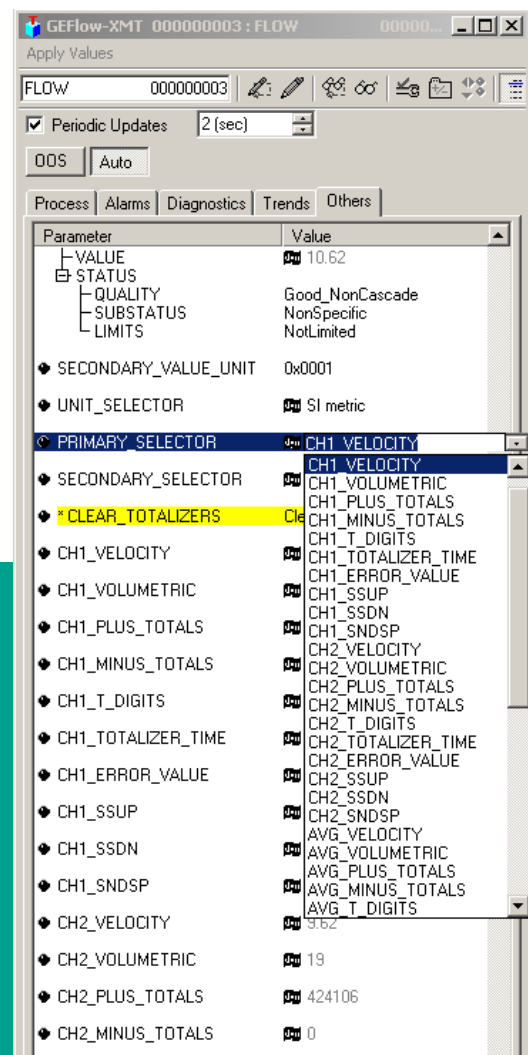

Figure 41: Primary selector drop down list

D.4 Selecting units for AI blocks

To select the units for the individual AI blocks:

1. Double click on the AI block for which you wish to set the units (ANALOG_INPUT_1 or ANALOG_INPUT_2 in the tree under GEFlow-XMT; see figure 40).
2. Select the **scaling** tab and set the unit for the measurement based on the flowmeter settings.

For example, if the flowmeter was set to use the metric unit system and the PRIMARY_SELECTOR was set to use VELOCITY you would choose m/s for the unit as shown in figure 42.

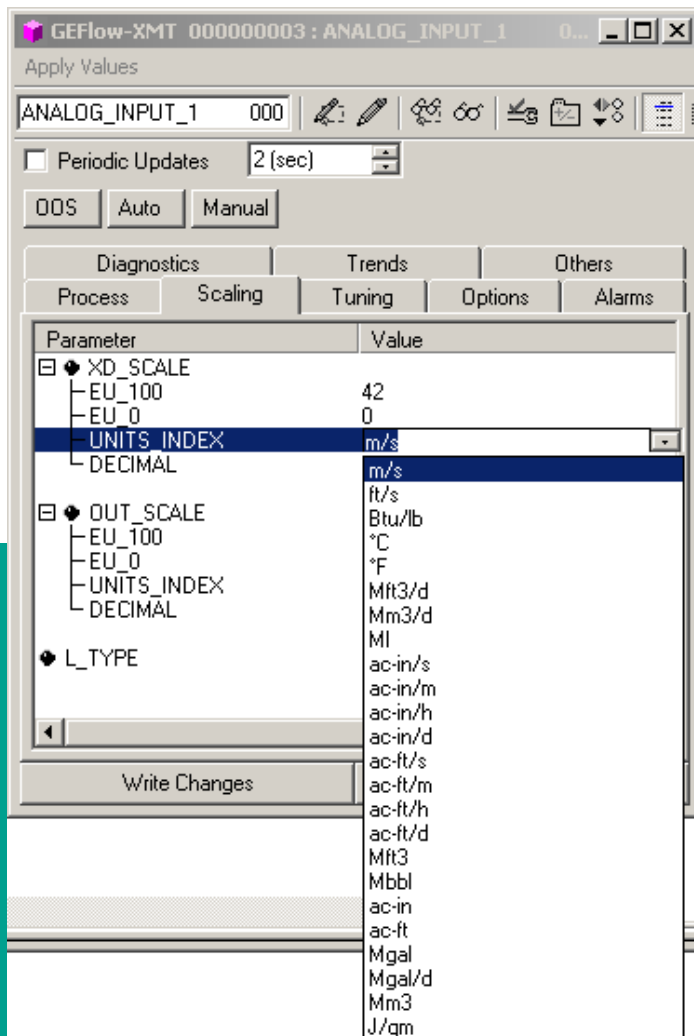

Figure 42: Units index drop down list

D.5 Resetting Instrument totalizers

To reset the instrument totalizers:

1. Double click on the FLOW transducer block (in the tree under GEFlow-XMT; see figure 40).
2. Select the **others** tab and scroll down to the CLEAR_TOTALIZERS listing.
3. Select **clear** from the drop down list box (see figure 43).
4. After the totals have been reset, select **normal** from the drop down list box to resume total accumulation.

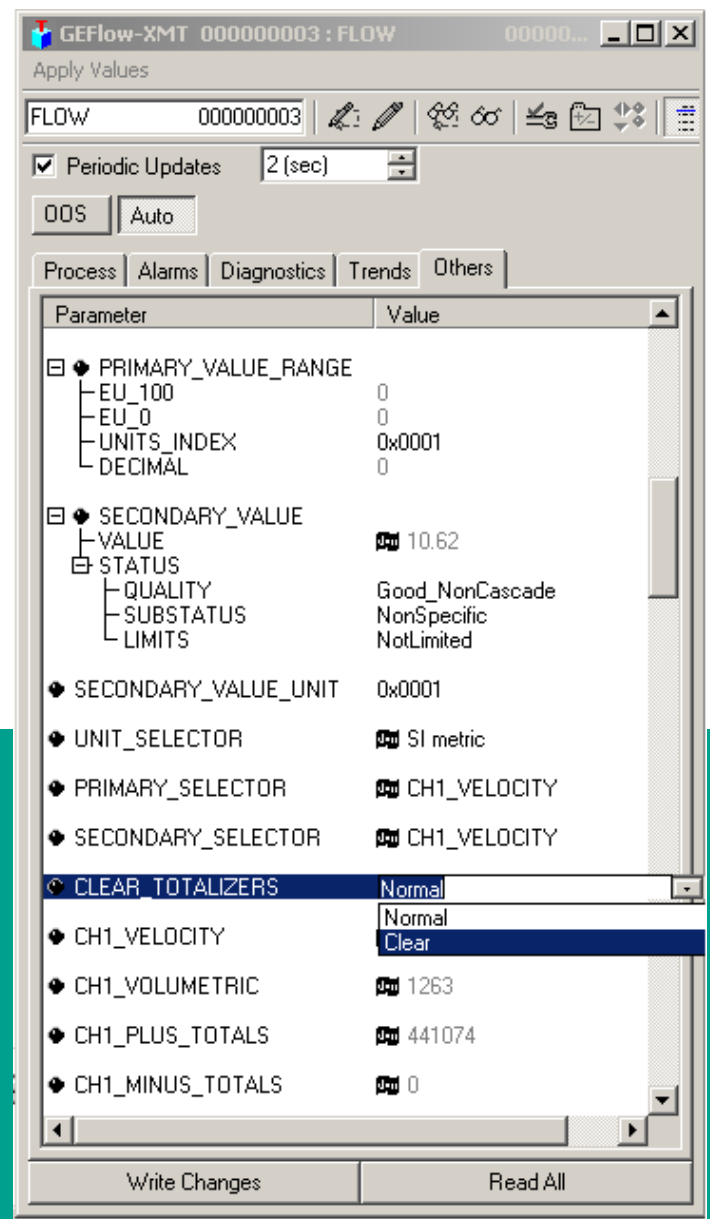

Figure 43: Clear totalizers drop down list

D.6 Function block application

Figure 44 is an example setup using the function block application editor. The flowmeter AI blocks, along with the AO and PID of another device on the network, are displayed. We have connected the AI_1 OUT of the flowmeter to the CAS IN of the AO block. We have also connected the AI_2 OUT of the flowmeter to the CAS IN of the PID block.

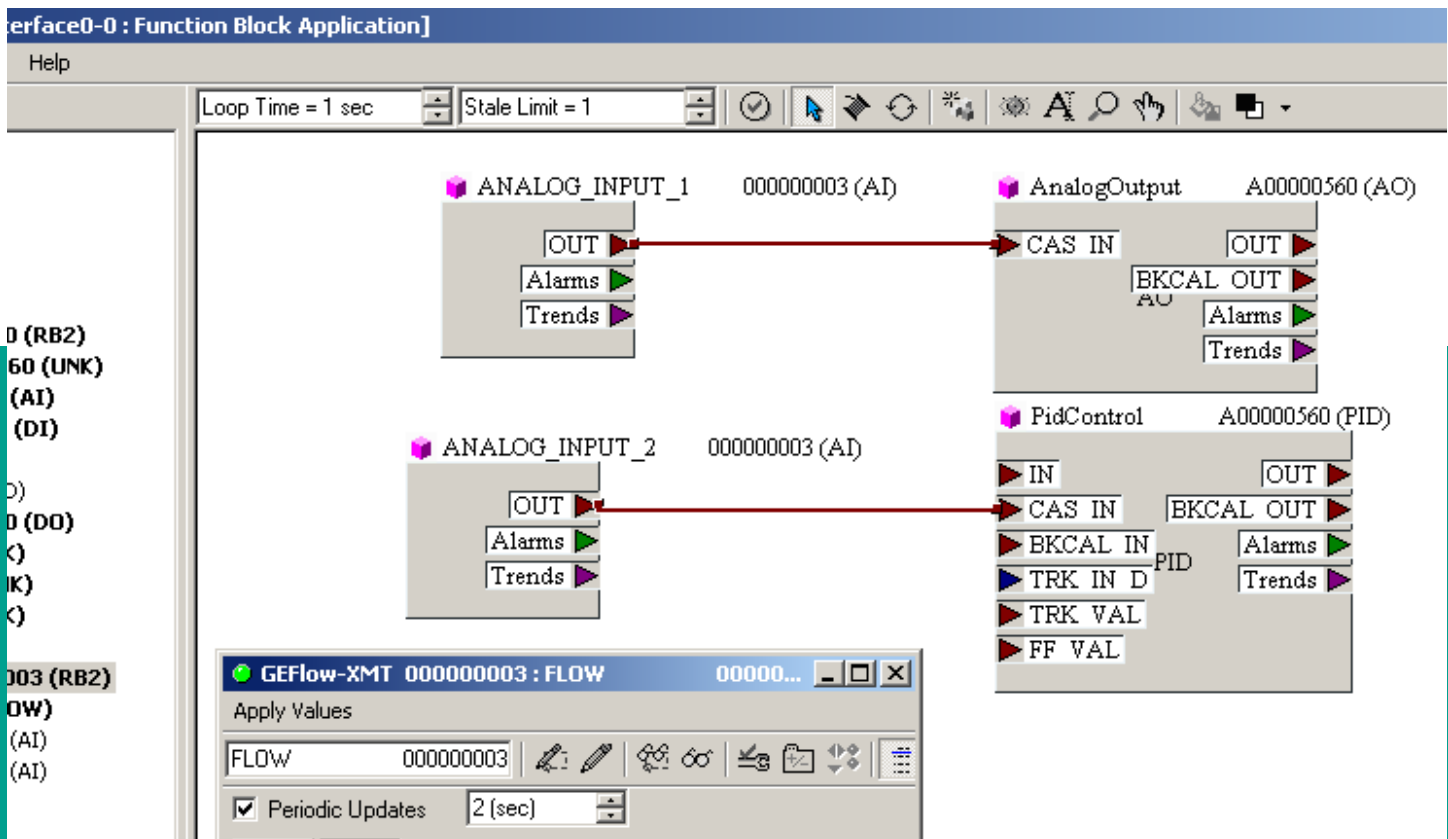

Figure 44: Function block application

Appendix E. Foundation fieldbus tables

Table 27: Panametrics fieldbus device capability, XGX868 family of meter types

Model		GF868, GS868, GM868, XGF868i, XGM868i, and XGS868i
1 – General		
1.1	Is the device registered at the fieldbus foundation (yes/no)	Yes
1.2	Is the unit released to production, and if not, when?	Yes
1.3	Is there any special functionality that device supports (e.g., display blocks, diagnostic blocks)?	No
1.4	Manufacturer name	Panametrics
1.5	Model	Panametrics & control gas flowmeter
1.6	Device type	0002
1.7	FF device revision	02
1.8	Does the device require special programming software to configure a 'good' status on the PV?	Yes
1.9	Does the device feature a non-volatile memory protection feature? If so, what are the steps to disable/enable from the resource or transducer block.	No
1.10	HOST system registered	Yokogawa (TBD), Emerson, Honeywell (TBD), ABB (TBD)
1.11	Design concept	Entity concept
1.12	FISCO compliant?	No
1.13	FNICO compliant?	Yes: models XGM868i, XGS868i, XGF868i; No: others
1.14	Hazardous location certs	GF868, GM868, GS868: CSA for non-incendive div 2, class 1, Gr A, B, C, & D. IP66 Optional: div 1, Class 1, Gr C & D or ATEX II 2 G Ex d IIC T6 IP66 or IECEX II2 G Ex d IIC T6 Gb IP66 XGM868i, XGS868i, XGF868i: CSA div 1, class 1, Gr B, C, & D and ATEX II 2 G D Ex d IIC T5 IP66 and IECEX II 2 G Ex d IIC T6 Gb IP66
1.15	FF liquid PCB p/n:	XMT868i / DF868
1.16	FF gas PCB p/n:	XGX868i / Gx868 703-1475-04 (rev J)/ 703-1491-04

Table 27: Panametrics fieldbus device capability, XGX868 family of meter types

Model		GF868, GS868, GM868, XGF868i, XGM868i, and XGS868i
1.17	Meter software version (minimum and higher)	GF868: GF3S; GM868:GM3Q; GS868: GS3N; GC868: GC4C; XGM868i: Y4DM; XGS868: Y4DS; XGF868i: Y4DF
1.18	Firmware on FF card version	868_GAS_FF_206
1.19	Interoperability test kit (ITK) revision	6.1.1
1.2	Protocol	H1
1.21	Protocol baud (bps)	31.25k
2 - DD and CFF		
2.1	Device description file name (.ffo and .sym) and rev	0203
2.2	Capabilities file name and rev	020101.cff
2.3	Methods (list all methods available)	none
3- Physical		
3.1	Polarity sensitive (yes / no)	Yes (protected from failure if installed incorrectly)
3.2	Quiescent current draw (mA)	10 mA idle / 18 mA max
3.3	Startup current draw (ma)	18 mA
3.32	Working voltage	9-32 VDC
3.33	Device minimum voltage	9 VDC
3.41	Device resistance (ohms) fieldbus terminal (+) to (-)	30 mega ohms increasing
3.42	Device resistance (ohms) fieldbus terminal (+) to ground	Open circuit > 20 MOhm
3.43	Device resistance (ohms) fieldbus terminal (-) to ground	Open circuit > 20 MOhm
3.51	Capacitance (microF) (+) to (-)	1 pF
3.52	Capacitance (microF) (+) to ground	634.7 pF
3.53	Capacitance (microF) (-) to ground	635.7 pF
3.6	4-wire device (if so, what AC/DC voltage, single or 3-phase)	Yes, (85-250 VAC 50/60 Hz, single phase or 12-28 VDC)
3.7	Connection type	Terminal block, 2-wire twisted pair

Table 27: Panametrics fieldbus device capability, XGX868 family of meter types

Model	GF868, GS868, GM868, XGF868i, XGM868i, and XGS868i	
4 - Comm		
4.1	Stack manufacturer	National Instruments
4.2	Does the device support backup LAS functionality? (If it does, then the functionality will be tested.)	No
4.3		
4.4	Total number of VCRs	20
4.5	Number of fixed VCRs for user configuration (publisher, subscriber, alarming, and trending)	1 fixed for system management, 19 variable for user configuration
5 - User layer general		
5.1	Function block application manufacturer	Fieldbus Inc.
5.2	Function blocks (list all type, but not including transducer)	6 - AI(e), 1 - PID(e), 2 -TB(c), 1 - RB2(e)
5.3	Device support block instantiation (yes/no)	No
5.4	Number of link Objects	20
5.5	Device support firmware upgrade over fieldbus segment? (yes/no)	No
5.6	Configuration write protect?	Hardware jumper only
5.7	Zero trim, sensor trim, factory recall/upgrade device master reset	None
6 - Resource block		
6.1	Block class (std, Enhanced, custom)	Enhanced
6.2	Special features	Detailed errors, supported modes, revision id and date
7 - Transducer blocks		
7.1	Transducer blocks based on which latest version of the FF spec	FF-902 FS 1.4
7.2	Block type	Flow/display
7.3	Block class (std, enhanced, custom) Does the device support methods in the resource and transducer blocks? (If it does, then the functionality will be tested.)	Custom/custom No
7.4	Special features besides methods (multiple VIEWS, etc.) Device specific advanced diagnostics	Multiple View3s and View4s Yes

Table 27: Panometrics fieldbus device capability, XGX868 family of meter types

Model	GF868, GS868, GM868, XGF868i, XGM868i, and XGS868i	
8 – Function blocks		
8.1	Does the device support custom function blocks? An example of custom block has profile number equal to or greater than 0x8000. A standard enhanced block has profile revision with 0XXXXX, where enhancement number upper byte is non-zero (e.g. 0x5500 is en)	No
8.2	Block type	AI/PID
8.3	Number available	6/1
8.4	Execution time (ms)	50/100
8.5	Block class (std, enhanced, custom)	Enhanced
8.6	Function block special features (e.g., configuration required for non-standard parameters by host)	None
9 – Channels		
	XD_SCALE and CHANNEL value	List by channel, unit code, enumerated description, and function block type (if applicable)
9.1	Channel 0	n/a
9.2	Channel 1	Channel 1 - "primary value"/"secondary value"
		AI block
		Units -
		1001 - degree Celsius
		1002 - degree Fahrenheit
		1034 - cubic meter (removed)
		1043 - cubic feet
		1053 - standard cubic foot
		1061 - m/s
		1067 - ft/s
		1088 - kilogram
		1092 - metric ton
		1094 - pound (mass)
		1095 - short ton

Table 27: Panametrics fieldbus device capability, XGX868 family of meter types

Model	GF868, GS868, GM868, XGF868i, XGM868i, and XGS868i
9 - Channels	
XD_SCALE and CHANNEL value	List by channel, unit code, enumerated description, and function block type (if applicable)
	1097 - kilograms per cubic meter
	1107 - pounds per cubic foot
	1142 - pounds per square inch absolute
	1143 - pounds per square inch gauge
	1324 - kilogram per hour
	1360 - standard cubic feet per minute
	1361 - standard cubic feet per hour
	1526 - standard cubic meter (20° 1 atm)
	1547 - kilopascal absolute
	1548 - kilopascal gauge
	1590 - bar gauge (replaced with 34002)
	1597 - bar absolute (replaced with 34001)
	1653 - cubic megafeet per day (replaced with 34005)
	33010 - thousands of actual cubic feet (changed to 34028)
	33015 - thousands of actual cubic meters (changed to 34033)
	33022 - thousands of standard cubic feet (changed to 34038)
	33026 - thousands of standard cubic meters (changed to 34043)
	33037 - millions of actual cubic feet (changed to 34004)
	33042 - millions of actual cubic meters (changed to 34009)
	33049 - millions of pounds (changed to 34003)
	33054 - millions of standard cubic feet (changed to 34014)
	33058 - millions of standard cubic meters (changed to 34023)
	33063 - standard cubic feet per day (changed to 34025)
	33064 - standard cubic feet per second (changed to 34026)

Table 27: Panametrics fieldbus device capability, XGX868 family of meter types

Model	GF868, GS868, GM868, XGF868i, XGM868i, and XGS868i
9 - Channels	
XD_SCALE and CHANNEL value	List by channel, unit code, enumerated description, and function block type (if applicable)
	33065 - thousands of pounds (changed to 34027)
	33066 - mole weight (changed to 34024)
	33067 - thousands of kilograms (removed)
	1322 - kilogram per second
	1323 - kilogram per minute
	1325 - kilogram per day
	1326 - metric ton per second
	1327 - metric ton per minute
	1328 - metric ton per hour
	1329 - metric ton per day
	1330 - pound per second
	1331 - pound per minute
	1332 - pound per hour
	1333 - pound per day
	1334 - short ton per second
	1335 - short ton per minute
	1336 - short ton per hour
	1337 - short ton per day
	1347 - cubic meter per second
	1348 - cubic meter per minute
	1349 - cubic meter per hour
	1350 - cubic meter per day
	1356 - cubic feet per second
	1357 - cubic feet per minute

Table 27: Panametrics fieldbus device capability, XGX868 family of meter types

Model	GF868, GS868, GM868, XGF868i, XGM868i, and XGS868i
9 - Channels	
XD_SCALE and CHANNEL value	List by channel, unit code, enumerated description, and function block type (if applicable)
	1358 - cubic feet per hour
	1359 - cubic feet per day
	1497 - cubic kilometer per second
	1498 - cubic megameter per second
	1501 - cubic kilometer per minute
	1502 - cubic megameter per minute
	1505 - cubic kilometer per hour
	1506 - cubic megameter per hour
	1509 - cubic kilometer per day
	1510 - cubic megameter per day
	1527 - standard cubic meter per second (20°, 1atm)
	1528 - standard cubic meter per minute(20°, 1atm)
	1529 - standard cubic meter per hour (20°, 1atm)
	1530 - standard cubic meter per day (20°, 1atm)
	34000 - Actual cubic meters
	34001 - bar absolute
	34002 - bar gauge
	34003 - million pounds
	34004 - millions of actual cubic feet
	34005 - millions of actual cubic feet per day
	34006 - millions of actual cubic feet per hour
	34007 - millions of actual cubic feet per minute
	34008 - millions of actual cubic feet per second
	34009 - millions of actual cubic meters

Table 27: Panametrics fieldbus device capability, XGX868 family of meter types

Model	GF868, GS868, GM868, XGF868i, XGM868i, and XGS868i
9 - Channels	
XD_SCALE and CHANNEL value	List by channel, unit code, enumerated description, and function block type (if applicable)
	34010 - millions of pounds per day
	34011 - millions of pounds per hour
	34012 - millions of pounds per minute
	34013 - millions of pounds per second
	34014 - millions of standard cubic feet
	34015 - millions of standard cubic feet per day
	34016 - millions of standard cubic feet per hour
	34017 - millions of standard cubic feet per minute
	34018 - millions of standard cubic feet per second
	34019 - millions of standard cubic meter per day
	34020 - millions of standard cubic meter per hour
	34021 - millions of standard cubic meter per minute
	34022 - millions of standard cubic meter per second
	34023 - millions of standard cubic meters
	34024 - mole weight
	34025 - standard cubic feet per day
	34026 - standard cubic feet per second
	34027 - thousand pounds
	34028 - thousands of actual cubic feet
	34029 - thousands of actual cubic feet per day
	34030 - thousands of actual cubic feet per hour
	34031 - thousands of actual cubic feet per minute
	34032 - thousands of actual cubic feet per second
	34033 - thousands of actual cubic meters

Table 27: Panametrics fieldbus device capability, XGX868 family of meter types

Model		GF868, GS868, GM868, XGF868i, XGM868i, and XGS868i
9 - Channels		
XD_SCALE and CHANNEL value	List by channel, unit code, enumerated description, and function block type (if applicable)	
	34034 - thousands of pounds per day	
	34035 - thousands of pounds per hour	
	34036 - thousands of pounds per minute	
	34037 - thousands of pounds per second	
	34038 - thousands of standard cubic feet	
	34039 - thousands of standard cubic feet per day	
	34040 - thousands of standard cubic feet per hour	
	34041 - thousands of standard cubic feet per minute	
	34042 - thousands of standard cubic feet per second	
	34043 - thousands of standard cubic meters	
	34044 - thousands of standard cubic meters per day	
	34045 - thousands of standard cubic meters per hour	
	34046 - thousands of standard cubic meters per minute	
	34047 - thousands of standard cubic meters per second	
9.3	Channel 2	Channel 2 - "primary value"/"secondary value"
		AI block
		Units -
		Same as channel 1

A		
ACTIV		
Submenu	9	
AVRG submenu	20	
B		
BACKL		
Automatic timeout	52	
Submenu	41, 52	
Backlight		
See BACKL		
Basic programming data	100	
Baud rate		
Available options	32	
Setting	32	
BIG		
Measurement parameter options	42	
Screen format	42	
Submenu	41, 42	
C		
Cables, RS232 interface	79	
CHI/CH2 menu	9	
Clear site from meter	115	
Clear Totalizers	113	
Clearing data	75	
CLOCK		
Menu map	24	
Submenu	24	
CLR menu map	75	
COMM		
Menu map	32	
Submenu	32	
Communications port, setting up	104, 105	
D		
DATA		
Submenu	64	
Data records	100	
Date, programming	24	
DISP		
Menu	41	
Displaying data		
BIG format	42	
Display menu	41	
DUAL format	43	
Graphical format	43	
Log file	46	
Log file display options	47, 48	
Log file, graphical format	48	
Log file, numeric format	47	
Numeric key functions	51	
SLEEP mode	52	
Transducer signals	49	
Typical SIGNAL display screen	50	
DUAL		
Screen format	43	
Submenu	41, 43	
E		
Edit functions option	118	
Edit menu	104	
ERROR		
Submenu	53, 60	
Error Handling		
2-path	27	
Response options	27	
ERROR menu	27	
Ethernet		
Setting up with PanaView	105	
Ethernet, setting up	87	
F		
Foundation fieldbus		
Available measurements	121	
Communications	121	
Function keys, GRAPH screen format	44	
G		
GLOBL		
Menu	23	
Submenus	23	
GRAPH		
Screen display options	44	
Screen format	43	
Setting up	43	
Submenu	41, 43	
Typical display screen	44	
Using function keys	44	
H		
Help, on-line	6	
I		
I/O (CHI/CH2)		
Menu map	14	
Submenu	14	
IDM-compatible meters	103	
INIT submenu	20	
Instrument data manager (IDM)	32	

K		N	
Keypad		Network ID number	32
Description	2	Numeric keys, displaying SIGNAL data	51
Using	2	O	
Keys		On-line help	6
Audio Alarm volume	7	Option card	
Console control	7	RTD inputs	31
Display backlight	7	Setup information table	99
Display contrast	7	OPTN menu	28
Stopwatch totalizer	7	P	
Table of functions	3	PanaView, Applications of	103
Kinematic viscosity	13, 21	Password	
L		Default	36
LOG		Entering	36
Entering the submenu	46	PIPE	
Menu map	46	Submenu	12
Submenu	41, 46, 67, 78	Pipe wall, Entering	13
Log file		Plotting signal	113
Header	53	Printer	
Pages of memory	53	Acceptable models	71
Records	53	Interface	71
Logging data	53	Setting up	71
Calculating number of pages	58	Printing data	
Calculating number of Records	58	Live data, graphical format	65
Circular	55	Logged data, graphical format	69
Measurement parameter options	54	Logged data, numeric format	67
Menu	53	Measurement parameter options	64
Non-Circular	55	sample printout, live graphical	66
Time Increment	57	Sample printout, live numeric	65
M		Sample printout, logged graphical	69
Measure mode	9	Sample printout, logged numeric	67
Measurements, foundation fieldbus	121	Sample printout, signal array	73
MEM submenu	53, 58	Sample printout, site data	70
Menu		Serial port	63
See menu name		Site file	70
Menu map		PRNT	
CLR	75	Menu	63
LOG submenu	46	PRNTR	
PRNTR submenu	71	Menu map	71
SGNLS submenu	73	Submenu	71
STOP submenu	71	PROG	
Menus, Edit	104	Menu map	70
Meter settings, changing	117	Submenu	70
MODBUS		Programming mode, entering	8
Register map for	33	Properties option in Edit menu	109
MODBUS/TCP			
Setting up	88		

R		Signal
RECLL		Graph..... 113
Menu..... 39		Plot..... 113
Menu map..... 39		Reading..... 112
Return policy..... 139		Save..... 113
Reynolds correction..... 13		Type..... 112
RS232 interface		Signal array data, printing..... 73
Baud rate..... 80		SIGNL
Cable connections..... 79		Submenu..... 41, 49
COM ports..... 79		Typical display screen..... 50
Hyperterminal..... 82		SIGNL option..... 16
Pin Assignments..... 79		Site Edit menu..... 118
Terminal software..... 81		Site file operations..... 114
Windows 3.X systems..... 81		Site files, Handling..... 114
Windows 9X/NT systems..... 82		SITE submenu..... 77
Wiring..... 79		Skam mode..... 9
RS485 interface		SLEEP submenu..... 41, 52
Converter mounting..... 83		STD submenu..... 53, 54
Converter Switch settings..... 86		STOP
Multi-point wiring..... 84		Menu map..... 71
Point-to-point wiring..... 84		Submenu..... 53, 59, 71
Reconfiguring converter..... 85		Stopwatch totalizer, programming..... 25
RS232 converter..... 83		Submenu
RTD inputs card, setting up..... 31		See submenu name
S		System units, Entering..... 25
SAVE		T
Menu..... 38		TOTAL submenu..... 76
Menu map..... 38		Transducer
Save site print to PC..... 116		Special..... 12
Save site to meter..... 114		Transducer signals
Save site to PC..... 115		Display options..... 49
SECUR		Displaying..... 49
Menu..... 36		U
Submenus..... 36		User Program
Serial communications		Accessing..... 8
Baud rate..... 32		Exiting..... 31
COMM menu..... 32		Submenu..... 1
Network ID number..... 32		V
SETUP		Volumetric units options..... 10
Submenu..... 16		Selecting..... 10
SGNLS		W
Menu map..... 73		Warranty..... 139
Submenu..... 73		

Warranty

Each instrument manufactured by Panametrics is warranted to be free from defects in material and workmanship. Liability under this warranty is limited to restoring the instrument to normal operation or replacing the instrument, at the sole discretion of Panametrics. Fuses and batteries are specifically excluded from any liability. This warranty is effective from the date of delivery to the original purchaser. If Panametrics determines that the equipment was defective, the warranty period is:

- one year from delivery for electronic or mechanical failures
- one year from delivery for sensor shelf life

If Panametrics determines that the equipment was damaged by misuse, improper installation, the use of unauthorized replacement parts, or operating conditions outside the guidelines specified by Panametrics, the repairs are not covered under this warranty.

The warranties set forth herein are exclusive and are in lieu of all other warranties whether statutory, express or implied (including warranties or merchantability and fitness for a particular purpose, and warranties arising from course of dealing or usage or trade).

Return policy

If a Panametrics instrument malfunctions within the warranty period, the following procedure must be completed:

1. Notify Panametrics, giving full details of the problem, and provide the model number and serial number of the instrument. If the nature of the problem indicates the need for factory service, Panametrics will issue a RETURN AUTHORIZATION NUMBER (RAN), and shipping instructions for the return of the instrument to a service center will be provided.
2. If Panametrics instructs you to send your instrument to a service center, it must be shipped prepaid to the authorized repair station indicated in the shipping instructions.
3. Upon receipt, Panametrics will evaluate the instrument to determine the cause of the malfunction.

Then, one of the following courses of action will then be taken:

- If the damage is covered under the terms of the warranty, the instrument will be repaired at no cost to the owner and returned.
- If Panametrics determines that the damage is not covered under the terms of the warranty, or if the warranty has expired, an estimate for the cost of the repairs at standard rates will be provided. Upon receipt of the owner's approval to proceed, the instrument will be repaired and returned.

[no content intended for this page]

Panametrics infrastructure products used in hazardous locations

Installation and operation manuals in their complete forms, along with product specific certification and safety statement sheets are included on the CD provided with the product documentation shipped with each instrument. Please read and follow all provided manufacturer's instructions prior to installation and the application of power to your equipment. Always observe the following:

- Field wiring shall be rated at least 10°C above rated ambient.
- Connecting cables shall be mounted securely and protected from mechanical damage, pulling and twisting.
- Cable entry thread types are identified on the equipment label.
- Cable glands of an approved flameproof design are required for **Ex d** rated equipment. These must be installed according to the manufacturer's instructions. Where the cable glands are provided by Panametrics, the manufacturer's instructions, as supplied to Panametrics, will be included in the documentation.
- Unused cable entries must be sealed using a suitably certified threaded plug.
- Modifications to any flameproof enclosure are not permitted.
- The apparatus must be de-energized before opening, servicing and conducting any routine maintenance.
- Installation shall be in accordance with the installation instructions and the National Electrical code® ANSI/NFPA 70, the Canadian Electrical code C22.1, or IEC/EN 60079-14, as applicable.
- The product contains no exposed parts which produce surface temperature infrared, electromagnetic ionizing, or non-electrical dangers.
- The product must not be subjected to mechanical or thermal stresses in excess of those permitted in the certification documentation and the instruction manual.
- The product cannot be repaired by the user. It must be replaced by an equivalent certified product. Repairs should only be carried out by the manufacturer or by an approved repairer.
- Only trained, competent personnel may install, operate and maintain the equipment.
- The product is an electrical apparatus and must be installed in the hazardous area in accordance with the requirements of the *EC type examination certificate*. The installation must be carried out in accordance with all the appropriate international, national and local standard codes and practices and site regulations for flameproof apparatus and in accordance with the instructions contained in the manual. Access to the circuitry must not be made during operation.

Special conditions for safe use

- 1 Consult the manufacturer if dimensional information on any flameproof joint is necessary.
- 2 Follow the manufacturer's instructions to reduce the potential of an electrostatic charging hazard.
- 3 Consult the manufacturer for genuine replacement flange fasteners. M10x35 hexagon socket cap screws of ISO 12.9 DIN912 grade steel (zinc-plated) or better with a minimum yield strength of 135,000 psi are acceptable alternatives.
- 4 The sensor body temperature code rating is dependent on the process temperature. It is assumed that the external surface of the sensor body will be, at worst case, equal to the process temperature (up to 140°C). In all cases, the electronics assembly will be marked T6 as it will be locally mounted for process temperatures up to 85°C and will be remotely mounted for process temperatures exceeding 85°C.

Markings

Markings appear on the instrument label which identifies the product model, serial number, operating ranges, hazardous area ratings, entry thread type, and warning and caution information.

EU / EEA installation compliance

The use of this apparatus is subject to the EU directive on minimum requirements for improving the safety and health protection of workers potentially at risk from explosive atmospheres, council directive 1999/92/EC. The installer is required to be familiar with this document or the national transposing legislation.

Increased safety wiring connections

Power connection:

Maximum size ‡:	Solid - 4.0 mm ² (12 AWG) Stranded - 2.5 mm ² (14 AWG)
Number of conductors†:	2 Solid - max 1.5mm ² (16 AWG) 2 stranded - max 1.0 mm ² (18 AWG)

All other screw terminal connections:

Maximum size ‡:	Solid - 4.0 mm ² (12 AWG) Stranded - 2.5 mm ² (14 AWG)
Number of conductors†:	2 Solid - max 1.5mm ² (16 AWG) 2Stranded - max 1.0 mm ² (18 AWG)

‡ - Single conductor

† - Multi-conductors of same cross-section

Customer support centers

Americas

The Boston Center

The Boston Center
1100 Technology Park Drive
Billerica, MA 01821
U.S.A.
Tel: 800 833 9438 (toll-free)
978 437 1000

E-mail: panametricstechsupport@bakerhughes.com

Europe

Ireland

Sensing House
Shannon Free Zone East
Shannon, County Clare Ireland
Tel: +353 61 61470200

E-mail: panametricstechsupport@bakerhughes.com

Panametrics, a Baker Hughes Business, provides solutions in the toughest applications and environments for moisture, oxygen, liquid and gas flow measurement. Experts in flare management, Panametrics technology also reduces flare emissions and optimizes performance.

With a reach that extends across the globe, Panametrics' critical measurement solutions and flare emissions management are enabling customers to drive efficiency and achieve carbon reduction targets across critical industries including: Oil & Gas; Energy; Healthcare; Water and Wastewater; Chemical Processing; Food & Beverage and many others.

Join the conversation and follow us on LinkedIn
[linkedin.com/company/panametricscompany](https://www.linkedin.com/company/panametricscompany)